

**HBA**

**WENTYLATOR ŚCIENNY, RÓŻNE KĄTY ŁOPATEK**
**CECHY:**

- Wzmocniona obudowa wentylatora wykonana z blachy ze stali walcowanej.
- Uniwersalny modułowy zespół silnik-wirnik.
- Powłoka epoksydowa nakładana proszkowo.
- Standardowy asynchroniczny silnik klatkowy, stopień ochrony IP55, izolacja klasy F. Standardowe napięcia zasilania: 230V, 50 Hz dla silników jednofazowych, 230/400V, 50 Hz dla silników trójfazowych do 4 kW i 400/690V, 50 Hz dla silników o większych mocach.
- HB : Wirnik poliamidowy wzmocniony włóknem szklanym, różne kąty pochylenia łopatek wirnika.
- HBA : Wirnik aluminiowy, różne kąty pochylenia łopatek wirnika.

**ZASTOSOWANIE:**

Zaprojektowane do montażu ściennego lub kanałowego.

Odpowiednie dla:

- Wentylacji obiektów mieszkalnych i przemysłowych.
- Maksymalnej temperatury roboczej: 50°C dla silników jednofazowych, 60°C dla silników trójfazowych.

**NA ŻĄDANIE:**

- Wirnik nawiewny typu B (przepływ powietrza od wirnika do silnika), wirnik rewersyjny.
- 100% rewersyjność wirnika.
- Wentylatory 60 Hz i specjalne napięcia zasilania.
- Obudowa z blachy ocynkowanej na gorąco lub ze stali nierdzewnej.

**Akcesoria**

**AC**

**CPM**

**FILTRO  
EMC**

**INT**

**MC HB**

**PC2**

**PCP**

**RP0**

**RP1**

**SFC**

## Dane techniczne

### Silnik jednofazowy / 2-biegunowy

Kod	Model	R.P.M.	Natężenie I (400V) A	Moc nominalna kW	Maks. Przepływ m3/h	Hałas db (A)*	Masa	Schemat połączenia
26036306__A	HBA 35 M2 0,55kW (A0:6)	2800	3,71	0,55	4.690	59	13	1
26039306__A	HBA 35 M2 1,1kW (A0:6)	2800	6,71	1,10	5.760	57	13	1

### Silnik jednofazowy / 4-biegunowy

Kod	Model	R.P.M.	Natężenie I (400V) A	Moc nominalna kW	Maks. Przepływ m3/h	Hałas db (A)*	Masa	Schemat połączenia
26035306__A	HBA 35 M4 0,12kW (A0:6)	1380	1,15	0,12	3.100	42	9	1
26040306__A	HBA 40 M4 0,25kW (A0:6)	1400	1,93	0,25	4.690	48	14	1
26045306__A	HBA 45 M4 0,37kW (A0:6)	1400	2,82	0,37	6.610	53	15	1
26050306__A	HBA 50 M4 0,55kW (A0:6)	1400	3,98	0,55	9.320	52	21	1
26057356__A	HBA 56 M4 0,37kW (A5:6)	1400	2,82	0,37	7.230	58	41	1
-	HBA 56 M4 0,55kW (A2:6)	1400	3,98	0,55	8.290	56	43	1
-	HBA 56 M4 0,55kW (A2:6)	1400	3,98	0,55	8.290	56	43	1
26058356__A	HBA 56 M4 0,55kW (A5:6)	1400	3,98	0,55	8.680	58	43	1

### Silnik jednofazowy / 6-biegunowy

Kod	Model	R.P.M.	Natężenie I (400V) A	Moc nominalna kW	Maks. Przepływ m3/h	Hałas db (A)*	Masa	Schemat połączenia
26043306__A	HBA 40 M6 0,04kW (A0:6)	920	0,6	0,04	2.760	36	10	1
26049306__A	HBA 45 M6 0,13kW (A0:6)	920	1,3	0,13	4.710	41	12	1
26052306__A	HBA 50 M6 0,13kW (A0:6)	920	1,3	0,13	6.040	43	19	1
-	HBA 56 M6 0,25kW (A2:6)	870	2,42	0,25	7.710	45	41	1
-	HBA 56 M6 0,25kW (A2:6)	870	2,42	0,25	7.710	45	41	1
26056356__A	HBA 56 M6 0,25kW (A5:6)	870	2,42	0,25	7.700	47	41	1
26057326__A	HBA 56 M6 0,37kW (A2:6)	890	2,9	0,37	9.000	46	41	1
26057356__A	HBA 56 M6 0,37kW (A5:6)	890	2,9	0,37	8.770	47	41	1
26063356__A	HBA 63 M6 0,37kW (A5:6)	890	2,9	0,37	10.760	49	43	1
26064329__A	HBA 63 M6 0,55kW (A2:9)	890	3,9	0,55	11.900	49	48	1
26064356__A	HBA 63 M6 0,55kW (A5:6)	890	3,9	0,55	12.050	49	44	1
26071326__A	HBA 71 M6 0,55kW (A2:6)	890	3,9	0,55	15.500	49	46	1
26071329__A	HBA 71 M6 0,55kW (A2:9)	890	3,9	0,55	12.700	53	46	1

## Silnik trójfazowy / 2-biegunowy

Kod	Model	R.P.M.	Natężenie I (400V) A	Moc nominalna kW	Maks. Przepływ m <sup>3</sup> /h	Hałas db (A)*	Masa	Schemat połączenia
26036606__A	HBA 35 T2 0,55kW (A0:6)	2800	1,29	0,55	4.690	59	13	2
26039606__A	HBA 35 T2 1,1kW (A0:6)	2800	2,33	1,10	5.760	57	13	2
26042606__A	HBA 40 T2 1,1kW (A0:6)	2800	2,33	1,10	7.850	61	20	2
26046606__A	HBA 45 T2 1,5kW (A0:6)	2800	3,14	1,50	9.560	68	23	2
26048606__A	HBA 45 T2 2,2kW (A0:6)	2800	4,58	2,20	12.160	63	26	2

## Silnik trójfazowy / 4-biegunowy

Kod	Model	R.P.M.	Natężenie I (400V) A	Moc nominalna kW	Maks. Przepływ m <sup>3</sup> /h	Hałas db (A)*	Masa	Schemat połączenia
26035606__A	HBA 35 T4 0,12kW (A0:6)	1400	0,46	0,12	3.100	42	9	2
26040606__A	HBA 40 T4 0,25kW (A0:6)	1400	0,79	0,25	4.690	48	14	2
26047606__A	HBA 45 T4 0,55kW (A0:6)	1400	1,49	0,55	7.260	50	15	2
26050606__A	HBA 50 T4 0,55kW (A0:6)	1400	1,49	0,55	9.320	52	21	2
26057656__A	HBA 56 T4 0,37kW (A5:6)	1400	1,07	0,37	7.230	58	41	2
26058626__A	HBA 56 T4 0,55kW (A2:6)	1400	1,49	0,55	8.290	56	43	2
26058629__A	HBA 56 T4 0,55kW (A2:9)	1400	1,49	0,55	6.590	56	46	2
26058656__A	HBA 56 T4 0,55kW (A5:6)	1400	1,49	0,55	8.680	58	43	2
26059626__A	HBA 56 T4 0,75kW (A2:6)	1390	1,63	0,75	10.500	54	44	2
26059629__A	HBA 56 T4 0,75kW (A2:9)	1390	1,63	0,75	8.170	56	45	2
26059656__A	HBA 56 T4 0,75kW (A5:6)	1390	1,63	0,75	10.810	57	44	2
26060626__A	HBA 56 T4 1,1kW (A2:6)	1400	2,49	1,10	12.900	54	45	2
26060629__A	HBA 56 T4 1,1kW (A2:9)	1400	2,49	1,10	11.700	57	48	2
26060656__A	HBA 56 T4 1,1kW (A5:6)	1400	2,49	1,10	12.520	56	45	2
26061626__A	HBA 56 T4 1,5kW (A2:6)	1400	3,26	1,50	13.900	56	48	2
26061629__A	HBA 56 T4 1,5kW (A2:9)	1400	3,26	1,50	13.600	57	50	2
26061656__A	HBA 56 T4 1,5kW (A5:6)	1400	3,26	1,50	13.560	57	47	2
26064626__A	HBA 63 T4 0,55kW (A2:6)	1400	1,49	0,55	9.020	54	44	2
26065626__A	HBA 63 T4 0,75kW (A2:6)	1390	1,63	0,75	11.400	57	45	2
26065629__A	HBA 63 T4 0,75kW (A2:9)	1390	1,63	0,75	9.120	59	49	2
26065656__A	HBA 63 T4 0,75kW (A5:6)	1390	1,63	0,75	12.020	60	45	2
26066626__A	HBA 63 T4 1,1kW (A2:6)	1400	2,49	1,10	15.000	56	49	2
26066629__A	HBA 63 T4 1,1kW (A2:9)	1400	2,49	1,10	11.700	59	53	2
26066656__A	HBA 63 T4 1,1kW (A5:6)	1400	2,49	1,10	14.740	61	49	2
26067626__A	HBA 63 T4 1,5kW (A2:6)	1400	3,26	1,50	18.300	56	51	2
26067629__A	HBA 63 T4 1,5kW (A2:9)	1400	3,26	1,50	15.700	59	55	2
26067656__A	HBA 63 T4 1,5kW (A5:6)	1400	3,26	1,50	16.610	57	51	2

Kod	Model	R.P.M.	Natężenie I (400V) A	Moc nominalna kW	Maks. Przepływ m <sup>3</sup> /h	Hałas db (A)*	Masa	Schemat połączenia
26068626__A	HBA 63 T4 2,2kW (A2:6)	1430	4,64	2,20	20.100	57	52	2
26068629__A	HBA 63 T4 2,2kW (A2:9)	1430	4,64	2,20	20.300	60	56	2
26068656__A	HBA 63 T4 2,2kW (A5:6)	1430	4,64	2,20	18.630	58	52	2
26069629__A	HBA 63 T4 3kW (A2:9)	1430	6,17	3	21.800	60	57	2
26072626__A	HBA 71 T4 0,75KW (A2:6)	1390	1,63	0,75	12.000	63	50	2
26072656__A	HBA 71 T4 0,75kW (A5:6)	1390	1,63	0,75	13.630	65	51	2
26073626__A	HBA 71 T4 1,1kW (A2:6)	1400	2,49	1,10	15.500	62	53	2
26073629__A	HBA 71 T4 1,1kW (A2:9)	1400	2,49	1,10	12.100	65	55	2
26073656__A	HBA 71 T4 1,1kW (A5:6)	1400	2,49	1,10	16.800	64	53	2
26074626__A	HBA 71 T4 1,5kW (A2:6)	1400	3,26	1,50	20.800	60	55	2
26074629__A	HBA 71 T4 1,5kW (A2:9)	1400	3,26	1,50	15.700	64	57	2
26074656__A	HBA 71 T4 1,5kW (A5:6)	1400	3,26	1,50	19.960	63	55	2
26075626__A	HBA 71 T4 2,2kW (A2:6)	1430	4,64	2,20	25.300	59	60	2
26075629__A	HBA 71 T4 2,2kW (A2:9)	1430	4,64	2,20	21.600	63	61	2
26075656__A	HBA 71 T4 2,2kW (A5:6)	1430	4,64	2,20	23.200	61	60	2
26076626__A	HBA 71 T4 3kW (A2:6)	1430	6,17	3	27.900	60	62	2
26076629__A	HBA 71 T4 3kW (A2:9)	1430	6,17	3	25.300	63	64	2
26076656__A	HBA 71 T4 3kW (A5:6)	1430	6,17	3	25.160	63	62	2
26081626__A	HBA 80 T4 1,1KW (A2:6)	1400	2,49	1,10	15.400	63	50	2
26082626__A	HBA 80 T4 1,5KW (A2:6)	1400	3,26	1,50	20.300	63	54	2
26082629__A	HBA 80 T4 1,5KW (A2:9)	1400	3,26	1,50	16.200	71	55	2
26083626__A	HBA 80 T4 2,2kW (A2:6)	1430	4,64	2,20	27.900	63	63	2
26083629__A	HBA 80 T4 2,2kW (A2:9)	1430	4,64	2,20	21.200	69	66	2
26084626__A	HBA 80 T4 3kW (A2:6)	1430	6,17	3	32.500	62	67	2
26084629__A	HBA 80 T4 3kW (A2:9)	1430	6,17	3	26.400	67	70	2
26084656__A	HBA 80 T4 3kW (A5:6)	1430	6,17	3	31.090	63	67	2
26085626__A	HBA 80 T4 4kW (A2:6)	1440	8,32	4	36.100	62	78	2
26085629__A	HBA 80 T4 4kW (A2:9)	1440	8,32	4	31.900	66	80	2
26085656__A	HBA 80 T4 4kW (A5:6)	1440	8,32	4	34.000	64	78	2
26086626__A	HBA 80 T4 5,5kW (A2:6)	1440	10,5	5,50	39.000	62	80	2
26086629__A	HBA 80 T4 5,5kW (A2:9)	1440	10,5	5,50	38.200	65	83	2
26093663__A	HBA 90 T4 3kW (A6:3)	1430	6,17	3	30.700	61	74	2
26094663__A	HBA 90 T4 4kW (A6:3)	1440	8,32	4	37.700	64	85	2
26095663__A	HBA 90 T4 5,5kW (A6:3)	1440	10,5	5,50	41.400	67	89	2
26095666__A	HBA 90 T4 5,5kW (A6:6)	1440	10,5	5,50	33.400	71	93	2
26096663__A	HBA 90 T4 7,5kW (A6:3)	1440	14,1	7,50	45.700	68	101	2
26096666__A	HBA 90 T4 7,5kW (A6:6)	1440	14,1	7,50	40.800	72	106	2
26097663__A	HBA 90 T4 11kW (A6:3)	1460	21,2	11	49.700	70	142	2
26097666__A	HBA 90 T4 11kW (A6:6)	1460	21,2	11	48.700	69	146	2

Kod	Model	R.P.M.	Natężenie I (400V) A	Moc nominalna kW	Maks. Przepływ m3/h	Hałas db (A)*	Masa	Schemat połączenia
26098666__A	HBA 90 T4 15kW (A6:6)	1460	29,8	15	56.500	69	166	2
26014663__A	HBA 100 T4 5,5kW (A6:3)	1440	10,5	5,50	48.700	68	98	2
26015663__A	HBA 100 T4 7,5kW (A6:3)	1440	14,1	7,50	55.500	68	112	2
26015666__A	HBA 100 T4 7,5kW (A6:6)	1440	14,1	7,50	44.200	76	115	2
26016663__A	HBA 100 T4 11kW (A6:3)	1460	21,2	11	63.000	69	152	2
26016666__A	HBA 100 T4 11kW (A6:6)	1460	21,2	11	56.200	76	157	2
26017663__A	HBA 100 T4 15kW (A6:3)	1460	29,8	15	67.100	71	178	2
26017666__A	HBA 100 T4 15kW (A6:6)	1460	29,8	15	63.500	75	181	2
26018666__A	HBA 100 T4 18,5kW (A6:6)	1465	35,6	18,50	71.200	73	221	2
26019666__A	HBA 100 T4 22kW (A6:6)	1470	40,1	22	78.300	73	230	2
26023663__A	HBA 112 T4 5,5kW (A6:3)	1440	10,5	5,50	52.700	73	115	2
26024663__A	HBA 112 T4 7,5kW (A6:3)	1440	14,1	7,50	63.400	74	125	2
26025663__A	HBA 112 T4 11kW (A6:3)	1460	21,2	11	72.600	73	162	2
26025666__A	HBA 112 T4 11kW (A6:6)	1460	21,2	11	55.700	78	168	2
26026663__A	HBA 112 T4 15kW (A6:3)	1460	29,8	15	83.600	73	183	2
26026666__A	HBA 112 T4 15kW (A6:6)	1460	29,8	15	72.700	77	188	2
26027663__A	HBA 112 T4 18,5kW (A6:3)	1465	35,6	18,50	87.300	74	220	2
26027666__A	HBA 112 T4 18,5kW (A6:6)	1465	35,6	18,50	77.900	77	225	2
26028663__A	HBA 112 T4 22kW (A6:3)	1470	40,1	22	89.800	74	221	2
26028666__A	HBA 112 T4 22kW (A6:6)	1470	40,1	22	88.400	75	226	2
26029666__A	HBA 112 T4 30kW (A6:6)	1475	56,3	30	104.000	76	272	2
27006674__A	HBA 125 T4 11kW (A7:4)	1460	21,2	11	71.400	83	182	2
27007674__A	HBA 125 T4 15kW (A7:4)	1460	29,8	15	85.800	80	205	2
27007678__A	HBA 125 T4 15kW (A7:8)	1460	29,8	15	66.300	89	210	2
27008674__A	HBA 125 T4 18,5kW (A7:4)	1465	35,6	18,50	99.200	76	250	2
27008678__A	HBA 125 T4 18,5kW (A7:8)	1465	35,6	18,50	73.800	87	253	2
27009674__A	HBA 125 T4 22kW (A7:4)	1470	40,1	22	105.000	75	247	2
27009678__A	HBA 125 T4 22kW (A7:8)	1470	40,1	22	81.800	86	254	2
27010674__A	HBA 125 T4 30kW (A7:4)	1475	56,3	30	117.000	75	298	2
27010678__A	HBA 125 T4 30kW (A7:8)	1475	56,3	30	99.200	84	305	2
27011674__A	HBA 125 T4 37kW (A7:4)	1475	69,2	37	127.000	76	383	2
27012678__A	HBA 125 T4 37kW (A7:8)	1475	69,2	37	114.000	80	430	2
27012678__A	HBA 125 T4 45kW (A7:8)	1475	80,7	45	129.000	79	430	2

## Silnik trójfazowy / 6-biegunowy

Kod	Model	R.P.M.	Natężenie I (400V) A	Moc nominalna kW	Maks. Przepływ m3/h	Hałas db (A)*	Masa	Schemat połączenia
-----	-------	--------	----------------------	------------------	---------------------	---------------	------	--------------------

Kod	Model	R.P.M.	Natężenie I (400V) A	Moc nominalna kW	Maks. Przepływ m <sup>3</sup> /h	Hałas db (A)*	Masa	Schemat połączenia
26044606__A	HBA 40 T6 0,12kW (A0:6)	850	0,62	0,12	2.760	36	15	2
26049606__A	HBA 45 T6 0,13kW (A0:6)	920	0,41	0,13	4.710	41	17	2
26052606__A	HBA 50 T6 0,13kW (A0:6)	920	0,41	0,13	6.040	43	19	2
26056656__A	HBA 56 T6 0,25kW (A5:6)	900	0,92	0,25	7.700	47	41	2
26057656__A	HBA 56 T6 0,37kW (A5:6)	900	1,27	0,37	8.770	47	41	2
26054626__A	HBA 56 T6 0,55kW (A2:6)	900	1,8	0,55	9.000	45	41	2
26054629__A	HBA 56 T6 0,55kW (A2:9)	900	1,8	0,55	9.510	47	45	2
26063656__A	HBA 63 T6 0,37kW (A5:6)	900	1,27	0,37	10.760	49	43	2
26064626__A	HBA 63 T6 0,55kW (A2:6)	900	1,8	0,55	13.000	45	45	2
26064629__A	HBA 63 T6 0,55kW (A2:9)	900	1,8	0,55	11.900	49	48	2
26064656__A	HBA 63 T6 0,55kW (A5:6)	900	1,8	0,55	12.050	49	44	2
26065629__A	HBA 63 T6 0,75kW (A2:9)	910	1,95	0,75	14.100	50	49	2
26071626__A	HBA 71 T6 0,55kW (A2:6)	900	1,8	0,55	15.500	49	46	2
26071629__A	HBA 71 T6 0,55kW (A2:9)	900	1,8	0,55	12.700	53	48	2
26072626__A	HBA 71 T6 0,75kW (A2:6)	910	1,95	0,75	18.100	51	46	2
26072629__A	HBA 71 T6 0,75kW (A2:9)	910	1,95	0,75	16.400	53	48	2
26072656__A	HBA 71 T6 0,75kW (A5:6)	910	1,95	0,75	16.250	53	47	2
26073629__A	HBA 71 T6 1,1kW (A2:9)	910	2,78	1,10	19.600	52	51	2
26080626__A	HBA 80 T6 0,75kW (A2:6)	910	1,95	0,75	19.500	53	57	2
26080629__A	HBA 80 T6 0,75kW (A2:9)	910	1,95	0,75	17.100	58	59	2
26080656__A	HBA 80 T6 0,75kW (A5:6)	910	1,95	0,75	18.300	59	57	2
26081626__A	HBA 80 T6 1,1kW (A2:6)	910	2,78	1,10	23.400	52	59	2
26081629__A	HBA 80 T6 1,1kW (A2:9)	910	2,78	1,10	20.700	56	62	2
26081656__A	HBA 80 T6 1,1kW (A5:6)	910	2,78	1,10	20.550	55	59	2
26082626__A	HBA 80 T6 1,5kW (A2:6)	940	3,71	1,50	25.300	53	61	2
26082629__A	HBA 80 T6 1,5kW (A2:9)	940	3,71	1,50	24.800	55	63	2
26082656__A	HBA 80 T6 1,5kW (A5:6)	940	3,71	1,50	22.970	55	60	2
26083629__A	HBA 80 T6 2,2kW (A2:9)	940	5,94	2,20	27.100	55	64	2
26083656__A	HBA 80 T6 2,2kW (A5:6)	940	5,94	2,20	25.190	56	62	2
26091663__A	HBA 90 T6 1,5kW (A6:3)	940	3,71	1,50	26.800	52	65	2
26091666__A	HBA 90 T6 1,5kW (A6:6)	940	3,71	1,50	23.500	62	68	2
26092663__A	HBA 90 T6 2,2kW (A6:3)	940	5,94	2,20	31.100	59	70	2
26092666__A	HBA 90 T6 2,2kW (A6:6)	940	5,94	2,20	28.100	63	73	2
26093663__A	HBA 90 T6 3kW (A6:3)	960	7,3	3	32.200	61	87	2
26093666__A	HBA 90 T6 3kW (A6:6)	960	7,3	3	33.400	60	91	2
26094666__A	HBA 90 T6 4kW (A6:6)	960	9,46	4	36.600	60	97	2
26010663__A	HBA 100 T6 1,5kW (A6:3)	940	3,71	1,50	31.500	59	78	2
26011663__A	HBA 100 T6 2,2kW (A6:3)	940	5,94	2,20	37.900	58	80	2
26011666__A	HBA 100 T6 2,2kW (A6:6)	940	5,94	2,20	31.300	66	86	2

Kod	Model	R.P.M.	Natężenie I (400V) A	Moc nominalna kW	Maks. Przepływ m <sup>3</sup> /h	Hałas db (A)*	Masa	Schemat połączenia
26012663__A	HBA 100 T6 3kW (A6:3)	960	7,3	3	40.800	60	97	2
26012666__A	HBA 100 T6 3kW (A6:6)	960	7,3	3	36.400	66	104	2
26013663__A	HBA 100 T6 4kW (A6:3)	960	9,46	4	43.500	62	107	2
26013666__A	HBA 100 T6 4kW (A6:6)	960	9,46	4	41.100	65	110	2
26014666__A	HBA 100 T6 5,5kW (A6:6)	960	12,8	5,50	48.700	63	114	2
26015666__A	HBA 100 T6 7,5kW (A6:6)	965	15,2	7,50	50.700	65	140	2
26020663__A	HBA 112 T6 2,2kW (A6:3)	940	5,94	2,20	41.000	63	99	2
26020666__A	HBA 112 T6 2,2kW (A6:6)	940	5,94	2,20	32.500	69	100	2
26021663__A	HBA 112 T6 3kW (A6:3)	960	7,3	3	49.400	64	115	2
26021666__A	HBA 112 T6 3kW (A6:6)	960	7,3	3	39.800	68	118	2
26022663__A	HBA 112 T6 4kW (A6:3)	960	9,46	4	54.200	64	121	2
26022666__A	HBA 112 T6 4kW (A6:6)	960	9,46	4	47.100	68	128	2
26023663__A	HBA 112 T6 5,5kW (A6:3)	960	12,8	5,50	58.200	64	124	2
26023666__A	HBA 112 T6 5,5kW (A6:6)	960	12,8	5,50	53.900	66	131	2
26024666__A	HBA 112 T6 7,5kW (A6:6)	965	15,2	7,50	64.100	66	183	2
26025666__A	HBA 112 T6 11kW (A6:6)	970	22,6	11	67.300	68	198	2
27002674__A	HBA 125 T6 3kW (A7:4)	960	7,3	3	46.300	73	130	2
27003674__A	HBA 125 T6 4kW (A7:4)	960	9,46	4	55.600	70	140	2
27004674__A	HBA 125 T6 5,5kW (A7:4)	960	12,8	5,50	64.300	66	145	2
27004678__A	HBA 125 T6 5,5kW (A7:8)	960	12,8	5,50	47.800	78	149	2
27005674__A	HBA 125 T6 7,5kW (A7:4)	965	15,2	7,50	75.700	65	198	2
27005678__A	HBA 125 T6 7,5kW (A7:8)	965	15,2	7,50	58.600	75	207	2
27006674__A	HBA 125 T6 11kW (A7:4)	970	22,6	11	82.400	66	215	2
27006678__A	HBA 125 T6 11kW (A7:8)	970	22,6	11	78.900	69	224	2
27007678__A	HBA 125 T6 15kW (A7:8)	970	27,7	15	93.300	68	264	2

## SILNIK 2 BIEGOWY / 4/8-biegowowy

Kod	Model	R.P.M.	Natężenie I (400V) A	Moc nominalna kW	Maks. Przepływ m <sup>3</sup> /h	Hałas db (A)*	Masa	Schemat połączenia
26045606__AV	HBA 45 T4/T8 0,33/0,04kW (A0:6)	1360	1,5/0,5	0.33/0.04	6.610	-	15	3
26050606__AV	HBA 50 T4/T8 0,55/0,09kW (A0:6)	1410	2/0,5	0.55/0.09	9.320	-	21	3
26057656__AV	HBA 56 T4/T8 0,33/0,04kW (A5:6)	1360	1,5/0,5	0.33/0.04	7.230	42	42	3
26058626__AV	HBA 56 T4/T8 0,55/0,09kW (A2:6)	1410	2/0,5	0.55/0.09	8.290	40	42	3
26058629__AV	HBA 56 T4/T8 0,55/0,09kW (A2:9)	1410	2/0,5	0.55/0.09	6.590	40	42	3
26058656__AV	HBA 56 T4/T8 0,55/0,09kW (A5:6)	1410	2/0,5	0.55/0.09	8.680	43	43	3
26059626__AV	HBA 56 T4/T8 0,75/0,12kW (A2:6)	1430	1,8/1	0.75/0.12	10.500	38	48	3
26059629__AV	HBA 56 T4/T8 0,75/0,12kW (A2:9)	1430	1,8/1	0.75/0.12	8.170	40	48	3



Kod	Model	R.P.M.	Natężenie I (400V) A	Moc nominalna kW	Maks. Przepływ m <sup>3</sup> /h	Hałas db (A)*	Masa	Schemat połączenia
26059656__AV	HBA 56 T4/T8 0,75/0,12kW (A5:6)	1430	1,8/1	0.75/0.12	10.810	42	44	3
26060626__AV	HBA 56 T4/T8 1,1/0,18kW (A2:6)	1400	3/0,8	1.1/0.18	12.900	38	45	3
26060629__AV	HBA 56 T4/T8 1,1/0,18kW (A2:9)	1400	3/0,8	1.1/0.18	11.700	41	48	3
26060656__AV	HBA 56 T4/T8 1,1/0,18kW (A5:6)	1400	3/0,8	1.1/0.18	12.520	40	45	3
26061626__AV	HBA 56 T4/T8 1,5/0,25kW (A2:6)	1380	4/1,5	1.5/0.25	13.900	40	48	3
26061629__AV	HBA 56 T4/T8 1,5/0,25kW (A2:9)	1380	4/1,5	1.5/0.25	13.600	41	50	3
26061656__AV	HBA 56 T4/T8 1,5/0,25kW (A5:6)	1380	4/1,5	1.5/0.25	13.560	42	47	3
26064626__AV	HBA 63 T4/T8 0,55/0,09kW (A2:6)	1410	2/0,5	0.55/0.09	9.020	38	47	3
26065626__AV	HBA 63 T4/T8 0,75/0,12kW (A2:6)	1430	1,8/1	0.75/0.12	11.400	41	48	3
26065629__AV	HBA 63 T4/T8 0,75/0,12kW (A2:9)	1430	1,8/1	0.75/0.12	9.120	43	49	3
26065656__AV	HBA 63 T4/T8 0,75/0,12kW (A5:6)	1430	1,8/1	0.75/0.12	12.020	45	45	3
26066626__AV	HBA 63 T4/T8 1,1/0,18kW (A2:6)	1400	3/0,8	1.1/0.18	15.000	41	48	3
26066629__AV	HBA 63 T4/T8 1,1/0,18kW (A2:9)	1400	3/0,8	1.1/0.18	13.500	43	50	3
26066656__AV	HBA 63 T4/T8 1,1/0,18kW (A5:6)	1400	3/0,8	1.1/0.18	14.740	46	49	3
26067626__AV	HBA 63 T4/T8 1,5/0,25kW (A2:6)	1380	4/1,5	1.5/0.25	18.300	40	46	3
26067629__AV	HBA 63 T4/T8 1,5/0,25kW (A2:9)	1380	4/1,5	1.5/0.25	15.700	44	49	3
26067656__AV	HBA 63 T4/T8 1,5/0,25kW (A5:6)	1380	4/1,5	1.5/0.25	16.610	44	51	3
26068626__AV	HBA 63 T4/T8 2,2/0,37kW (A2:6)	1430	4/1,25	2.2/0.37	20.100	41	47	3
26068629__AV	HBA 63 T4/T8 2,2/0,37kW (A2:9)	1430	4/1,25	2.2/0.37	20.300	44	50	3
26068656__AV	HBA 63 T4/T8 2,2/0,37kW (A5:6)	1430	4/1,25	2.2/0.37	18.630	43	52	3
26069629__AV	HBA 63 T4/T8 3/0,55kW (A2:9)	1420	6,6/18	3/0.55	21.800	44	57	3
26072626__AV	HBA 71 T4/T8 0,75/0,12kW (A2:6)	1430	1,8/1	0.75/0.12	12.000	-	50	3
26072656__AV	HBA 71 T4/T8 0,75/0,12kW (A5:6)	1430	1,8/1	0.75/0.12	13.630	50	51	3
26073626__AV	HBA 71 T4/T8 1,1/0,18kW (A2:6)	1400	3/0,8	1.1/0.18	15.500	-	51	3
26073629__AV	HBA 71 T4/T8 1,1/0,18kW (A2:9)	1400	3/0,8	1.1/0.18	12.100	50	54	3
26073656__AV	HBA 71 T4/T8 1,1/0,18kW (A5:6)	1400	3/0,8	1.1/0.18	16.800	49	53	3
26074626__AV	HBA 71 T4/T8 1,5/0,25kW (A2:6)	1380	4/1,5	1.5/0.25	20.800	44	52	3
26074629__AV	HBA 71 T4/T8 1,5/0,25kW (A2:9)	1380	4/1,5	1.5/0.25	15.700	48	53	3
26074656__AV	HBA 71 T4/T8 1,5/0,25kW (A5:6)	1380	4/1,5	1.5/0.25	19.960	48	55	3
26075626__AV	HBA 71 T4/T8 2,2/0,37kW (A2:6)	1430	4/1,25	2.2/0.37	25.300	43	57	3
26075629__AV	HBA 71 T4/T8 2,2/0,37kW (A2:9)	1430	4/1,25	2.2/0.37	21.600	47	58	3
26075656__AV	HBA 71 T4/T8 2,2/0,37kW (A5:6)	1430	4/1,25	2.2/0.37	23.200	46	60	3
26076626__AV	HBA 71 T4/T8 3/0,55kW (A2:6)	1420	6,6/18	3/0.55	27.900	44	59	3
26076629__AV	HBA 71 T4/T8 3/0,55kW (A2:9)	1420	6,6/18	3/0.55	25.300	47	60	3
26076656__AV	HBA 71 T4/T8 3/0,55kW (A5:6)	1420	6,6/18	3/0.55	25.160	48	62	3
26081626__AV	HBA 80 T4/T8 1,1/0,18kW (A2:6)	1400	3/0,8	1.1/0.18	15.400	47	55	3
26082626__AV	HBA 80 T4/T8 1,5/0,25kW (A2:6)	1380	4/1,5	1.5/0.25	20.300	47	56	3
26082629__AV	HBA 80 T4/T8 1,5/0,25kW (A2:9)	1380	4/1,5	1.5/0.25	16.200	55	56	3
26083626__AV	HBA 80 T4/T8 2,2/0,37kW (A2:6)	1430	4/1,25	2.2/0.37	27.900	47	57	3



Kod	Model	R.P.M.	Natężenie I (400V) A	Moc nominalna kW	Maks. Przepływ m <sup>3</sup> /h	Hałas db (A)*	Masa	Schemat połączenia
26083629__AV	HBA 80 T4/T8 2,2/0,37kW (A2:9)	1430	4/1,25	2.2/0.37	21.200	53	58	3
26084626__AV	HBA 80 T4/T8 3/0,55kW (A2:6)	1420	6,6/18	3/0.55	32.500	46	62	3
26084629__AV	HBA 80 T4/T8 3/0,55kW (A2:9)	1420	6,6/18	3/0.55	26.400	51	63	3
26084656__AV	HBA 80 T4/T8 3/0,55kW (A5:6)	1420	6,6/18	3/0.55	31.090	48	67	3
26085626__AV	HBA 80 T4/T8 4/0,75kW (A2:6)	1440	8,5/21,8	4/0.75	36.100	46	78	3
26085629__AV	HBA 80 T4/T8 4/0,75kW (A2:9)	1440	8,5/21,8	4/0.75	29.100	51	78	3
26085656__AV	HBA 80 T4/T8 4/0,75kW (A5:6)	1440	8,5/21,8	4/0.75	34.000	49	78	3
26086626__AV	HBA 80 T4/T8 5,5/1,1kW (A2:6)	1450	11/27,2	5.5/1.1	39.000	46	80	3
26086629__AV	HBA 80 T4/T8 5,5/1,1kW (A2:9)	1450	11/27,2	5.5/1.1	36.700	49	80	3
26093663__AV	HBA 90 T4/T8 3/0,55kW (A6:3)	1420	6,6/18	3/0.55	30.700	-	70	3
26094663__AV	HBA 90 T4/T8 4/0,75kW (A6:3)	1440	8,5/21,8	4/0.75	37.700	48	75	3
26095663__AV	HBA 90 T4/T8 5,5/1,1kW (A6:3)	1450	11/27,2	5.5/1.1	41.400	51	84	3
26095666__AV	HBA 90 T4/T8 5,5/1,1kW (A6:6)	1450	11/27,2	5.5/1.1	33.400	-	85	3
26096663__AV	HBA 90 T4/T8 7,5/1,5kW (A6:3)	1450	15/4	7.5/1.5	45.700	52	101	3
26096666__AV	HBA 90 T4/T8 7,5/1,5kW (A6:6)	1450	15/4	7.5/1.5	40.800	56	106	3
26097663__AV	HBA 90 T4/T8 11/3kW (A6:3)	1460	22/8,5	11/3	49.700	54	146	3
26097666__AV	HBA 90 T4/T8 11/3kW (A6:6)	1460	22/8,5	11/3	48.700	54	149	3
26097666__AV	HBA 90 T4/T8 15/3,5kW (A6:6)	1460	29,5/11,5	15/3.5	56.500	53	156	3
26014663__AV	HBA 100 T4/T8 5,5/1,1kW (A6:3)	1450	11/27,2	5.5/1.1	48.700	-	98	3
26015663__AV	HBA 100 T4/T8 7,5/1,5kW (A6:3)	1450	15/4	7.5/1.5	55.500	52	112	3
26015666__AV	HBA 100 T4/T8 7,5/1,5kW (A6:6)	1450	15/4	7.5/1.5	44.200	-	115	3
26016663__AV	HBA 100 T4/T8 11/3kW (A6:3)	1460	22/8,5	11/3	63.000	53	157	3
26016666__AV	HBA 100 T4/T8 11/3kW (A6:6)	1460	22/8,5	11/3	56.200	60	160	3
26016663__AV	HBA 100 T4/T8 15/3,5kW (A6:3)	1460	29,5/11,5	15/3.5	67.100	55	152	3
26016666__AV	HBA 100 T4/T8 15/3,5kW (A6:6)	1460	29,5/11,5	15/3.5	63.500	59	157	3
26018666__AV	HBA 100 T4/T8 17/4,3kW (A6:6)	1475	33,4/12,7	17/4.3	71.200	57	181	3
26019666__AV	HBA 100 T4/T8 20/5kW (A6:6)	1470	38,6/14,1	20/5	75.200	58	221	3
26023663__AV	HBA 112 T4/T8 5,5/1,1kW (A6:3)	1450	11/27,2	5.5/1.1	52.700	-	115	3
26024663__AV	HBA 112 T4/T8 7,5/1,5kW (A6:3)	1450	15/4	7.5/1.5	63.400	58	125	3
26025663__AV	HBA 112 T4/T8 11/3kW (A6:3)	1460	22/8,5	11/3	72.600	57	149	3
26025666__AV	HBA 112 T4/T8 11/3kW (A6:6)	1460	22/8,5	11/3	55.700	-	154	3
26026663__AV	HBA 112 T4/T8 15/3,5kW (A6:3)	1460	29,5/11,5	15/3.5	83.600	57	163	3
26026666__AV	HBA 112 T4/T8 15/3,5kW (A6:6)	1460	29,5/11,5	15/3.5	72.700	61	168	3
26027663__AV	HBA 112 T4/T8 17/4,3kW (A6:3)	1475	33,4/12,7	17/4.3	87.300	58	183	3
26027666__AV	HBA 112 T4/T8 17/4,3kW (A6:6)	1475	33,4/12,7	17/4.3	77.900	61	188	3
26028663__AV	HBA 112 T4/T8 20/5kW (A6:3)	1470	38,6/14,1	20/5	89.800	58	220	3
26028666__AV	HBA 112 T4/T8 20/5kW (A6:6)	1470	38,6/14,1	20/5	83.100	60	225	3
26029666__AV	HBA 112 T4/T8 28/6,5kW (A6:6)	1480	52/18	28/6.5	98.900	59	226	3
26030666__AV	HBA 112 T4/T8 35/8kW (A6:6)	1470	67,3/21,8	35/8	104.000	62	350	3

Kod	Model	R.P.M.	Natężenie I (400V) A	Moc nominalna kW	Maks. Przepływ m <sup>3</sup> /h	Hałas db (A)*	Masa	Schemat połączenia
27006674__AV	HBA 125 T4/T8 11/3kW (A7:4)	1460	22/8,5	11/3	71.400	67	187	3
27006674__AV	HBA 125 T4/T8 15/3,5kW (A7:4)	1460	29,5/11,5	15/3.5	85.800	64	205	3
27006678__AV	HBA 125 T4/T8 15/3,5kW (A7:8)	1460	29,5/11,5	15/3.5	66.300	-	210	3
27008674__AV	HBA 125 T4/T8 17/4,3kW (A7:4)	1475	33,4/12,7	17/4.3	93.200	62	205	3
27009674__AV	HBA 125 T4/T8 20/5kW (A7:4)	1470	38,6/14,1	20/5	99.200	60	246	3
27009678__AV	HBA 125 T4/T8 20/5kW (A7:8)	1470	38,6/14,1	20/5	73.800	71	253	3
27010674__AV	HBA 125 T4/T8 28/6,5kW (A7:4)	1480	52/18	28/6.5	117.000	59	247	3
27010678__AV	HBA 125 T4/T8 28/6,5kW (A7:8)	1480	52/18	28/6.5	90.500	69	254	3
27011674__AV	HBA 125 T4/T8 35/8kW (A7:4)	1470	67,3/21,8	35/8	127.000	60	383	3
27011678__AV	HBA 125 T4/T8 35/8kW (A7:8)	1470	67,3/21,8	35/8	107.000	66	388	3
27011678__AV	HBA 125 T4/T8 37/9,2kW (A7:8)	1485	74,2/25,4	37/9.2	114.000	64	391	3
27012678__AV	HBA 125 T4/T8 44/11kW (A7:8)	1480	80,2/27,2	44/11	122.000	63	430	3

**Uwagi:**

\* Całkowity poziom ciśnienia akustycznego w punkcie maksymalnego natężenia przepływu mierzony w dB (A) w wolnym polu w odległości 6 m od źródła

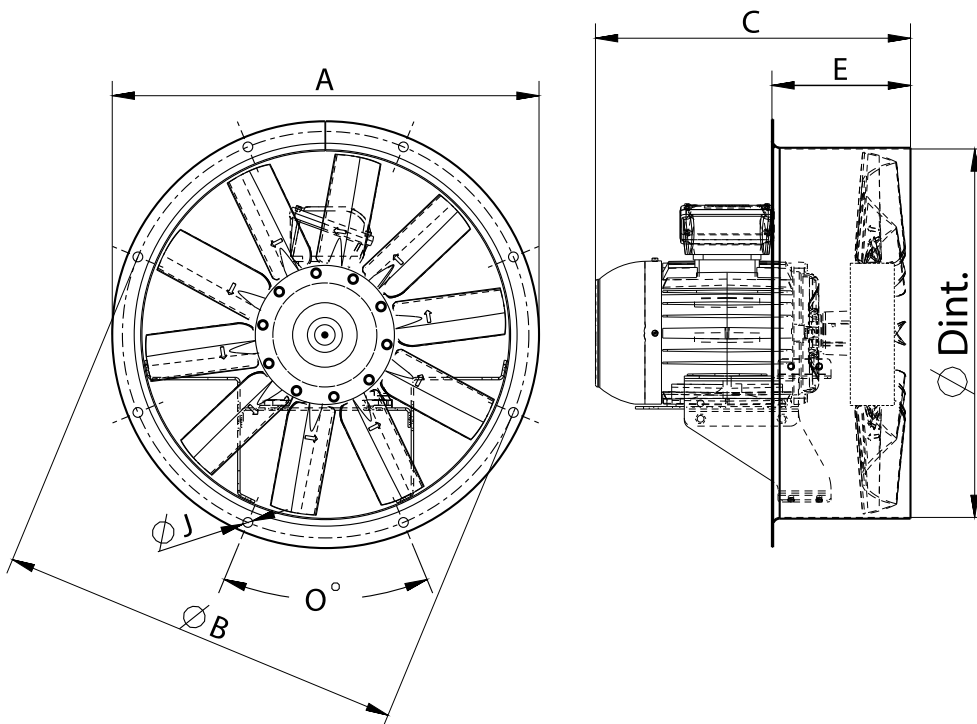
**Wymiary**

Model	C	E	O	ØA	ØB	ØDint	ØJ
HBA 35 M2 0,55kW (A0:6)	306	150	8x45°	434	395	365	10
HBA 35 M2 1,1kW (A0:6)	335	150	8x45°	434	395	365	10
HBA 35 M4 0,12kW (A0:6)	303	150	8x45°	434	395	365	10
HBA 35 T2 0,55kW (A0:6)	306	150	8x45°	434	395	365	10
HBA 35 T2 1,1kW (A0:6)	335	150	8x45°	434	395	365	10
HBA 35 T4 0,12kW (A0:6)	303	150	8x45°	434	395	365	10
HBA 40 M4 0,25kW (A0:6)	301	150	8x45°	472	450	403	10
HBA 40 M6 0,04kW (A0:6)	303	150	8x45°	472	450	403	10
HBA 40 T2 1,1kW (A0:6)	335	150	8x45°	472	450	403	10
HBA 40 T4 0,25kW (A0:6)	301	150	8x45°	472	450	403	10
HBA 40 T6 0,12kW (A0:6)	303	150	8x45°	472	450	403	10
HBA 45 M4 0,37kW (A0:6)	328	165	8x45°	525	500	452	12
HBA 45 M6 0,13kW (A0:6)	347	165	8x45°	525	500	452	12
HBA 45 T2 1,5kW (A0:6)	387	165	8x45°	525	500	452	12
HBA 45 T2 2,2kW (A0:6)	387	165	8x45°	525	500	452	12
HBA 45 T4 0,55kW (A0:6)	347	165	8x45°	525	500	452	12
HBA 45 T6 0,13kW (A0:6)	347	165	8x45°	525	500	452	12
HBA 45 T4/T8 0,33/0,04kW (A0:6)	328	165	8x45°	525	500	452	12
HBA 50 M4 0,55kW (A0:6)	352	165	12x30°	600	560	504	12

Model	C	E	O	ØA	ØB	ØDint	ØJ
HBA 50 M6 0,13kW (A0:6)	352	165	12x30°	600	560	504	12
HBA 50 T4 0,55kW (A0:6)	352	165	12x30°	600	560	504	12
HBA 50 T6 0,13kW (A0:6)	352	165	12x30°	600	560	504	12
HBA 50 T4/T8 0,55/0,09kW (A0:6)	352	165	12x30°	600	560	504	12
HBA 56 M4 0,37kW (A5:6)	338	175	12x30°	646	620	559	12
HBA 56 M4 0,55kW (A2:6)	352	175	12x30°	646	620	559	12
HBA 56 M4 0,55kW (A5:6)	352	175	12x30°	646	620	559	12
HBA 56 M6 0,25kW (A2:6)	338	175	12x30°	646	620	559	12
HBA 56 M6 0,25kW (A5:6)	338	175	12x30°	646	620	559	12
HBA 56 M6 0,37kW (A2:6)	352	175	12X30°	646	620	559	12
HBA 56 M6 0,37kW (A5:6)	352	175	12x30°	646	620	559	12
HBA 56 T4 0,37kW (A5:6)	338	175	12x30°	646	620	559	12
HBA 56 T4 0,55kW (A2:6)	352	175	12x30°	646	620	559	12
HBA 56 T4 0,55kW (A2:9)	352	175	12x30°	646	620	559	12
HBA 56 T4 0,55kW (A5:6)	352	175	12x30°	646	620	559	12
HBA 56 T4 0,75kW (A2:6)	352	175	12x30°	646	620	559	12
HBA 56 T4 0,75kW (A2:9)	352	175	12x30°	646	620	559	12
HBA 56 T4 0,75kW (A5:6)	352	175	12x30°	646	620	559	12
HBA 56 T4 1,1kW (A2:6)	362	175	12x30°	646	620	559	12
HBA 56 T4 1,1kW (A2:9)	362	175	12x30°	646	620	559	12
HBA 56 T4 1,1kW (A5:6)	362	175	12x30°	646	620	559	12
HBA 56 T4 1,5kW (A2:6)	387	175	12X30°	646	620	559	12
HBA 56 T4 1,5kW (A2:9)	387	175	12x30°	646	620	559	12
HBA 56 T4 1,5kW (A5:6)	387	175	12x30°	646	620	559	12
HBA 56 T6 0,25kW (A5:6)	338	175	12x30°	646	620	559	12
HBA 56 T6 0,37kW (A5:6)	352	175	12x30°	646	620	559	12
HBA 56 T6 0,55kW (A2:6)	352	175	12X30°	646	620	559	12
HBA 56 T6 0,55kW (A2:9)	352	175	12X30°	646	620	559	12
HBA 56 T4/T8 0,33/0,04kW (A5:6)	338	175	12x30°	646	620	559	12
HBA 56 T4/T8 0,55/0,09kW (A2:6)	352	175	12X30°	646	620	559	12
HBA 56 T4/T8 0,55/0,09kW (A2:9)	352	175	12X30°	646	620	559	12
HBA 56 T4/T8 0,55/0,09kW (A5:6)	352	175	12x30°	646	620	559	12
HBA 56 T4/T8 0,75/0,12kW (A2:6)	352	175	12X30°	646	620	559	12
HBA 56 T4/T8 0,75/0,12kW (A2:9)	352	175	12X30°	646	620	559	12
HBA 56 T4/T8 0,75/0,12kW (A5:6)	352	175	12x30°	646	620	559	12
HBA 56 T4/T8 1,1/0,18kW (A2:6)	362	175	12x30°	646	620	559	12
HBA 56 T4/T8 1,1/0,18kW (A2:9)	362	175	12x30°	646	620	559	12
HBA 56 T4/T8 1,1/0,18kW (A5:6)	362	175	12x30°	646	620	559	12

Model	C	E	O	ØA	ØB	ØDint	ØJ
HBA 56 T4/T8 1,5/0,25kW (A2:6)	387	175	12X30°	646	620	559	12
HBA 56 T4/T8 1,5/0,25kW (A2:9)	387	175	12x30°	646	620	559	12
HBA 56 T4/T8 1,5/0,25kW (A5:6)	387	175	12x30°	646	620	559	12
HBA 63 M6 0,37kW (A5:6)	352	185	12x30°	725	690	633	12
HBA 63 M6 0,55kW (A2:9)	352	185	12x30°	725	690	633	12
HBA 63 M6 0,55kW (A5:6)	352	185	12x30°	725	690	633	12
HBA 63 T4 0,55kW (A2:6)	352	185	12x30°	725	690	633	12
HBA 63 T4 0,75kW (A2:6)	352	185	12x30°	725	690	633	12
HBA 63 T4 0,75kW (A2:9)	352	185	12x30°	725	690	633	12
HBA 63 T4 0,75kW (A5:6)	352	185	12x30°	725	690	633	12
HBA 63 T4 1,1kW (A2:6)	386	185	12x30°	725	690	633	12
HBA 63 T4 1,1kW (A2:9)	386	185	12x30°	725	690	633	12
HBA 63 T4 1,1kW (A5:6)	386	185	12x30°	725	690	633	12
HBA 63 T4 1,5kW (A2:6)	411	185	12x30°	725	690	633	12
HBA 63 T4 1,5kW (A2:9)	411	185	12x30°	725	690	633	12
HBA 63 T4 1,5kW (A5:6)	411	185	12x30°	725	690	633	12
HBA 63 T4 2,2kW (A2:6)	627	185	12x30°	725	690	633	12
HBA 63 T4 2,2kW (A2:9)	627	185	12x30°	725	690	633	12
HBA 63 T4 2,2kW (A5:6)	627	185	12x30°	725	690	633	12
HBA 63 T4 3kW (A2:9)	627	185	12x30°	725	690	633	12
HBA 63 T6 0,37kW (A5:6)	352	185	12x30°	725	690	633	12
HBA 63 T6 0,55kW (A2:6)	352	185	12x30°	725	690	633	12
HBA 63 T6 0,55kW (A2:9)	352	185	12x30°	725	690	633	12
HBA 63 T6 0,55kW (A5:6)	352	185	12x30°	725	690	633	12
HBA 63 T6 0,75kW (A2:9)	386	185	12x30°	725	690	633	12
HBA 63 T4/T8 0,55/0,09kW (A2:6)	352	185	12X30°	725	690	633	12
HBA 63 T4/T8 0,75/0,12kW (A2:6)	352	185	12X30°	725	690	633	12
HBA 63 T4/T8 0,75/0,12kW (A2:9)	352	185	12X30°	725	690	633	12
HBA 63 T4/T8 0,75/0,12kW (A5:6)	352	185	12x30°	725	690	633	12
HBA 63 T4/T8 1,1/0,18kW (A2:6)	386	185	12X30°	725	690	633	12
HBA 63 T4/T8 1,1/0,18kW (A2:9)	386	185	12X30°	725	690	633	12
HBA 63 T4/T8 1,1/0,18kW (A5:6)	386	185	12x30°	725	690	633	12
HBA 63 T4/T8 1,5/0,25kW (A2:6)	411	185	12X30°	725	690	633	12
HBA 63 T4/T8 1,5/0,25kW (A2:9)	411	185	12X30°	725	690	633	12
HBA 63 T4/T8 1,5/0,25kW (A5:6)	411	185	12x30°	725	690	633	12
HBA 63 T4/T8 2,2/0,37kW (A2:6)	442	185	12X30°	725	690	633	12
HBA 63 T4/T8 2,2/0,37kW (A2:9)	442	185	12X30°	725	690	633	12
HBA 63 T4/T8 2,2/0,37kW (A5:6)	627	185	12x30°	725	690	633	12
HBA 63 T4/T8 3/0,55kW (A2:9)	442	185	12X30°	725	690	633	12
HBA 71 M6 0,55kW (A2:6)	357	190	16x22,5°	802	770	715	12

Model	C	E	O	ØA	ØB	ØDint	ØJ
HBA 71 M6 0,55kW (A2:9)	357	190	16x22,5°	802	770	715	12
HBA 71 T4 0,75KW (A2:6)	357	190	16x22,5°	802	770	715	12
HBA 71 T4 0,75kW (A5:6)	357	190	16x22,5°	802	770	715	12
HBA 71 T4 1,1kW (A2:6)	357	190	16x22,5°	802	770	715	12
HBA 71 T4 1,1kW (A2:9)	391	190	16x22,5°	802	770	715	12
HBA 71 T4 1,1kW (A5:6)	391	190	16x22,5°	802	770	715	12
HBA 71 T4 1,5kW (A2:6)	416	190	16x22,5°	802	770	715	12
HBA 71 T4 1,5kW (A2:9)	416	190	16x22,5°	802	770	715	12
HBA 71 T4 1,5kW (A5:6)	416	190	16x22,5°	802	770	715	12
HBA 71 T4 2,2kW (A2:6)	447	190	16x22,5°	802	770	715	12
HBA 71 T4 2,2kW (A2:9)	447	190	16x22,5°	802	770	715	12
HBA 71 T4 2,2kW (A5:6)	447	190	16x22,5°	802	770	715	12
HBA 71 T4 3kW (A2:6)	447	190	16x22,5°	802	770	715	12
HBA 71 T4 3kW (A2:9)	447	190	16x22,5°	802	770	715	12
HBA 71 T4 3kW (A5:6)	447	190	16x22,5°	802	770	715	12
HBA 71 T6 0,55kW (A2:6)	357	190	16x22,5°	802	770	715	12
HBA 71 T6 0,55kW (A2:9)	357	190	16x22,5°	802	770	715	12
HBA 71 T6 0,75kW (A2:6)	391	190	16x22,5°	802	770	715	12
HBA 71 T6 0,75kW (A2:9)	391	190	16x22,5°	802	770	715	12
HBA 71 T6 0,75kW (A5:6)	391	190	16x22,5°	802	770	715	12
HBA 71 T6 1,1kW (A2:9)	416	190	16x22,5°	802	770	715	12
HBA 71 T4/T8 0,75/0,12kW (A2:6)	357	190	16x22,5°	802	770	715	12
HBA 71 T4/T8 0,75/0,12kW (A5:6)	357	190	16x22,5°	802	770	715	12
HBA 71 T4/T8 1,1/0,18kW (A2:6)	357	190	16x22,5°	802	770	715	12
HBA 71 T4/T8 1,1/0,18kW (A2:9)	391	190	16x22,5°	802	770	715	12
HBA 71 T4/T8 1,1/0,18kW (A5:6)	391	190	16x22,5°	802	770	715	12
HBA 71 T4/T8 1,5/0,25kW (A2:6)	416	190	16x22,5°	802	770	715	12
HBA 71 T4/T8 1,5/0,25kW (A2:9)	416	190	16x22,5°	802	770	715	12
HBA 71 T4/T8 1,5/0,25kW (A5:6)	416	190	16x22,5°	802	770	715	12
HBA 71 T4/T8 2,2/0,37kW (A2:6)	447	190	16x22,5°	802	770	715	12
HBA 71 T4/T8 2,2/0,37kW (A2:9)	447	190	16x22,5°	802	770	715	12
HBA 71 T4/T8 2,2/0,37kW (A5:6)	447	190	16x22,5°	802	770	715	12
HBA 71 T4/T8 3/0,55kW (A2:6)	447	190	16x22,5°	802	770	715	12
HBA 71 T4/T8 3/0,55kW (A2:9)	447	190	16x22,5°	802	770	715	12
HBA 71 T4/T8 3/0,55kW (A5:6)	447	190	16x22,5°	802	770	715	12
HBA 80 T4 1,1KW (A2:6)	427	220	16x22,5°	892	860	801	12
HBA 80 T4 1,5KW (A2:6)	427	220	16x22,5°	892	860	801	12
HBA 80 T4 1,5KW (A2:9)	427	220	16x22,5°	892	860	801	12
HBA 80 T4 2,2kW (A2:6)	463	220	16x22,5°	892	860	801	12
HBA 80 T4 2,2kW (A2:9)	469	220	16x22,5°	892	860	801	12

Model	C	E	O	ØA	ØB	ØDint	ØJ
HBA 80 T4 3kW (A2:6)	463	220	16x22,5°	892	860	801	12
HBA 80 T4 3kW (A2:9)	525	220	16x22,5°	892	860	801	12
HBA 80 T4 3kW (A5:6)	463	220	16x22,5°	892	860	801	12
HBA 80 T4 4kW (A2:6)	469	220	16x22,5°	892	860	801	12
HBA 80 T4 4kW (A2:9)	469	220	16x22,5°	892	860	801	12
HBA 80 T4 4kW (A5:6)	469	220	16x22,5°	892	860	801	12
HBA 80 T4 5,5kW (A2:6)	525	220	16x22,5°	892	860	801	12
HBA 80 T4 5,5kW (A2:9)	525	220	16x22,5°	892	860	801	12
HBA 80 T6 0,75kW (A2:6)	427	220	16x22,5°	892	860	801	12
HBA 80 T6 0,75kW (A2:9)	427	220	16x22,5°	892	860	801	12
HBA 80 T6 0,75kW (A5:6)	427	220	16x22,5°	892	860	801	12
HBA 80 T6 1,1kW (A2:6)	427	220	16x22,5°	892	860	801	12
HBA 80 T6 1,1kW (A2:9)	427	220	16x22,5°	892	860	801	12
HBA 80 T6 1,1kW (A5:6)	427	220	16x22,5°	892	860	801	12
HBA 80 T6 1,5kW (A2:6)	463	220	16x22,5°	892	860	801	12
HBA 80 T6 1,5kW (A2:9)	463	220	16x22,5°	892	860	801	12
HBA 80 T6 1,5kW (A5:6)	463	220	16x22,5°	892	860	801	12
HBA 80 T6 2,2kW (A2:9)	469	220	16x22,5°	892	860	801	12
HBA 80 T6 2,2kW (A5:6)	469	220	16x22,5°	892	860	801	12
HBA 80 T4/T8 1,1/0,18kW (A2:6)	427	220	16x22,5°	892	860	801	12
HBA 80 T4/T8 1,5/0,25kW (A2:6)	427	220	16x22,5°	892	860	801	12
HBA 80 T4/T8 1,5/0,25kW (A2:9)	427	220	16x22,5°	892	860	801	12
HBA 80 T4/T8 2,2/0,37kW (A2:6)	463	220	16x22,5°	892	860	801	12
HBA 80 T4/T8 2,2/0,37kW (A2:9)	463	220	16x22,5°	892	860	801	12
HBA 80 T4/T8 3/0,55kW (A2:6)	463	220	16x22,5°	892	860	801	12
HBA 80 T4/T8 3/0,55kW (A2:9)	463	220	16x22,5°	892	860	801	12
HBA 80 T4/T8 3/0,55kW (A5:6)	463	220	16x22,5°	892	860	801	12
HBA 80 T4/T8 4/0,75kW (A2:6)	469	220	16x22,5°	892	860	801	12
HBA 80 T4/T8 4/0,75kW (A2:9)	469	220	16x22,5°	892	860	801	12
HBA 80 T4/T8 4/0,75kW (A5:6)	469	220	16x22,5°	892	860	801	12
HBA 80 T4/T8 5,5/1,1kW (A2:6)	525	220	16x22,5°	892	860	801	12
HBA 80 T4/T8 5,5/1,1kW (A2:9)	525	220	16x22,5°	892	860	801	12
HBA 90 T4 3kW (A6:3)	658	340	16x22,5°	1000	970	903,5	12
HBA 90 T4 4kW (A6:3)	658	340	16x22,5°	1000	970	903,5	12
HBA 90 T4 5,5kW (A6:3)	658	340	16x22,5°	1000	970	903,5	12
HBA 90 T4 5,5kW (A6:6)	658	340	16x22,5°	1000	970	903,5	12
HBA 90 T4 7,5kW (A6:3)	658	340	16x22,5°	1000	970	903,5	12
HBA 90 T4 7,5kW (A6:6)	658	340	16x22,5°	1000	970	903,5	12
HBA 90 T4 11kW (A6:3)	721	340	16x22,5°	1000	970	903,5	12
HBA 90 T4 11kW (A6:6)	721	340	16x22,5°	1000	970	903,5	12



Model	C	E	O	ØA	ØB	ØDint	ØJ
HBA 90 T4 15kW (A6:6)	742	340	16X22,5°	1000	970	903,5	12
HBA 90 T6 1,5kW (A6:3)	658	340	16X22,5°	1000	970	903,5	12
HBA 90 T6 1,5kW (A6:6)	658	340	16X22,5°	1000	970	903,5	12
HBA 90 T6 2,2kW (A6:3)	658	340	16X22,5°	1000	970	903,5	12
HBA 90 T6 2,2kW (A6:6)	658	340	16X22,5°	1000	970	903,5	12
HBA 90 T6 3kW (A6:3)	658	340	16X22,5°	1000	970	903,5	12
HBA 90 T6 3kW (A6:6)	658	340	16X22,5°	1000	970	903,5	12
HBA 90 T6 4kW (A6:6)	658	340	16X22,5°	1000	970	903,5	12
HBA 90 T4/T8 3/0,55kW (A6:3)	658	340	16X22,5°	1000	970	903,5	12
HBA 90 T4/T8 4/0,75kW (A6:3)	658	340	16X22,5°	1000	970	903,5	12
HBA 90 T4/T8 5,5/1,1kW (A6:3)	658	340	16X22,5°	1000	970	903,5	12
HBA 90 T4/T8 5,5/1,1kW (A6:6)	658	340	16X22,5°	1000	970	903,5	12
HBA 90 T4/T8 7,5/1,5kW (A6:3)	658	340	16X22,5°	1000	970	903,5	12
HBA 90 T4/T8 7,5/1,5kW (A6:6)	658	340	16X22,5°	1000	970	903,5	12
HBA 90 T4/T8 11/3kW (A6:3)	742	340	16X22,5°	1000	970	903,5	12
HBA 90 T4/T8 11/3kW (A6:6)	742	340	16X22,5°	1000	970	903,5	12
HBA 90 T4/T8 15/3,5kW (A6:6)	721	340	16X22,5°	1000	970	903,5	12
HBA 100 T4 5,5kW (A6:3)	653	340	16x22,5°	1115	1070	1013	12
HBA 100 T4 7,5kW (A6:3)	653	340	16x22,5°	1115	1070	1013	12
HBA 100 T4 7,5kW (A6:6)	653	340	16x22,5°	1115	1070	1013	12
HBA 100 T4 11kW (A6:3)	716	340	16x22,5°	1115	1070	1013	12
HBA 100 T4 11kW (A6:6)	716	340	16x22,5°	1115	1070	1013	12
HBA 100 T4 15kW (A6:3)	738	340	16x22,5°	1115	1070	1013	12
HBA 100 T4 15kW (A6:6)	738	340	16x22,5°	1115	1070	1013	12
HBA 100 T4 18,5kW (A6:6)	776	340	16x22,5°	1115	1070	1013	12
HBA 100 T4 22kW (A6:6)	792	340	16x22,5°	1115	1070	1013	12
HBA 100 T6 1,5kW (A6:3)	653	340	16x22,5°	1115	1070	1013	12
HBA 100 T6 2,2kW (A6:3)	653	340	16x22,5°	1115	1070	1013	12
HBA 100 T6 2,2kW (A6:6)	653	340	16x22,5°	1115	1070	1013	12
HBA 100 T6 3kW (A6:3)	653	340	16x22,5°	1115	1070	1013	12
HBA 100 T6 3kW (A6:6)	653	340	16x22,5°	1115	1070	1013	12
HBA 100 T6 4kW (A6:3)	653	340	16x22,5°	1115	1070	1013	12
HBA 100 T6 4kW (A6:6)	653	340	16x22,5°	1115	1070	1013	12
HBA 100 T6 5,5kW (A6:6)	653	340	16x22,5°	1115	1070	1013	12
HBA 100 T6 7,5kW (A6:6)	716	340	16x22,5°	1115	1070	1013	12
HBA 100 T4/T8 5,5/1,1kW (A6:3)	653	340	16x22,5°	1115	1070	1013	12
HBA 100 T4/T8 7,5/1,5kW (A6:3)	653	340	16x22,5°	1115	1070	1013	12
HBA 100 T4/T8 7,5/1,5kW (A6:6)	653	340	16x22,5°	1115	1070	1013	12
HBA 100 T4/T8 11/3kW (A6:3)	738	340	16x22,5°	1115	1070	1013	12
HBA 100 T4/T8 11/3kW (A6:6)	738	340	16x22,5°	1115	1070	1013	12

Model	C	E	O	ØA	ØB	ØDint	ØJ
HBA 100 T4/T8 15/3,5kW (A6:3)	716	340	16x22,5°	1115	1070	1013	12
HBA 100 T4/T8 15/3,5kW (A6:6)	716	340	16x22,5°	1115	1070	1013	12
HBA 100 T4/T8 17/4,3kW (A6:6)	776	340	16x22,5°	1115	1070	1013	12
HBA 100 T4/T8 20/5kW (A6:6)	792	340	16x22,5°	1115	1070	1013	12
HBA 112 T4 5,5kW (A6:3)	760	340	16x22,5°	1234	1190	1132	12
HBA 112 T4 7,5kW (A6:3)	760	340	16x22,5°	1234	1190	1132	12
HBA 112 T4 11kW (A6:3)	760	340	16x22,5°	1234	1190	1132	12
HBA 112 T4 11kW (A6:6)	760	340	16x22,5°	1234	1190	1132	12
HBA 112 T4 15kW (A6:3)	760	340	16x22,5°	1234	1190	1132	12
HBA 112 T4 15kW (A6:6)	760	340	16x22,5°	1234	1190	1132	12
HBA 112 T4 18,5kW (A6:3)	761	340	16x22,5°	1234	1190	1132	12
HBA 112 T4 18,5kW (A6:6)	761	340	16x22,5°	1234	1190	1132	12
HBA 112 T4 22kW (A6:3)	780	340	16x22,5°	1234	1190	1132	12
HBA 112 T4 22kW (A6:6)	780	340	16x22,5°	1234	1190	1132	12
HBA 112 T4 30kW (A6:6)	864	340	16x22,5°	1234	1190	1132	12
HBA 112 T6 2,2kW (A6:3)	760	340	16x22,5°	1234	1190	1132	12
HBA 112 T6 2,2kW (A6:6)	760	340	16x22,5°	1234	1190	1132	12
HBA 112 T6 3kW (A6:3)	760	340	16x22,5°	1234	1190	1132	12
HBA 112 T6 3kW (A6:6)	760	340	16x22,5°	1234	1190	1132	12
HBA 112 T6 4kW (A6:3)	760	340	16x22,5°	1234	1190	1132	12
HBA 112 T6 4kW (A6:6)	760	340	16x22,5°	1234	1190	1132	12
HBA 112 T6 5,5kW (A6:3)	760	340	16x22,5°	1234	1190	1132	12
HBA 112 T6 5,5kW (A6:6)	760	340	16x22,5°	1234	1190	1132	12
HBA 112 T6 7,5kW (A6:6)	760	340	16x22,5°	1234	1190	1132	12
HBA 112 T6 11kW (A6:6)	760	340	16x22,5°	1234	1190	1132	12
HBA 112 T4/T8 5,5/1,1kW (A6:3)	760	340	16x22,5°	1234	1190	1132	12
HBA 112 T4/T8 7,5/1,5kW (A6:3)	760	340	16x22,5°	1234	1190	1132	12
HBA 112 T4/T8 11/3kW (A6:3)	760	340	16x22,5°	1234	1190	1132	12
HBA 112 T4/T8 11/3kW (A6:6)	760	340	16x22,5°	1234	1190	1132	12
HBA 112 T4/T8 15/3,5kW (A6:3)	760	340	16x22,5°	1234	1190	1132	12
HBA 112 T4/T8 15/3,5kW (A6:6)	760	340	16x22,5°	1234	1190	1132	12
HBA 112 T4/T8 17/4,3kW (A6:3)	761	340	16x22,5°	1234	1190	1132	12
HBA 112 T4/T8 17/4,3kW (A6:6)	761	340	16x22,5°	1234	1190	1132	12
HBA 112 T4/T8 20/5kW (A6:3)	780	340	16x22,5°	1234	1190	1132	12
HBA 112 T4/T8 20/5kW (A6:6)	780	340	16x22,5°	1234	1190	1132	12
HBA 112 T4/T8 28/6,5kW (A6:6)	864	340	16x22,5°	1234	1190	1132	12
HBA 112 T4/T8 35/8kW (A6:6)	864	340	16x22,5°	1234	1190	1132	12
HBA 125 T4 11kW (A7:4)	759	340	20x18°	1365	1320	1263	15
HBA 125 T4 15kW (A7:4)	759	340	20x18°	1365	1320	1263	15
HBA 125 T4 15kW (A7:8)	759	340	20x18°	1365	1320	1263	15

Model	C	E	O	ØA	ØB	ØDint	ØJ
HBA 125 T4 18,5kW (A7:4)	760	340	20x18°	1365	1320	1263	15
HBA 125 T4 18,5kW (A7:8)	760	340	20x18°	1365	1320	1263	15
HBA 125 T4 22kW (A7:4)	779	340	20x18°	1365	1320	1263	15
HBA 125 T4 22kW (A7:8)	779	340	20x18°	1365	1320	1263	15
HBA 125 T4 30kW (A7:4)	863	340	20x18°	1365	1320	1263	15
HBA 125 T4 30kW (A7:8)	863	340	20x18°	1365	1320	1263	15
HBA 125 T4 37kW (A7:4)	948	340	20x18°	1365	1320	1263	15
HBA 125 T4 37kW (A7:8)	948	340	20x18°	1365	1320	1263	15
HBA 125 T4 45kW (A7:8)	948	340	20x18°	1365	1320	1263	15
HBA 125 T6 3kW (A7:4)	759	340	20x18°	1365	1320	1263	15
HBA 125 T6 4kW (A7:4)	759	340	20x18°	1365	1320	1263	15
HBA 125 T6 5,5kW (A7:4)	759	340	20x18°	1365	1320	1263	15
HBA 125 T6 5,5kW (A7:8)	759	340	20x18°	1365	1320	1263	15
HBA 125 T6 7,5kW (A7:4)	759	340	20x18°	1365	1320	1263	15
HBA 125 T6 7,5kW (A7:8)	759	340	20x18°	1365	1320	1263	15
HBA 125 T6 11kW (A7:4)	759	340	20x18°	1365	1320	1263	15
HBA 125 T6 11kW (A7:8)	759	340	20x18°	1365	1320	1263	15
HBA 125 T6 15kW (A7:8)	779	340	20x18°	1365	1320	1263	15
HBA 125 T4/T8 11/3kW (A7:4)	759	340	20x18°	1365	1320	1263	15
HBA 125 T4/T8 15/3,5kW (A7:4)	759	340	20x18°	1365	1320	1263	15
HBA 125 T4/T8 15/3,5kW (A7:8)	759	340	20x18°	1365	1320	1263	15
HBA 125 T4/T8 17/4,3kW (A7:4)	760	340	20x18°	1365	1320	1263	15
HBA 125 T4/T8 20/5kW (A7:4)	779	340	20x18°	1365	1320	1263	15
HBA 125 T4/T8 20/5kW (A7:8)	779	340	20x18°	1365	1320	1263	15
HBA 125 T4/T8 28/6,5kW (A7:4)	863	340	20x18°	1365	1320	1263	15
HBA 125 T4/T8 28/6,5kW (A7:8)	863	340	20x18°	1365	1320	1263	15
HBA 125 T4/T8 35/8kW (A7:4)	863	340	20x18°	1365	1320	1263	15
HBA 125 T4/T8 35/8kW (A7:8)	863	340	20x18°	1365	1320	1263	15
HBA 125 T4/T8 37/9,2kW (A7:8)	948	340	20x18°	1365	1320	1263	15
HBA 125 T4/T8 44/11kW (A7:8)	948	340	20x18°	1365	1320	1263	15

## Schematy połączeń

DIAGRAM N° 1

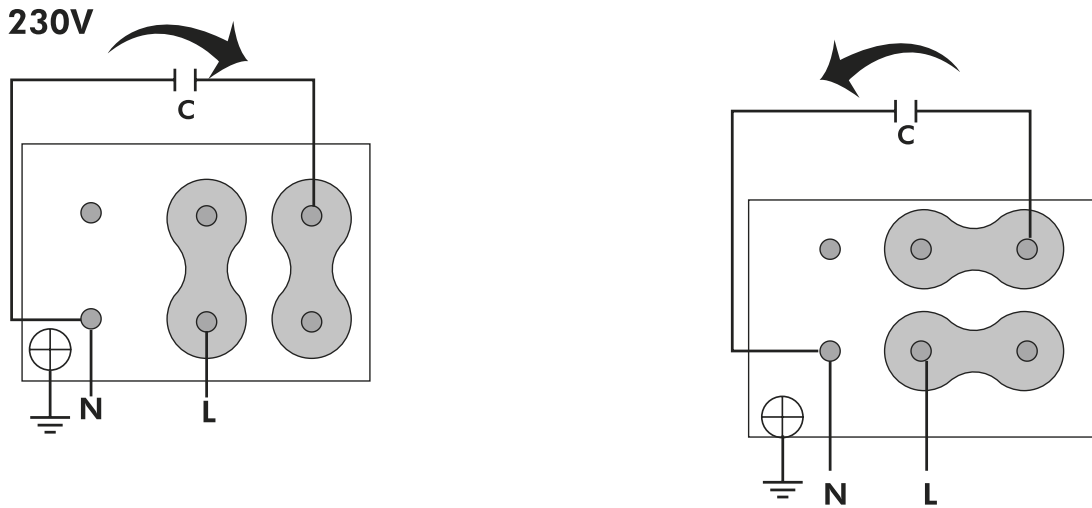

DIAGRAM N° 2

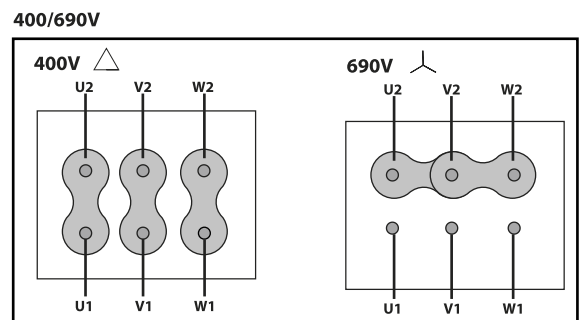
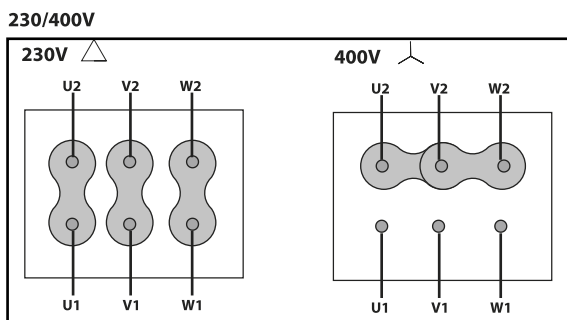
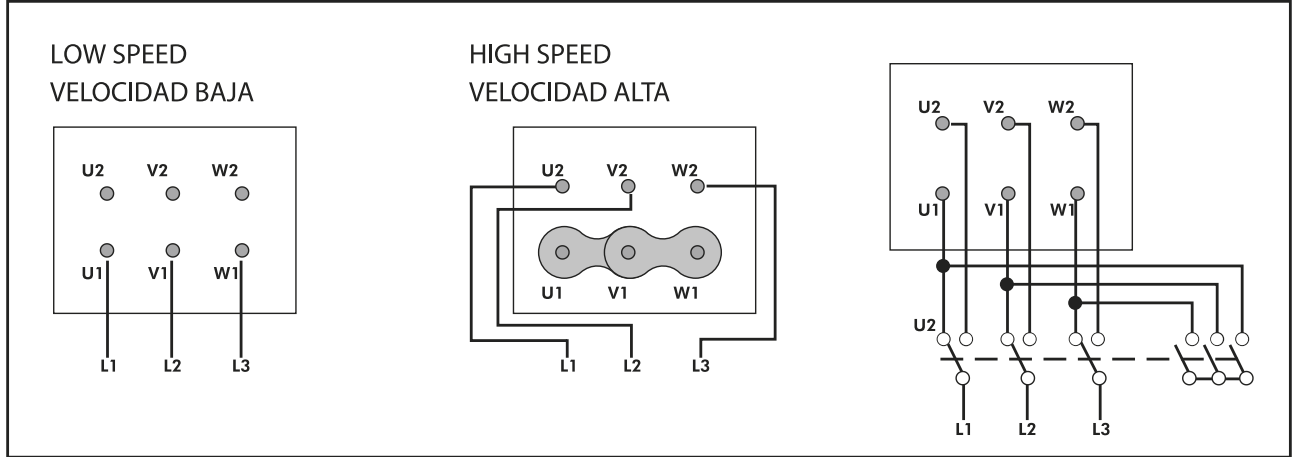

DIAGRAM N° 3

400V DAHLANDER (Y,YY)



# Charakterystyki

HBA 35 M2 0,55kW (A0:6)

HBA 35 M2 1,1kW (A0:6)

## AIR FLOW - PRESSURE

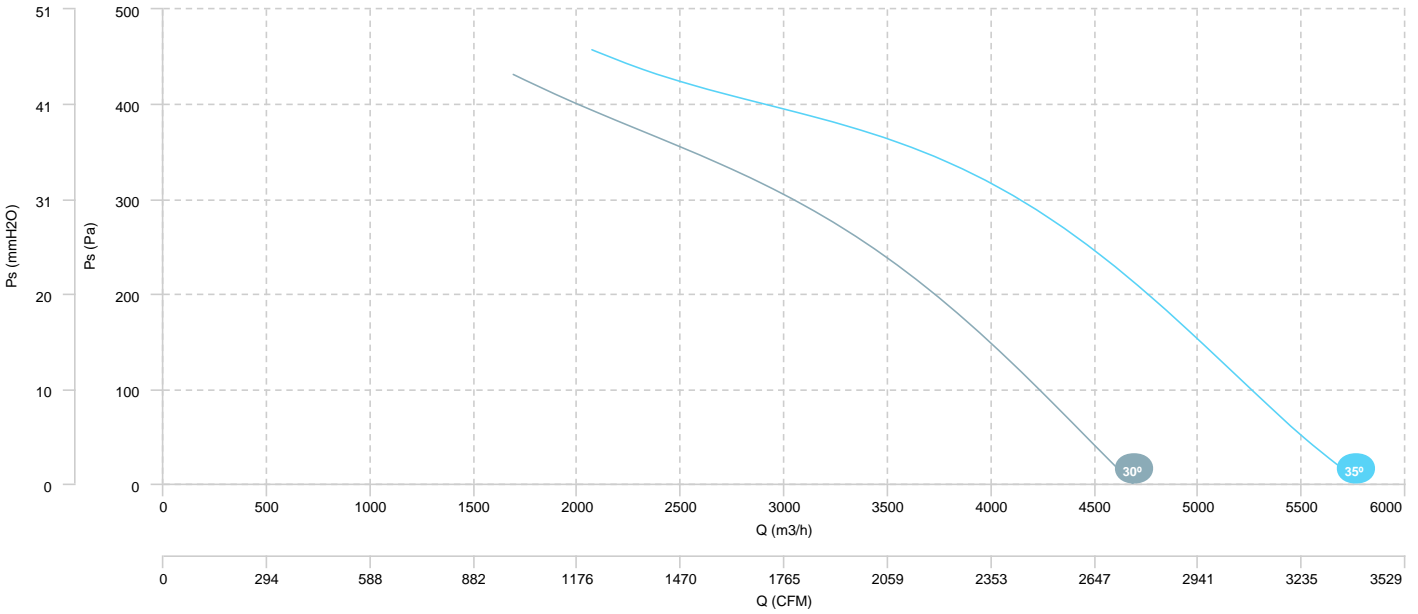

## AIR FLOW - ABSORBED POWER

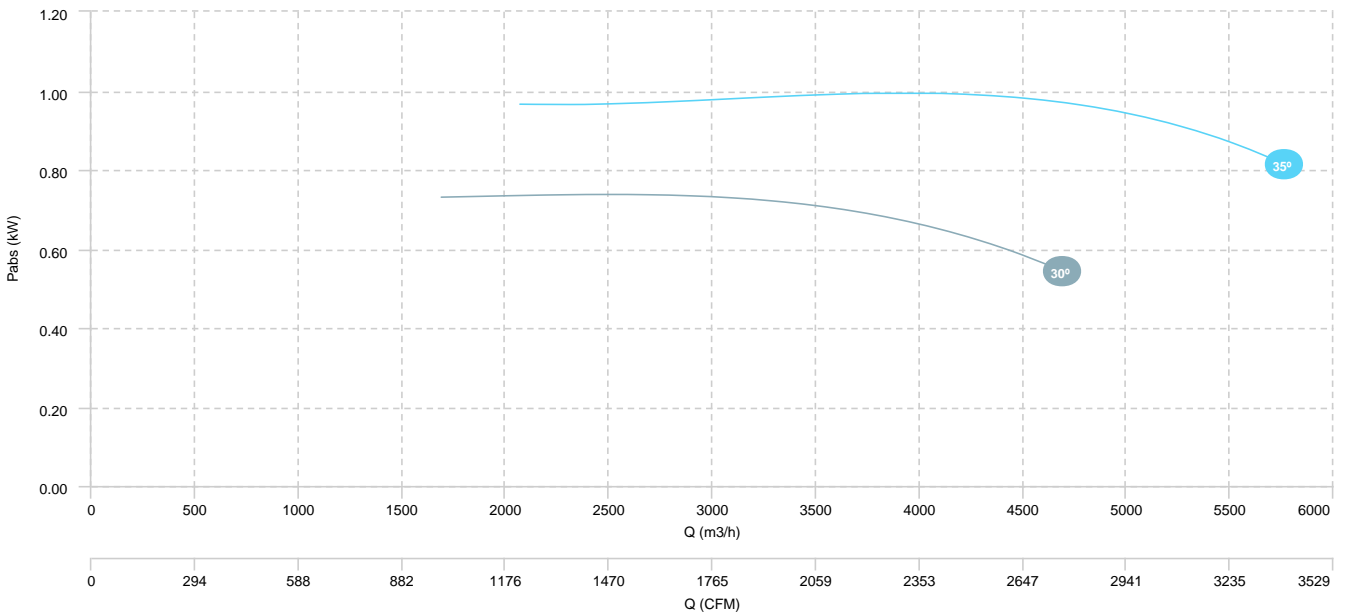

HBA 35 M4 0,12kW (A0:6)

AIR FLOW - PRESSURE

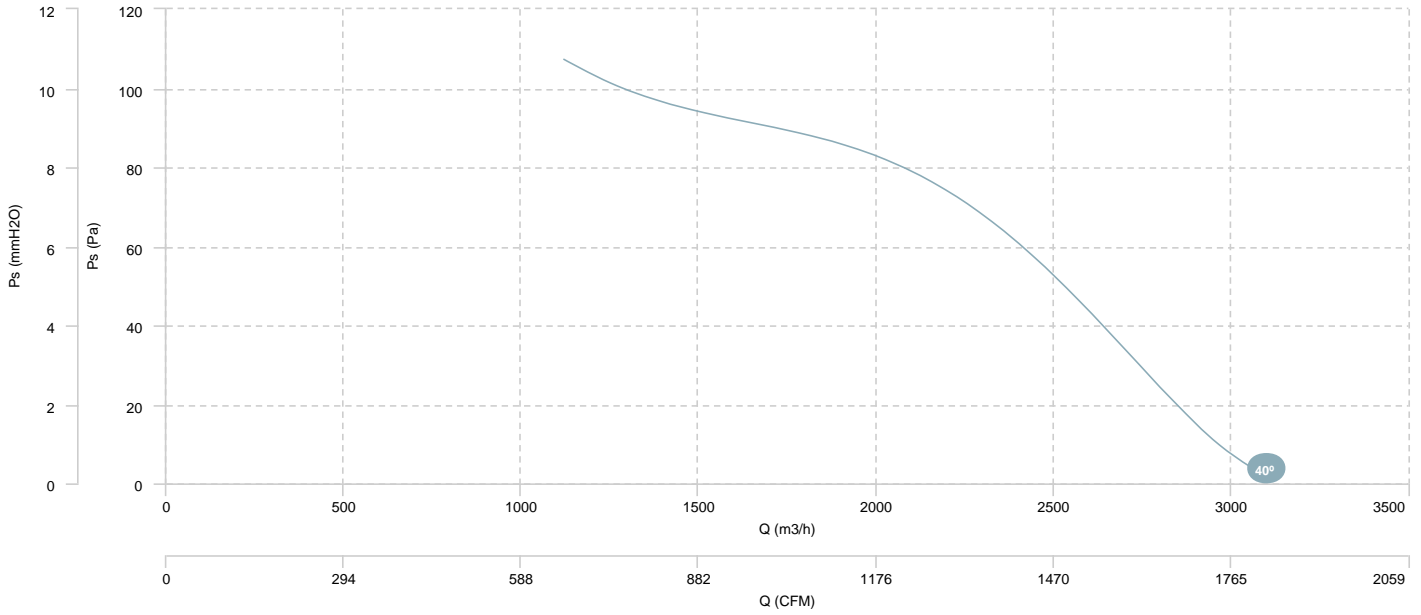

AIR FLOW - ABSORBED POWER

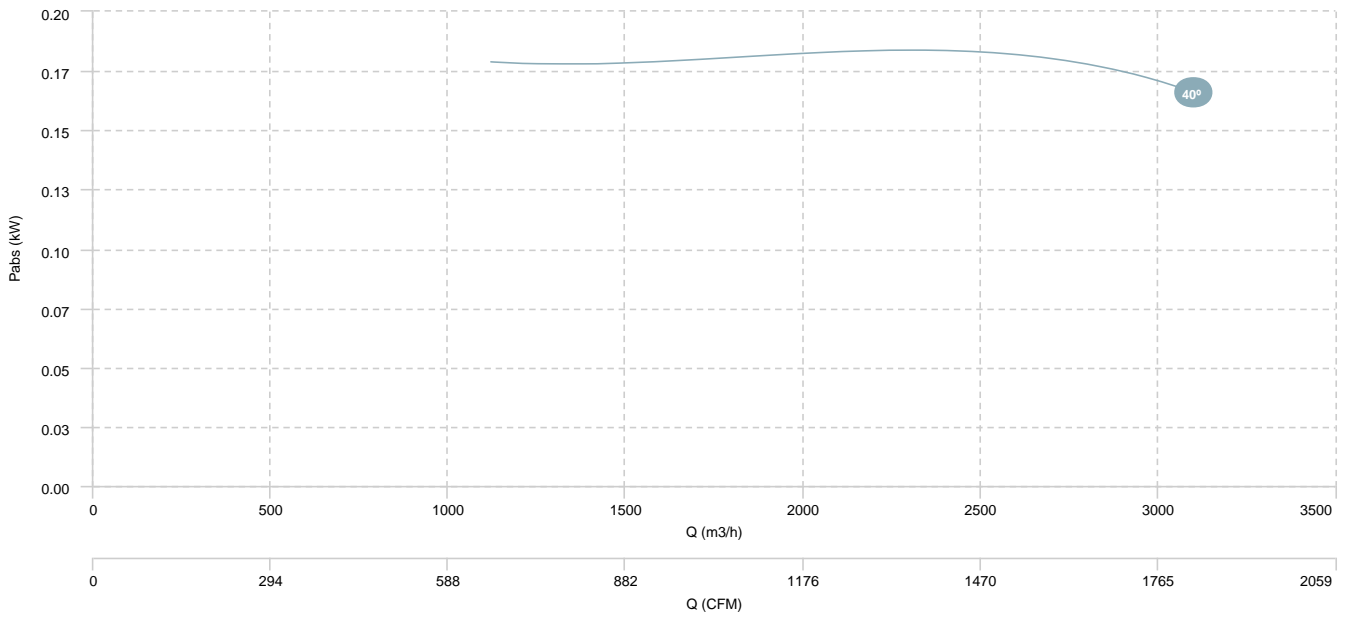



HBA 40 M4 0,25kW (A0:6)

## AIR FLOW - PRESSURE

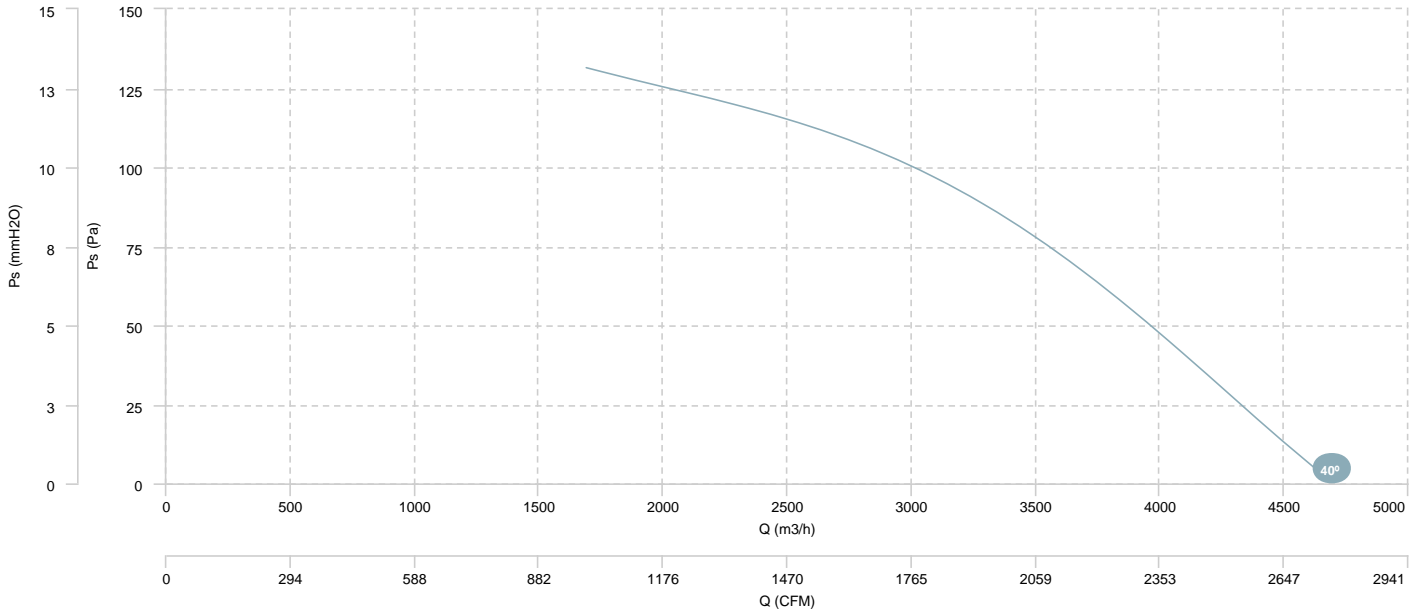

## AIR FLOW - ABSORBED POWER

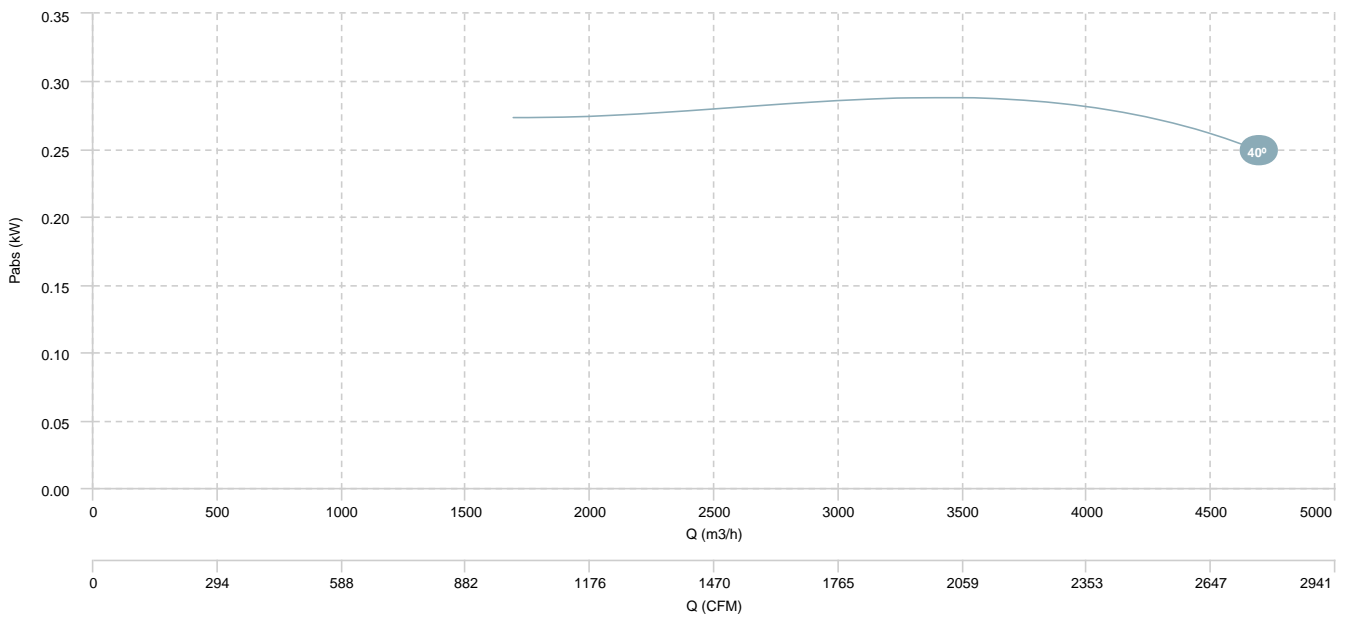

HBA 40 M6 0,04kW (A0:6)

AIR FLOW - PRESSURE

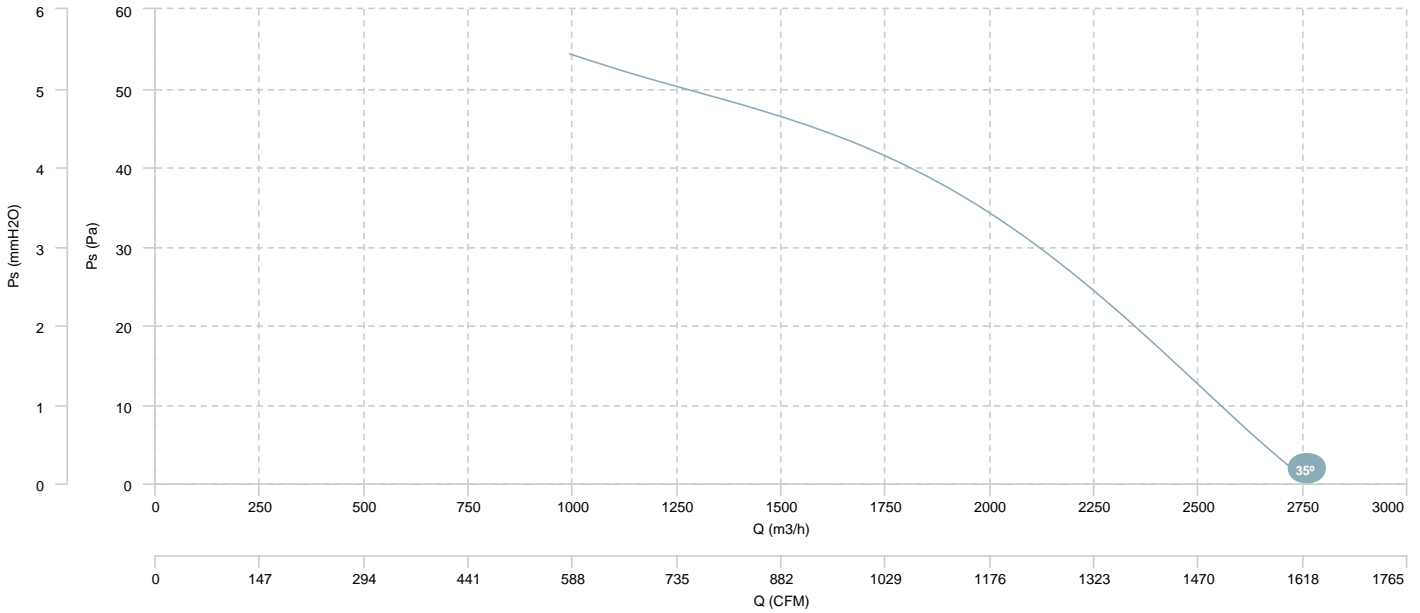

AIR FLOW - ABSORBED POWER

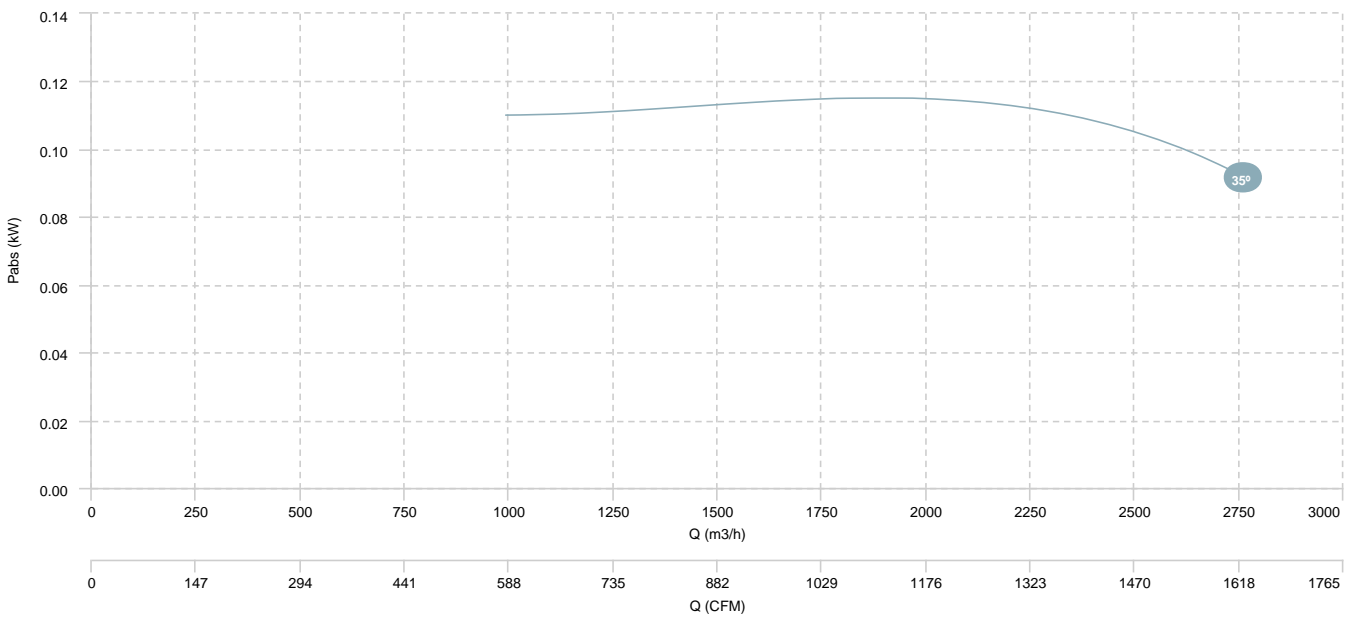

HBA 45 M4 0,37kW (A0:6)

AIR FLOW - PRESSURE

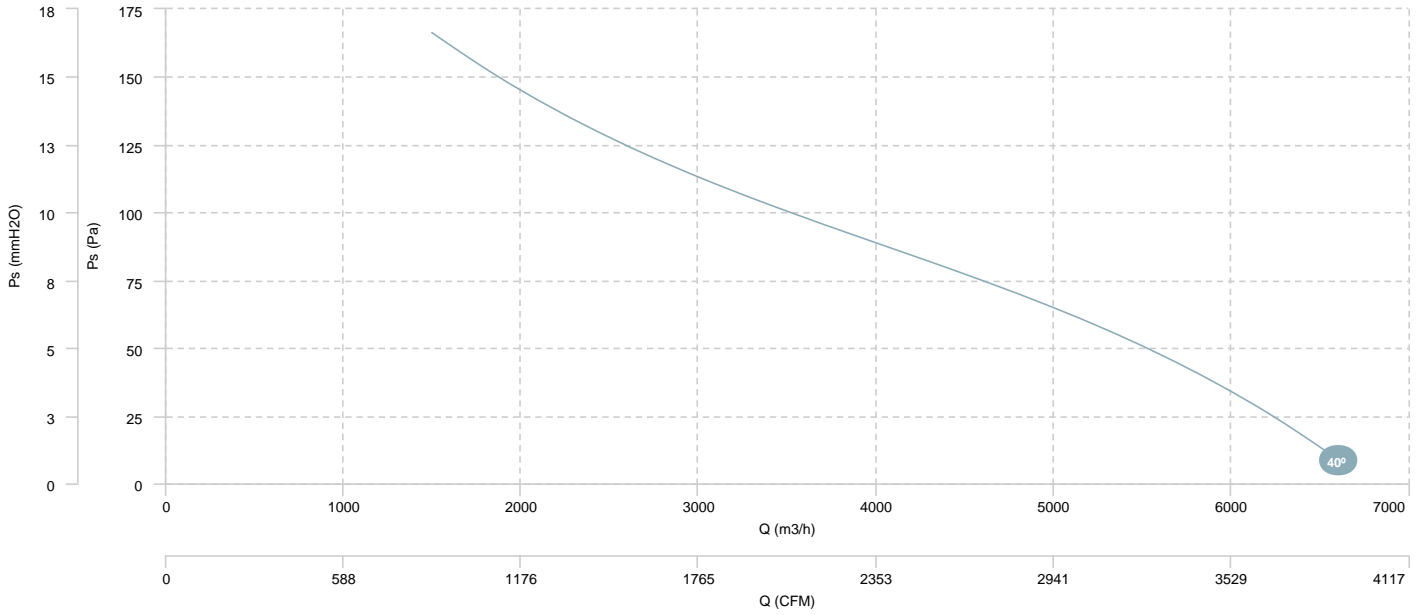

AIR FLOW - ABSORBED POWER

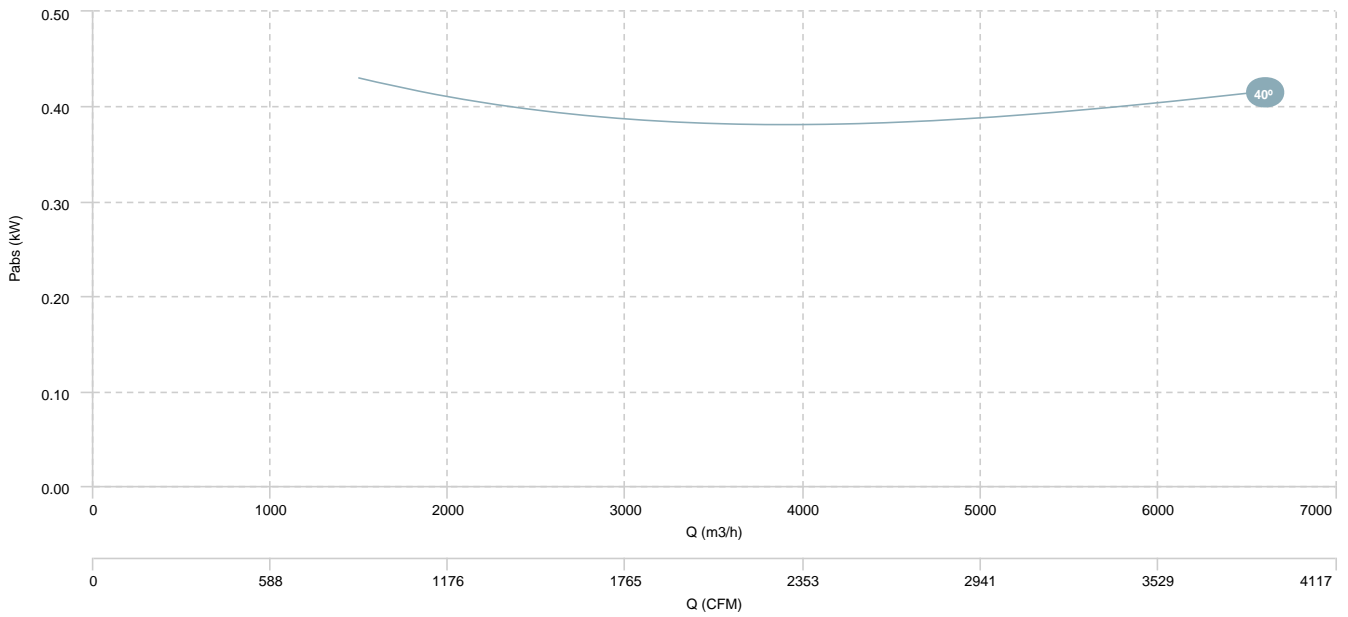

HBA 45 M6 0,13kW (A0:6)

AIR FLOW - PRESSURE

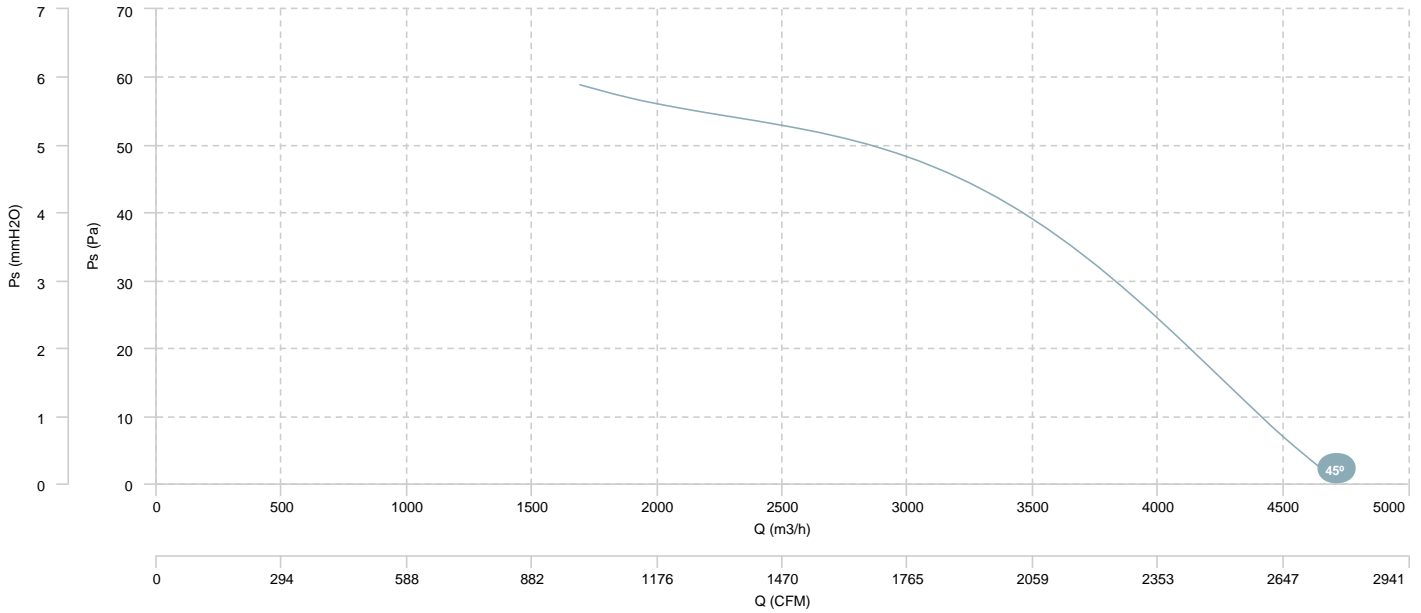

AIR FLOW - ABSORBED POWER

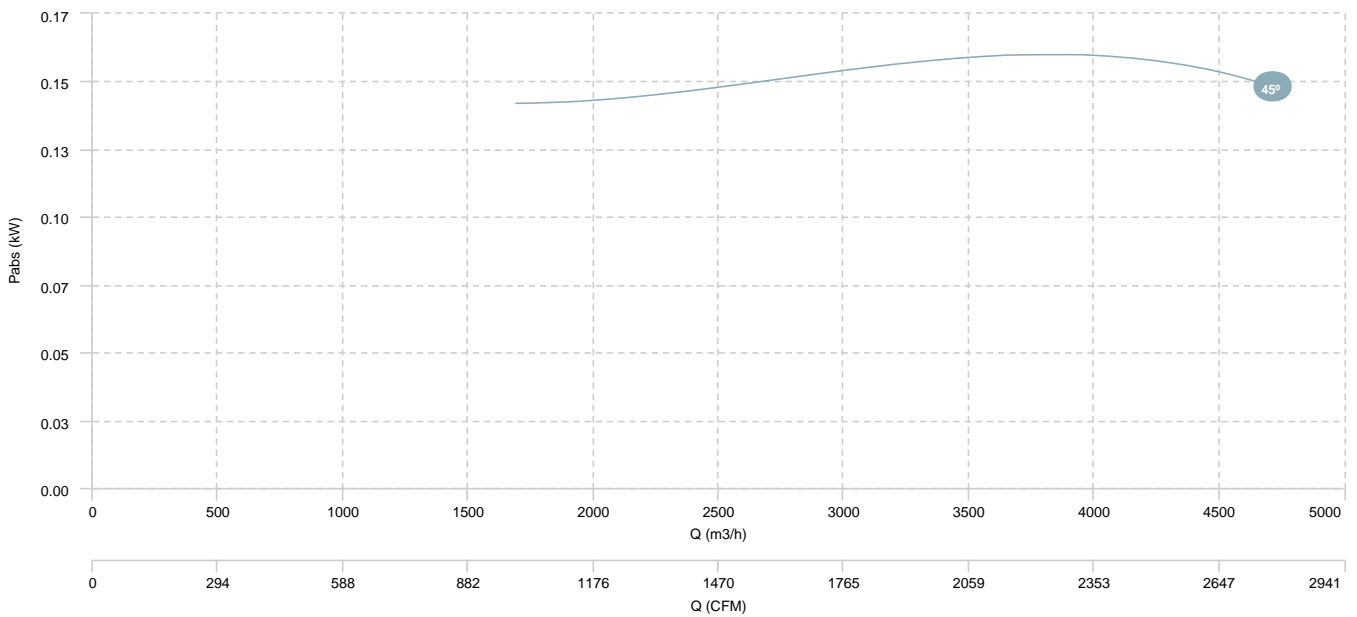

HBA 50 M4 0,55kW (A0:6)

AIR FLOW - PRESSURE

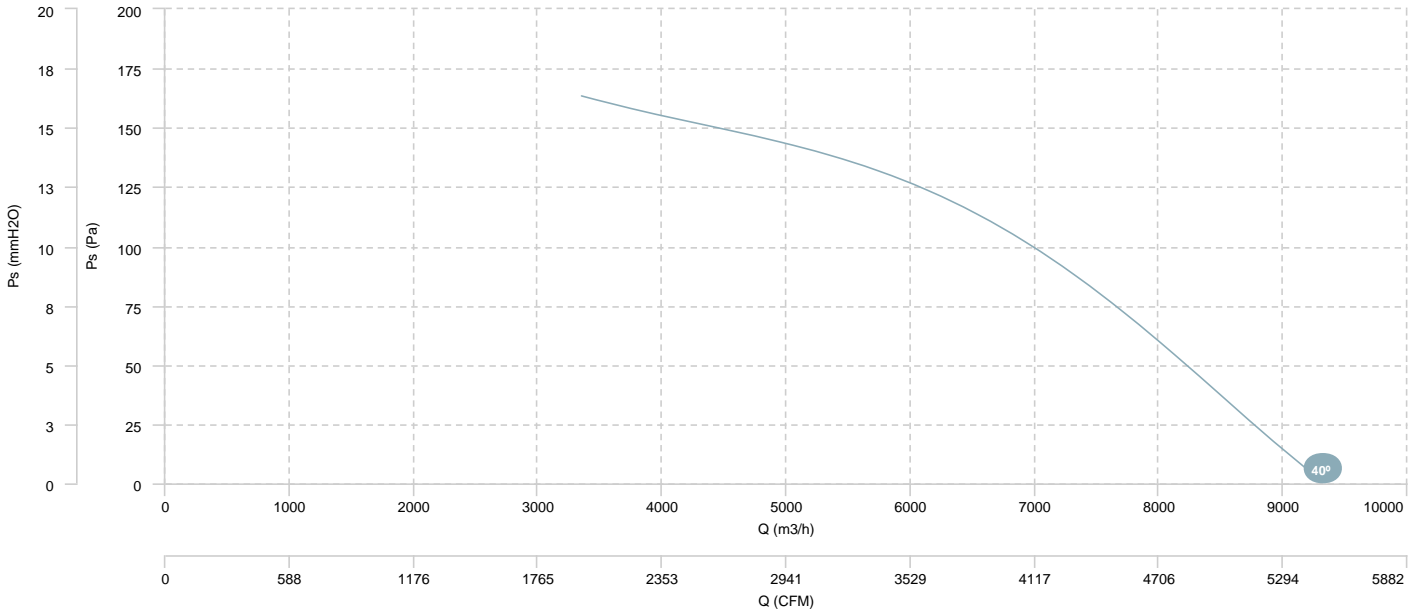

AIR FLOW - ABSORBED POWER

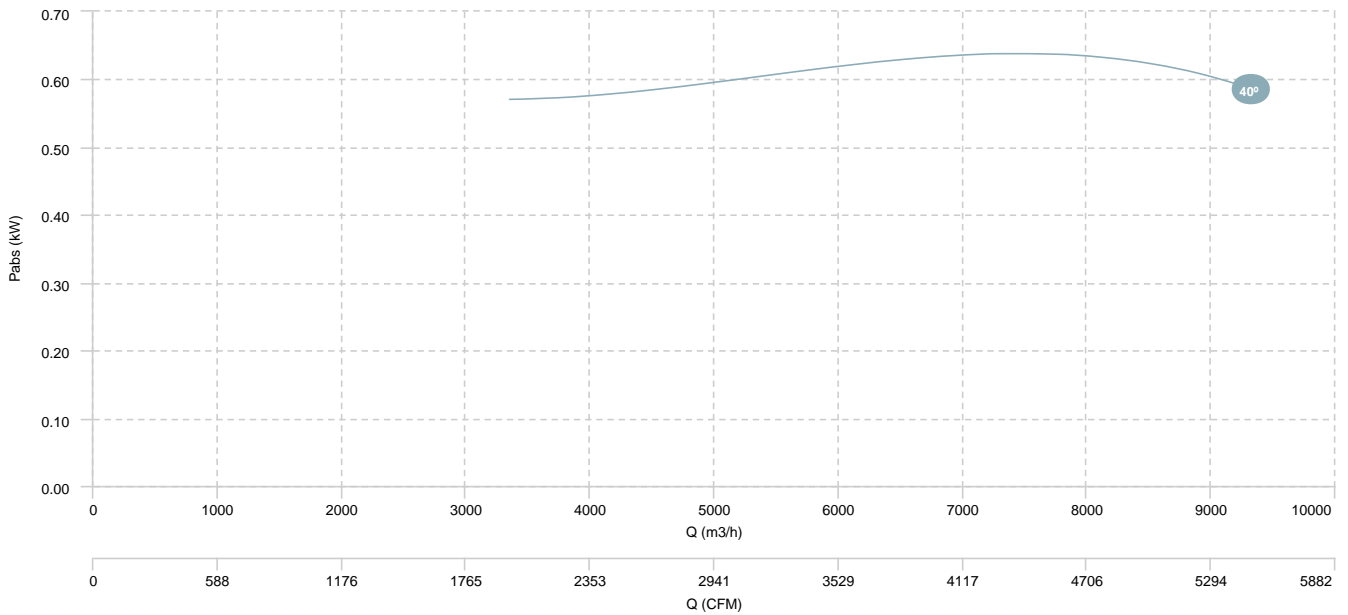

HBA 50 M6 0,13kW (A0:6)

AIR FLOW - PRESSURE

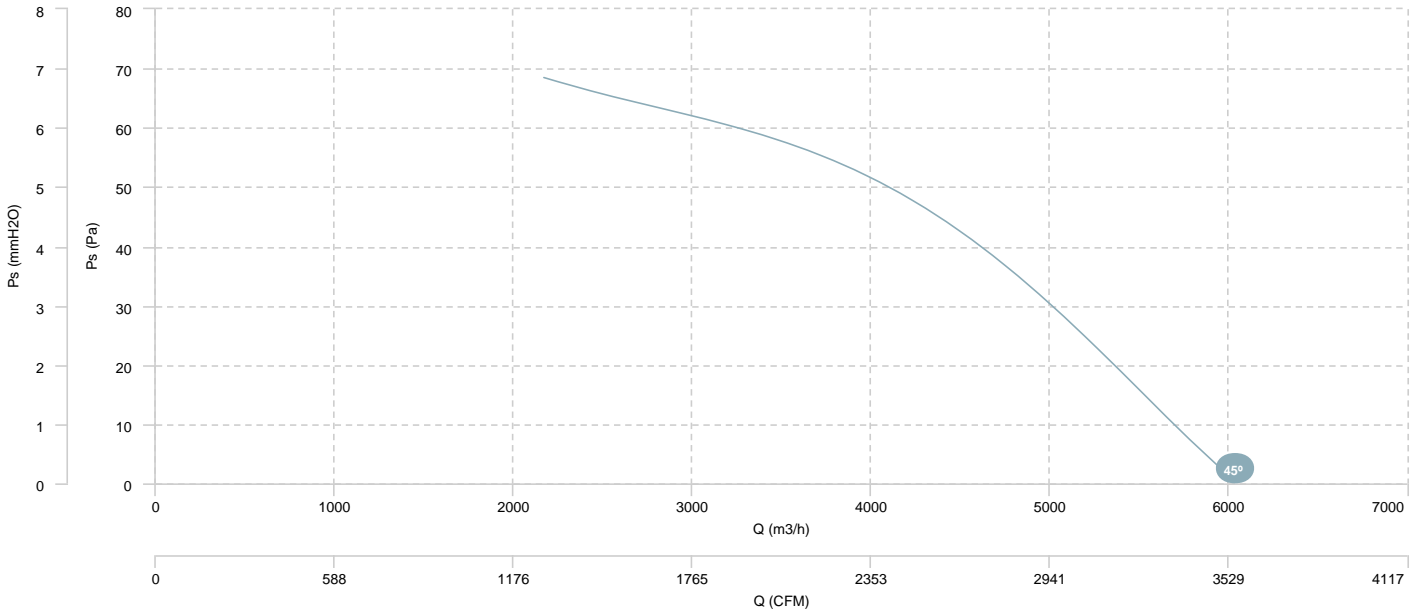

AIR FLOW - ABSORBED POWER

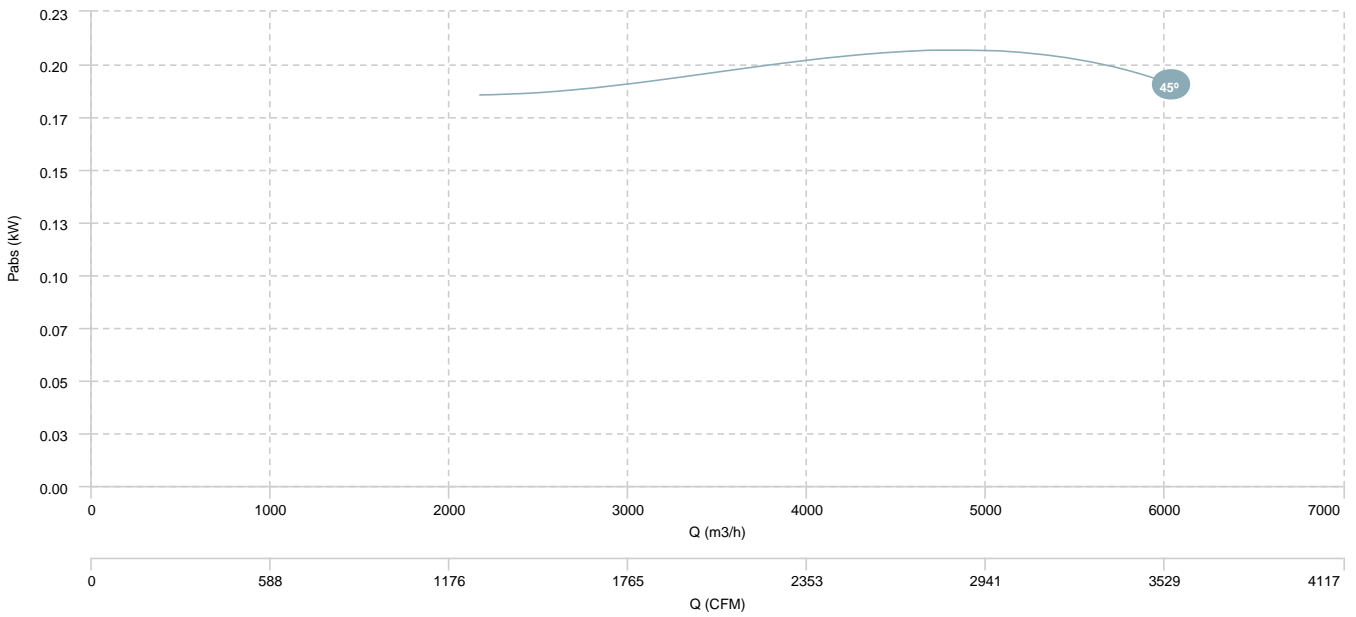

HBA 56 M4 0,55kW (A2:6)

HBA 56 M4 0,55kW (A2:6)

AIR FLOW - PRESSURE

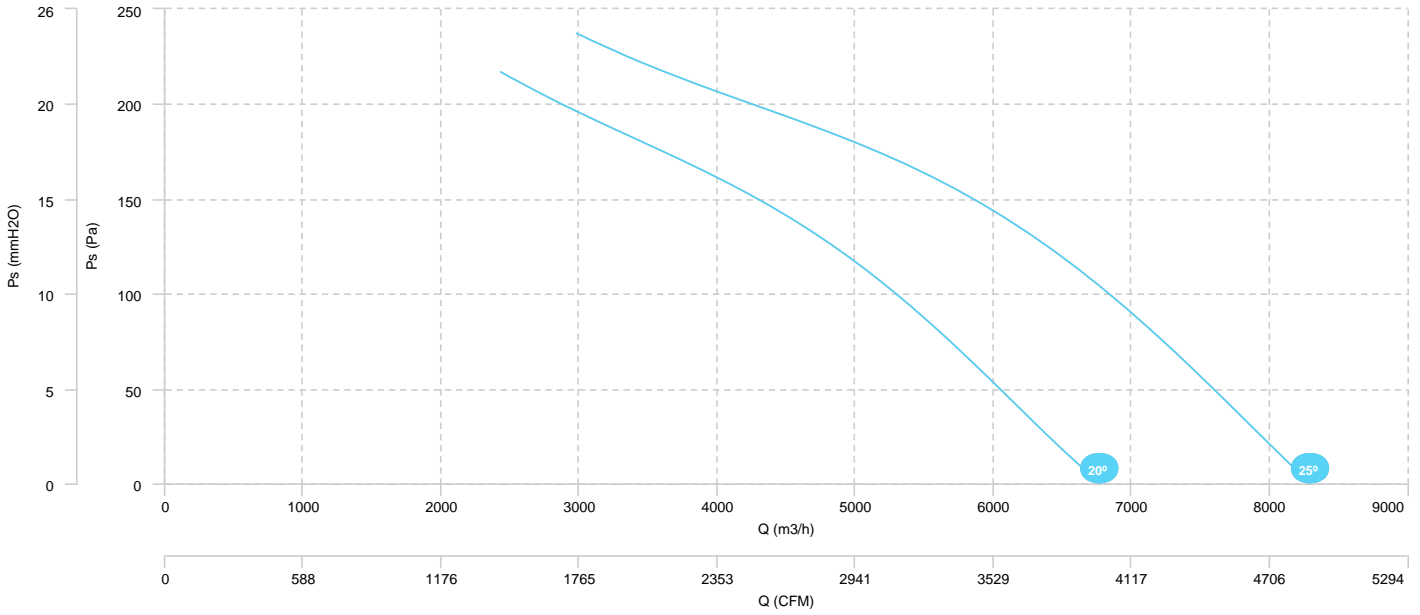

AIR FLOW - ABSORBED POWER

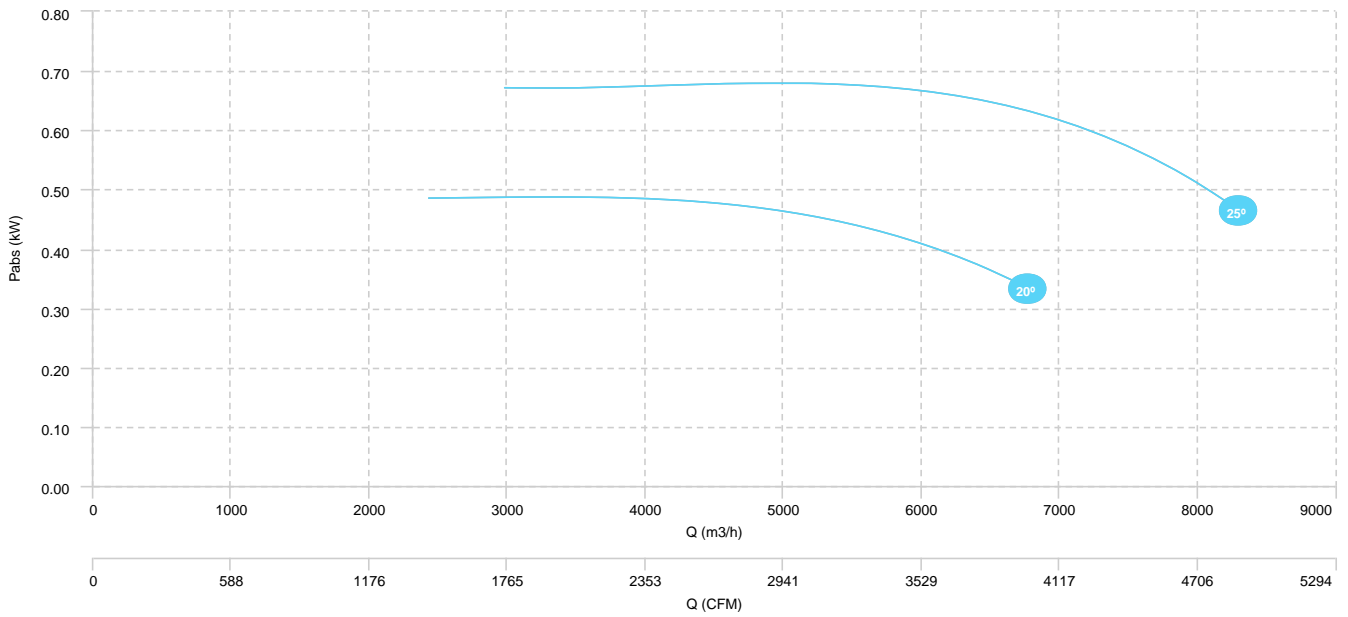



HBA 56 M4 0,37kW (A5:6)

HBA 56 M4 0,55kW (A5:6)

AIR FLOW - PRESSURE

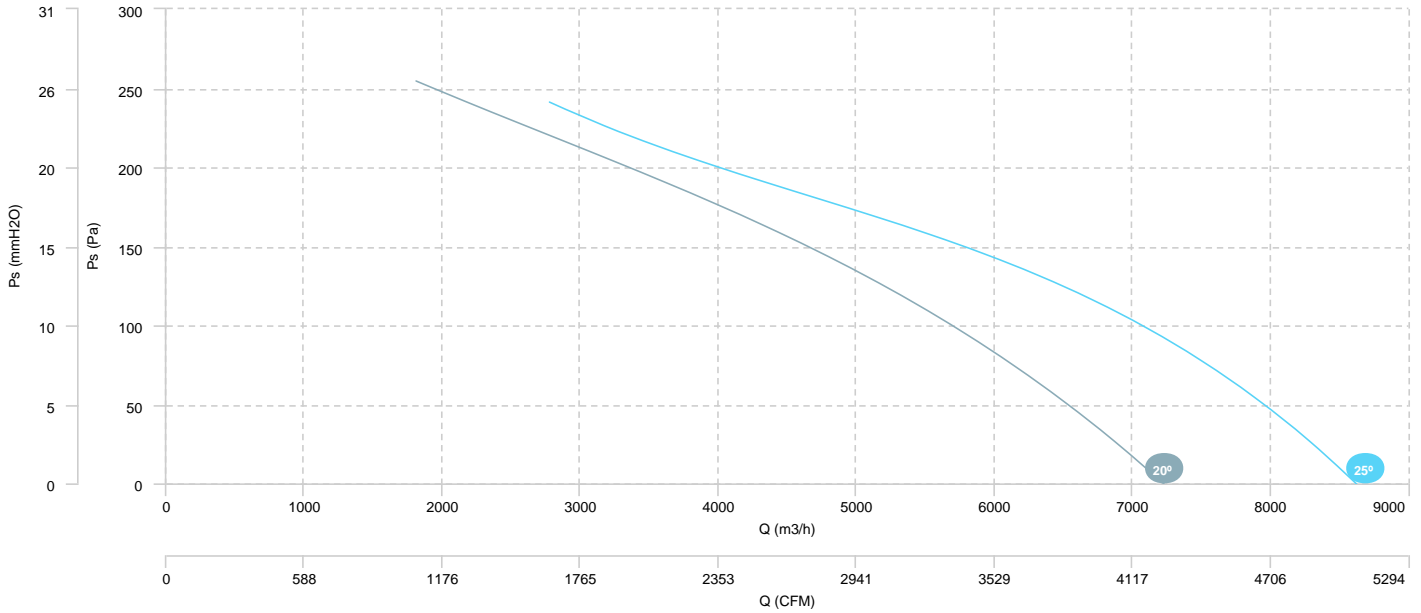

AIR FLOW - ABSORBED POWER

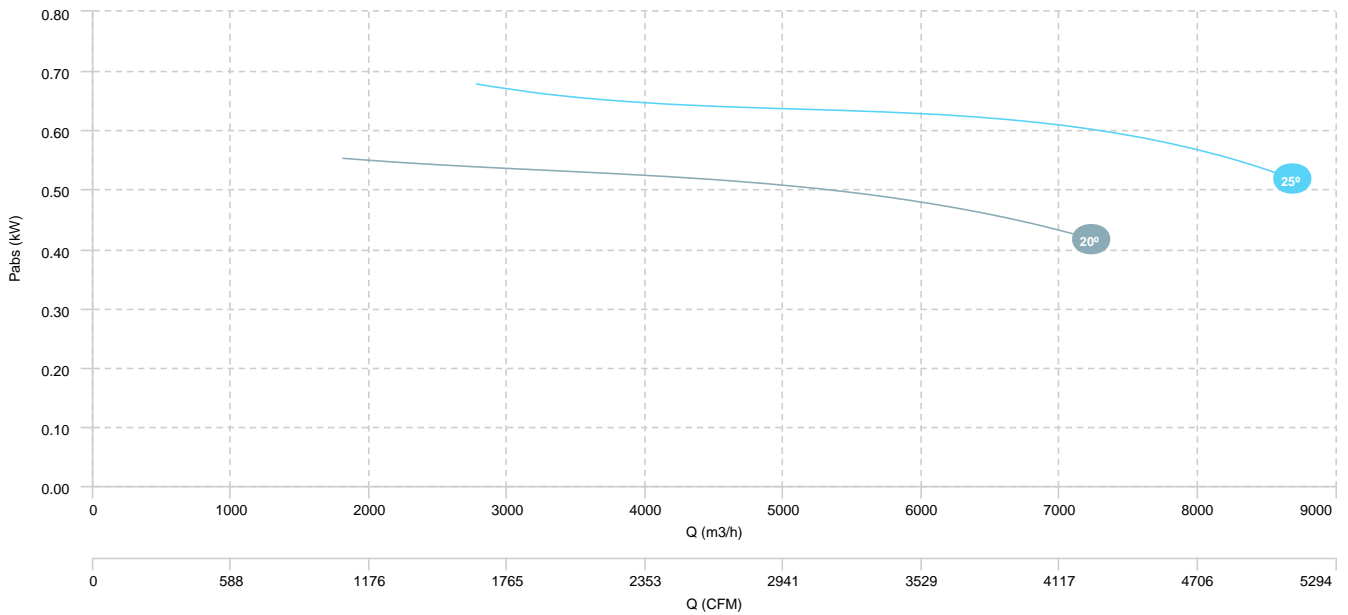

HBA 56 M6 0,25kW (A5:6)

HBA 56 M6 0,37kW (A5:6)

## AIR FLOW - PRESSURE

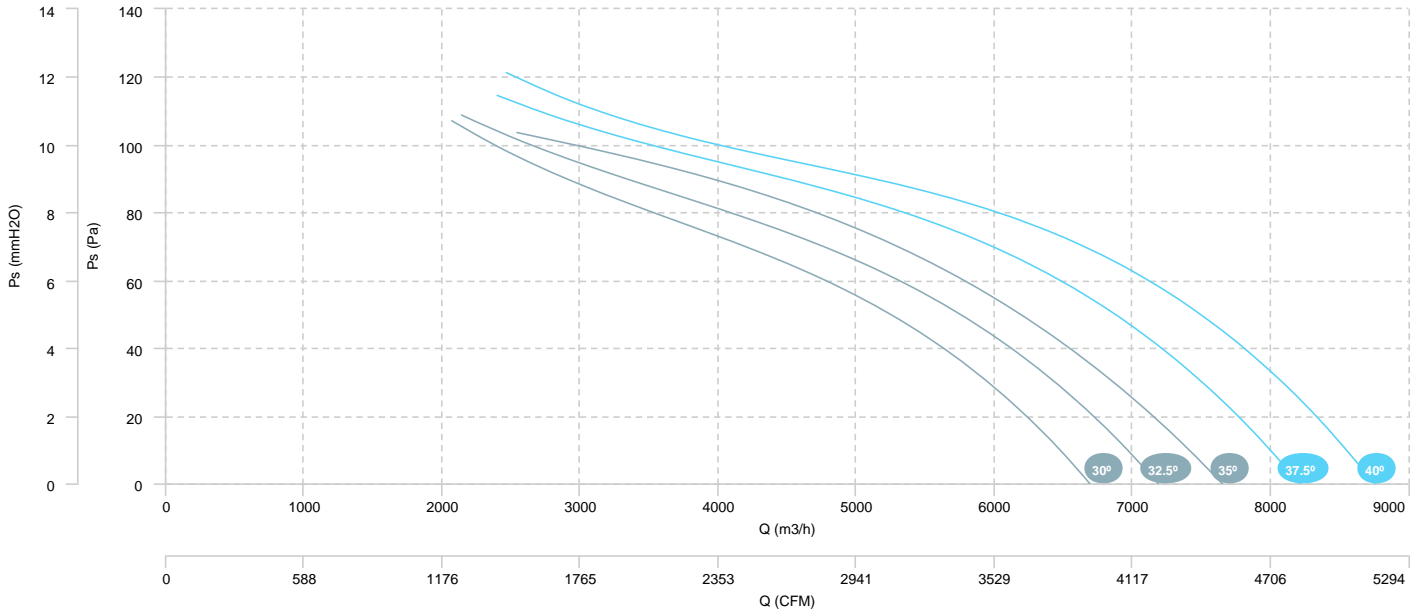

## AIR FLOW - ABSORBED POWER

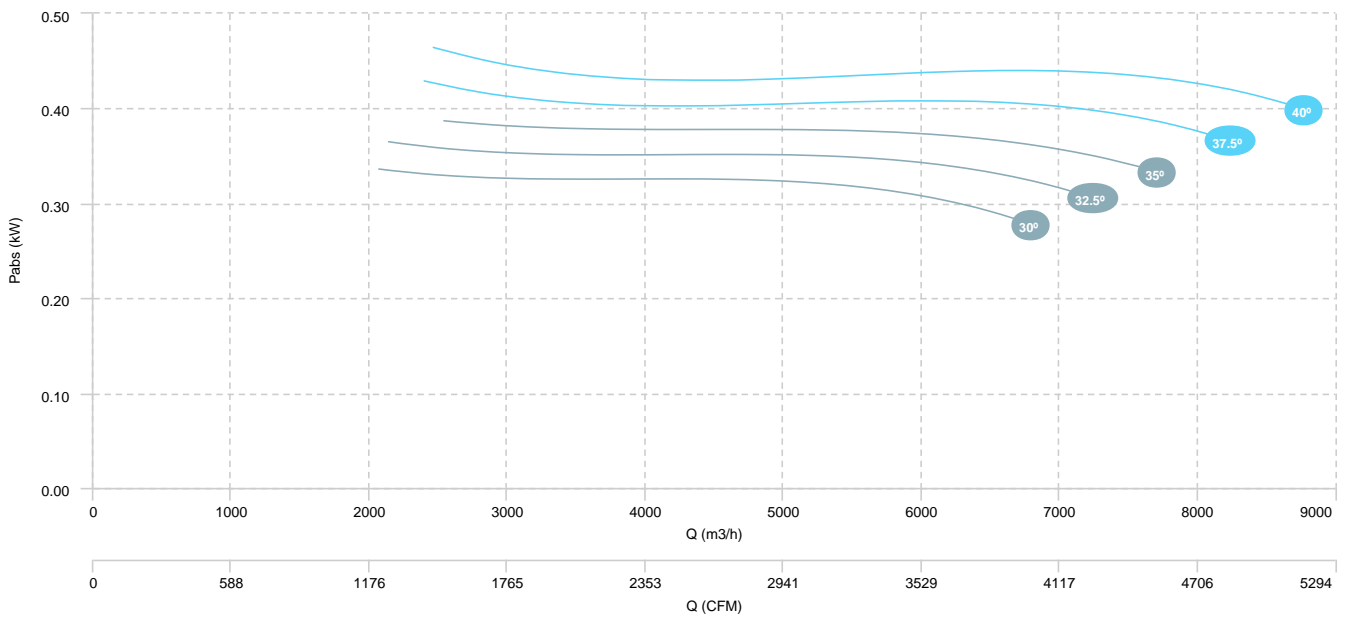

HBA 56 M6 0,25kW (A2:6)

HBA 56 M6 0,25kW (A2:6)

HBA 56 M6 0,37kW (A2:6)

## AIR FLOW - PRESSURE

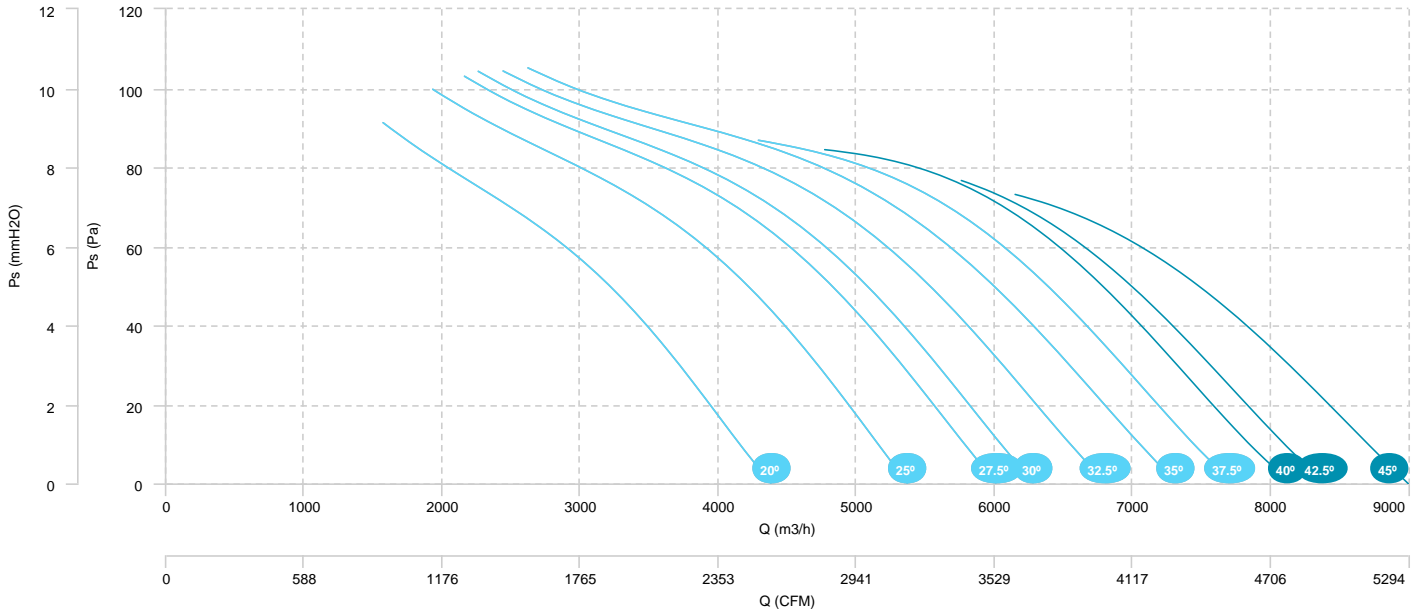

## AIR FLOW - ABSORBED POWER

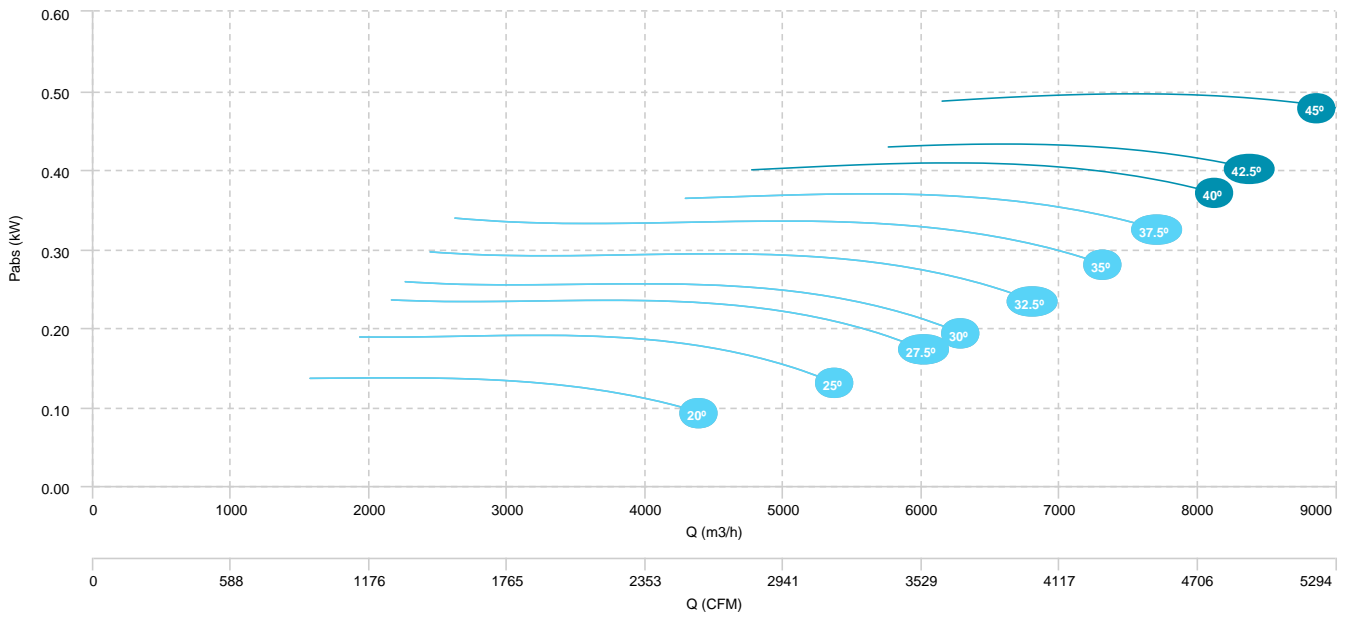

HBA 63 M6 0,37kW (A5:6)

HBA 63 M6 0,55kW (A5:6)

AIR FLOW - PRESSURE

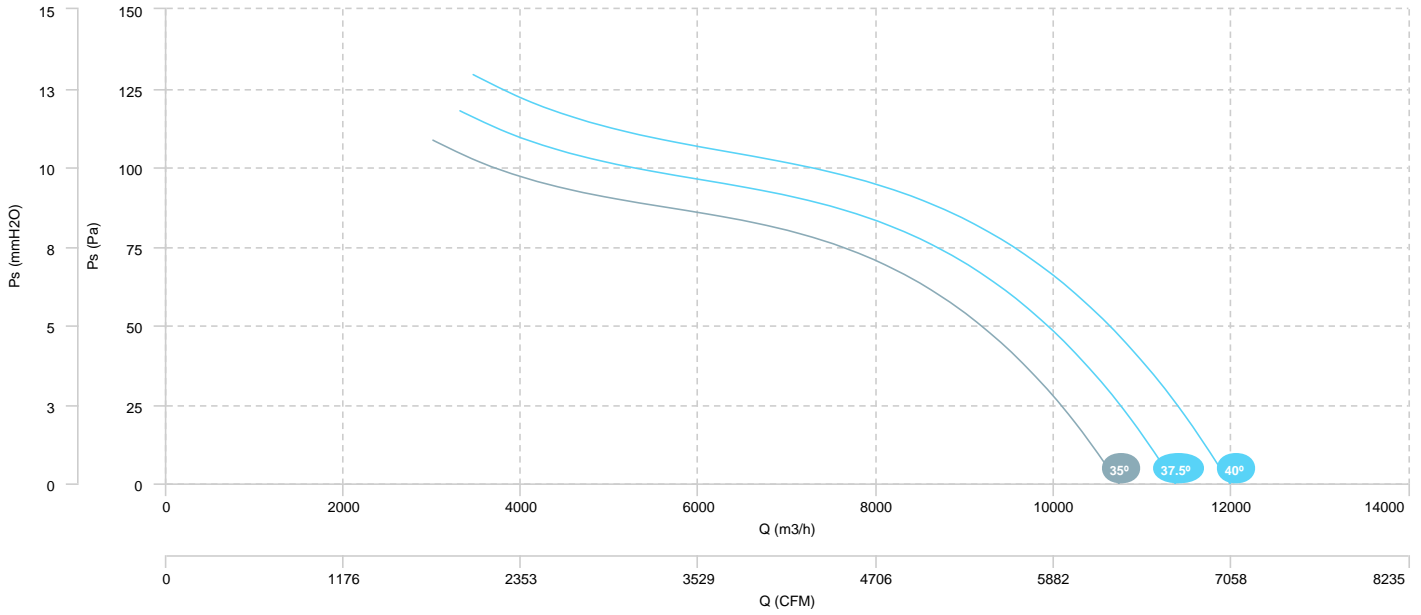

AIR FLOW - ABSORBED POWER

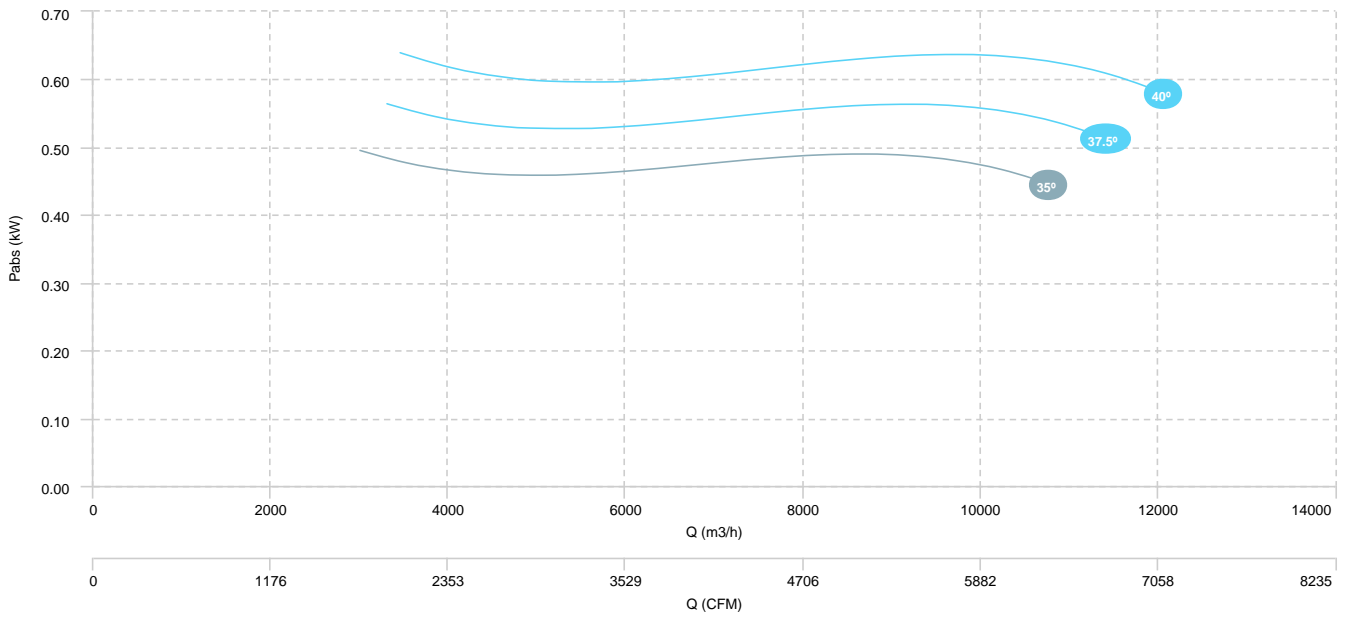

HBA 63 M6 0,55kW (A2:9)

AIR FLOW - PRESSURE

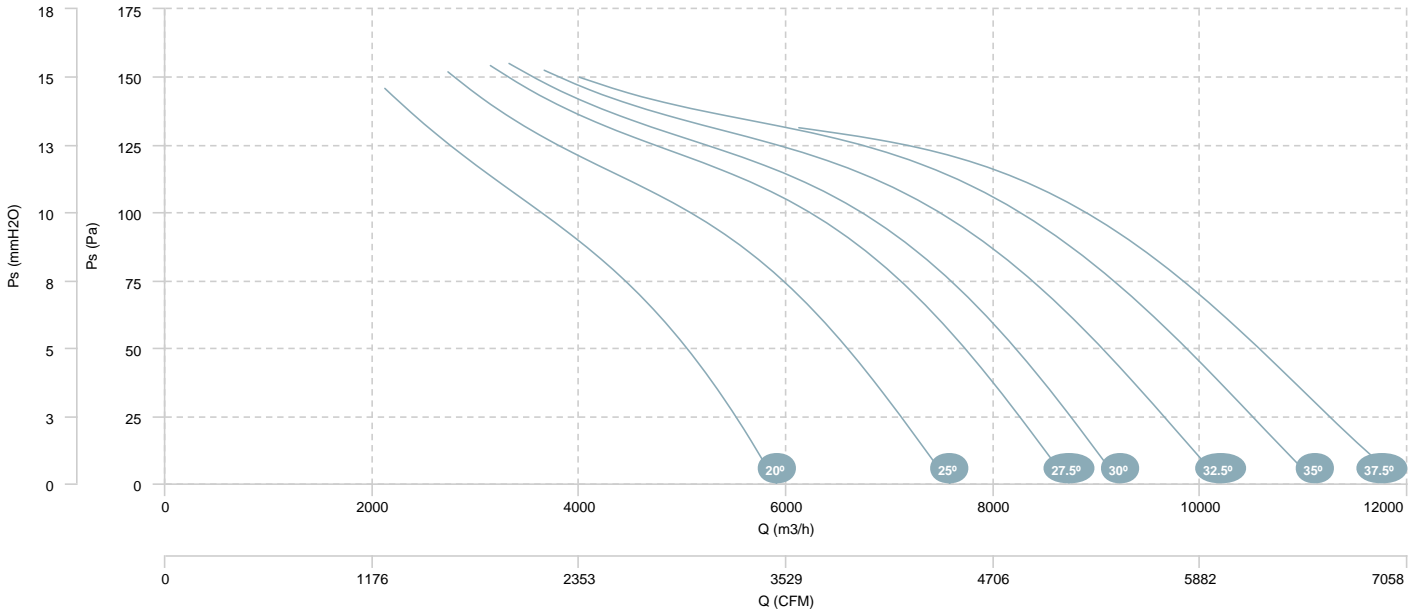

AIR FLOW - ABSORBED POWER

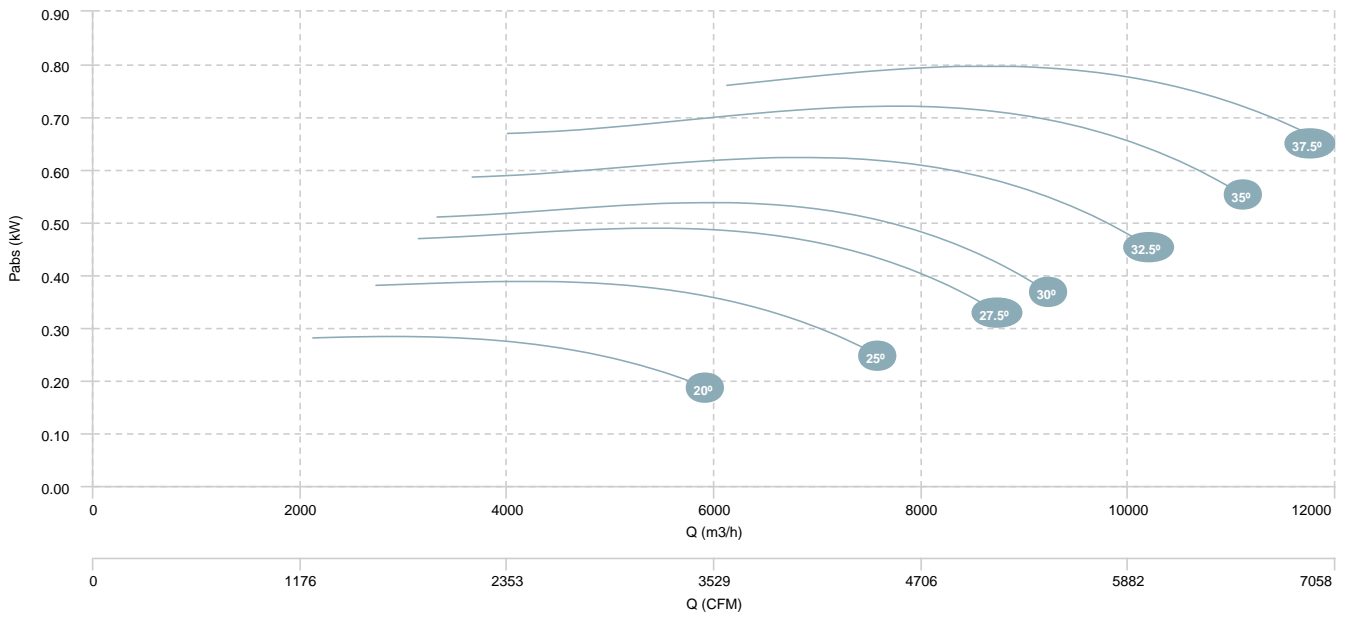

HBA 71 M6 0,55kW (A2:9)

AIR FLOW - PRESSURE

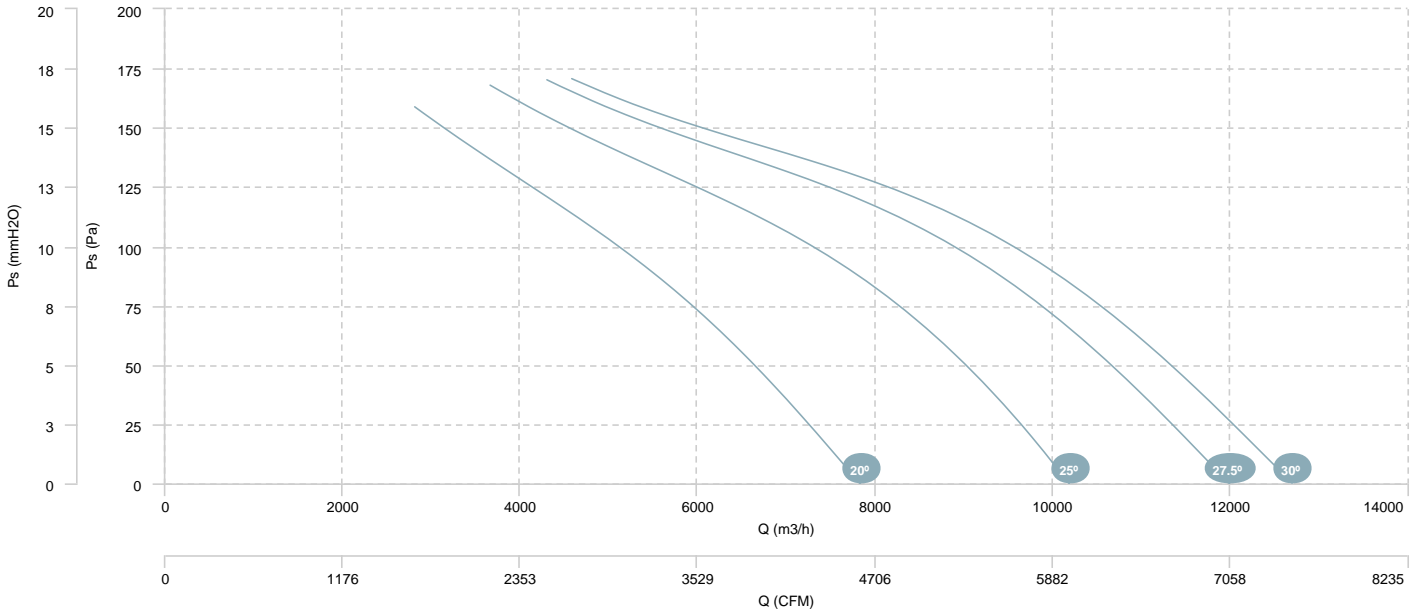

AIR FLOW - ABSORBED POWER

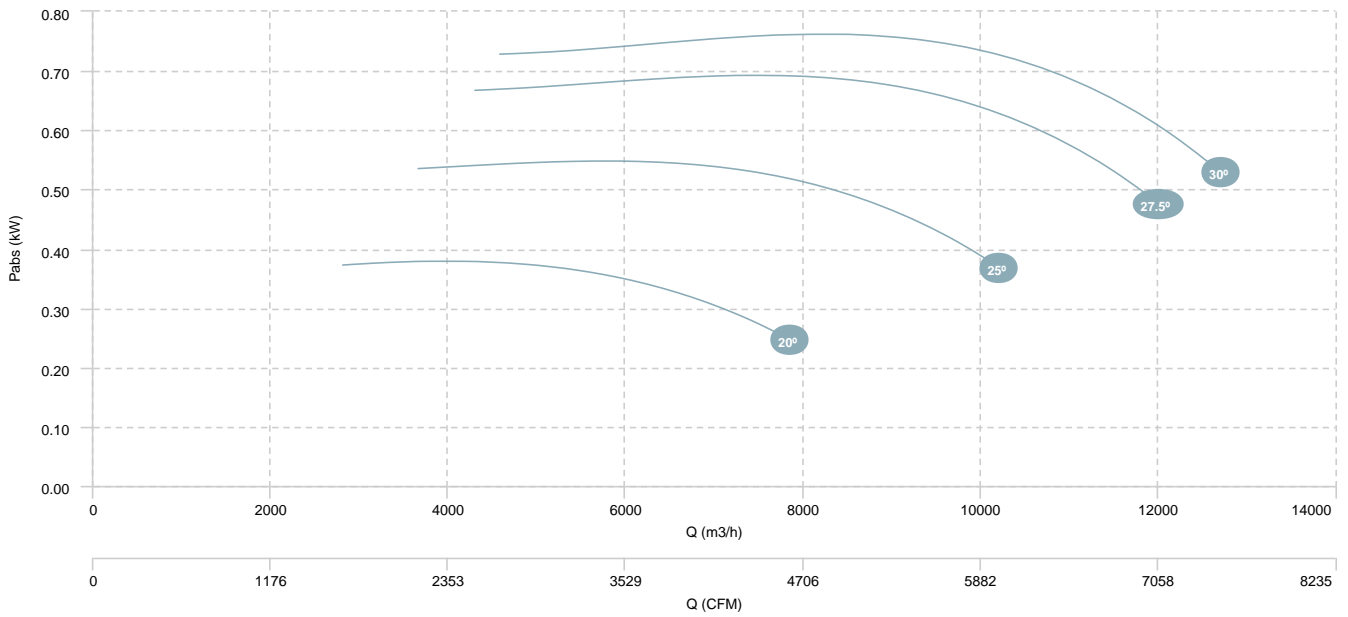

HBA 71 M6 0,55kW (A2:6)

AIR FLOW - PRESSURE

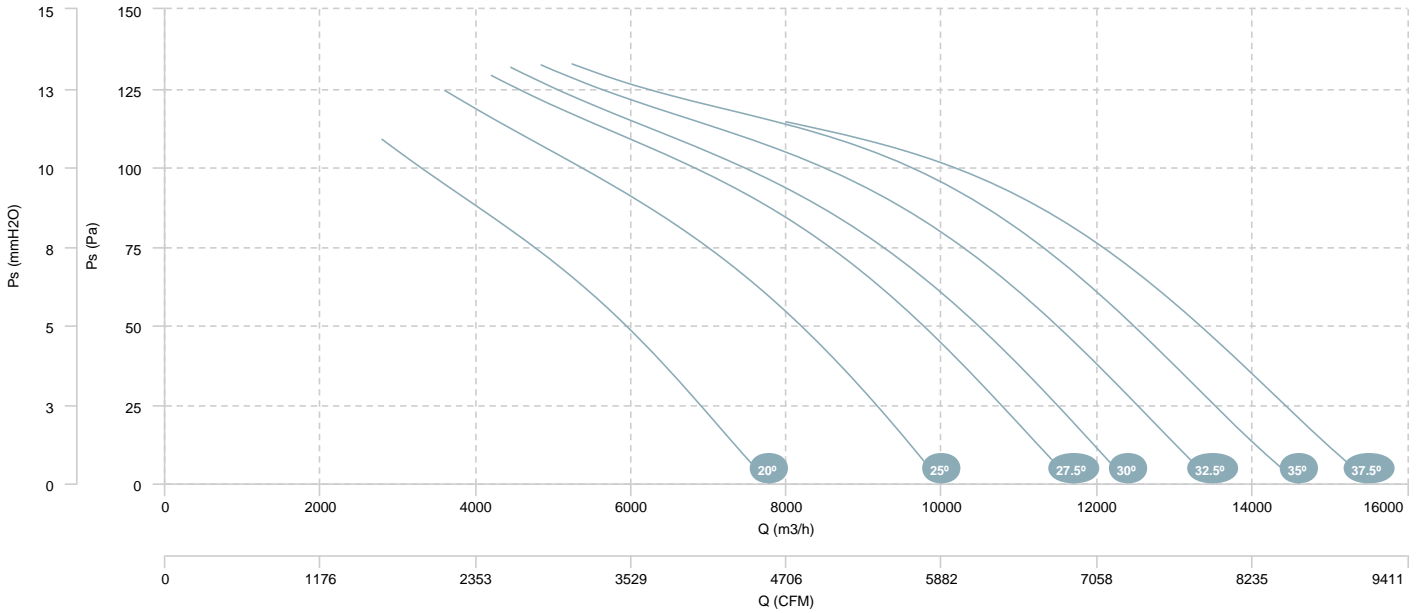

AIR FLOW - ABSORBED POWER

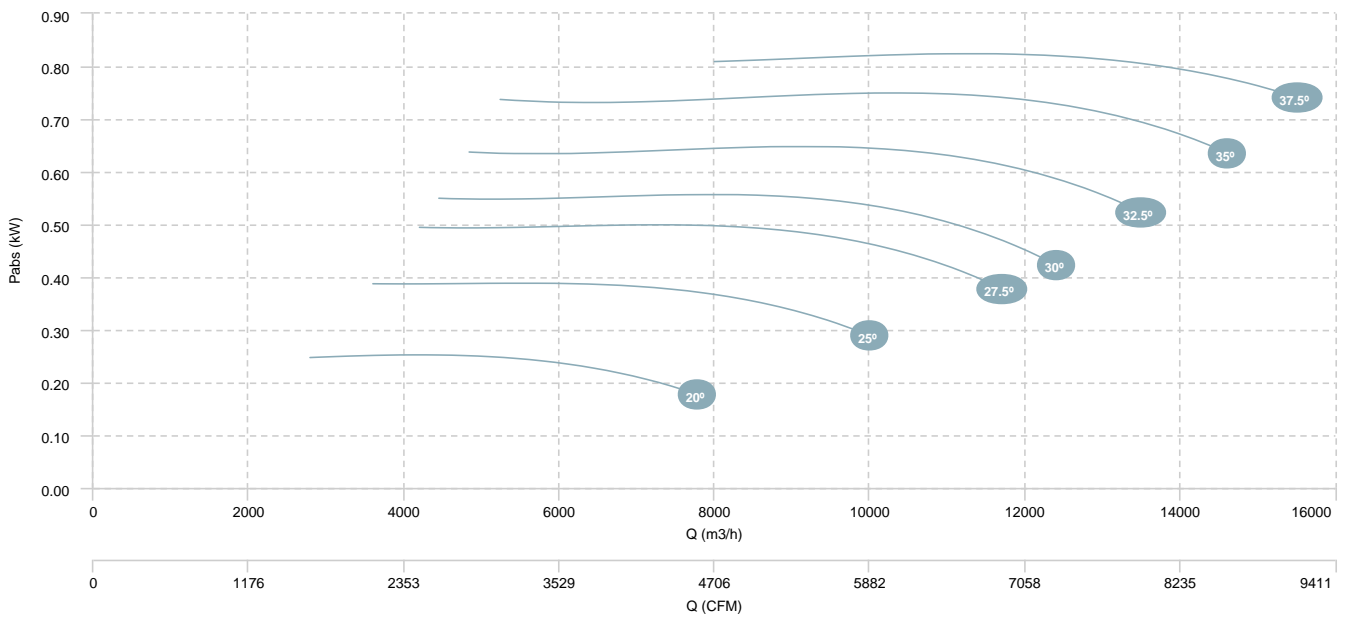

HBA 35 T2 0,55kW (A0:6)

HBA 35 T2 1,1kW (A0:6)

## AIR FLOW - PRESSURE

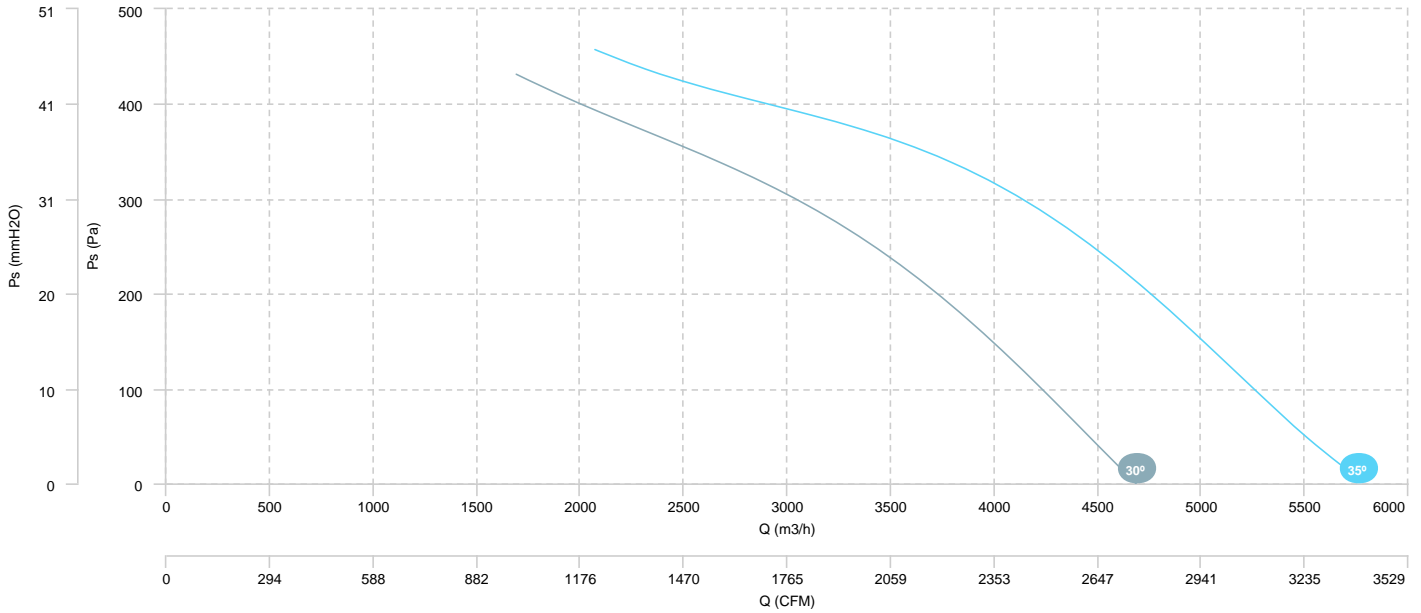

## AIR FLOW - ABSORBED POWER

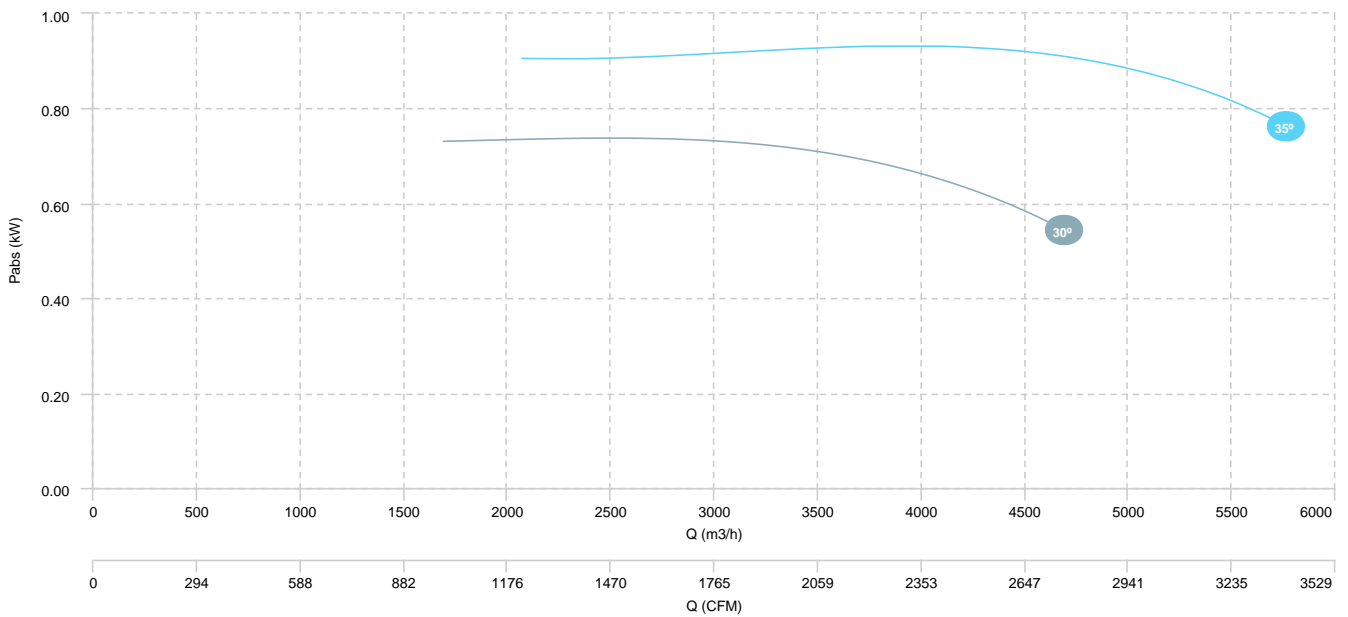



HBA 35 T4 0,12kW (A0:6)

AIR FLOW - PRESSURE

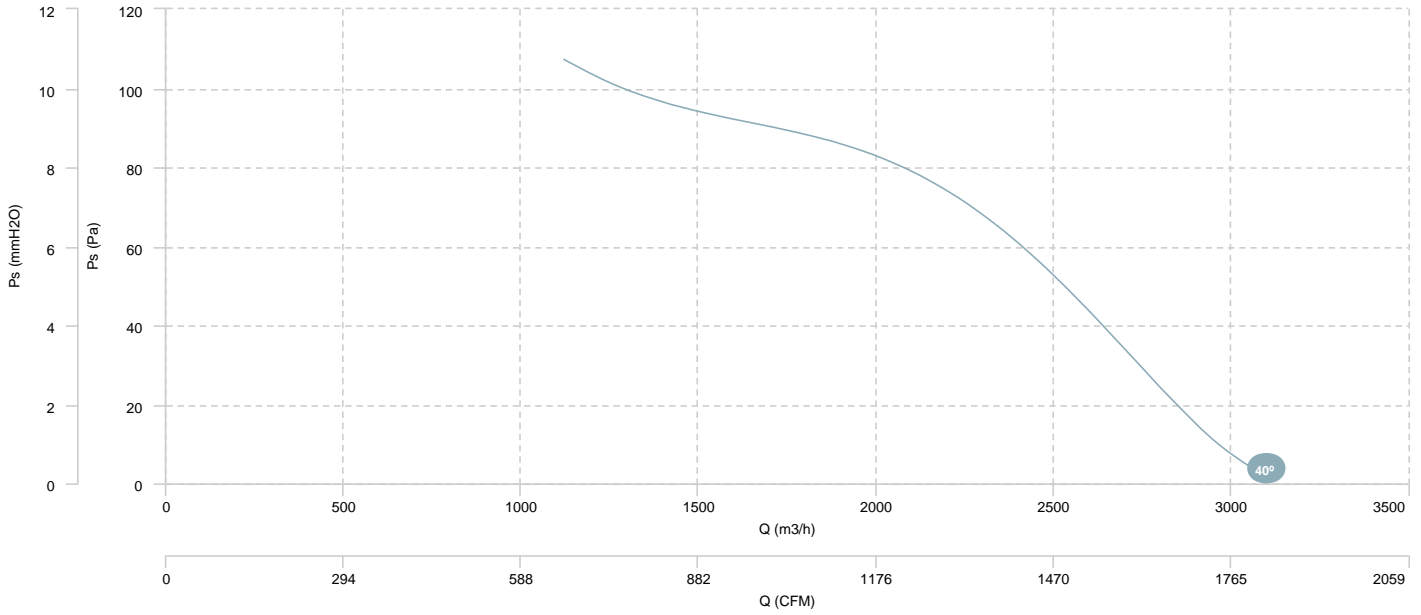

AIR FLOW - ABSORBED POWER

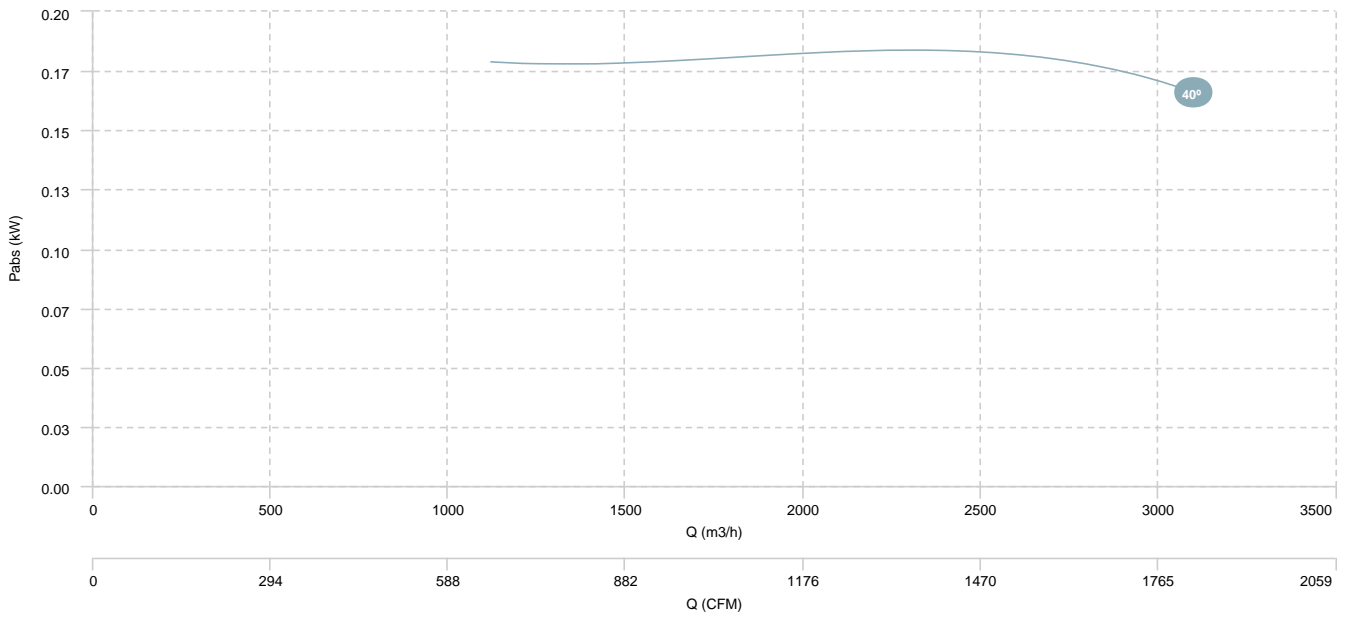

HBA 40 T2 1,1kW (A0:6)

AIR FLOW - PRESSURE

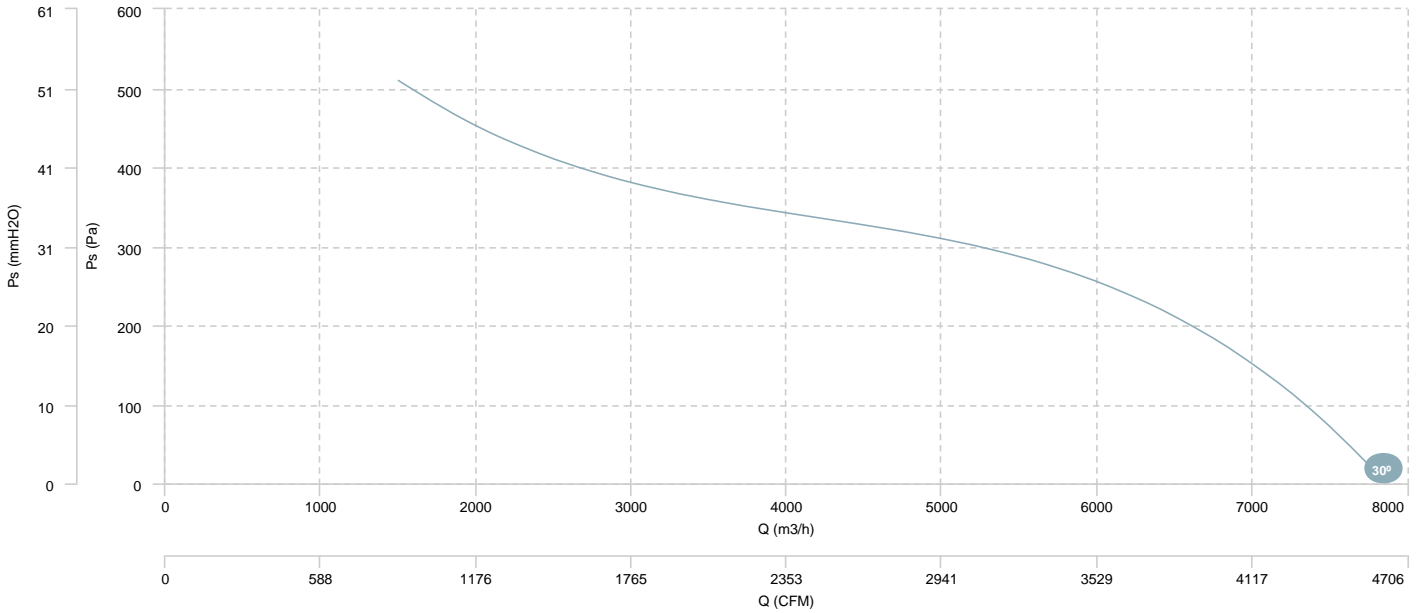

AIR FLOW - ABSORBED POWER

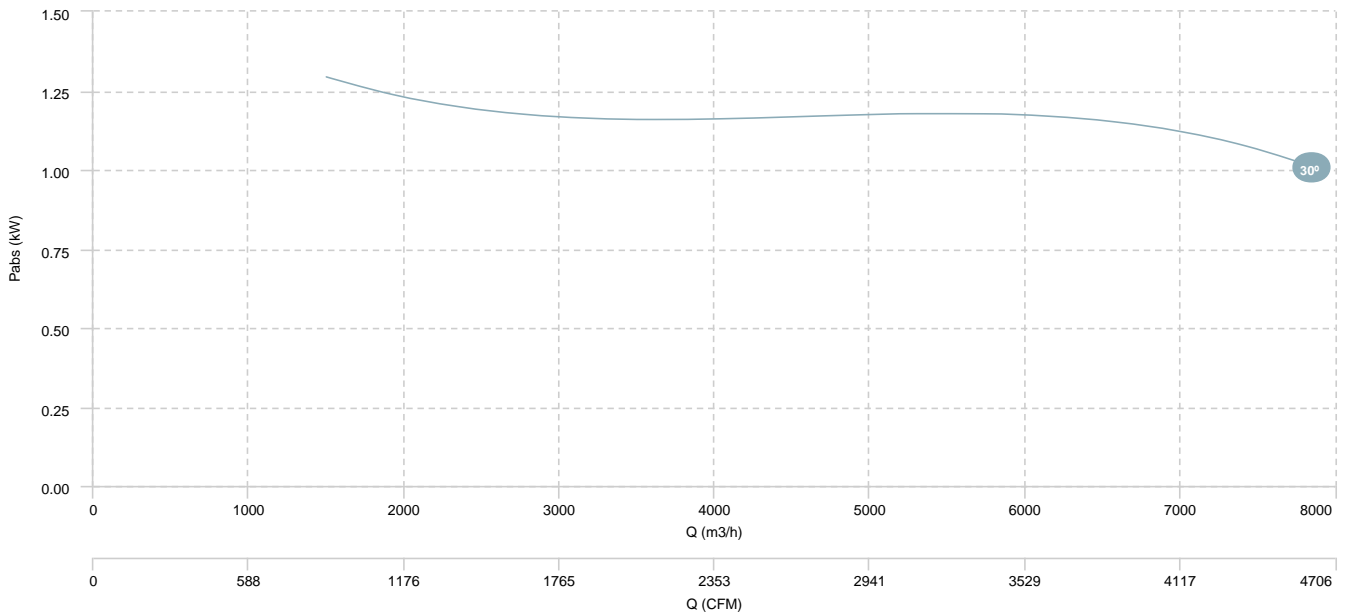

HBA 40 T4 0,25kW (A0:6)

AIR FLOW - PRESSURE

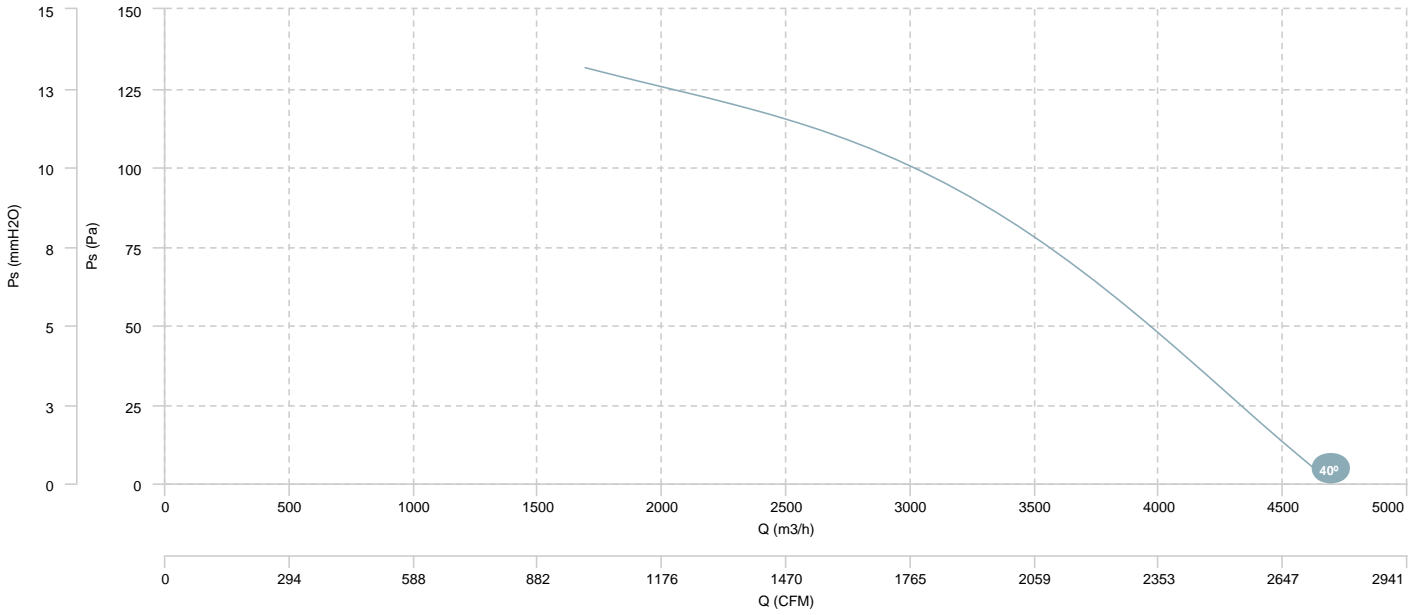

AIR FLOW - ABSORBED POWER

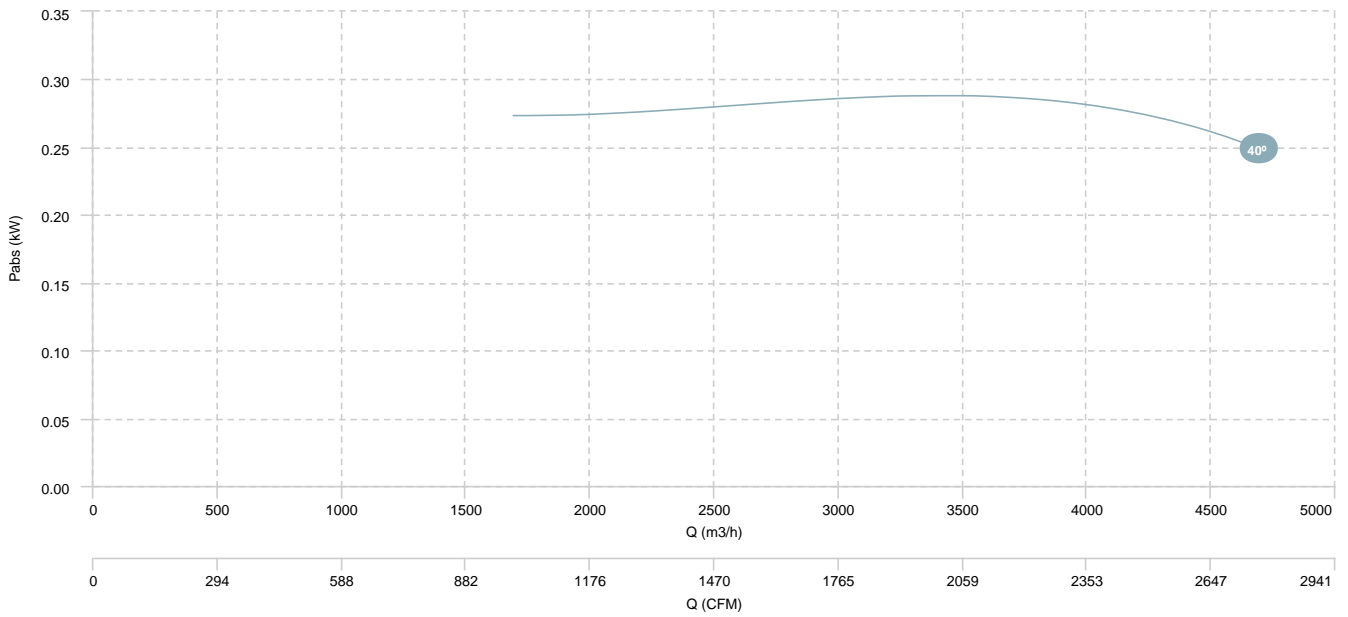

HBA 40 T6 0,12kW (A0:6)

AIR FLOW - PRESSURE

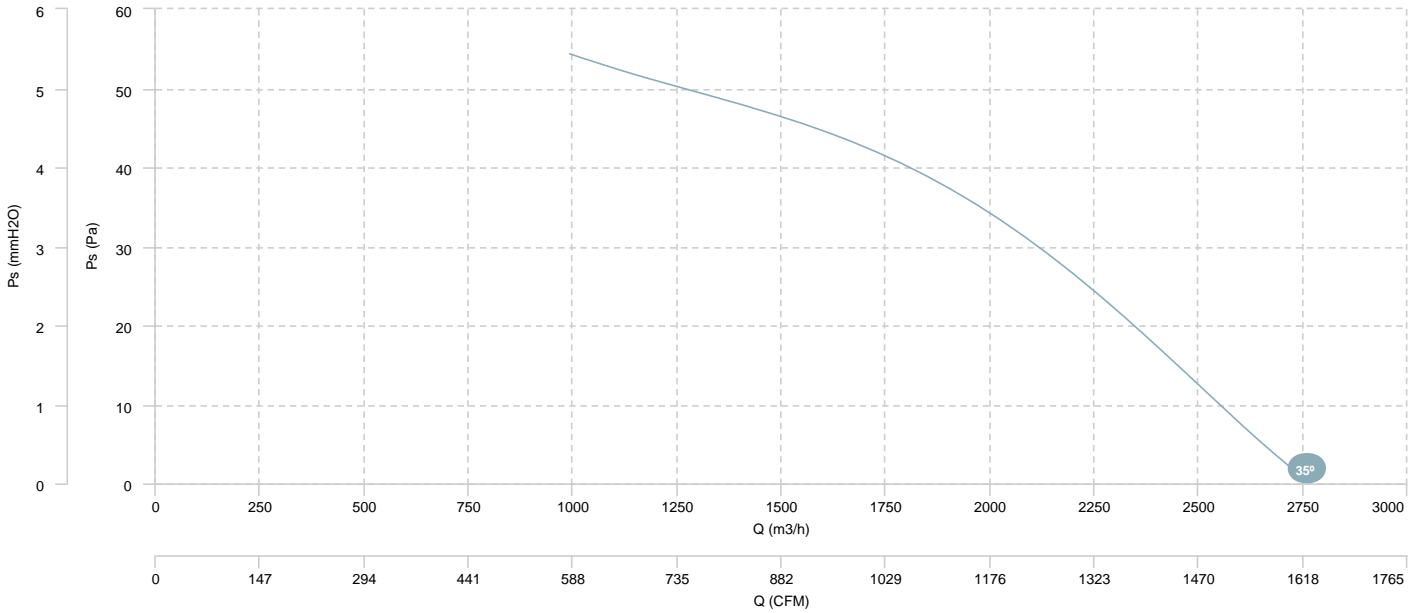

AIR FLOW - ABSORBED POWER

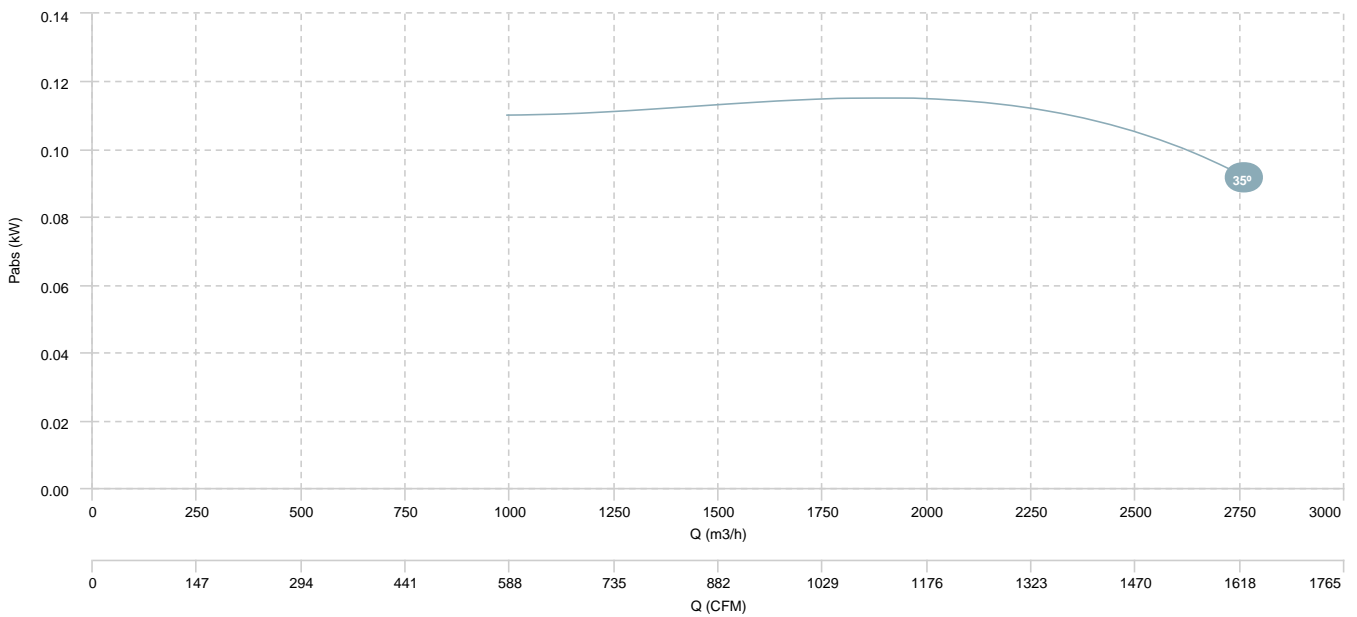

HBA 45 T2 1,5kW (A0:6)

HBA 45 T2 2,2kW (A0:6)

AIR FLOW - PRESSURE

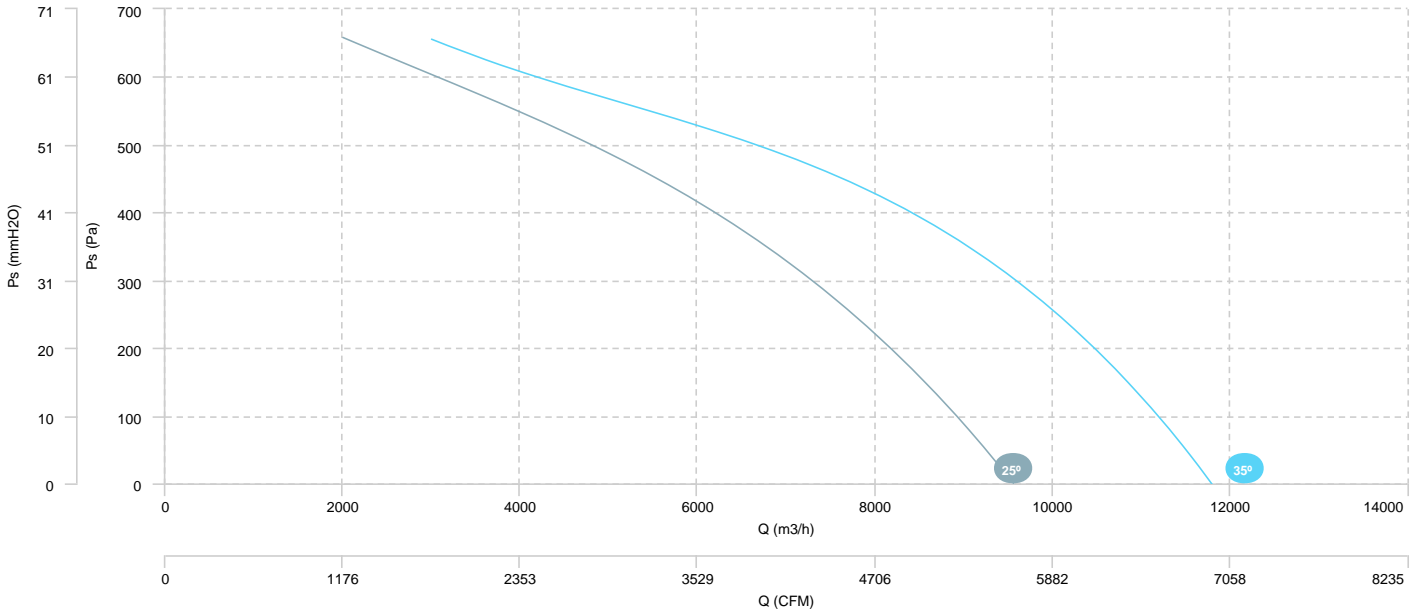

AIR FLOW - ABSORBED POWER

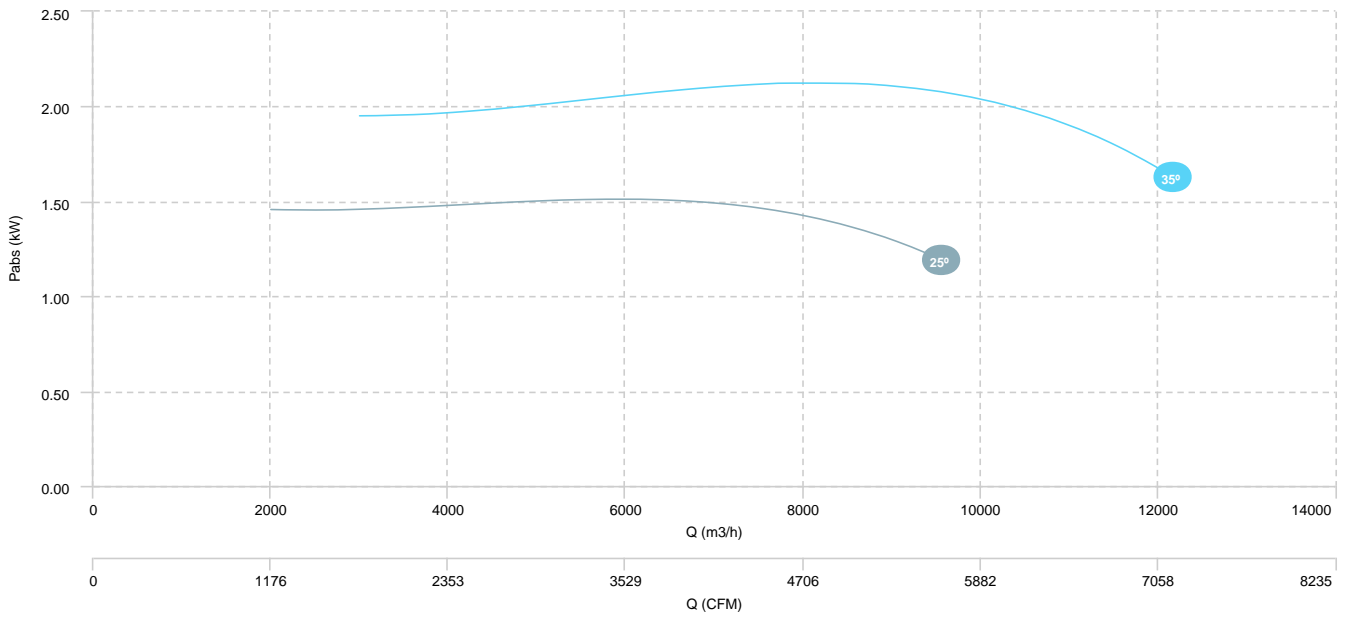

HBA 45 T4 0,55kW (A0:6)

AIR FLOW - PRESSURE

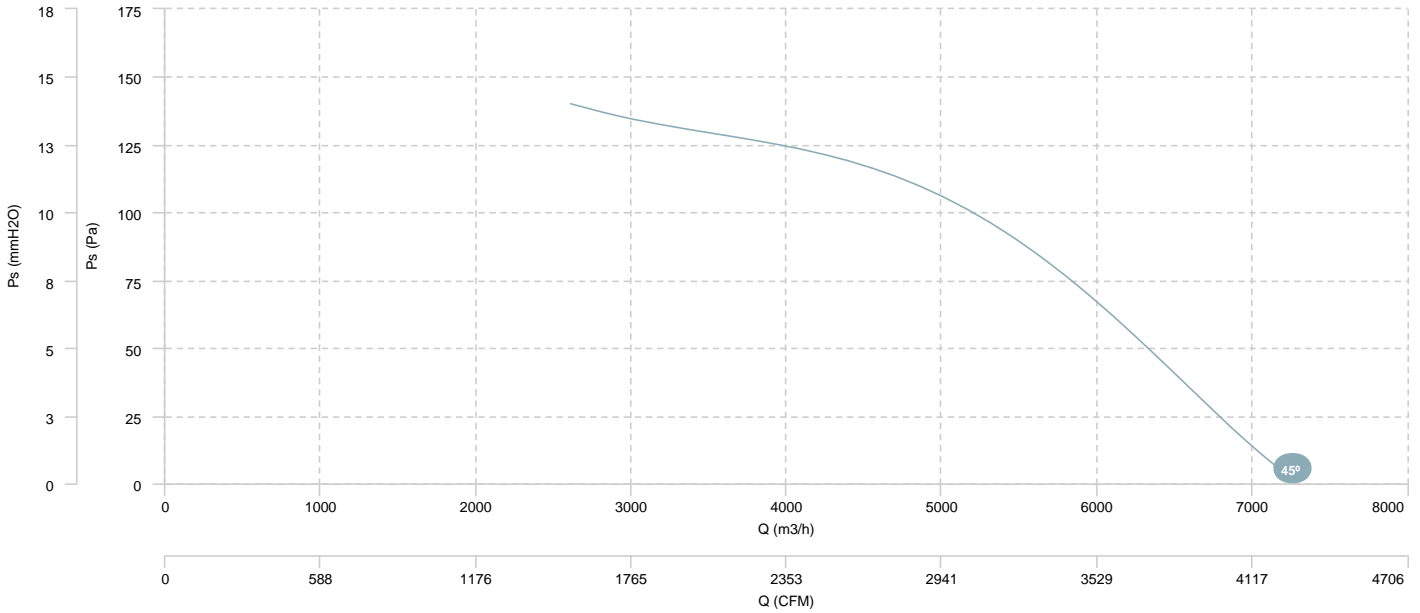

AIR FLOW - ABSORBED POWER

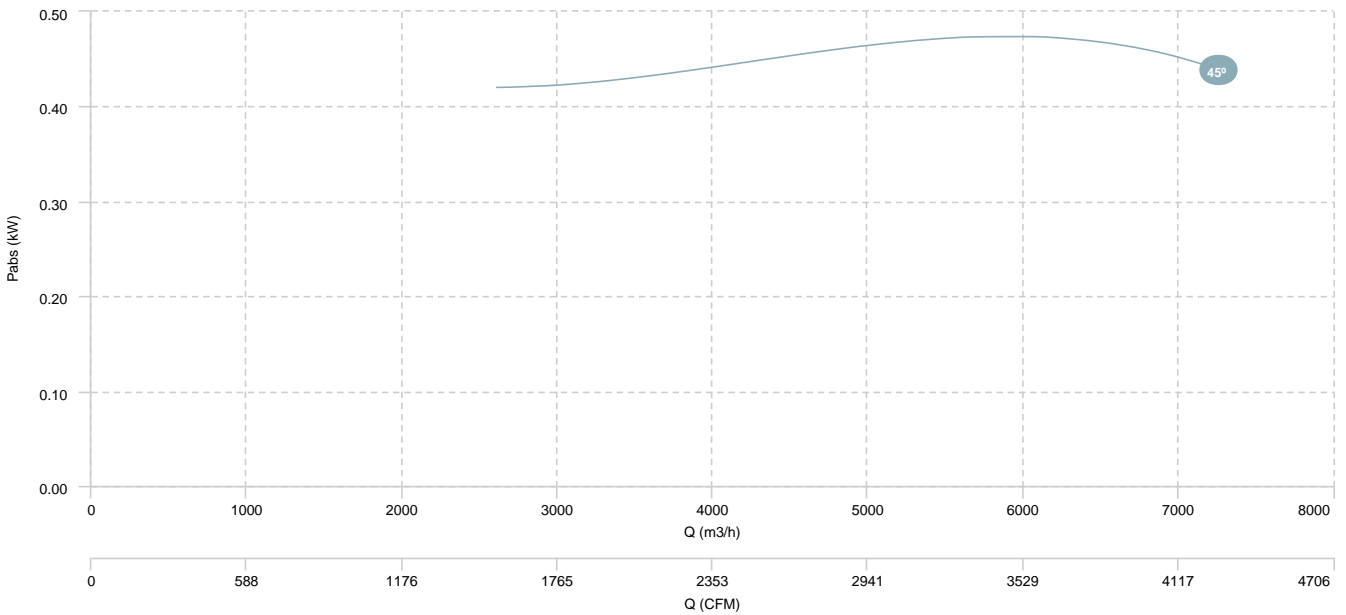

HBA 45 T6 0,13kW (A0:6)

AIR FLOW - PRESSURE

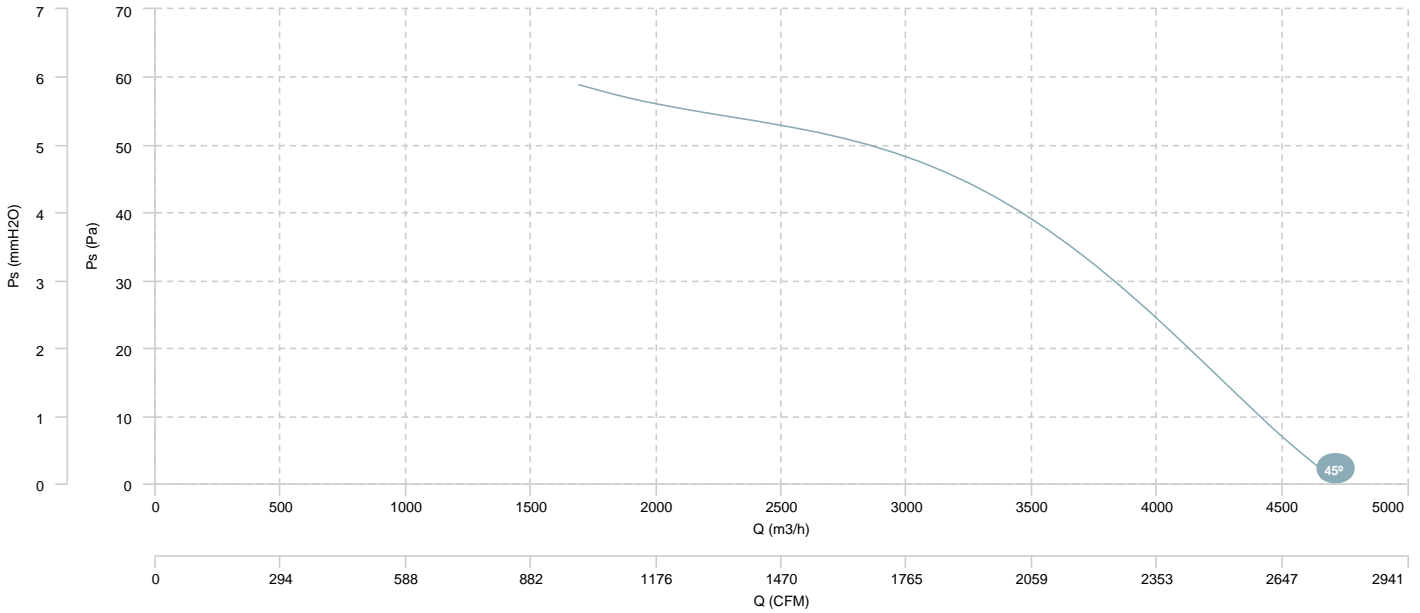

AIR FLOW - ABSORBED POWER

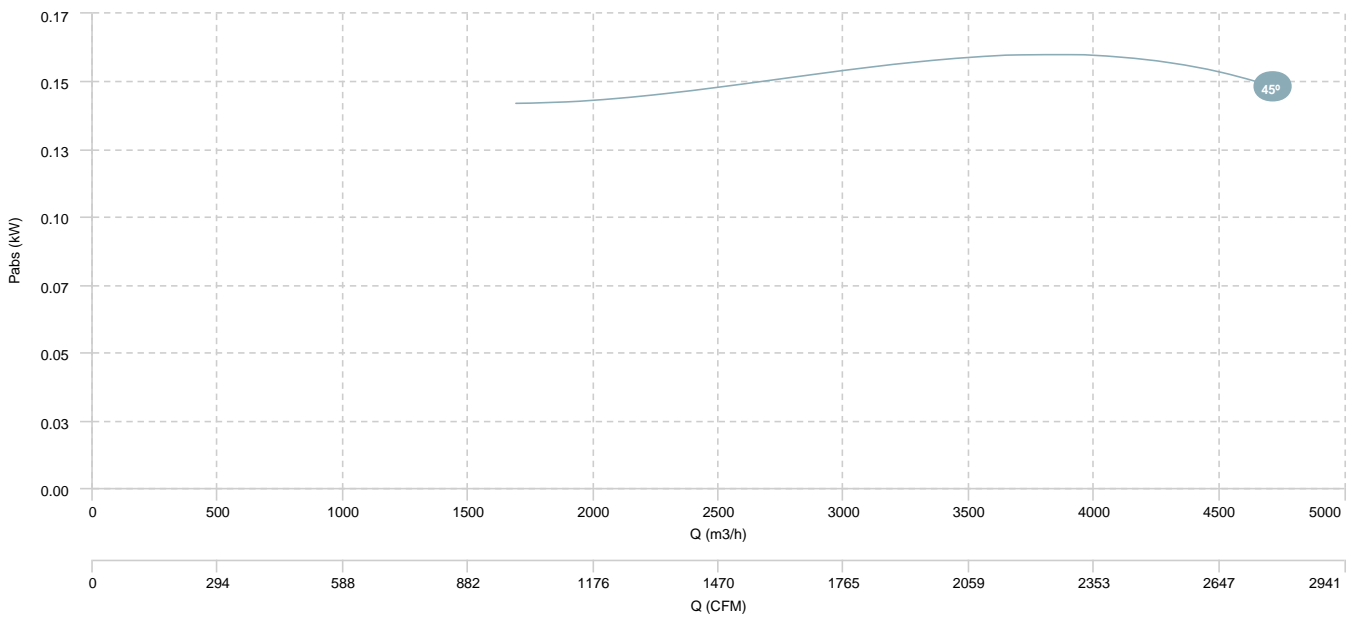

HBA 45 T4/T8 0,33/0,04kW (A0:6)

AIR FLOW - PRESSURE (4 poles)

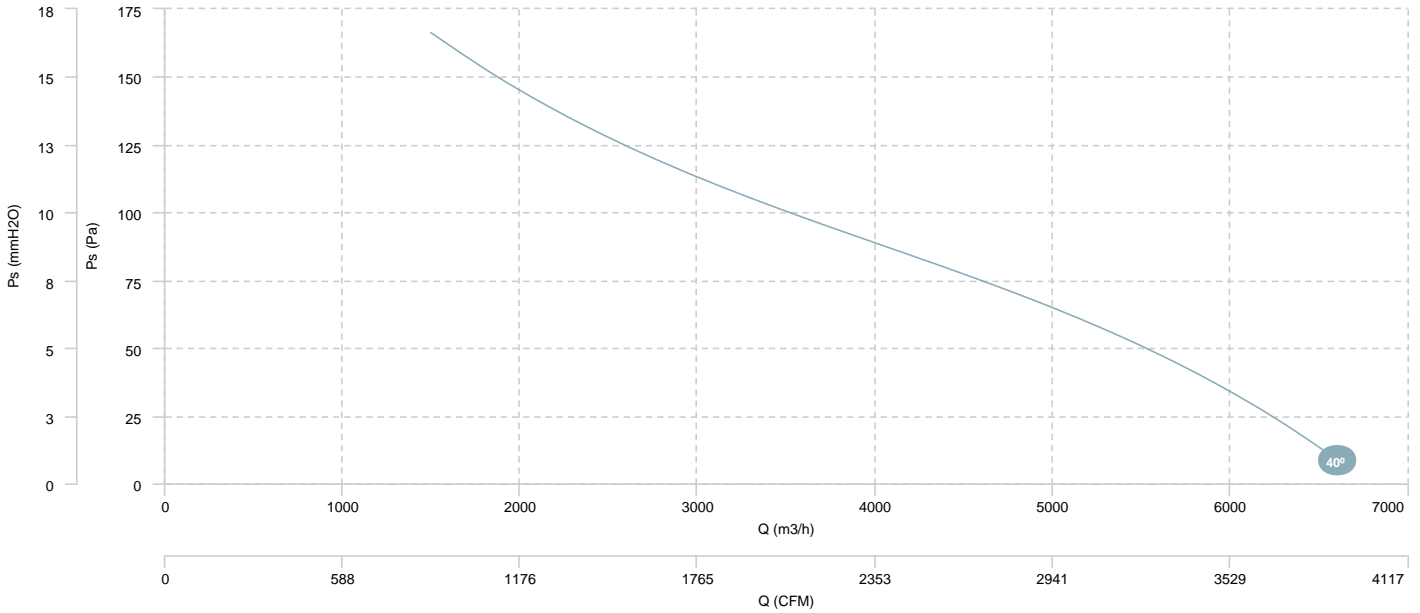

AIR FLOW - ABSORBED POWER (4 poles)

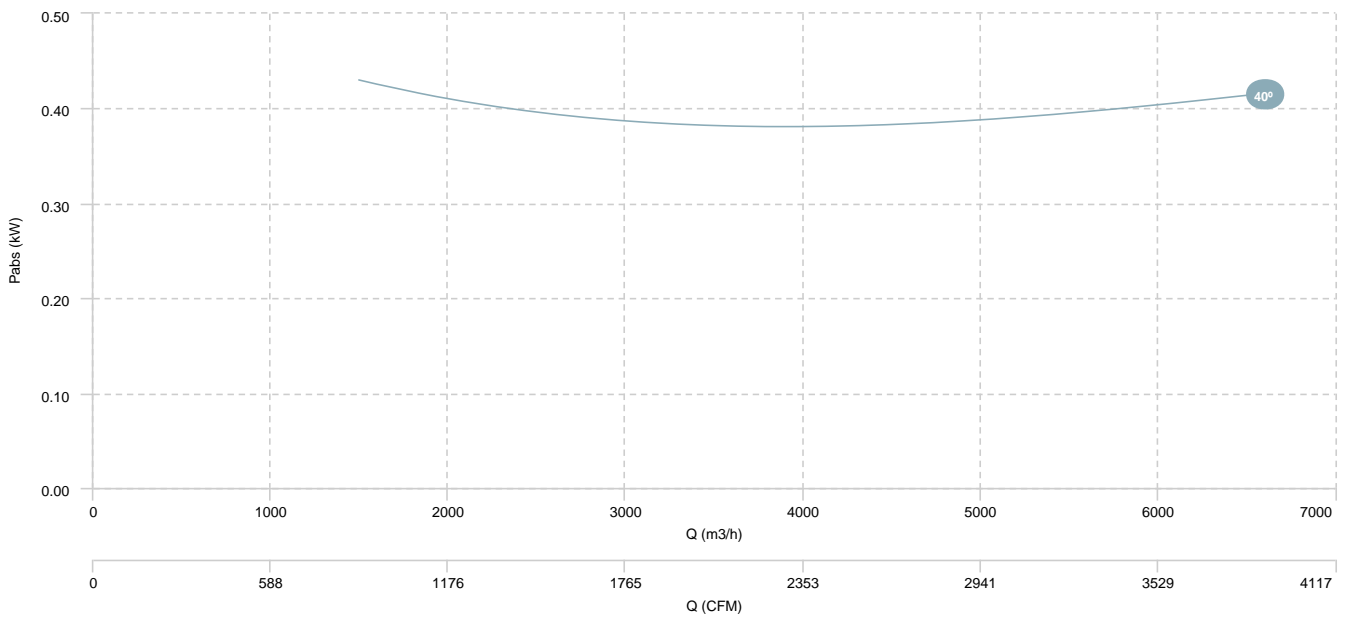



HBA 45 T4/T8 0,33/0,04kW (A0:6)

AIR FLOW - PRESSURE (8 poles)

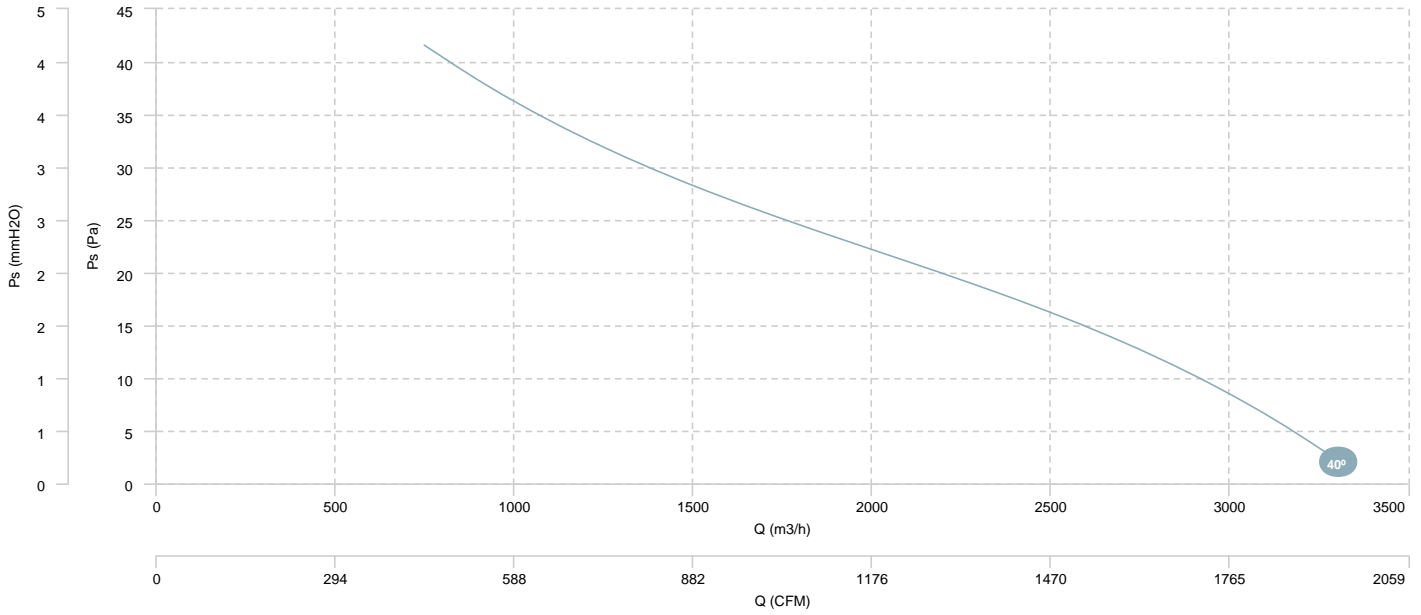

HBA 50 T4 0,55kW (A0:6)

AIR FLOW - PRESSURE

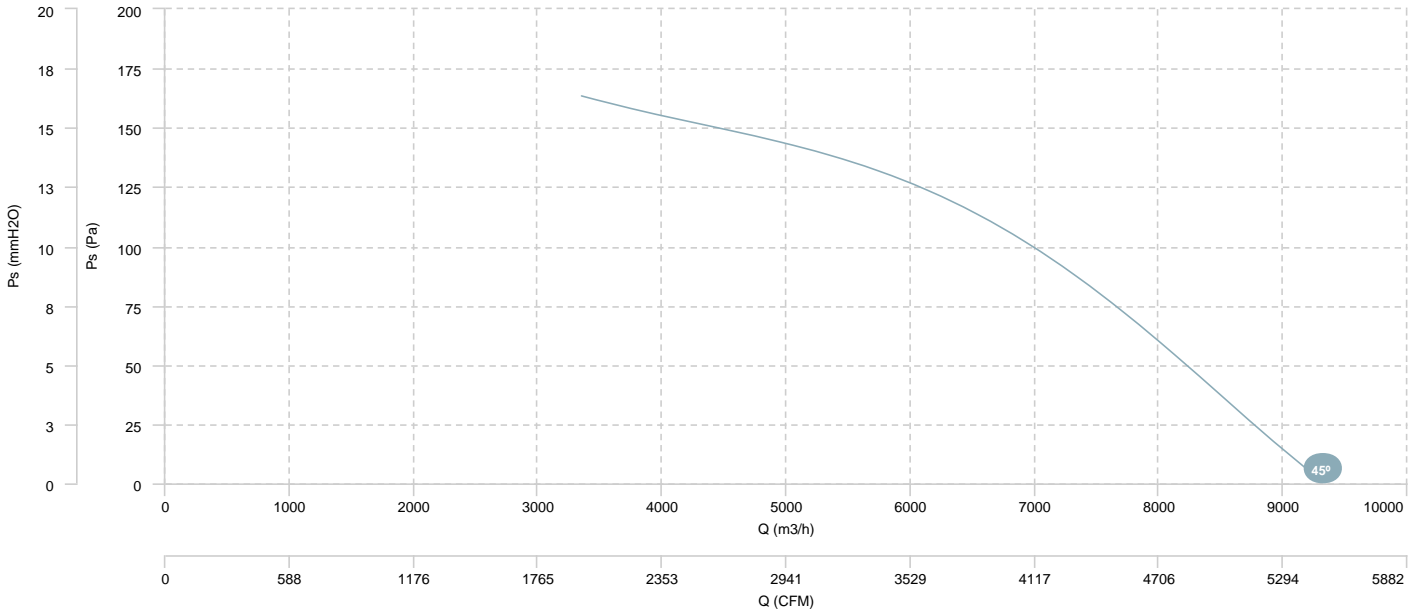

AIR FLOW - ABSORBED POWER

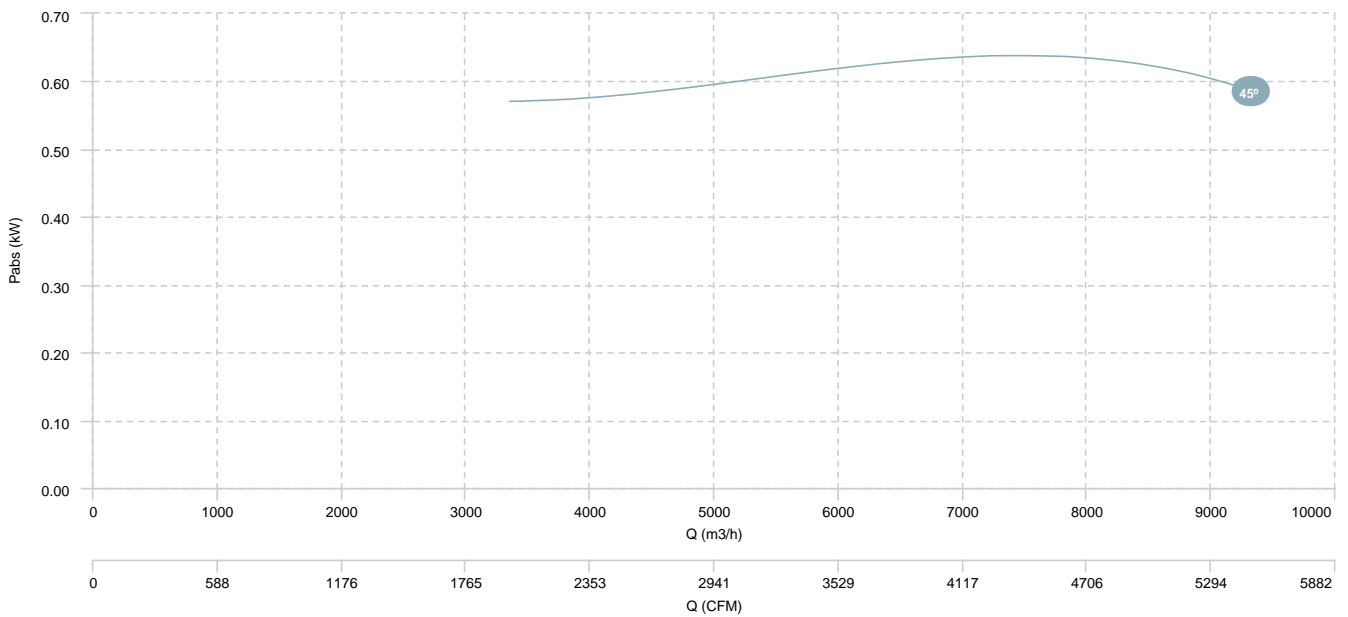

HBA 50 T6 0,13kW (A0:6)

AIR FLOW - PRESSURE

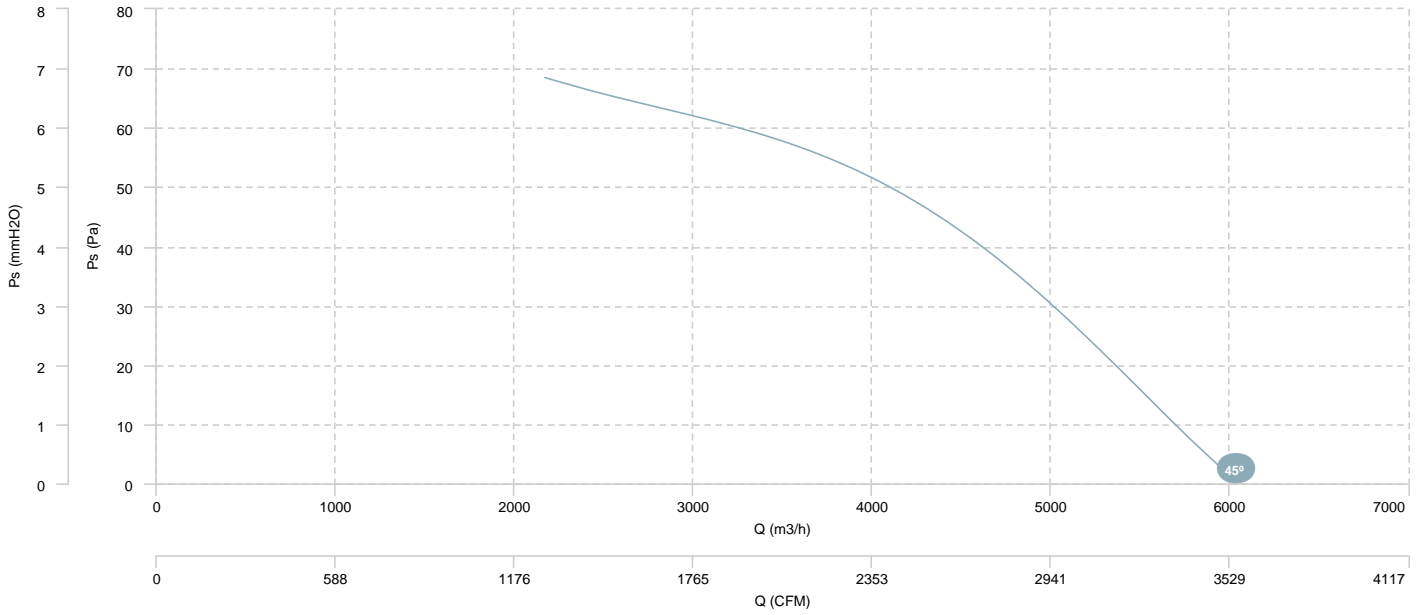

AIR FLOW - ABSORBED POWER

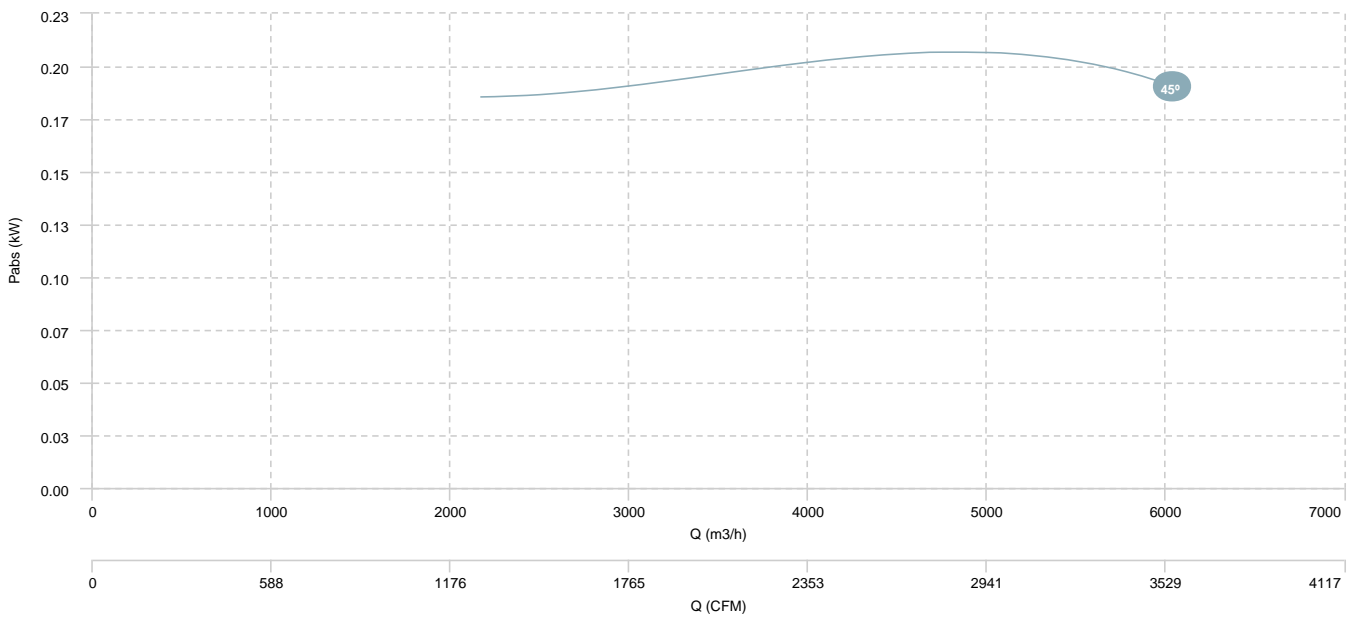

HBA 50 T4/T8 0,55/0,09kW (A0:6)

AIR FLOW - PRESSURE (4 poles)

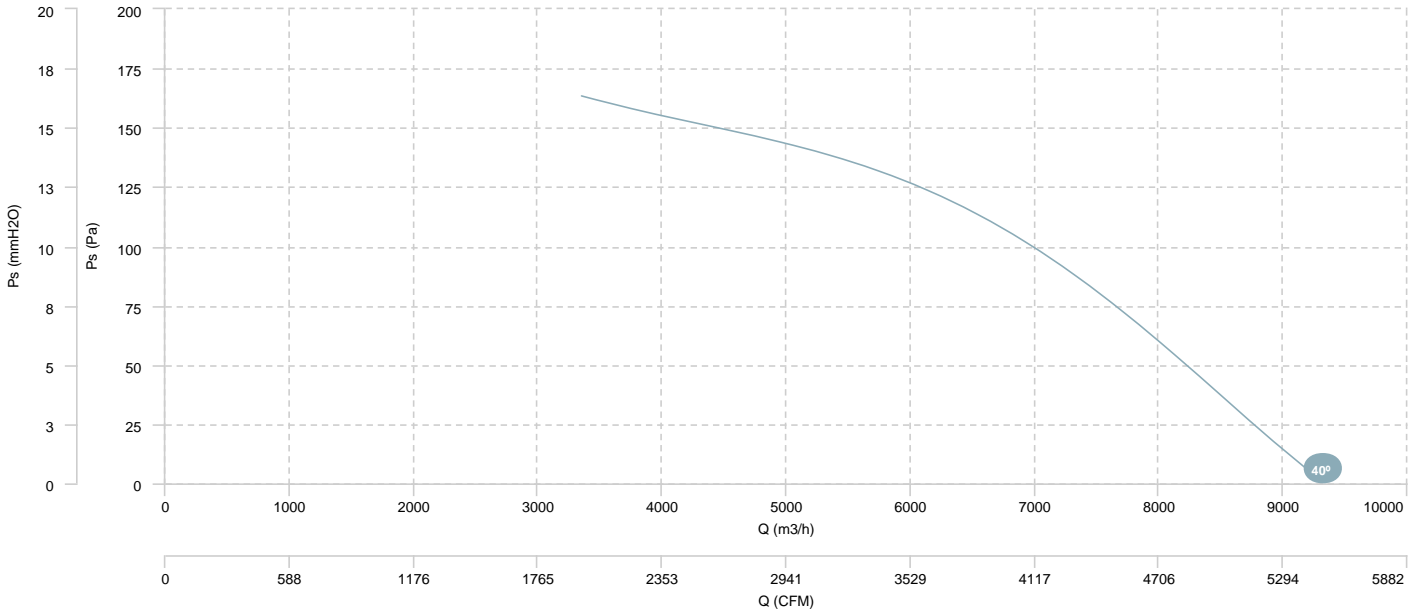

AIR FLOW - ABSORBED POWER (4 poles)

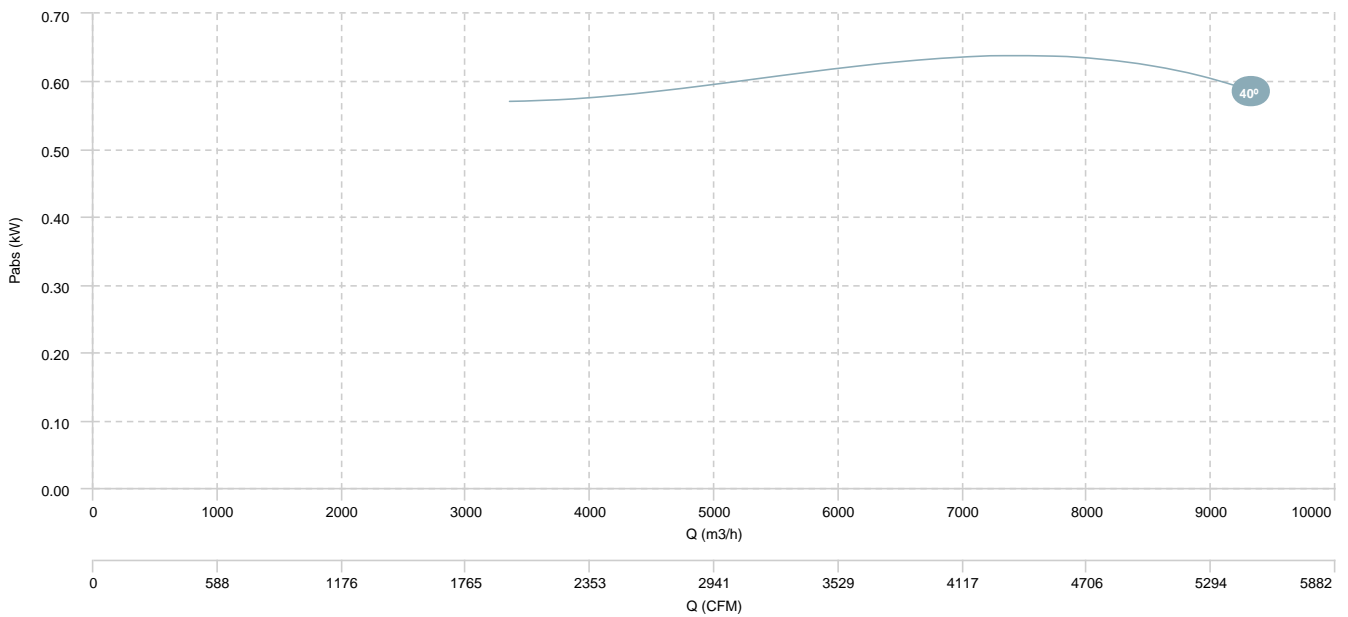

HBA 50 T4/T8 0,55/0,09kW (A0:6)

AIR FLOW - PRESSURE (8 poles)

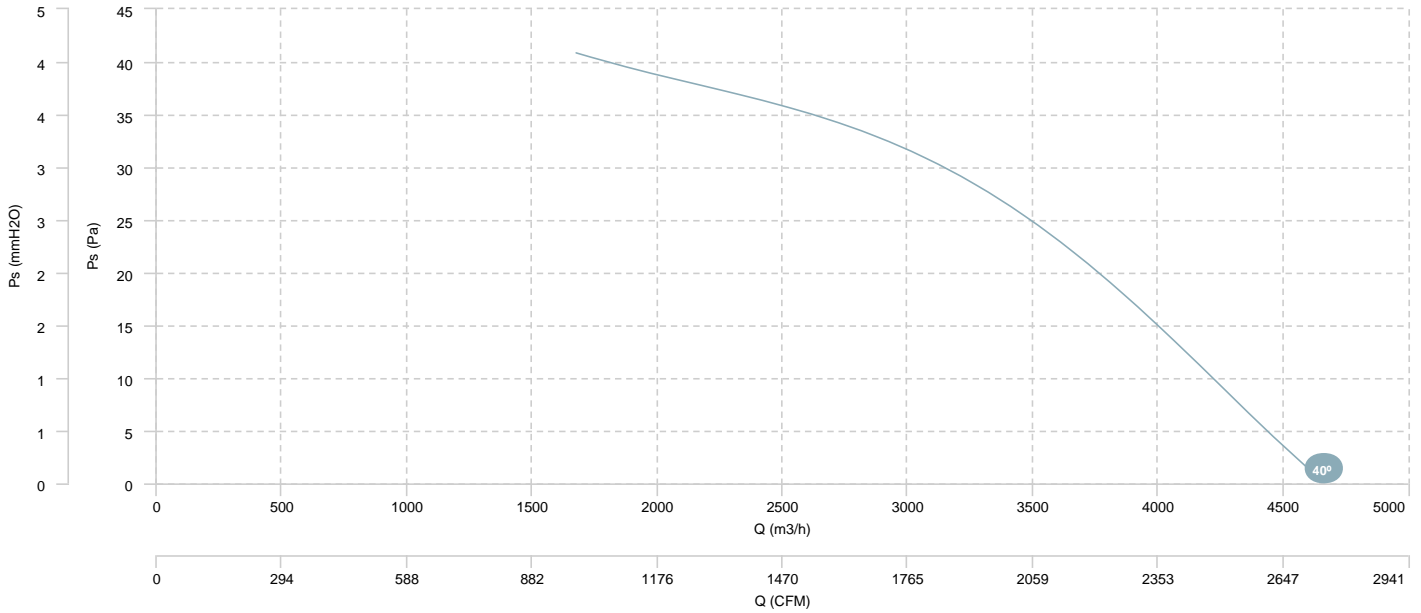

HBA 56 T4 0,55kW (A2:6)	HBA 56 T4 0,75kW (A2:6)	HBA 56 T4 1,1kW (A2:6)
HBA 56 T4 1,5kW (A2:6)		

## AIR FLOW - PRESSURE

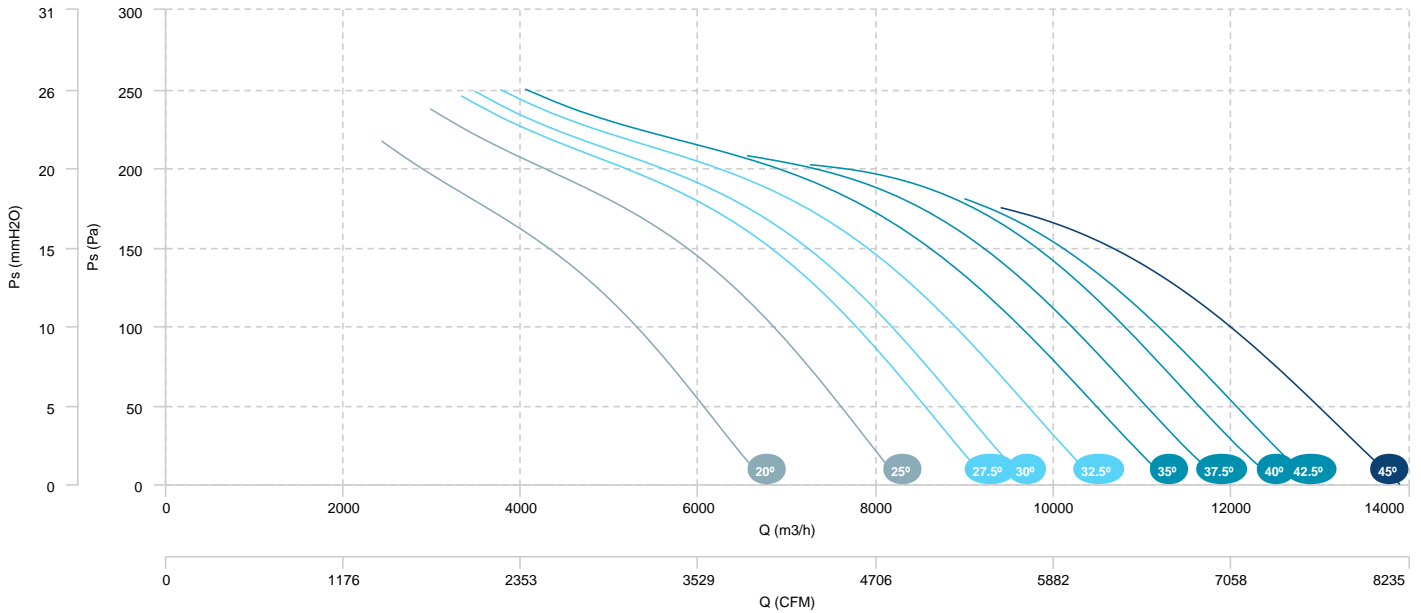

## AIR FLOW - ABSORBED POWER

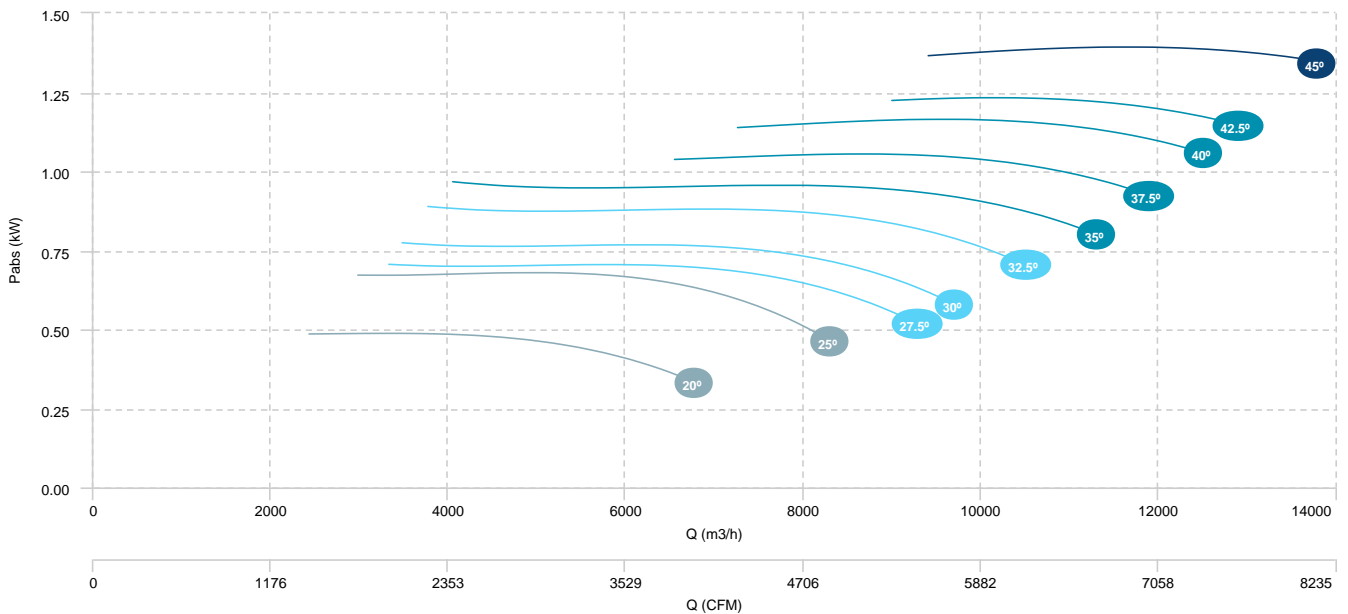

HBA 56 T4 0,55kW (A2:9)

HBA 56 T4 0,75kW (A2:9)

HBA 56 T4 1,1kW (A2:9)

HBA 56 T4 1,5kW (A2:9)

## AIR FLOW - PRESSURE

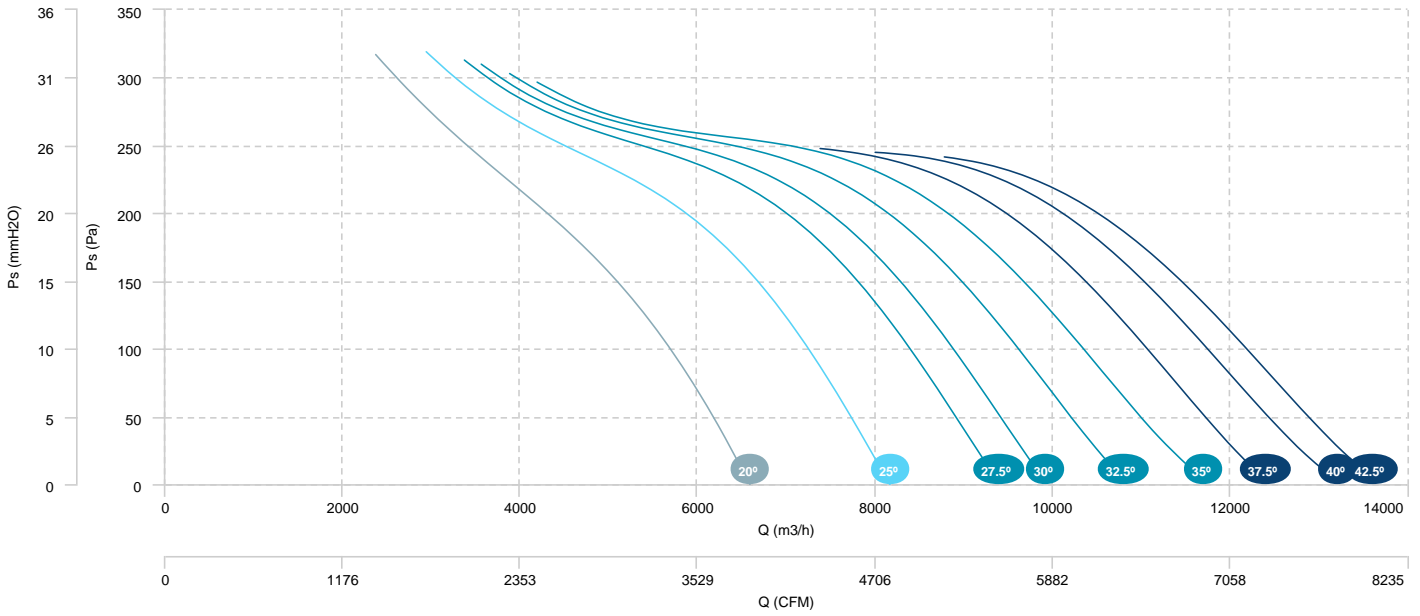

## AIR FLOW - ABSORBED POWER

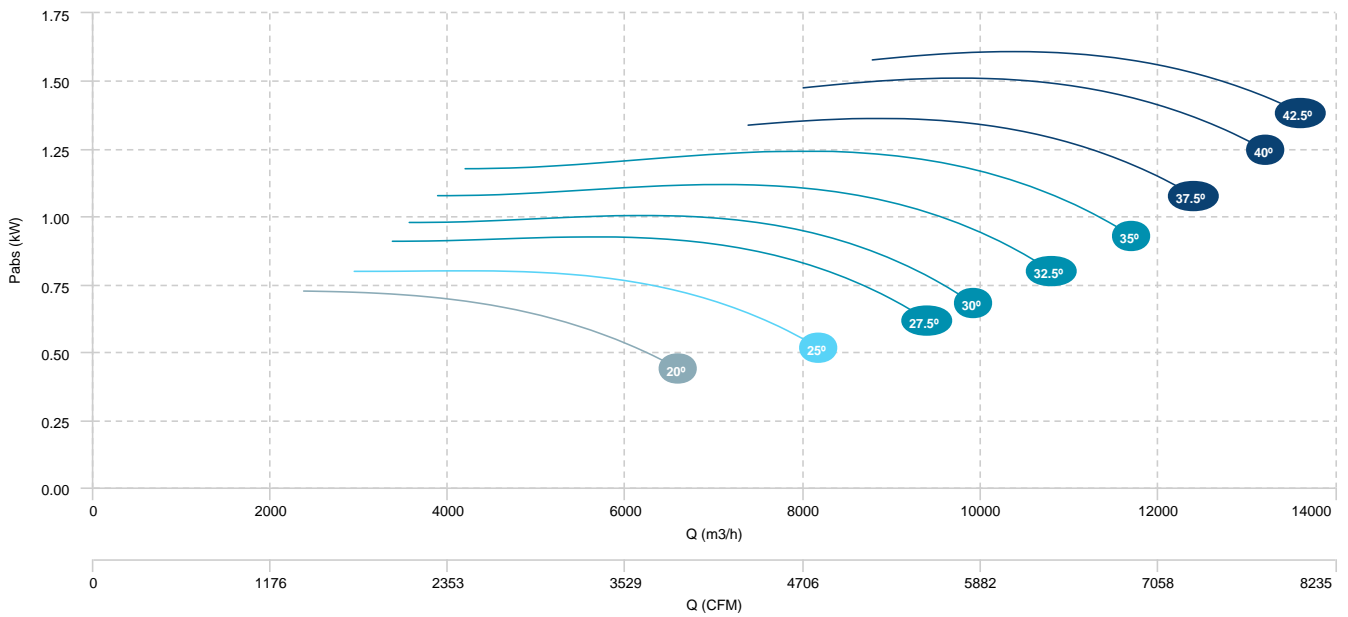

HBA 56 T4 0,37kW (A5:6)	HBA 56 T4 0,55kW (A5:6)	HBA 56 T4 0,75kW (A5:6)
HBA 56 T4 1,1kW (A5:6)	HBA 56 T4 1,5kW (A5:6)	

AIR FLOW - PRESSURE

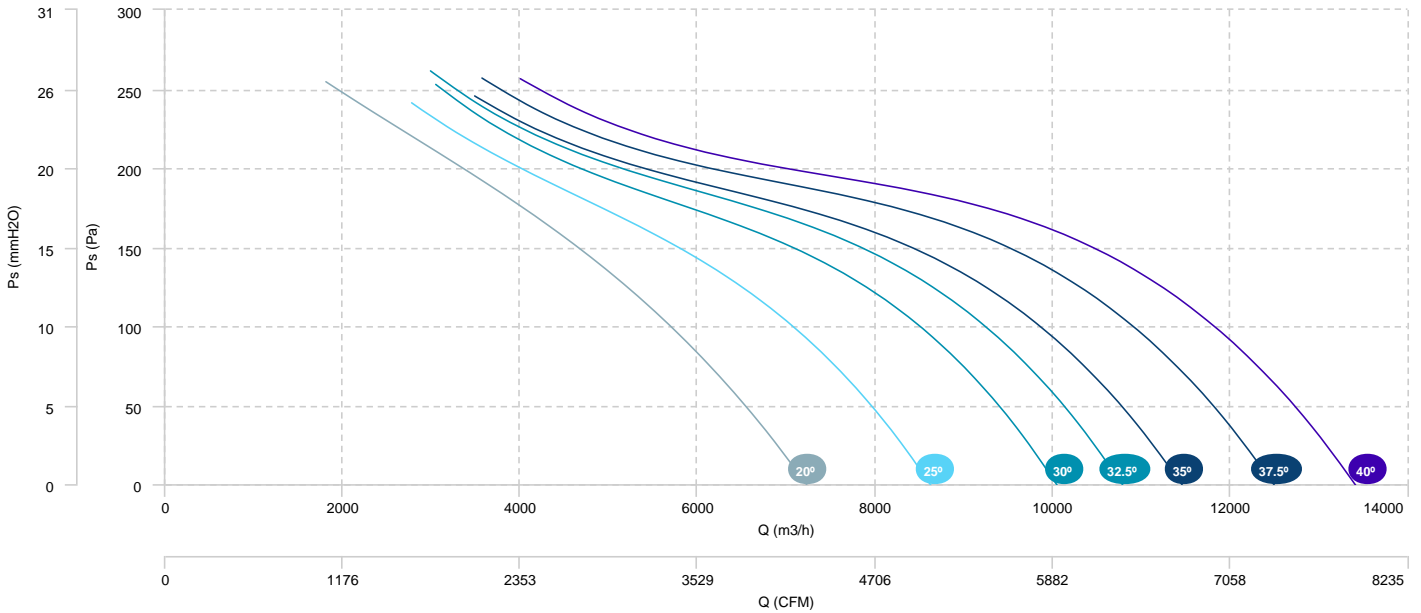

AIR FLOW - ABSORBED POWER

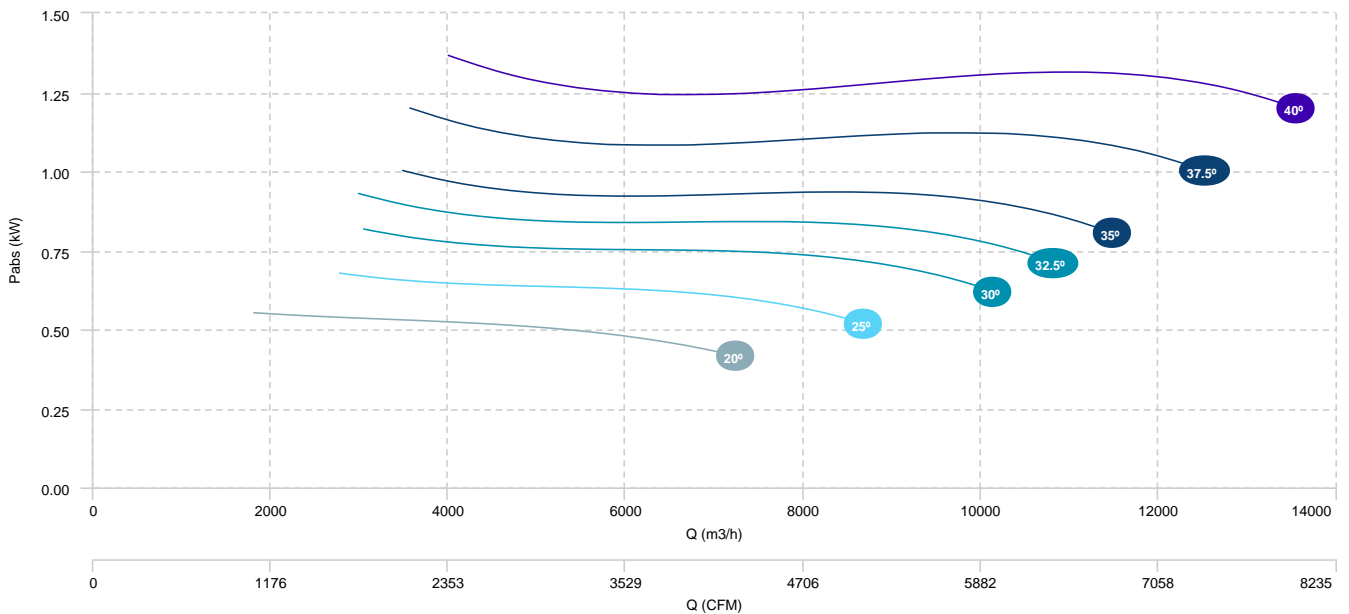



HBA 56 T6 0,55kW (A2:9)

AIR FLOW - PRESSURE

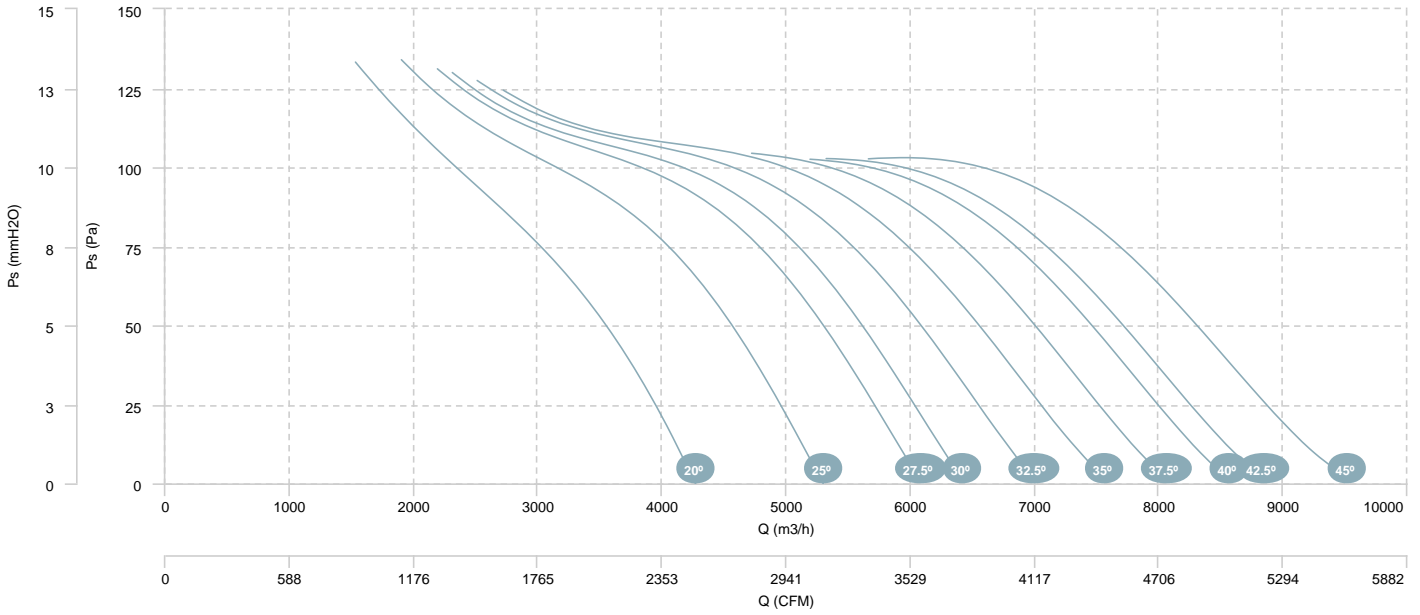

AIR FLOW - ABSORBED POWER

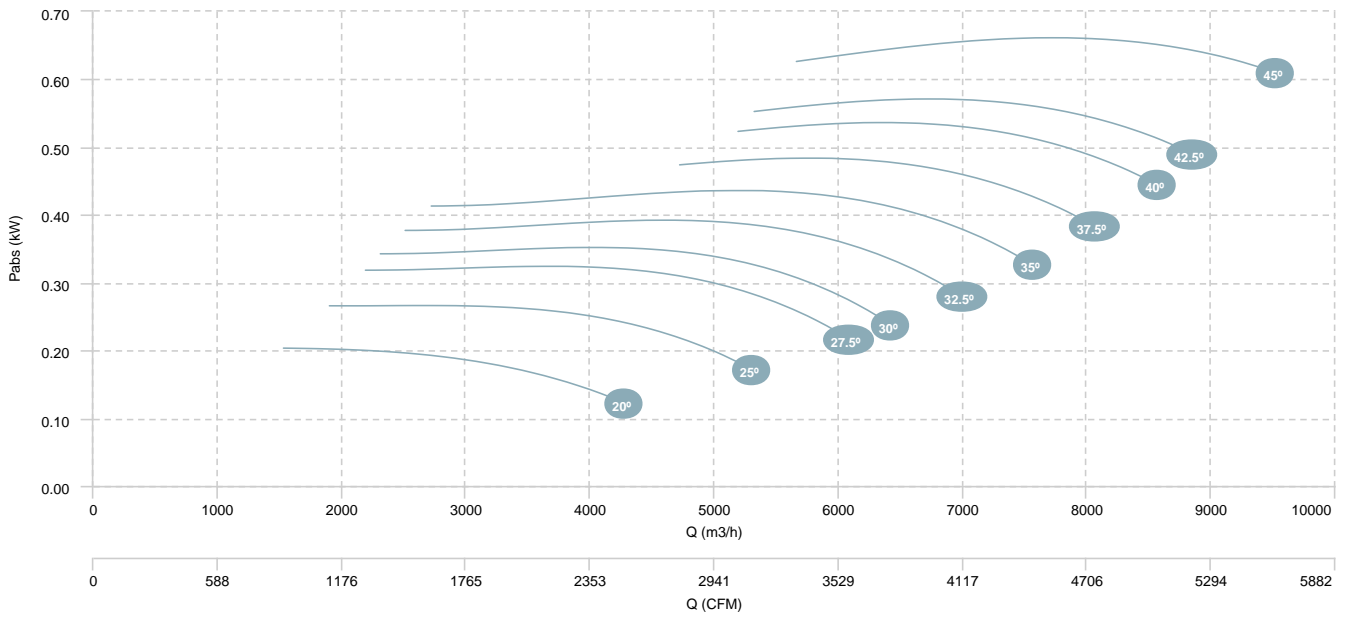

HBA 56 T6 0,25kW (A5:6)

HBA 56 T6 0,37kW (A5:6)

## AIR FLOW - PRESSURE

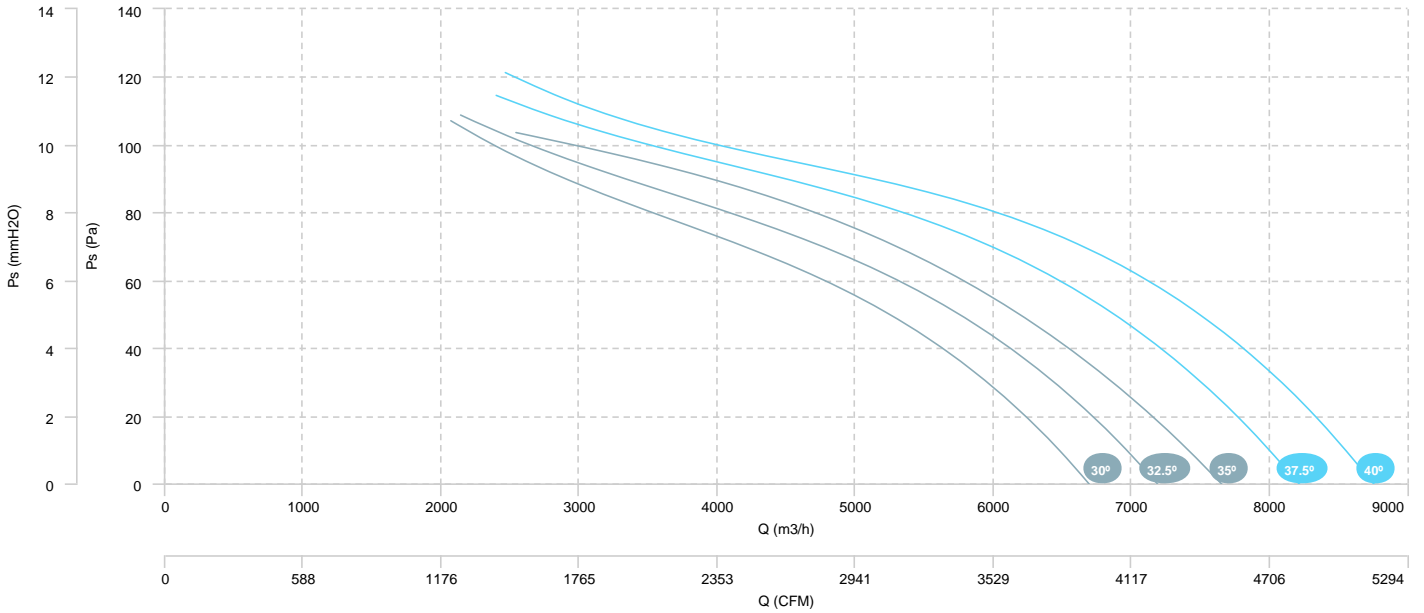

## AIR FLOW - ABSORBED POWER

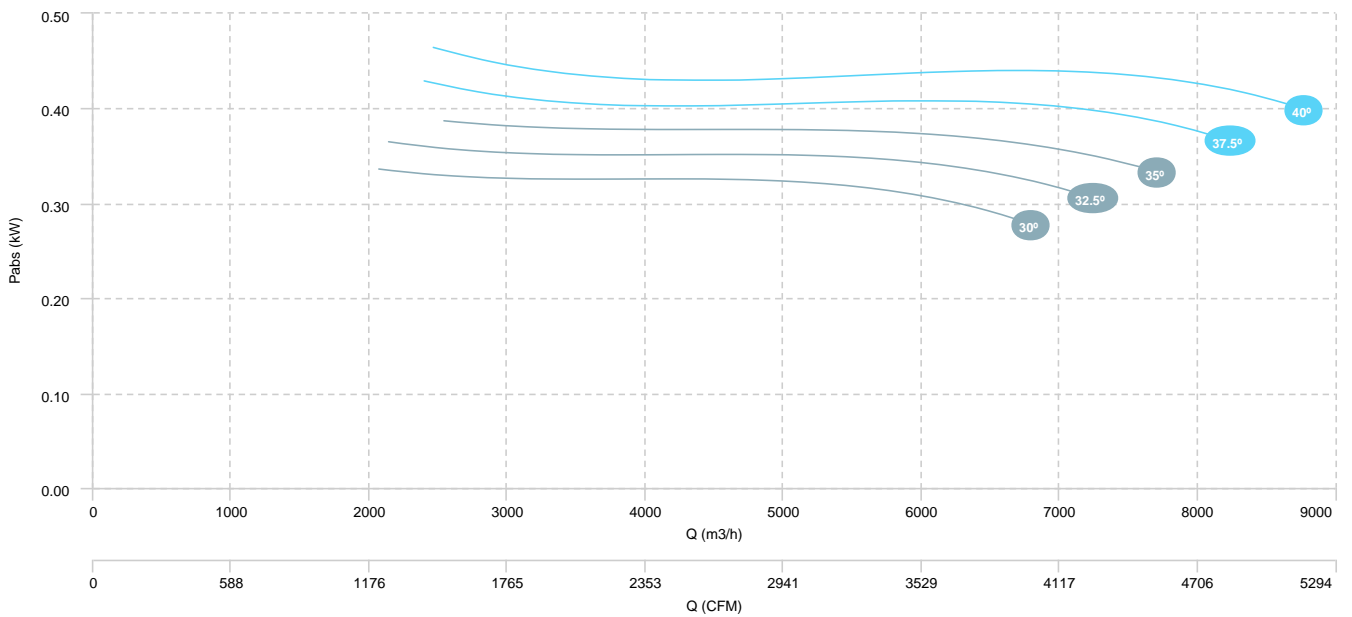

HBA 56 T6 0,55kW (A2:6)

## AIR FLOW - PRESSURE

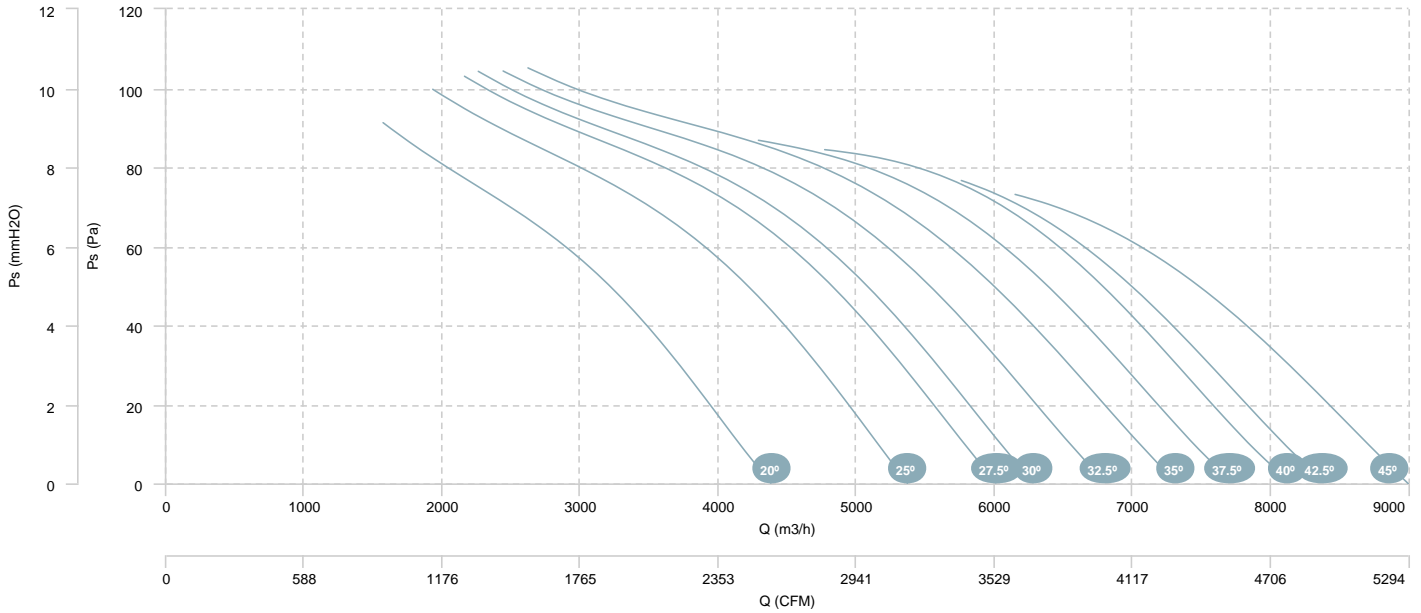

## AIR FLOW - ABSORBED POWER



HBA 56 T4/T8 0,55/0,09kW (A2:9)

HBA 56 T4/T8 0,75/0,12kW (A2:9)

HBA 56 T4/T8 1,1/0,18kW (A2:9)

HBA 56 T4/T8 1,5/0,25kW (A2:9)

## AIR FLOW - PRESSURE (4 poles)

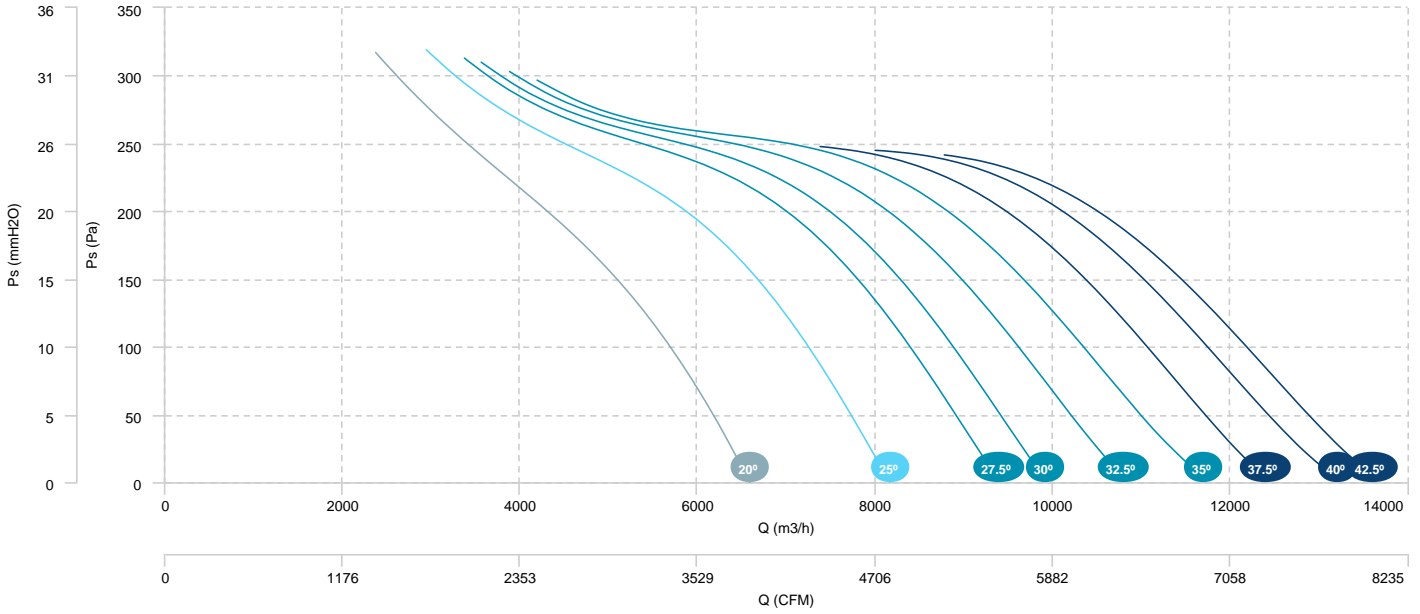

## AIR FLOW - ABSORBED POWER (4 poles)

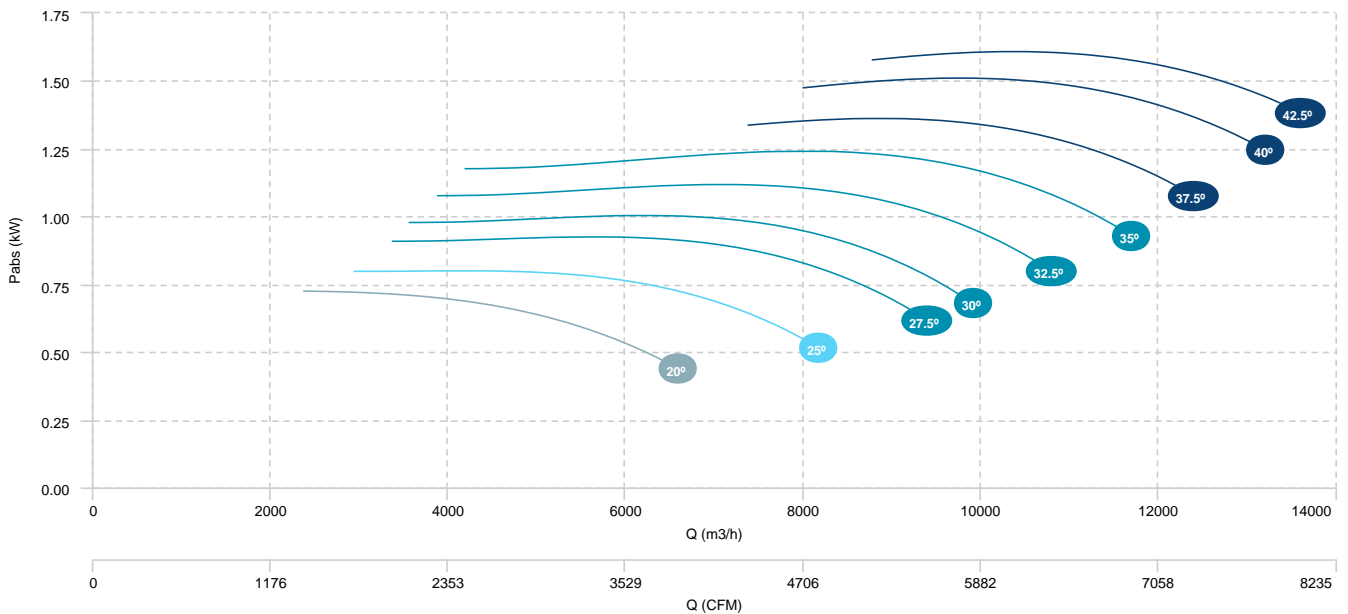

HBA 56 T4/T8 0,55/0,09kW (A2:9)

HBA 56 T4/T8 0,75/0,12kW (A2:9)

HBA 56 T4/T8 1,1/0,18kW (A2:9)

HBA 56 T4/T8 1,5/0,25kW (A2:9)

AIR FLOW - PRESSURE (8 poles)

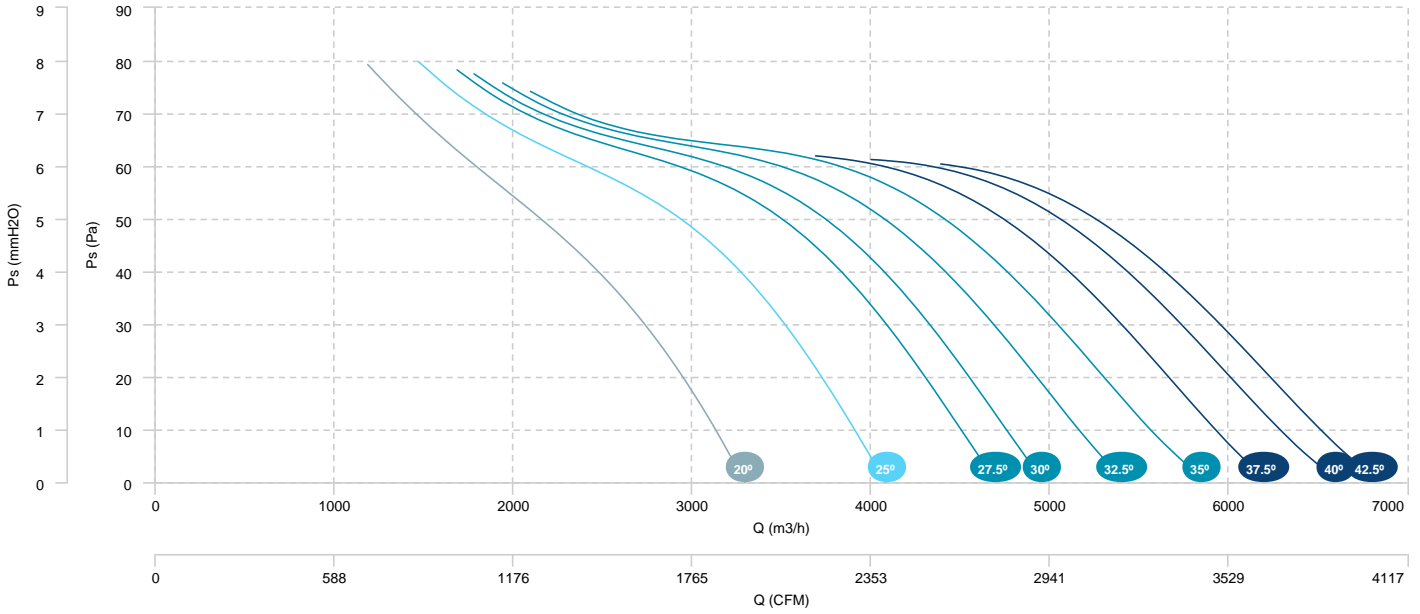

HBA 56 T4/T8 0,33/0,04kW (A5:6)	HBA 56 T4/T8 0,55/0,09kW (A5:6)	HBA 56 T4/T8 0,75/0,12kW (A5:6)
HBA 56 T4/T8 1,1/0,18kW (A5:6)	HBA 56 T4/T8 1,5/0,25kW (A5:6)	

## AIR FLOW - PRESSURE (4 poles)

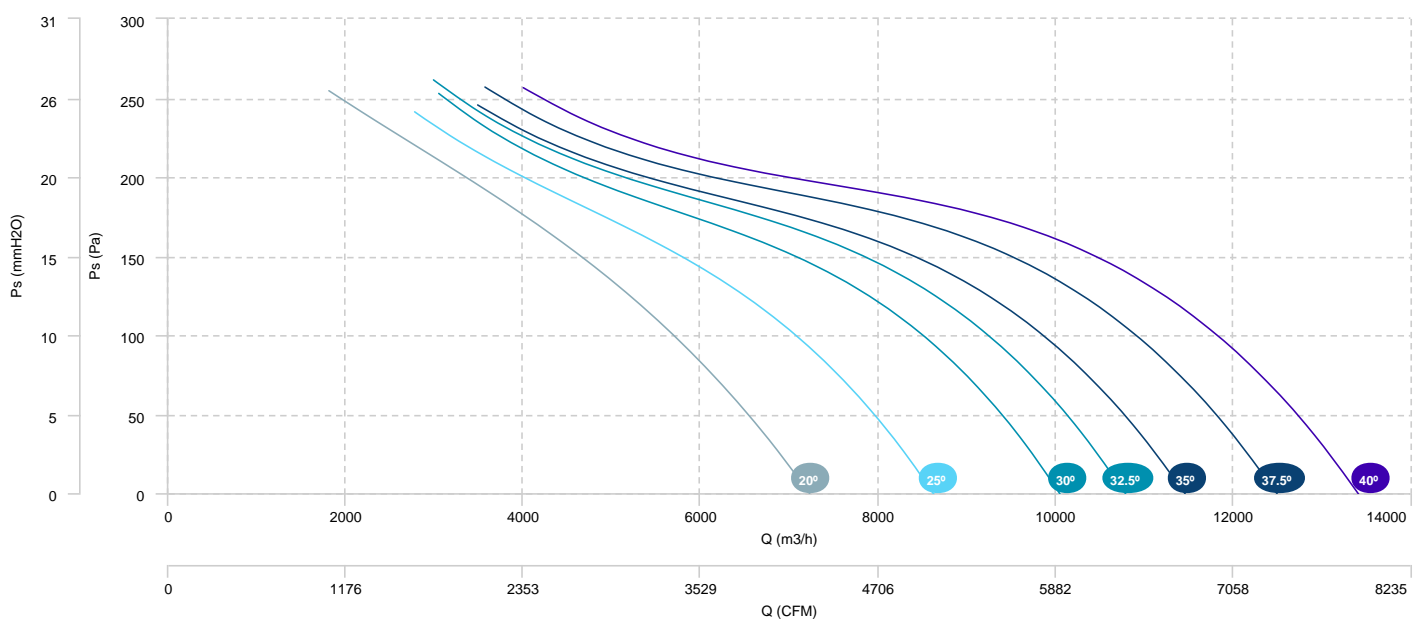

## AIR FLOW - ABSORBED POWER (4 poles)

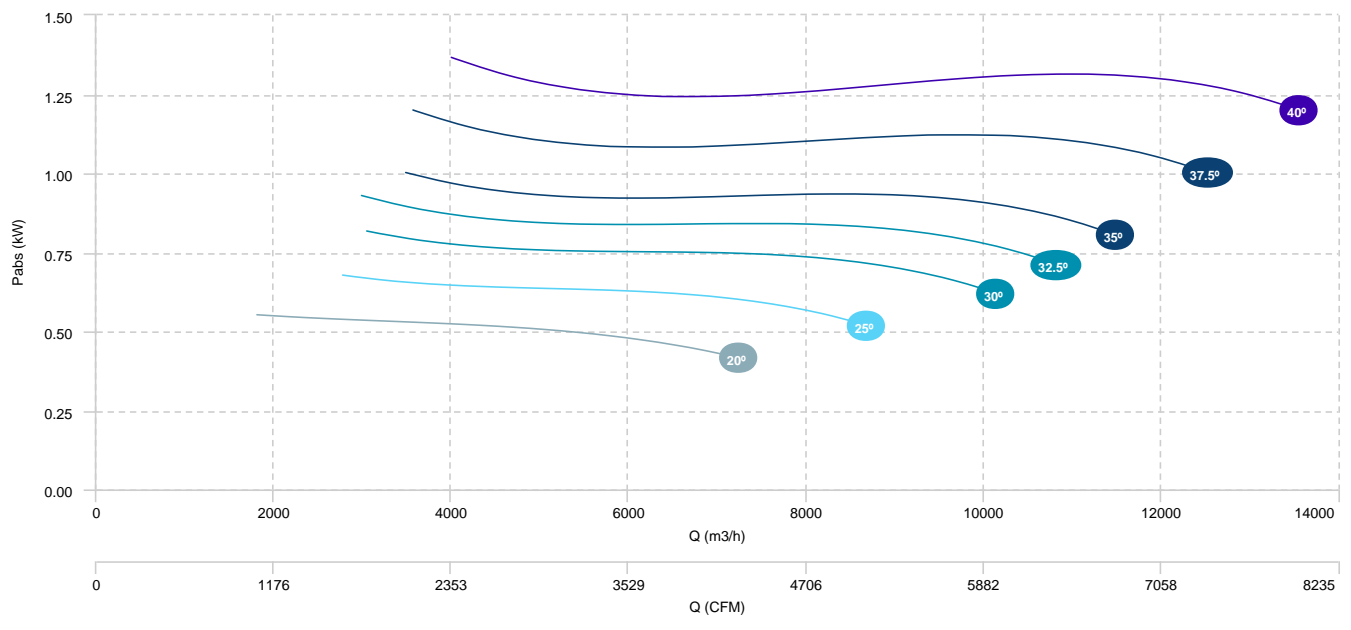

HBA 56 T4/T8 0,33/0,04kW (A5:6)	HBA 56 T4/T8 0,55/0,09kW (A5:6)	HBA 56 T4/T8 0,75/0,12kW (A5:6)
HBA 56 T4/T8 1,1/0,18kW (A5:6)	HBA 56 T4/T8 1,5/0,25kW (A5:6)	

## AIR FLOW - PRESSURE (8 poles)

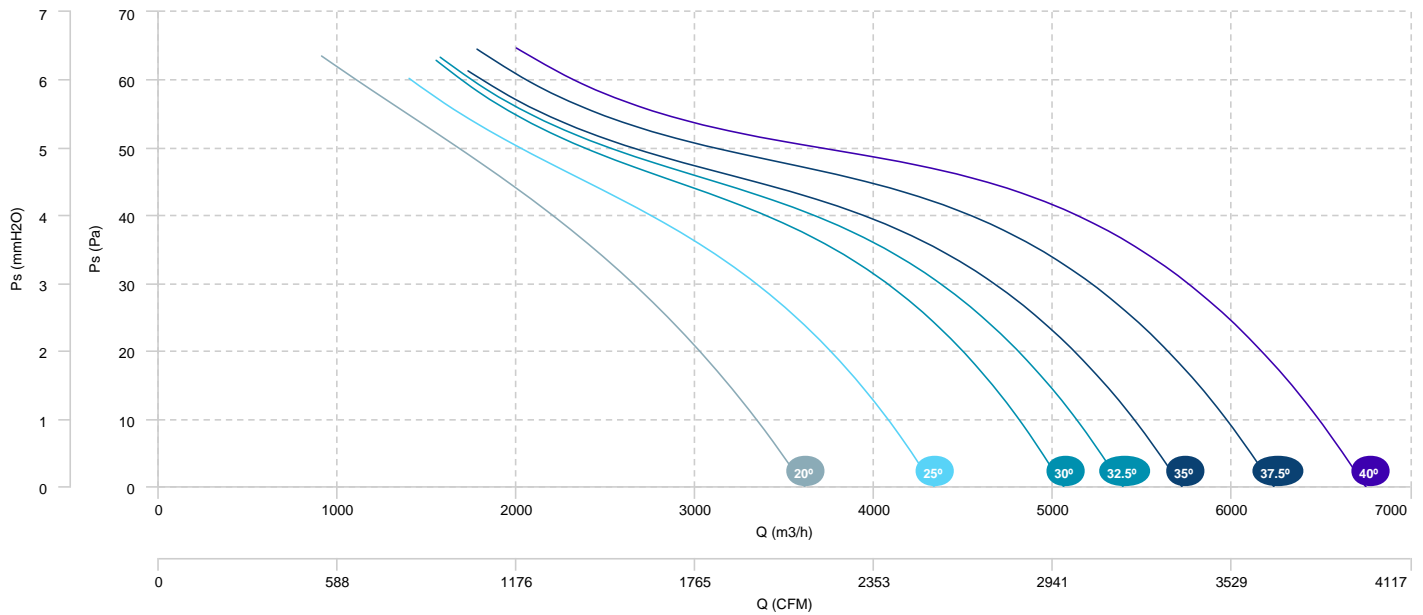

HBA 56 T4/T8 0,55/0,09kW (A2:6)	HBA 56 T4/T8 0,75/0,12kW (A2:6)	HBA 56 T4/T8 1,1/0,18kW (A2:6)
HBA 56 T4/T8 1,5/0,25kW (A2:6)		

## AIR FLOW - PRESSURE (4 poles)

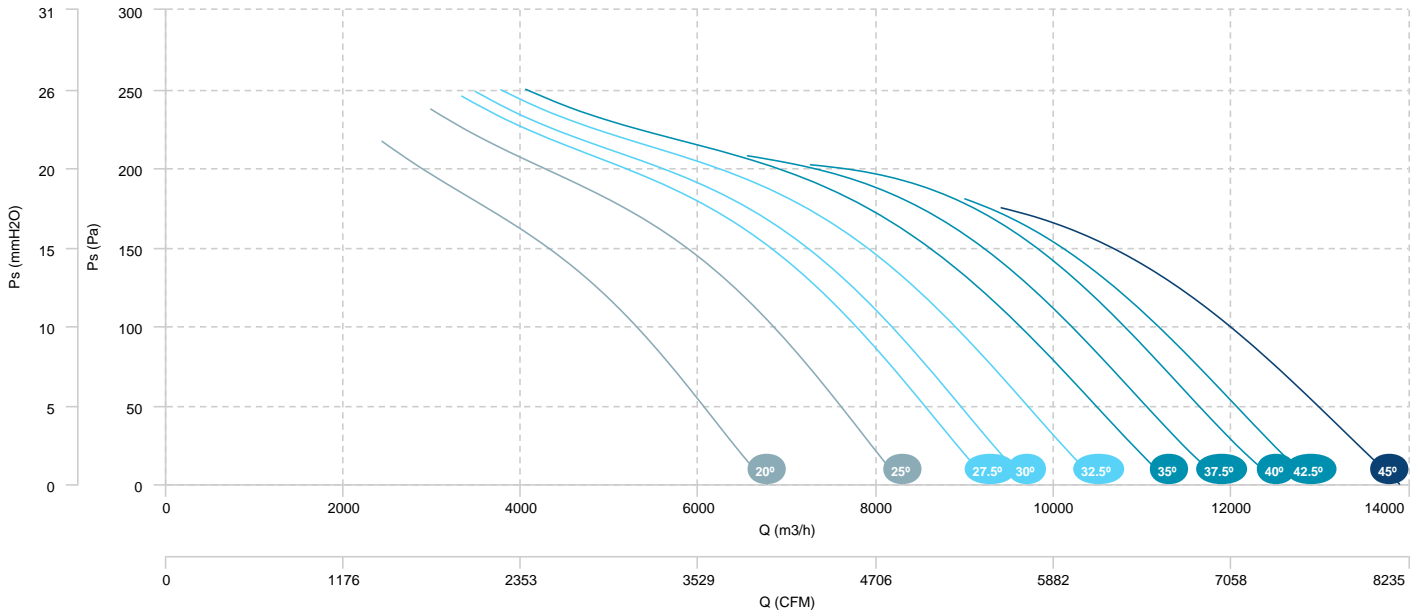

## AIR FLOW - ABSORBED POWER (4 poles)

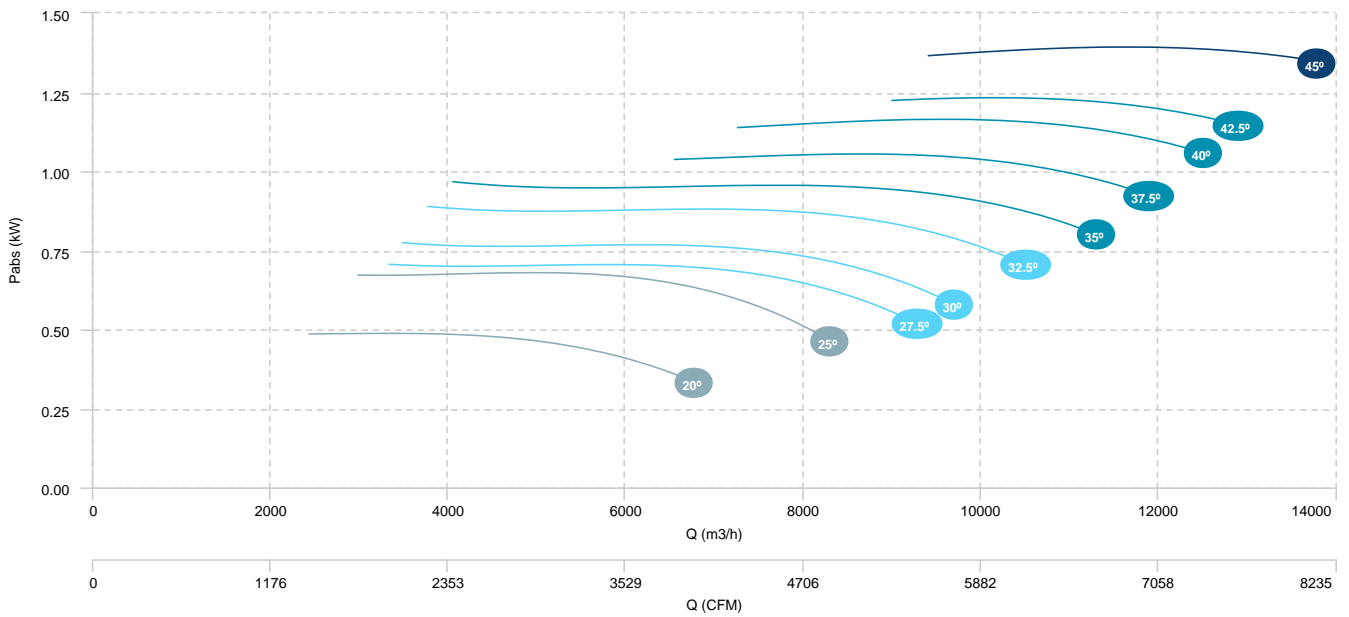



HBA 56 T4/T8 0,55/0,09kW (A2:6)	HBA 56 T4/T8 0,75/0,12kW (A2:6)	HBA 56 T4/T8 1,1/0,18kW (A2:6)
HBA 56 T4/T8 1,5/0,25kW (A2:6)		

## AIR FLOW - PRESSURE (8 poles)

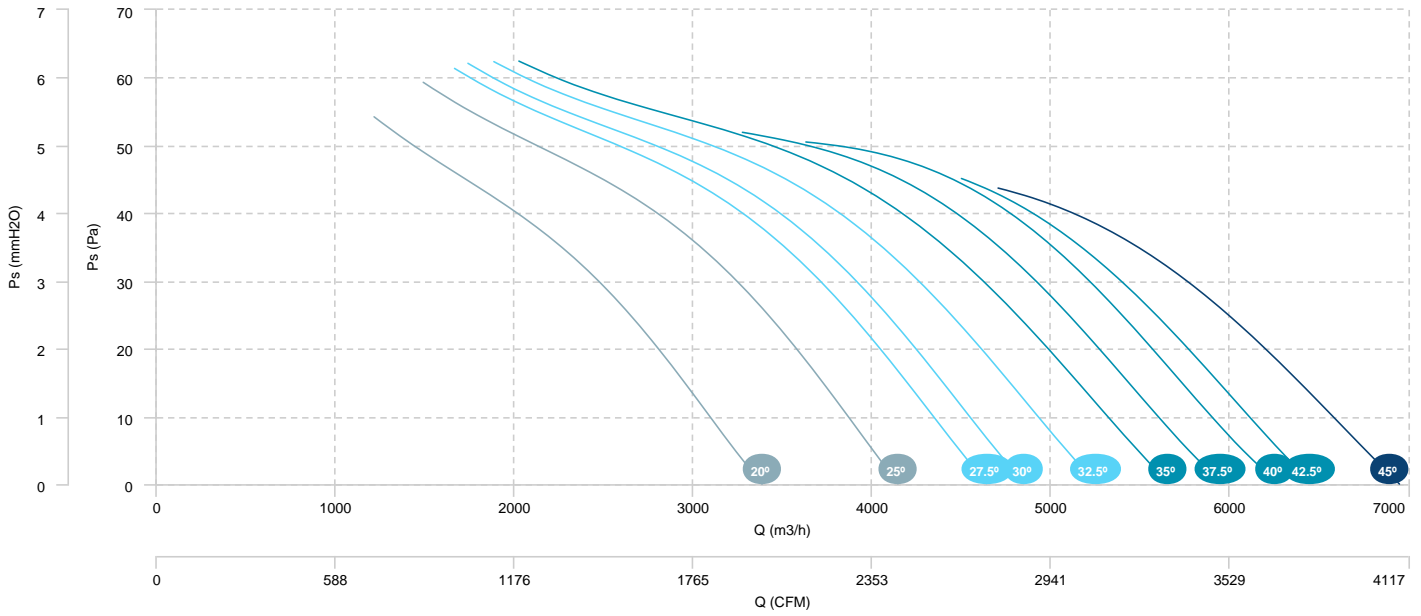

HBA 63 T4 0,75kW (A2:9)	HBA 63 T4 1,1kW (A2:9)	HBA 63 T4 1,5kW (A2:9)
HBA 63 T4 2,2kW (A2:9)	HBA 63 T4 3kW (A2:9)	

## AIR FLOW - PRESSURE

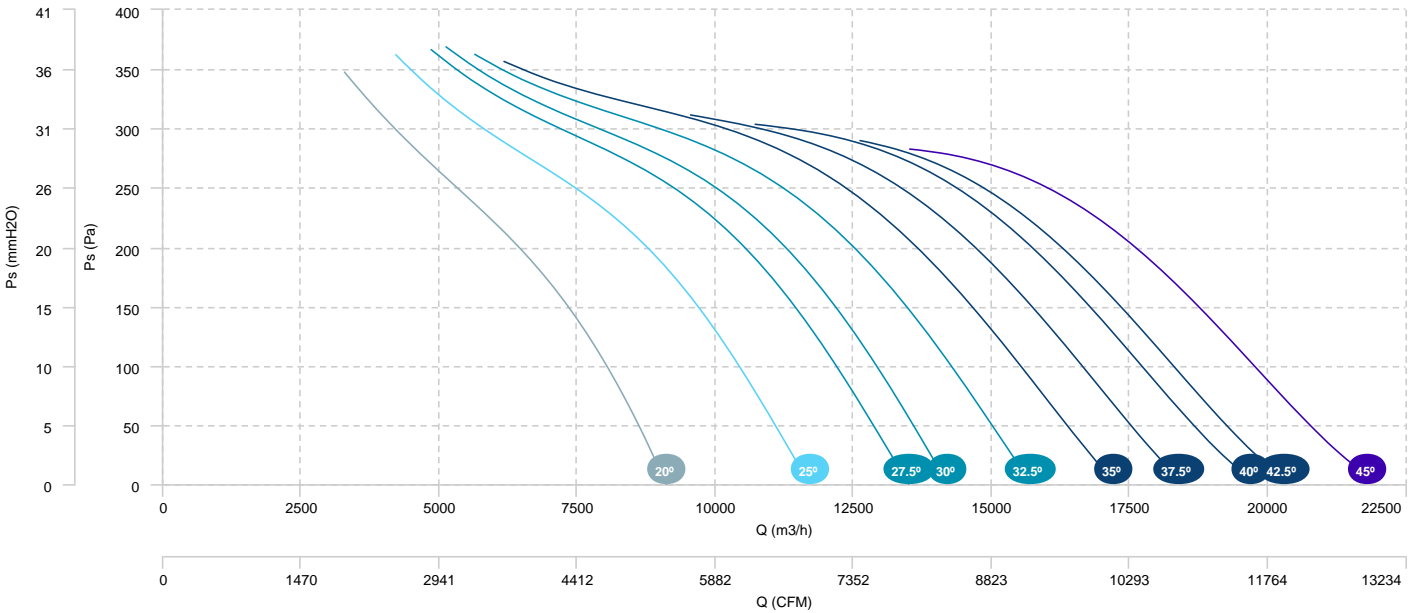

## AIR FLOW - ABSORBED POWER

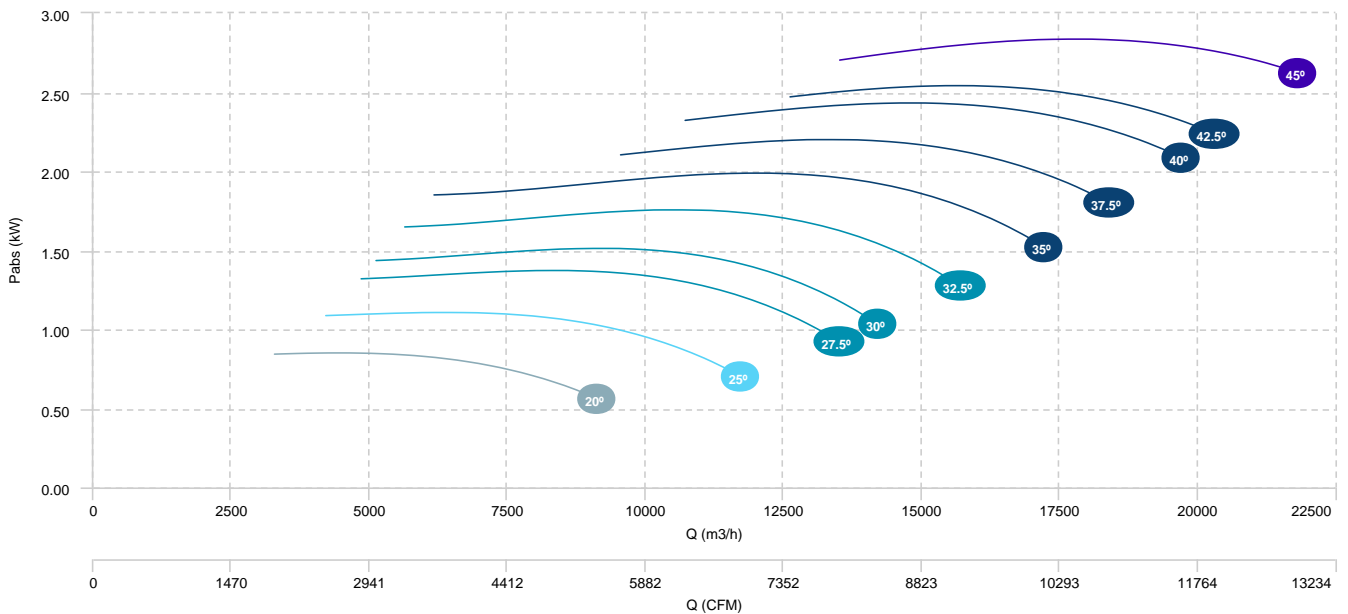

HBA 63 T4 0,75kW (A5:6)

HBA 63 T4 1,1kW (A5:6)

HBA 63 T4 1,5kW (A5:6)

HBA 63 T4 2,2kW (A5:6)

## AIR FLOW - PRESSURE

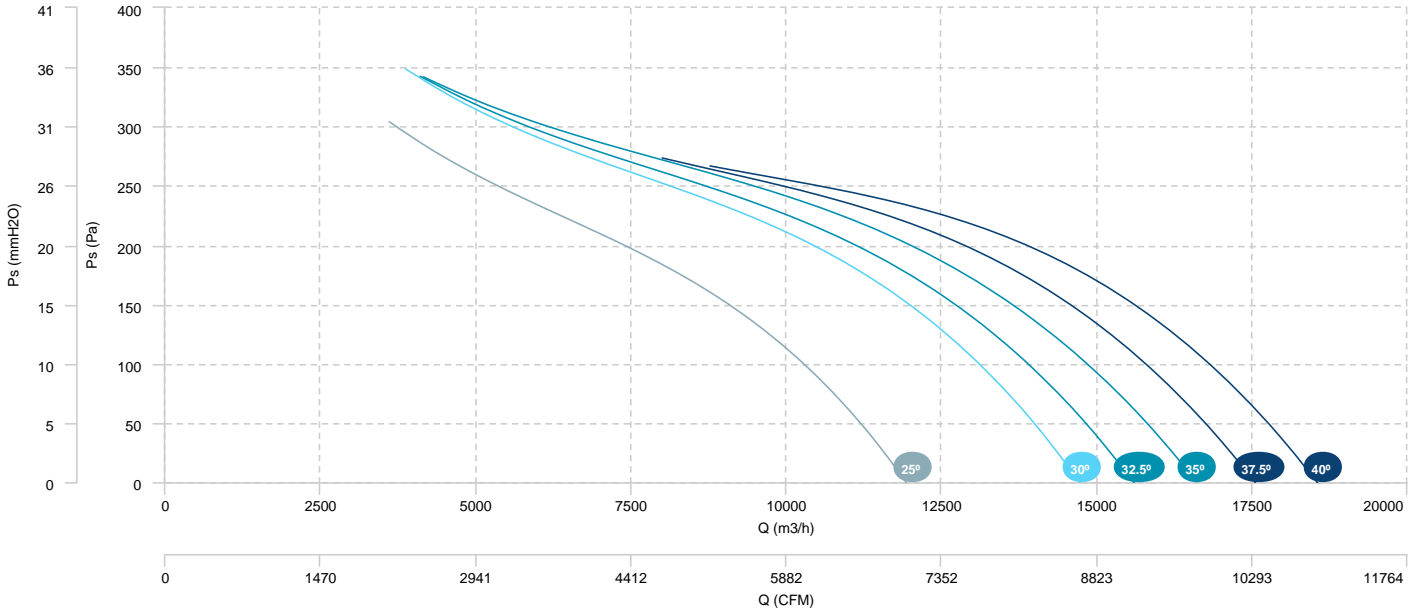

## AIR FLOW - ABSORBED POWER

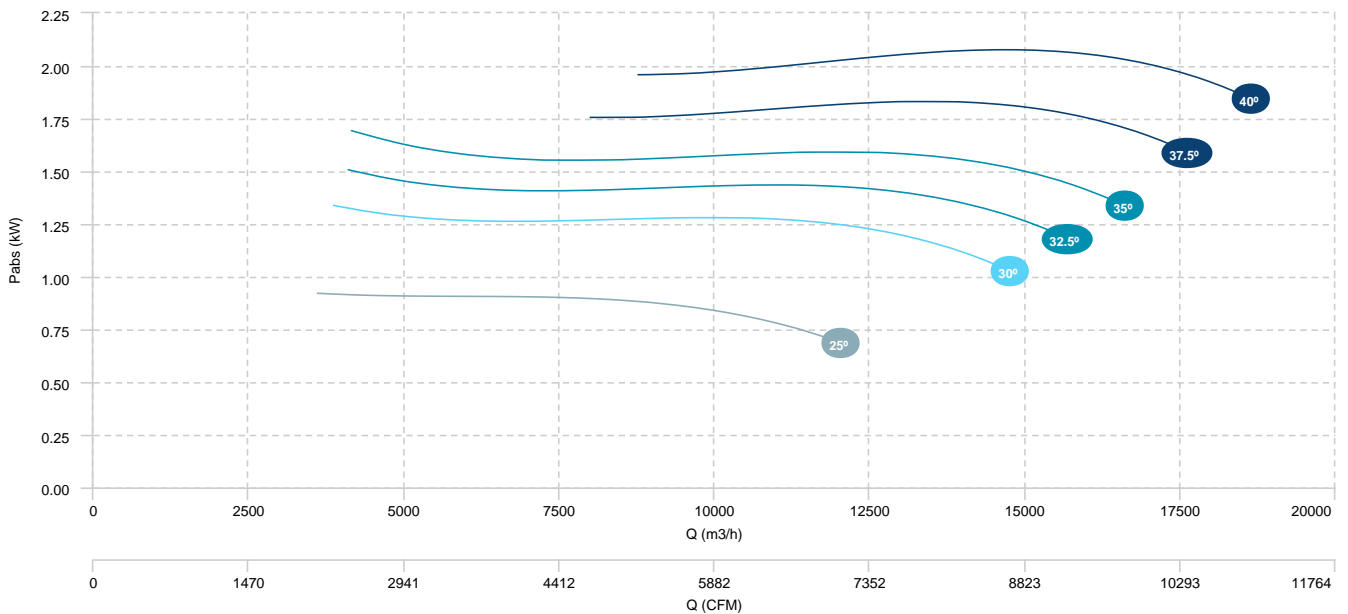

HBA 63 T4 0,55kW (A2:6)	HBA 63 T4 0,75kW (A2:6)	HBA 63 T4 1,1kW (A2:6)
HBA 63 T4 1,5kW (A2:6)	HBA 63 T4 2,2kW (A2:6)	

## AIR FLOW - PRESSURE

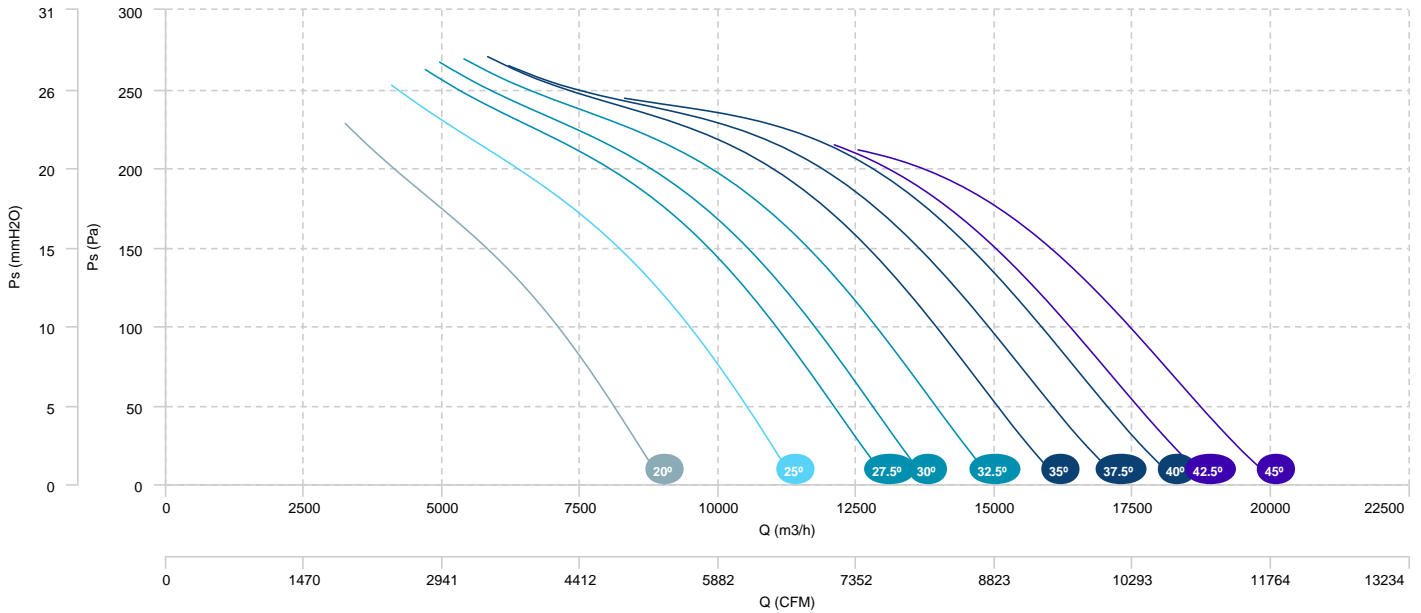

## AIR FLOW - ABSORBED POWER

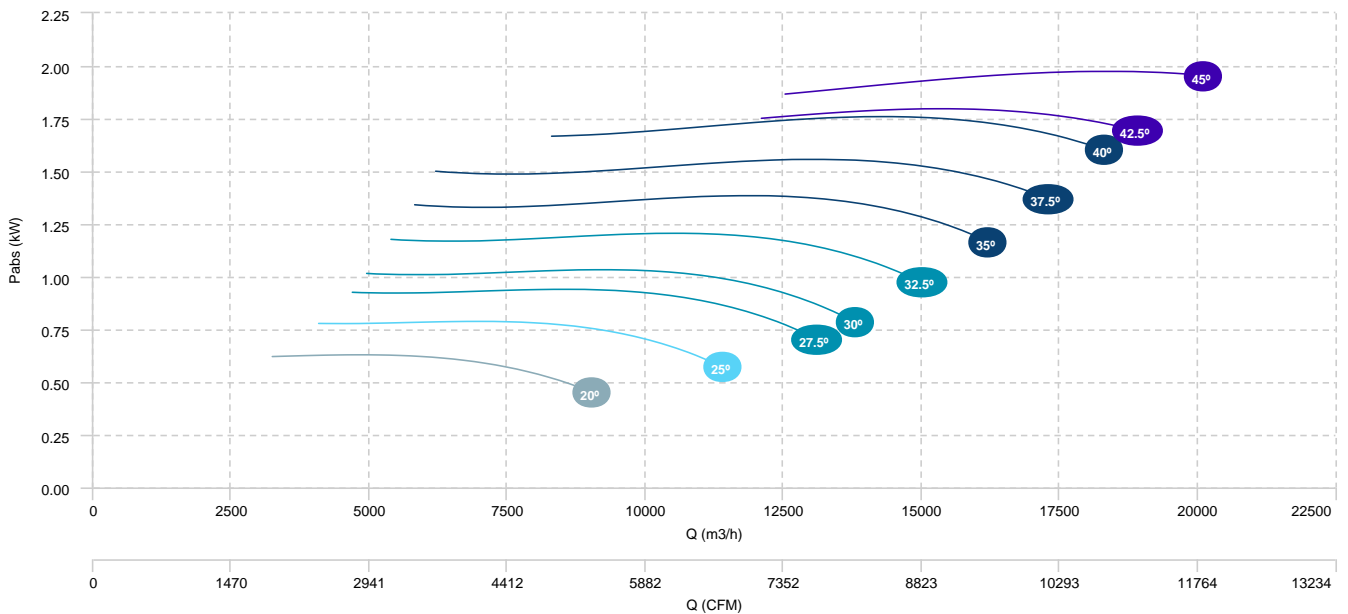

HBA 63 T6 0,55KW (A2:6)

AIR FLOW - PRESSURE

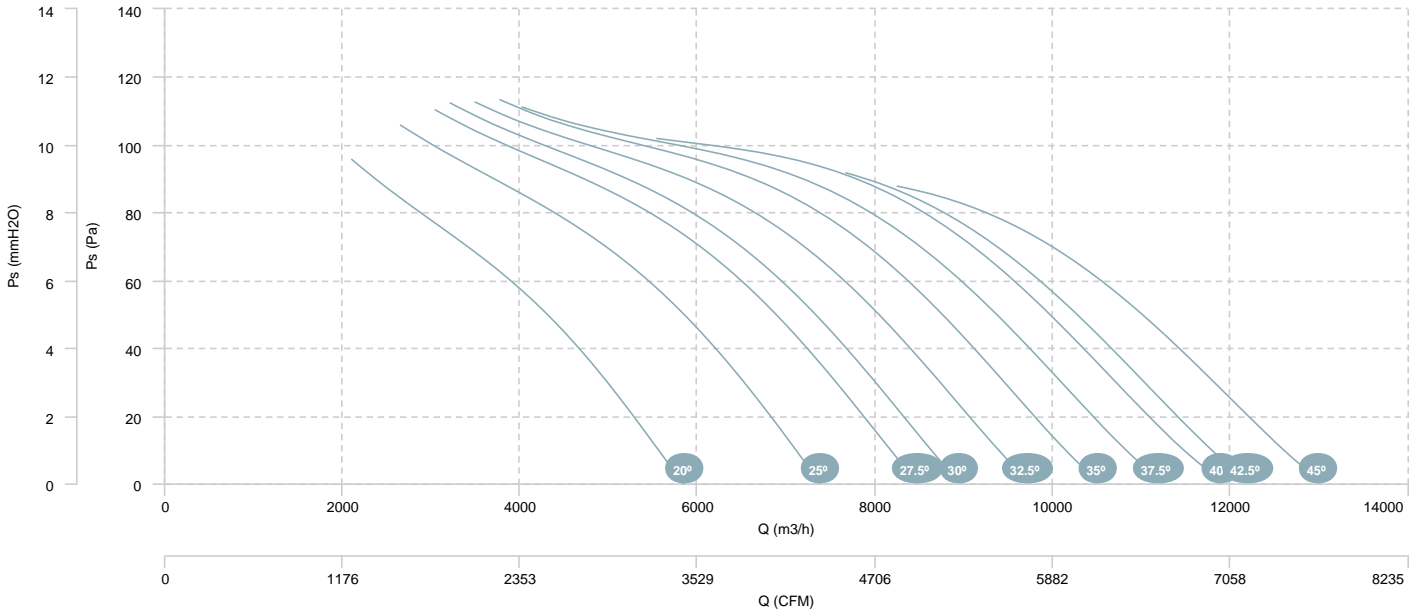

AIR FLOW - ABSORBED POWER



HBA 63 T6 0,37kW (A5:6)

HBA 63 T6 0,55kW (A5:6)

AIR FLOW - PRESSURE

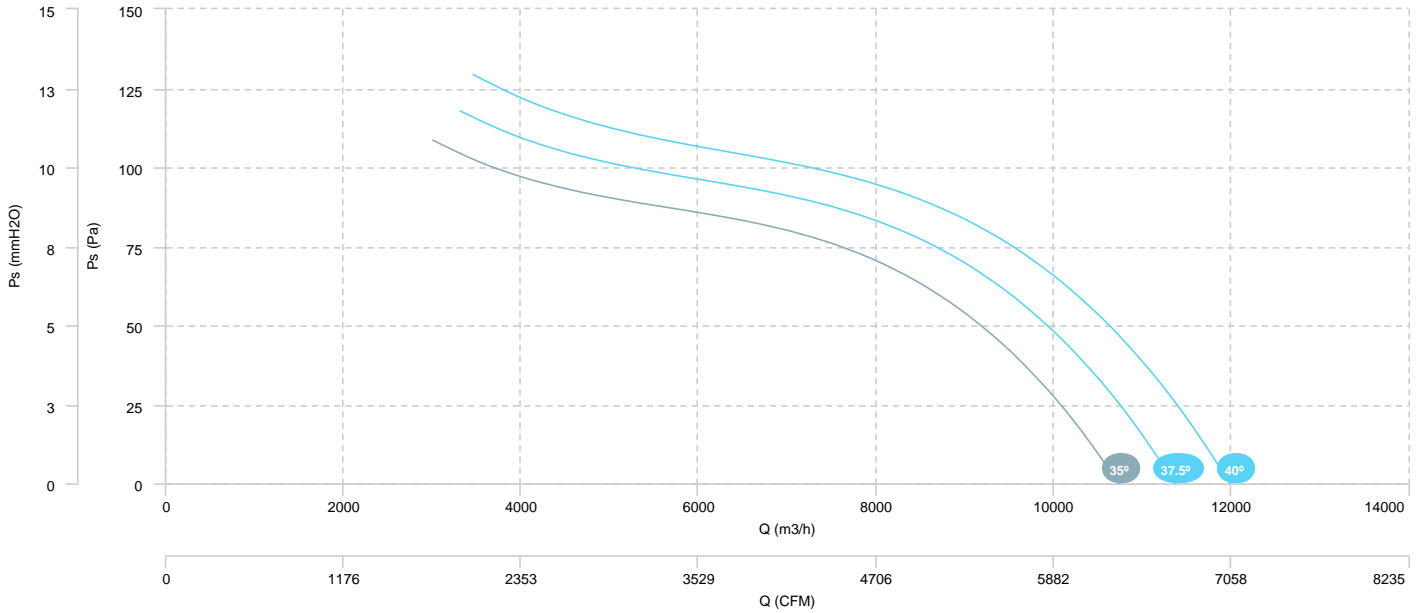

AIR FLOW - ABSORBED POWER

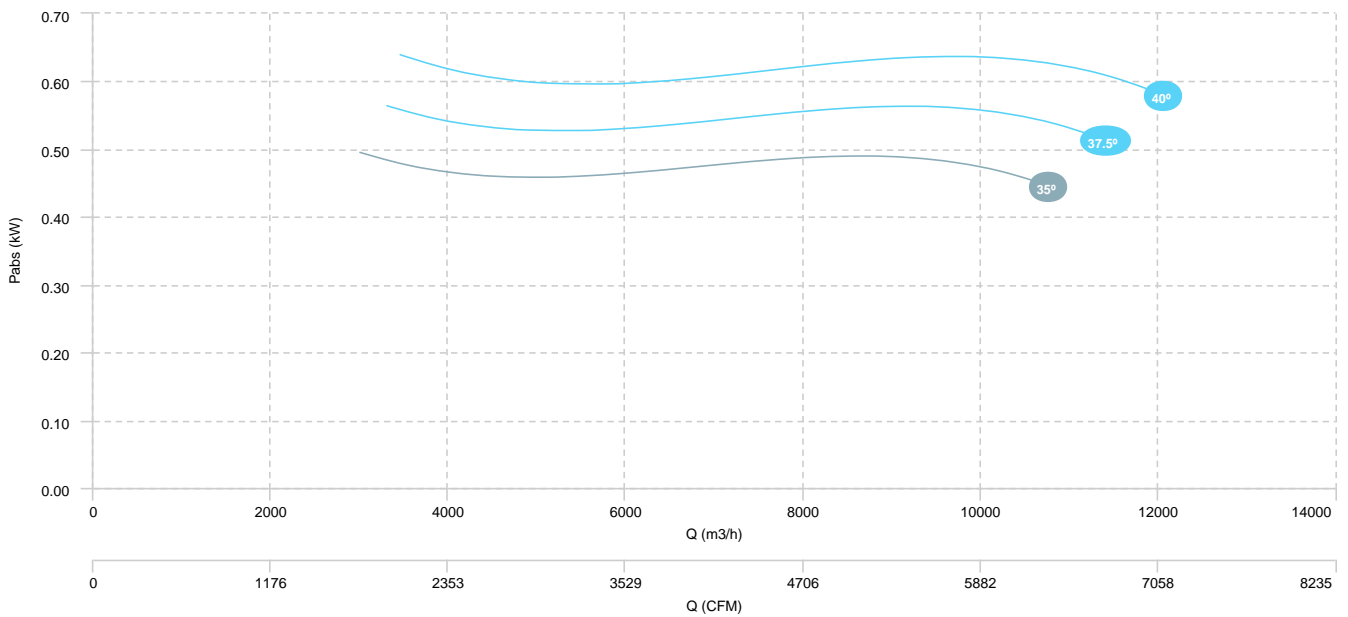

HBA 63 T6 0,55kW (A2:9)

HBA 63 T6 0,75kW (A2:9)

## AIR FLOW - PRESSURE

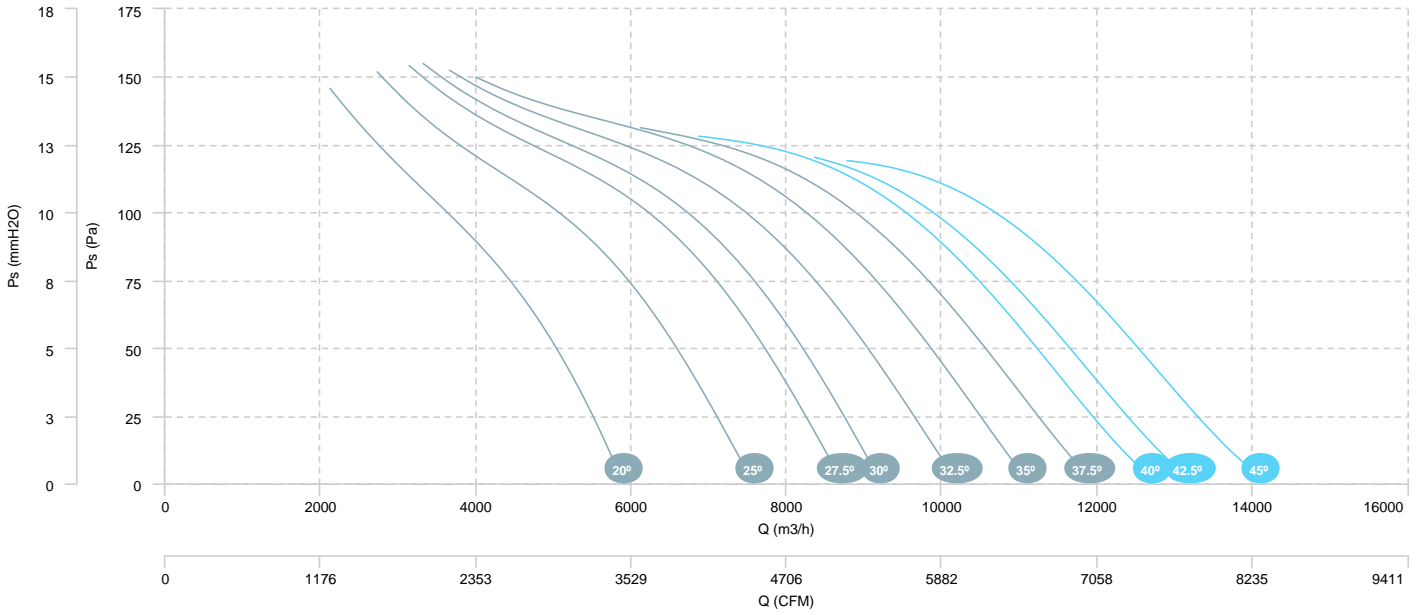

## AIR FLOW - ABSORBED POWER

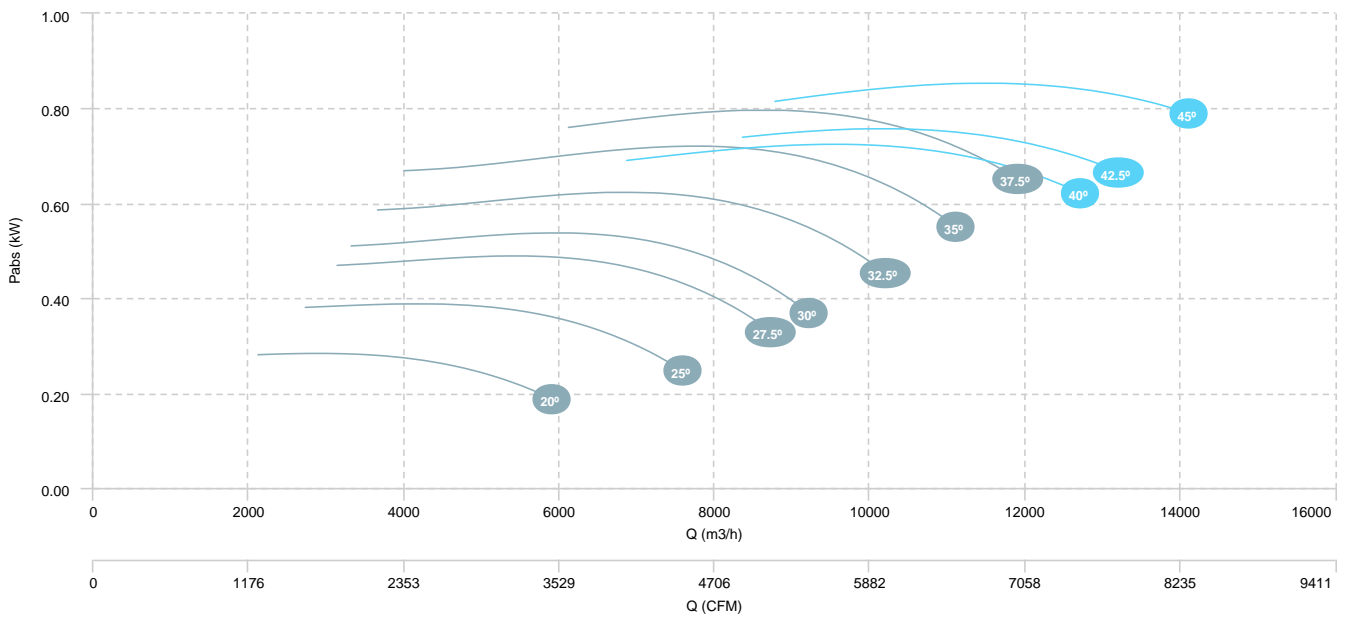

HBA 63 T4/T8 0,75/0,12kW (A5:6)  
 HBA 63 T4/T8 2,2/0,37kW (A5:6)

HBA 63 T4/T8 1,1/0,18kW (A5:6)

HBA 63 T4/T8 1,5/0,25kW (A5:6)

AIR FLOW - PRESSURE (4 poles)

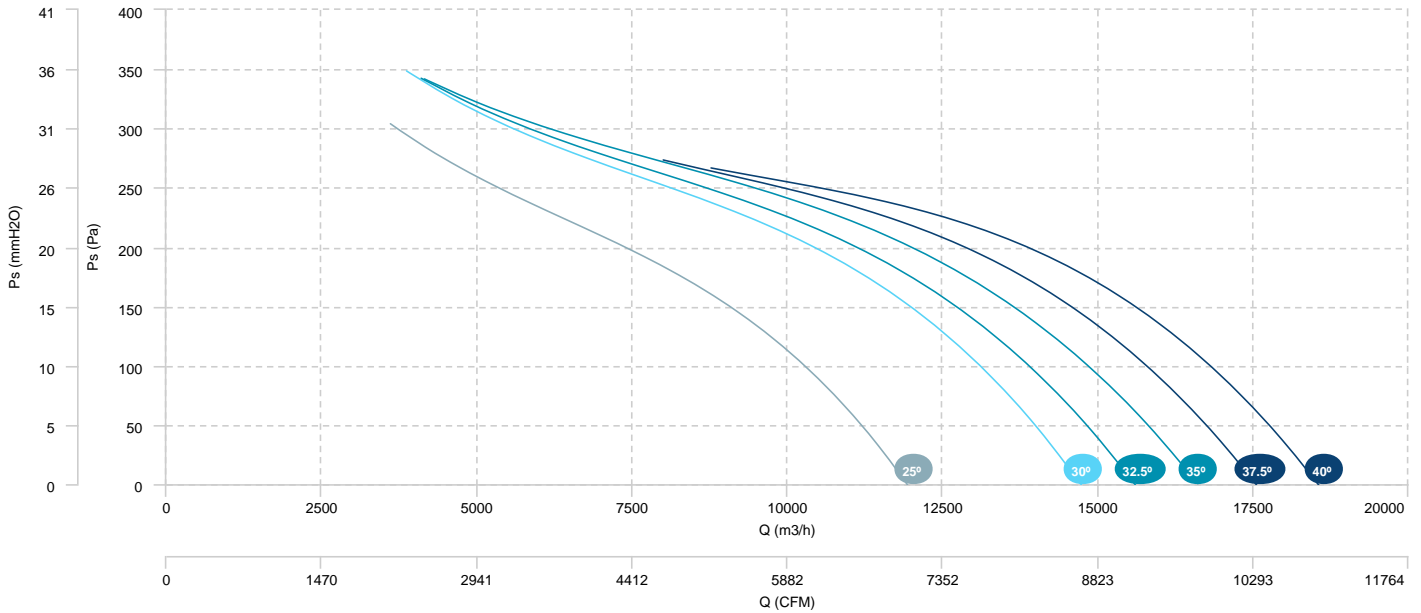

AIR FLOW - ABSORBED POWER (4 poles)

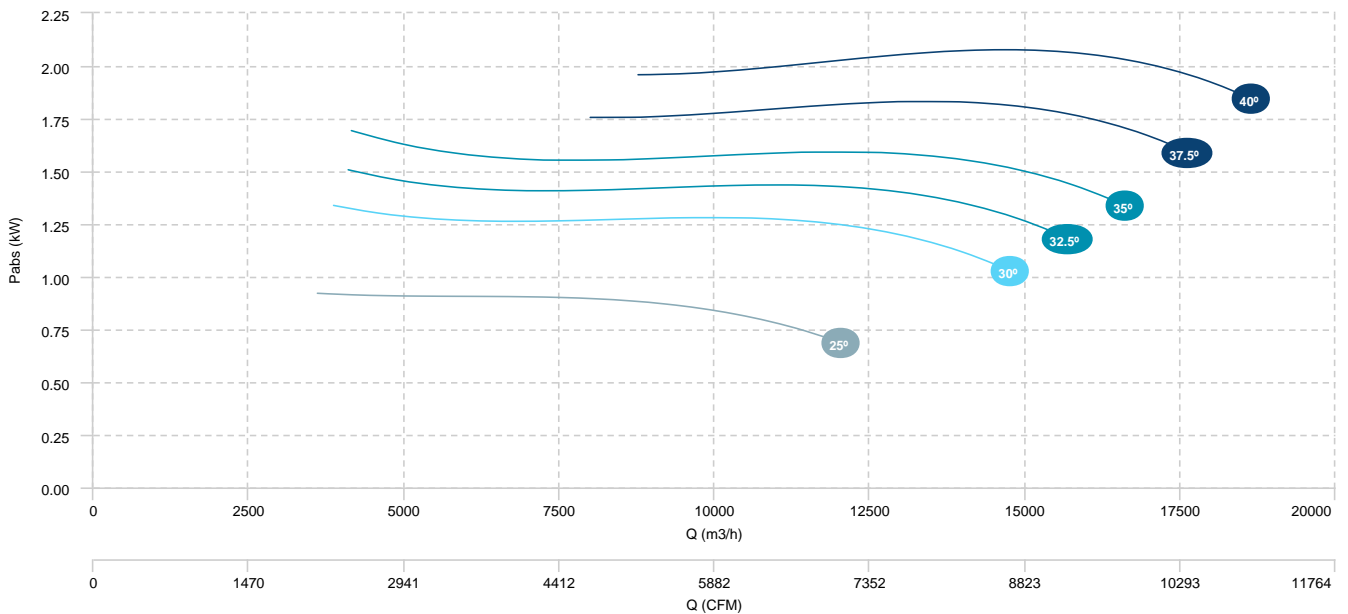



HBA 63 T4/T8 0,75/0,12kW (A5:6)

HBA 63 T4/T8 1,1/0,18kW (A5:6)

HBA 63 T4/T8 1,5/0,25kW (A5:6)

HBA 63 T4/T8 2,2/0,37kW (A5:6)

## AIR FLOW - PRESSURE (8 poles)

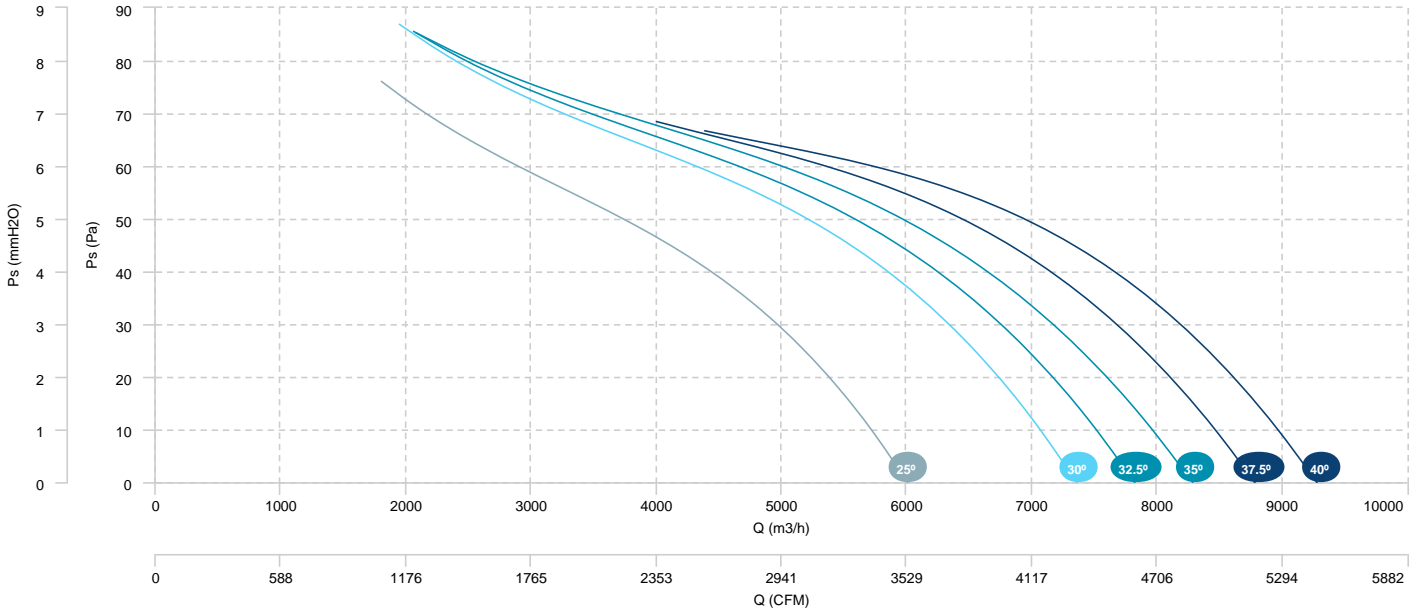

HBA 63 T4/T8 0,75/0,12kW (A2:9)	HBA 63 T4/T8 1,1/0,18kW (A2:9)	HBA 63 T4/T8 1,5/0,25kW (A2:9)
HBA 63 T4/T8 2,2/0,37kW (A2:9)	HBA 63 T4/T8 3/0,55kW (A2:9)	

AIR FLOW - PRESSURE (4 poles)

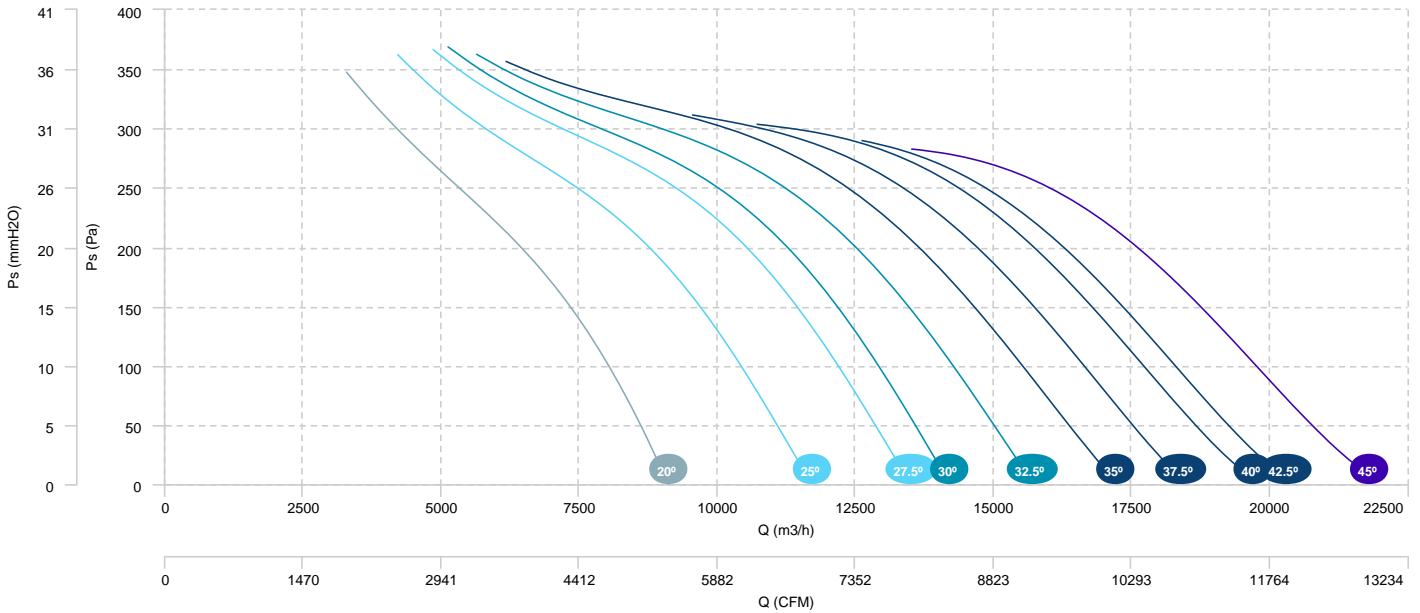

AIR FLOW - ABSORBED POWER (4 poles)

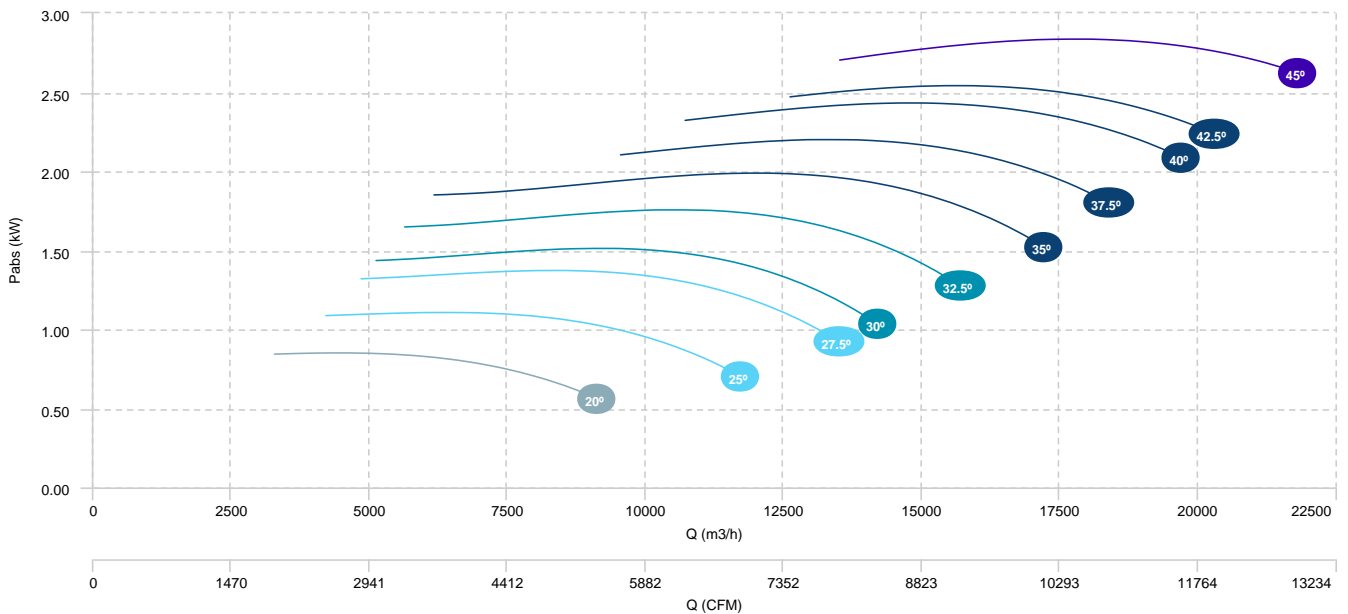

HBA 63 T4/T8 0,75/0,12kW (A2:9)	HBA 63 T4/T8 1,1/0,18kW (A2:9)	HBA 63 T4/T8 1,5/0,25kW (A2:9)
HBA 63 T4/T8 2,2/0,37kW (A2:9)	HBA 63 T4/T8 3/0,55kW (A2:9)	

## AIR FLOW - PRESSURE (8 poles)

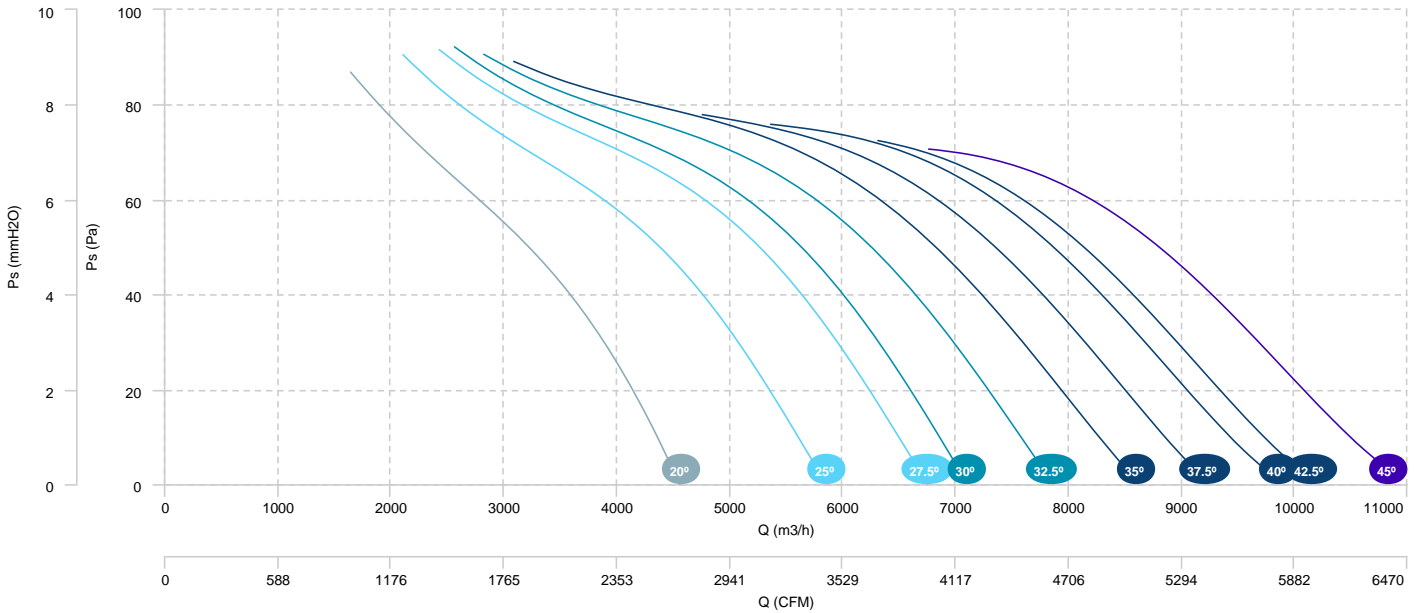

HBA 63 T4/T8 0,55/0,09kW (A2:6)	HBA 63 T4/T8 0,75/0,12kW (A2:6)	HBA 63 T4/T8 1,1/0,18kW (A2:6)
HBA 63 T4/T8 1,5/0,25kW (A2:6)	HBA 63 T4/T8 2,2/0,37kW (A2:6)	

## AIR FLOW - PRESSURE (4 poles)

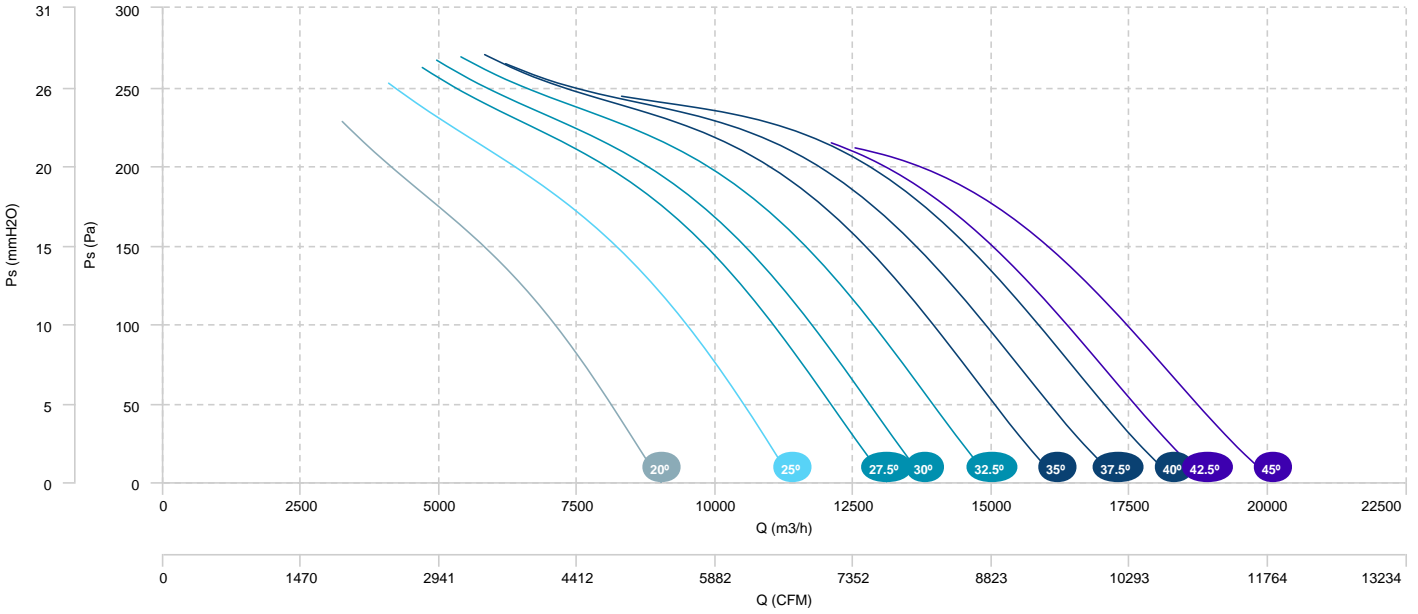

## AIR FLOW - ABSORBED POWER (4 poles)

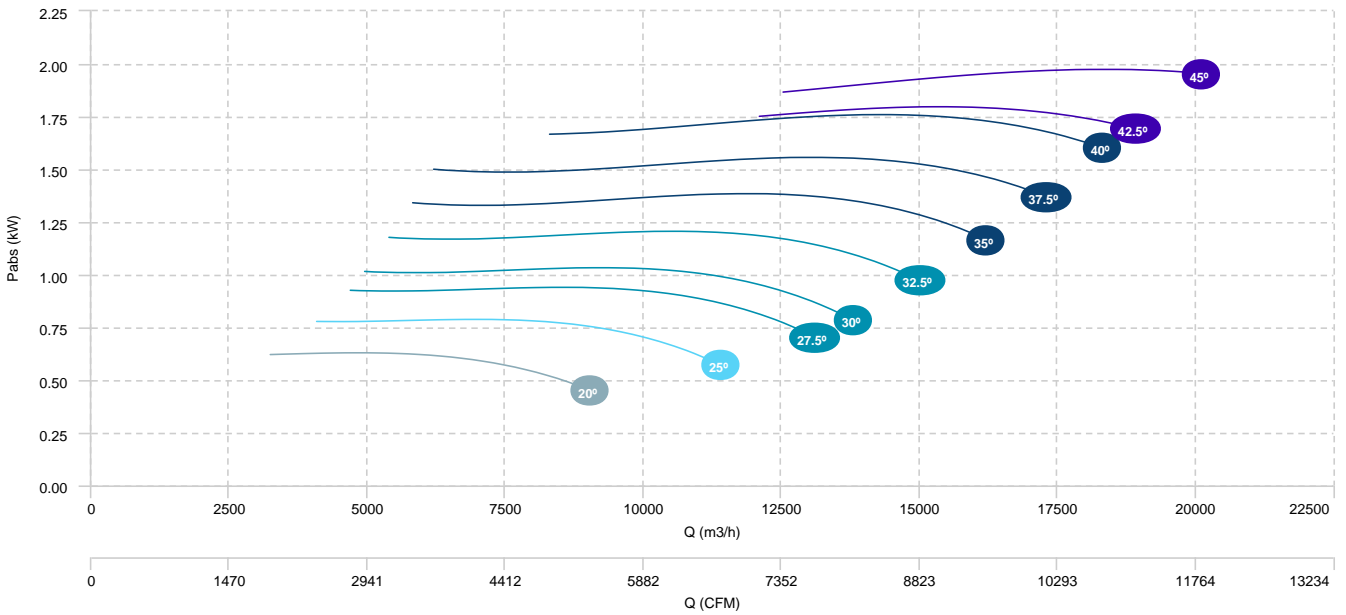

HBA 63 T4/T8 0,55/0,09kW (A2:6)	HBA 63 T4/T8 0,75/0,12kW (A2:6)	HBA 63 T4/T8 1,1/0,18kW (A2:6)
HBA 63 T4/T8 1,5/0,25kW (A2:6)	HBA 63 T4/T8 2,2/0,37kW (A2:6)	

## AIR FLOW - PRESSURE (8 poles)

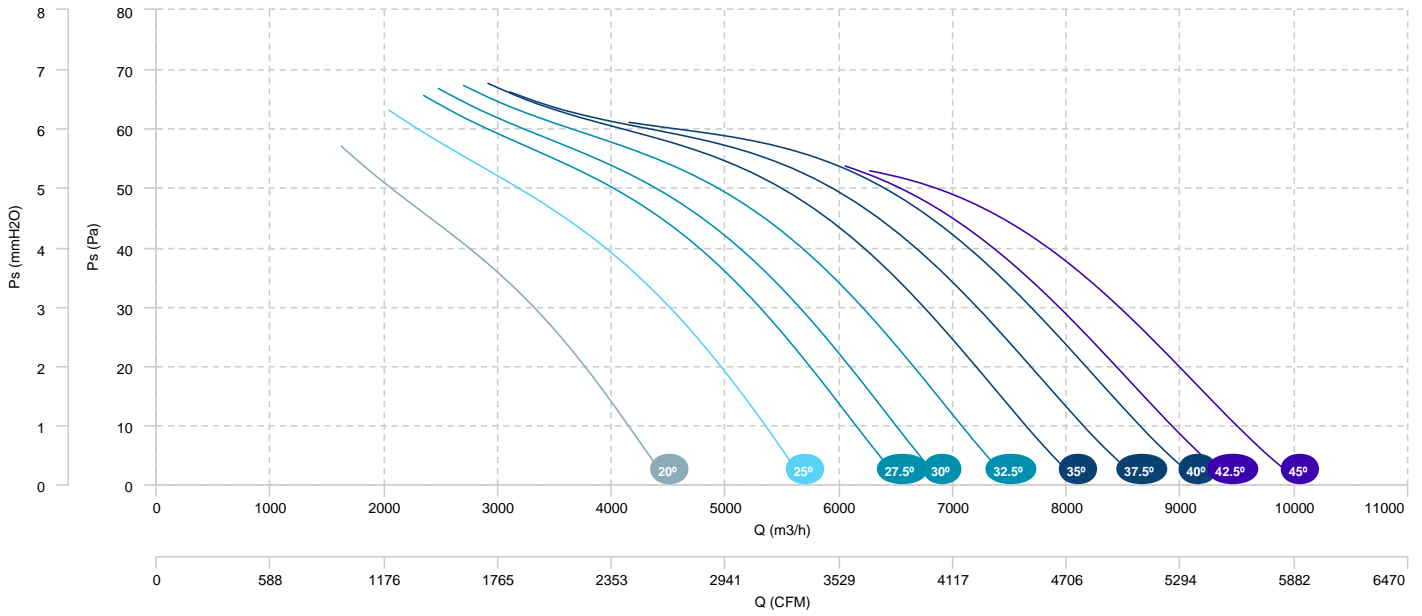

HBA 71 T4 0,75kW (A2:6)	HBA 71 T4 1,1kW (A2:6)	HBA 71 T4 1,5kW (A2:6)
HBA 71 T4 2,2kW (A2:6)	HBA 71 T4 3kW (A2:6)	

## AIR FLOW - PRESSURE

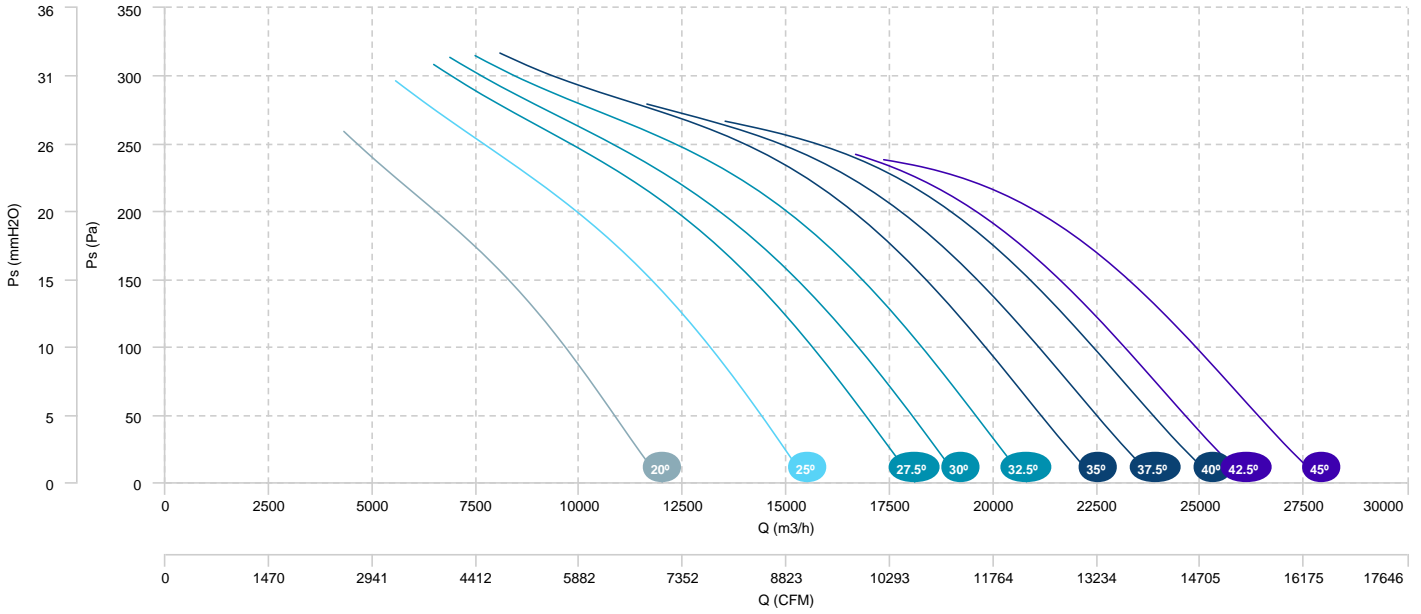

## AIR FLOW - ABSORBED POWER

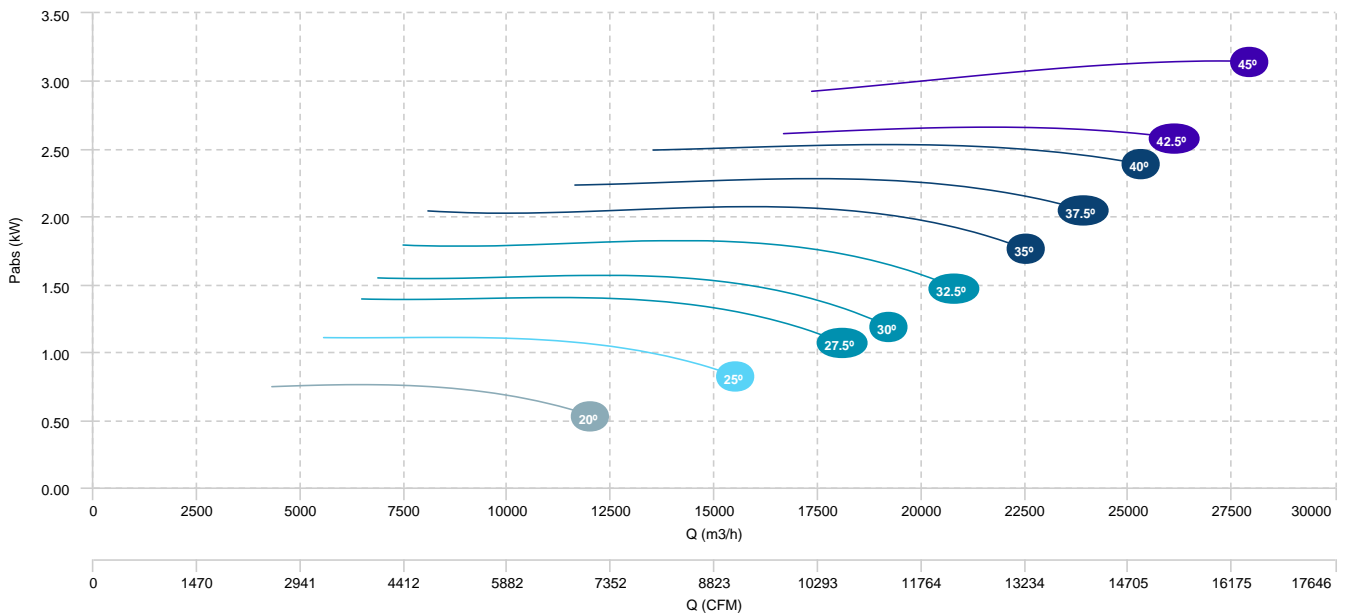

HBA 71 T4 0,75kW (A5:6)	HBA 71 T4 1,1kW (A5:6)	HBA 71 T4 1,5kW (A5:6)
HBA 71 T4 2,2kW (A5:6)	HBA 71 T4 3kW (A5:6)	

## AIR FLOW - PRESSURE

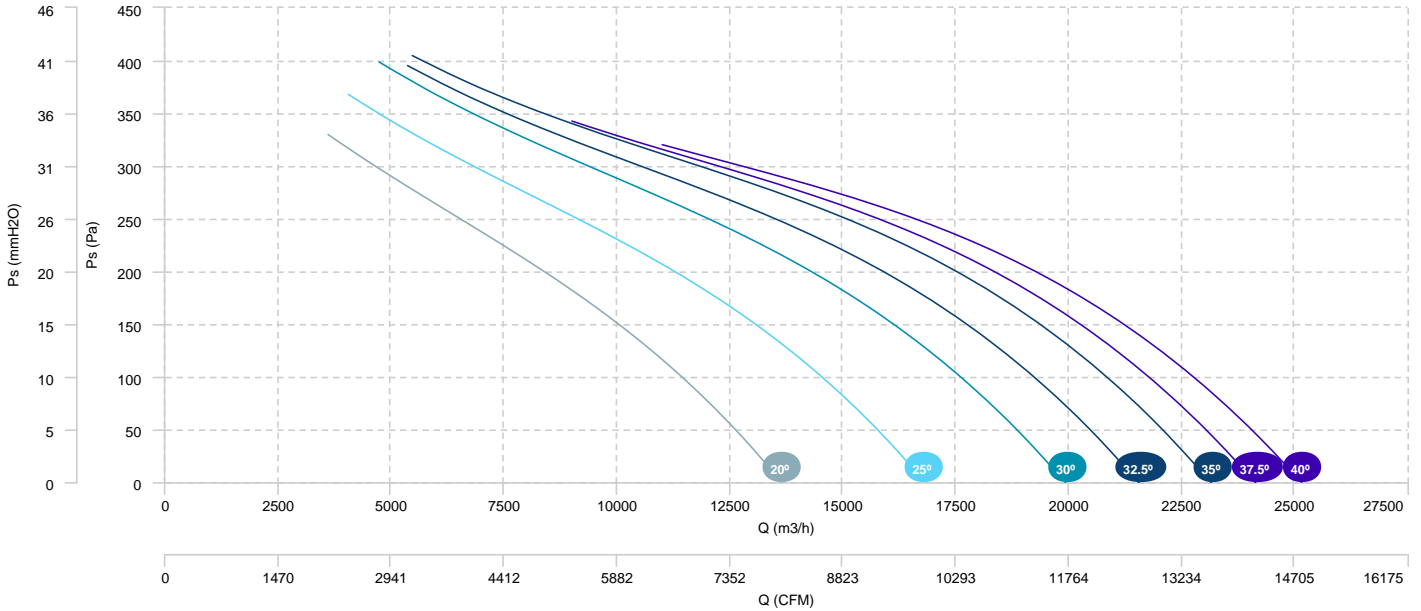

## AIR FLOW - ABSORBED POWER

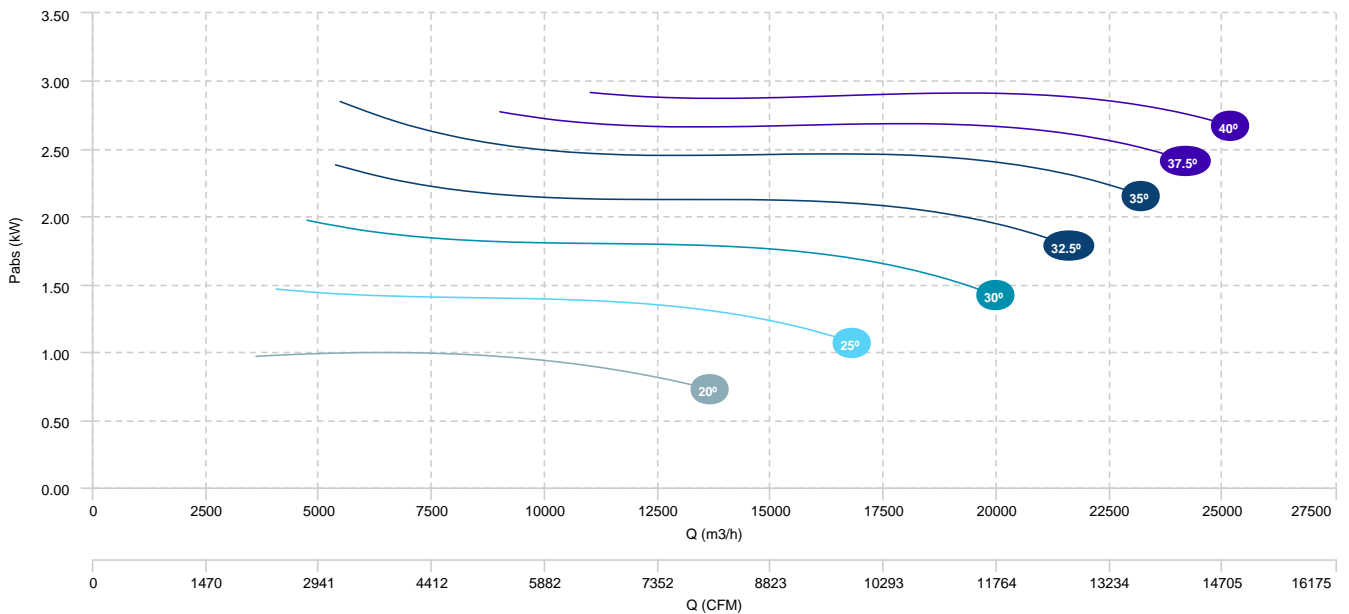

HBA 71 T4 1,1kW (A2:9)  
HBA 71 T4 3kW (A2:9)

HBA 71 T4 1,5kW (A2:9)

HBA 71 T4 2,2kW (A2:9)

## AIR FLOW - PRESSURE

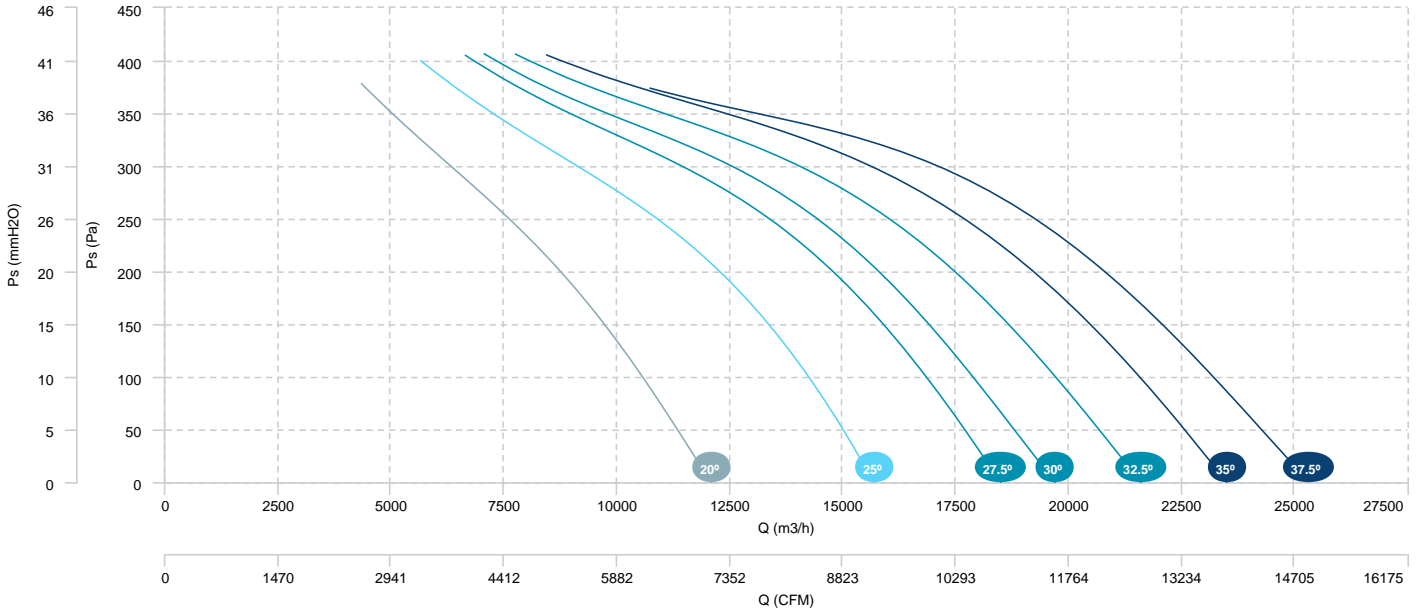

## AIR FLOW - ABSORBED POWER

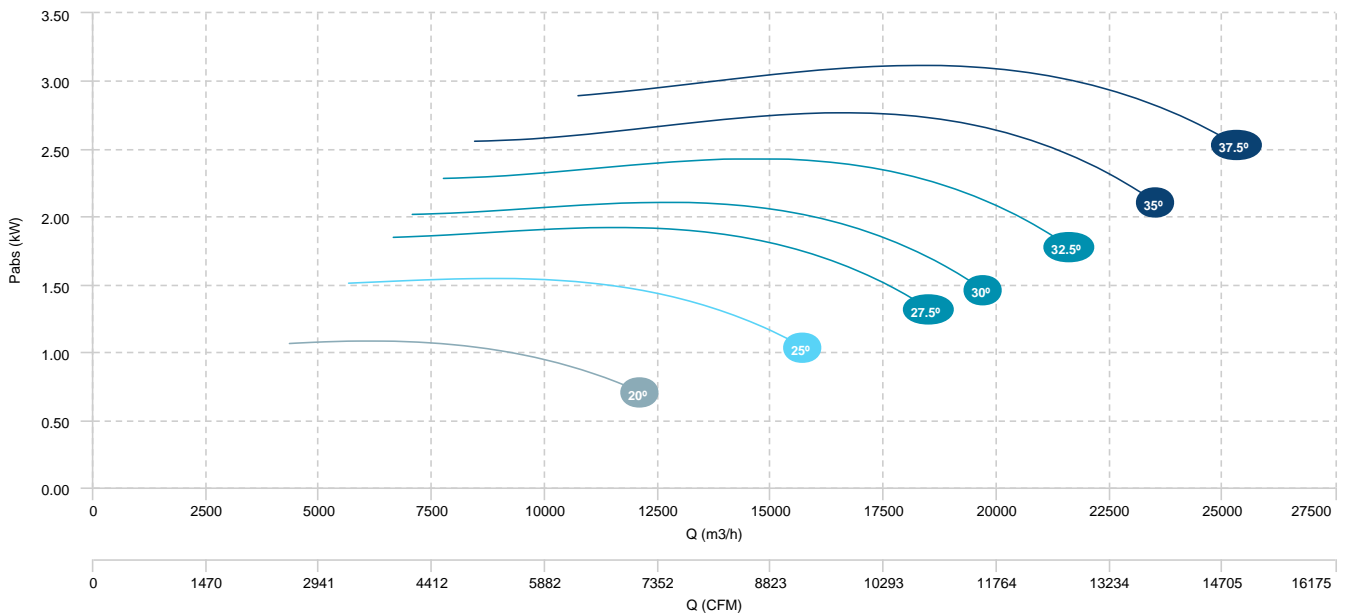



HBA 71 T6 0,75kW (A5:6)

AIR FLOW - PRESSURE

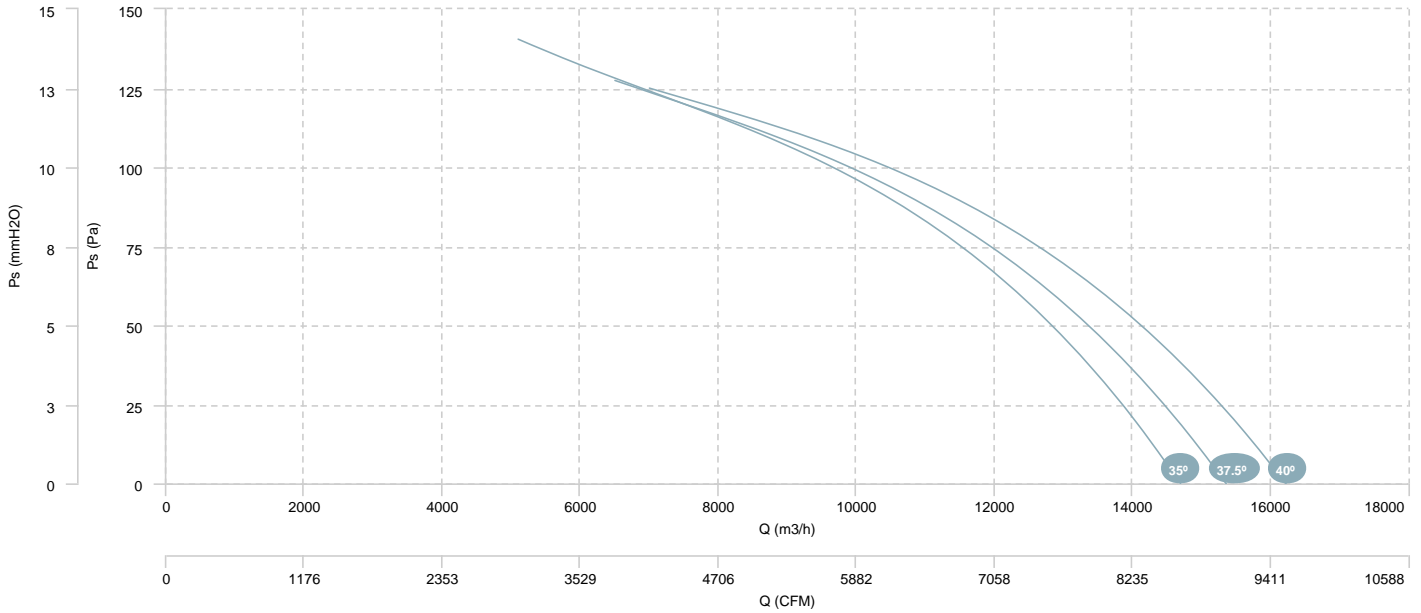

AIR FLOW - ABSORBED POWER

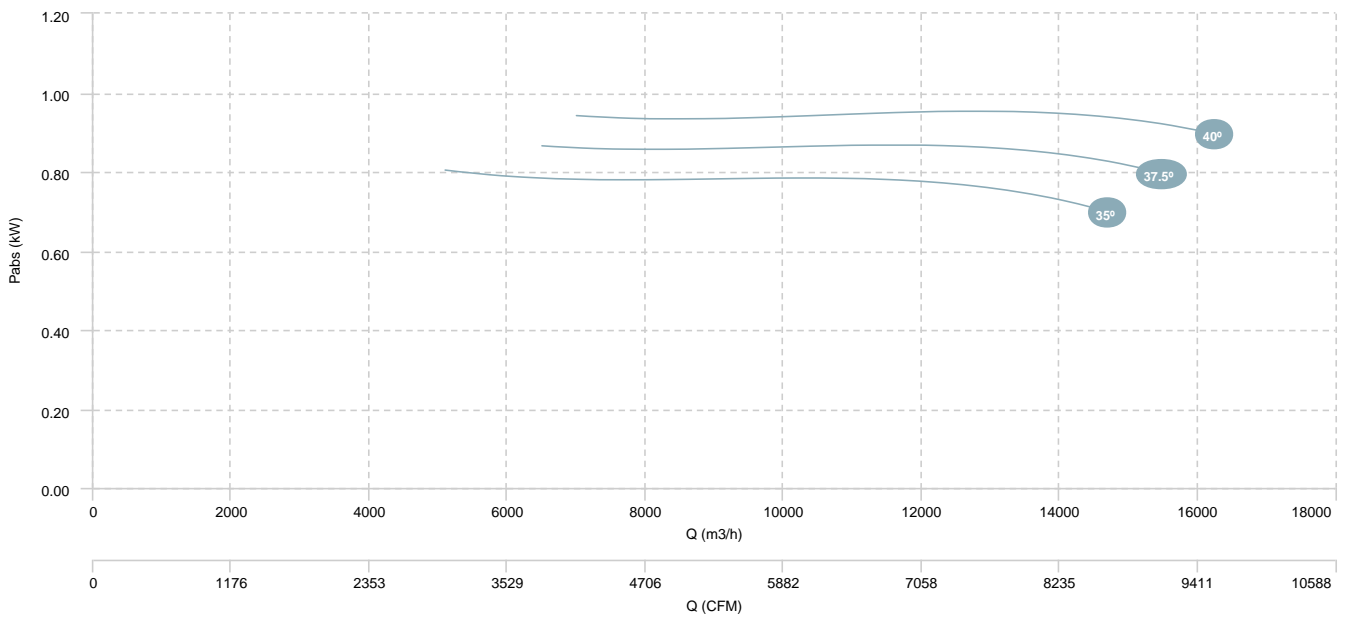

HBA 71 T6 0,55kW (A2:9)

HBA 71 T6 0,75kW (A2:9)

HBA 71 T6 1,1kW (A2:9)

## AIR FLOW - PRESSURE

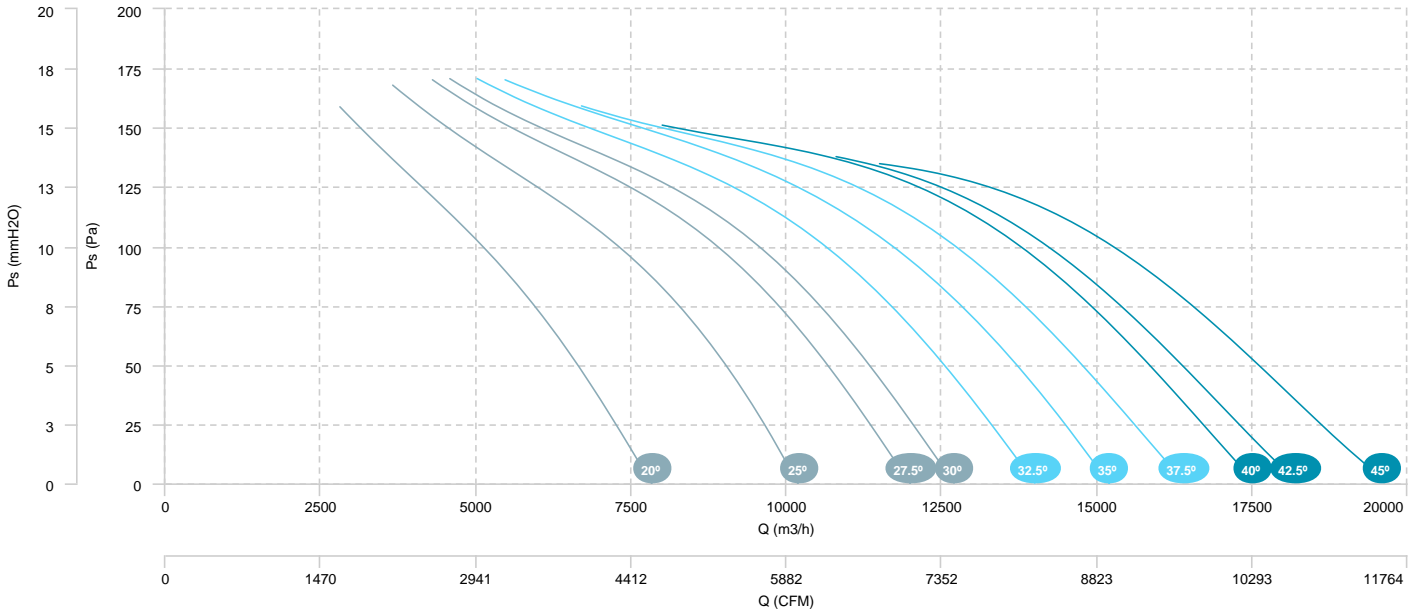

## AIR FLOW - ABSORBED POWER

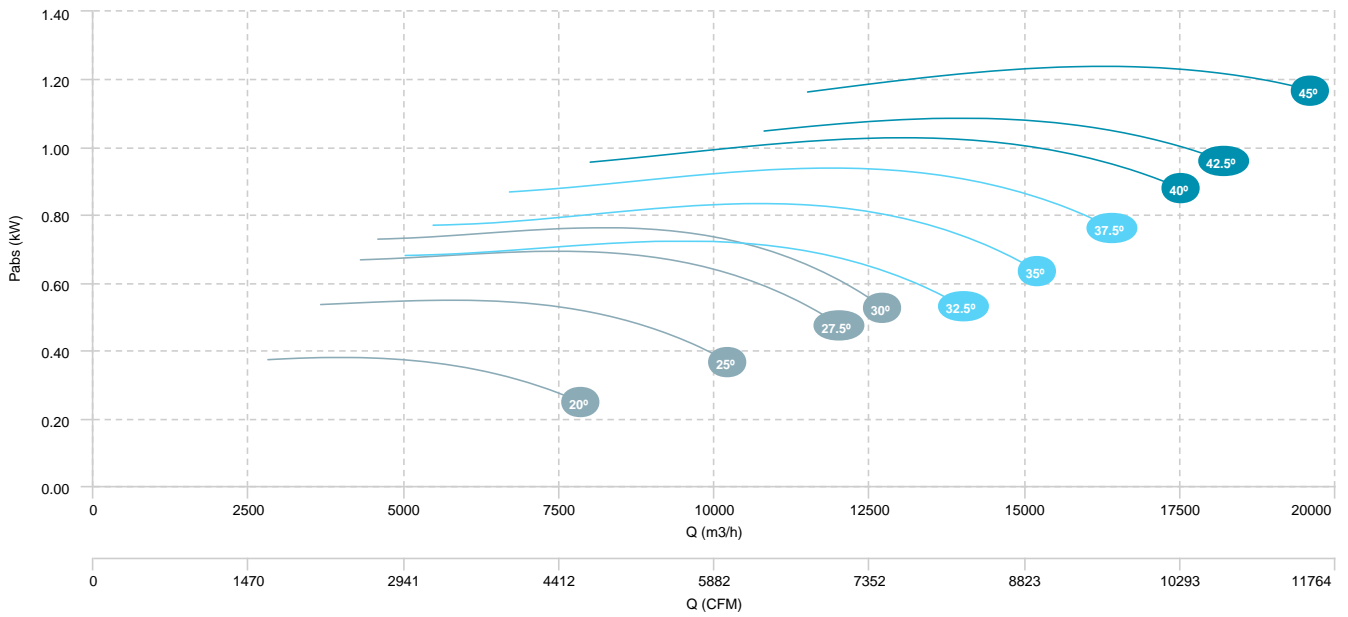

HBA 71 T6 0,55kW (A2:6)

HBA 71 T6 0,75kW (A2:6)

AIR FLOW - PRESSURE

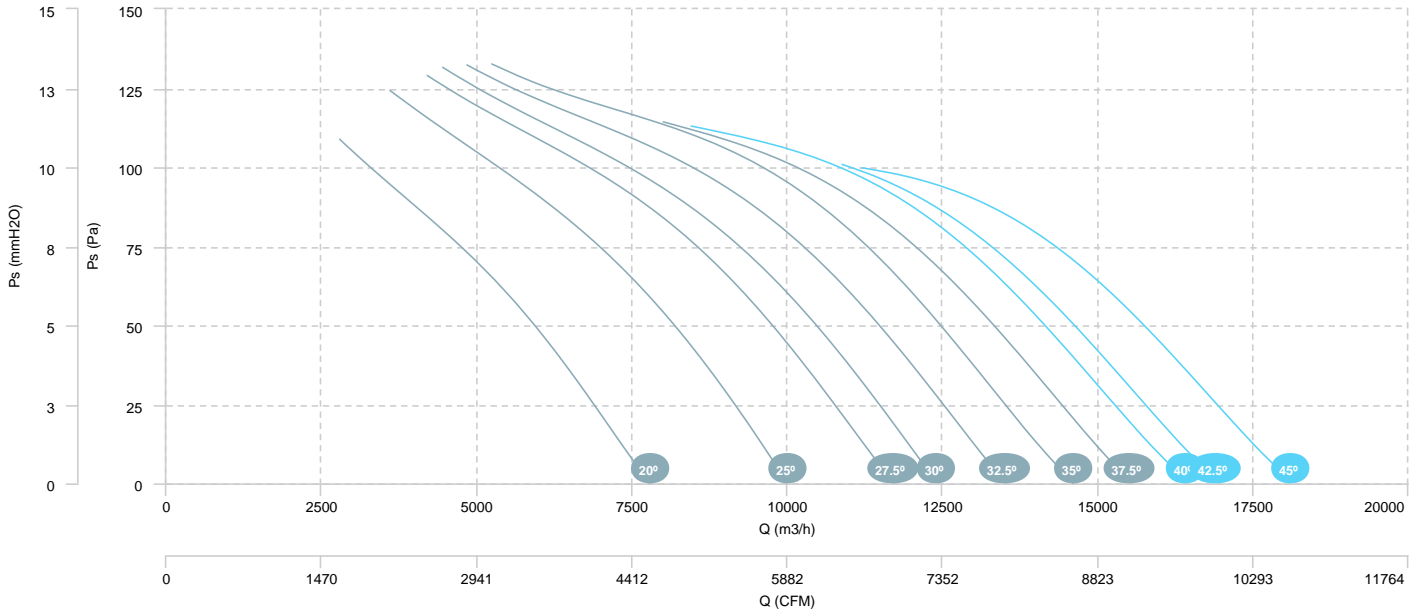

AIR FLOW - ABSORBED POWER

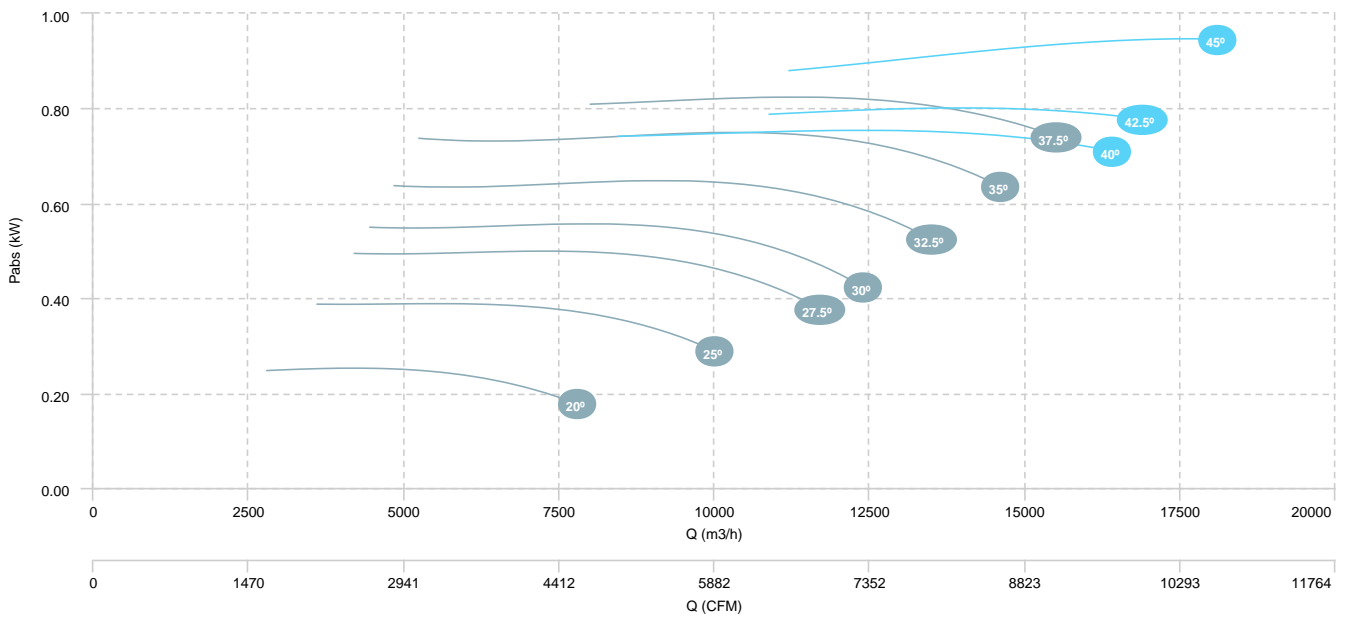

HBA 71 T4/T8 0,75/0,12kW (A5:6)	HBA 71 T4/T8 1,1/0,18kW (A5:6)	HBA 71 T4/T8 1,5/0,25kW (A5:6)
HBA 71 T4/T8 2,2/0,37kW (A5:6)	HBA 71 T4/T8 3/0,55kW (A5:6)	

## AIR FLOW - PRESSURE (4 poles)

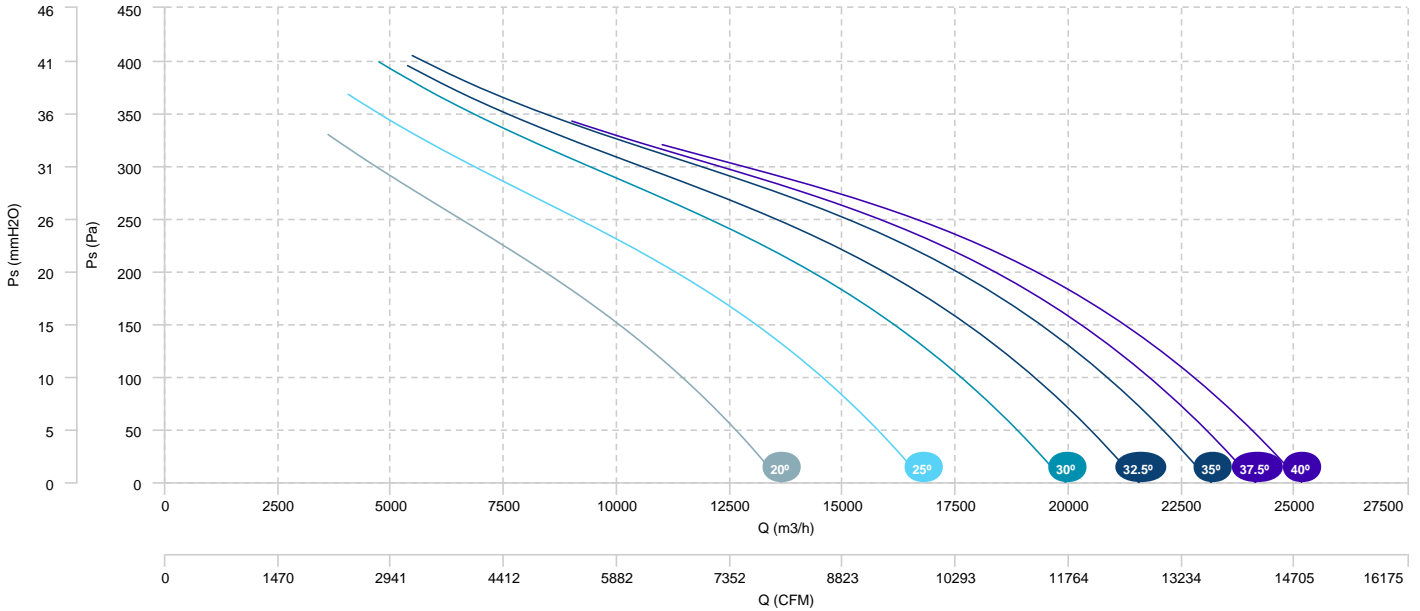

## AIR FLOW - ABSORBED POWER (4 poles)

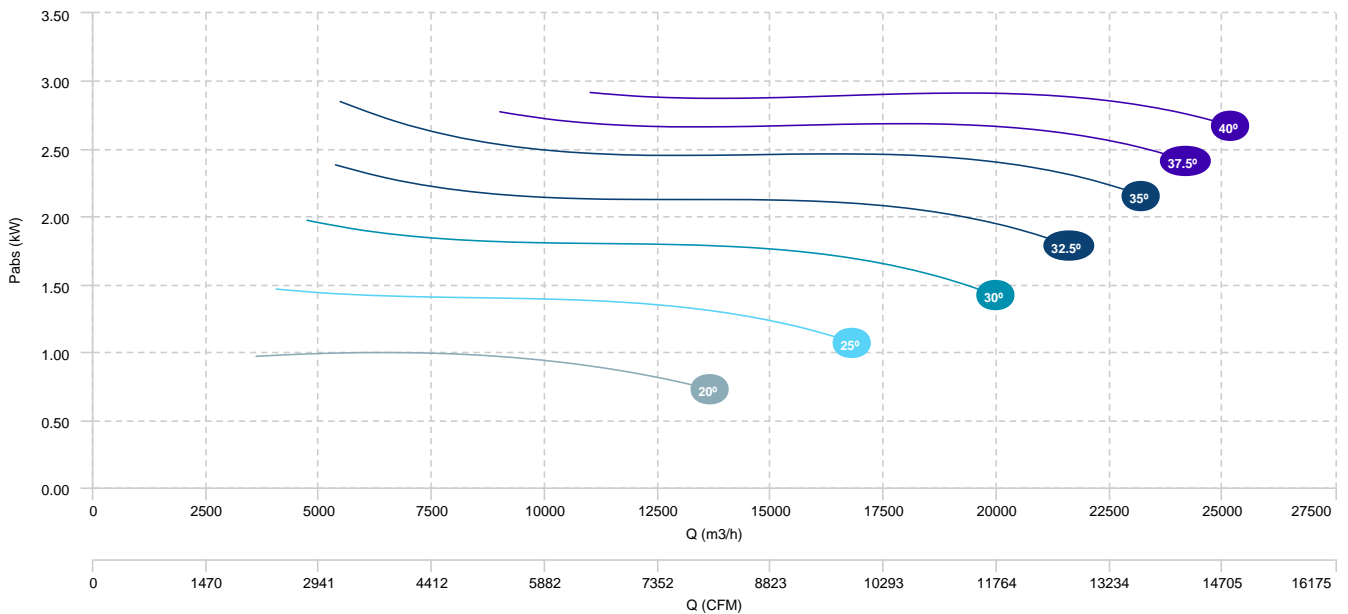

HBA 71 T4/T8 0,75/0,12kW (A5:6)	HBA 71 T4/T8 1,1/0,18kW (A5:6)	HBA 71 T4/T8 1,5/0,25kW (A5:6)
HBA 71 T4/T8 2,2/0,37kW (A5:6)	HBA 71 T4/T8 3/0,55kW (A5:6)	

## AIR FLOW - PRESSURE (8 poles)

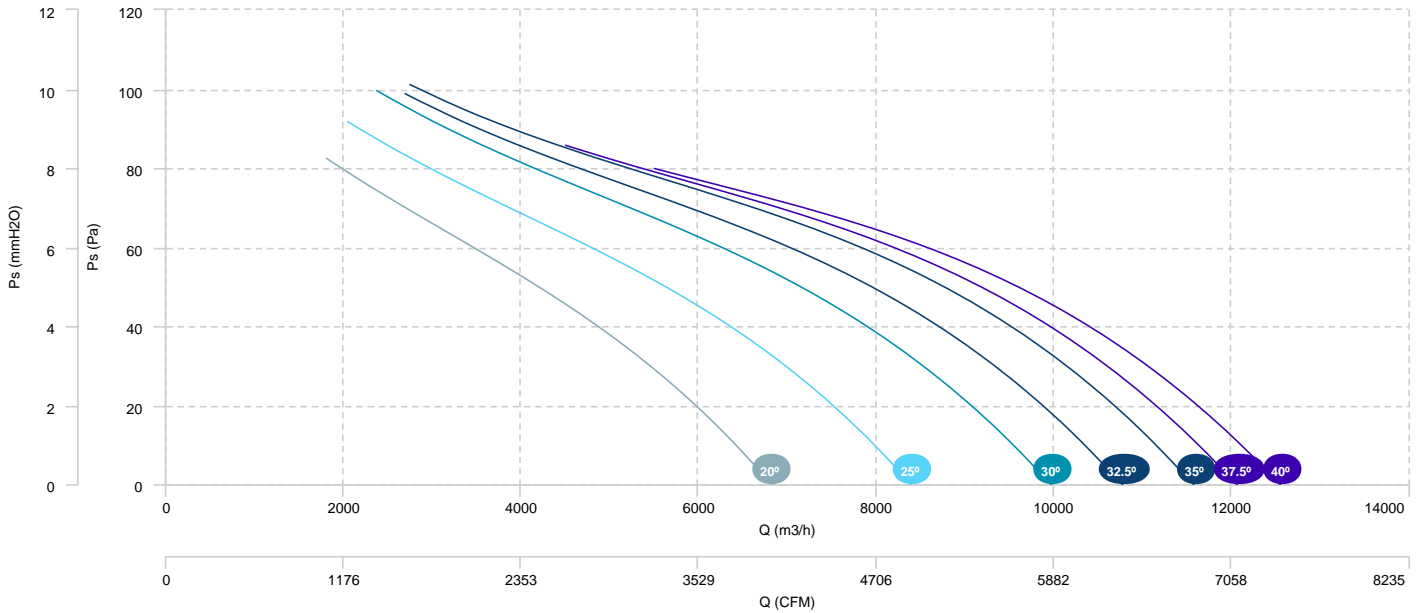

HBA 71 T4/T8 1,1/0,18kW (A2:9)

HBA 71 T4/T8 1,5/0,25kW (A2:9)

HBA 71 T4/T8 2,2/0,37kW (A2:9)

HBA 71 T4/T8 3/0,55kW (A2:9)

## AIR FLOW - PRESSURE (4 poles)

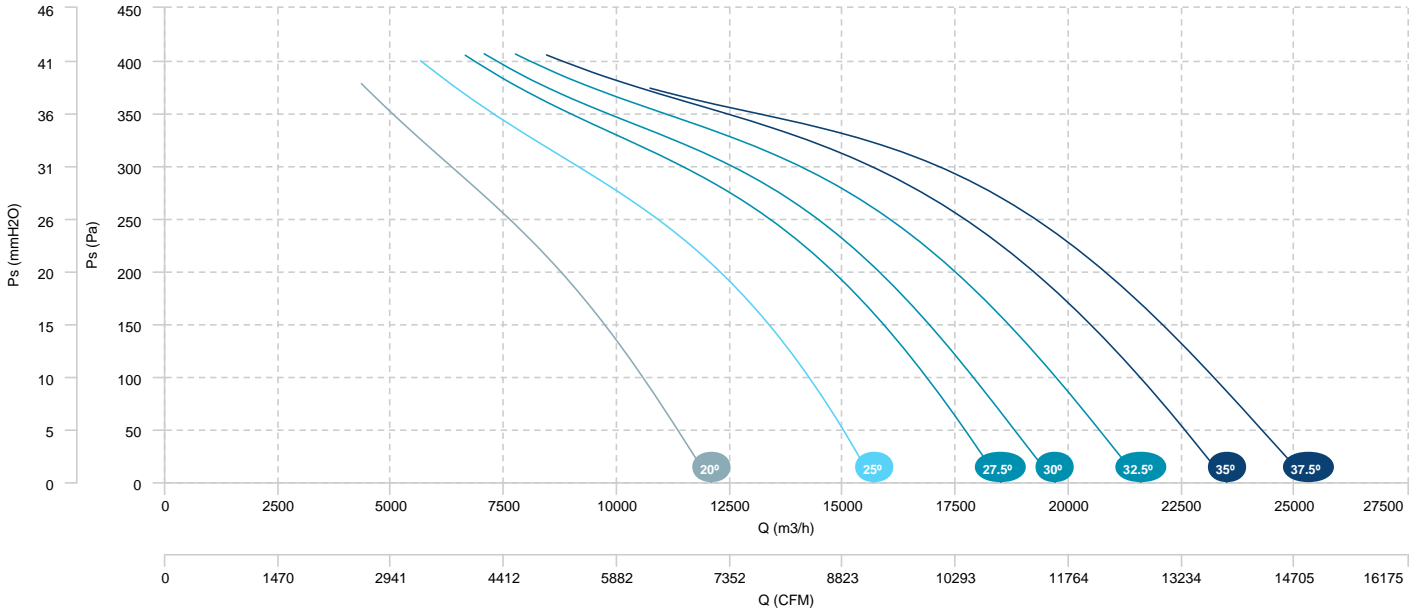

## AIR FLOW - ABSORBED POWER (4 poles)

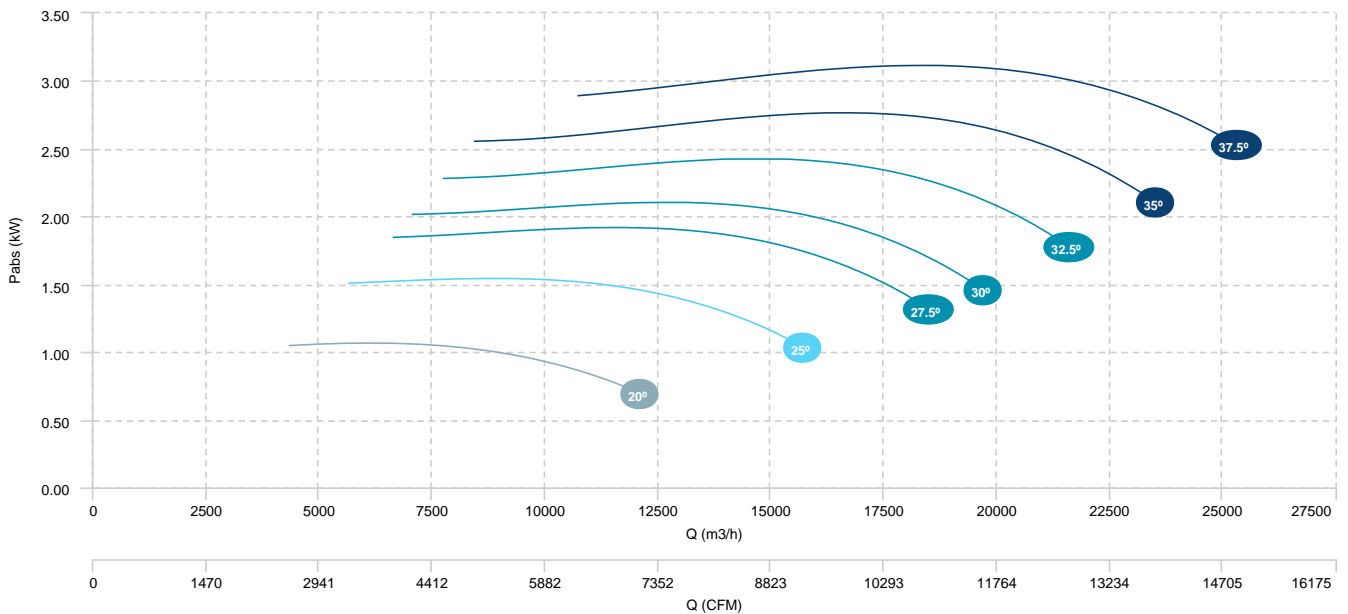

HBA 71 T4/T8 1,1/0,18kW (A2:9)	HBA 71 T4/T8 1,5/0,25kW (A2:9)	HBA 71 T4/T8 2,2/0,37kW (A2:9)
HBA 71 T4/T8 3/0,55kW (A2:9)		

## AIR FLOW - PRESSURE (8 poles)

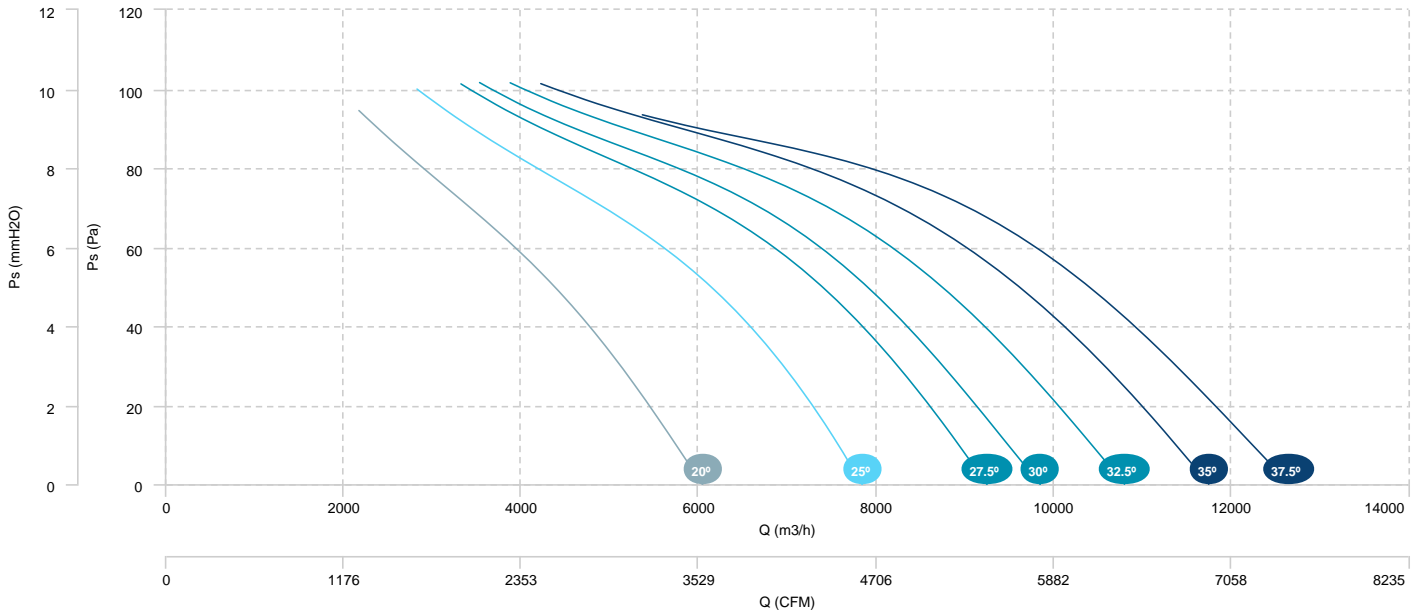

HBA 71 T4/T8 0,75/0,12kW (A2:6)	HBA 71 T4/T8 1,1/0,18kW (A2:6)	HBA 71 T4/T8 1,5/0,25kW (A2:6)
HBA 71 T4/T8 2,2/0,37kW (A2:6)	HBA 71 T4/T8 3/0,55kW (A2:6)	

## AIR FLOW - PRESSURE (4 poles)

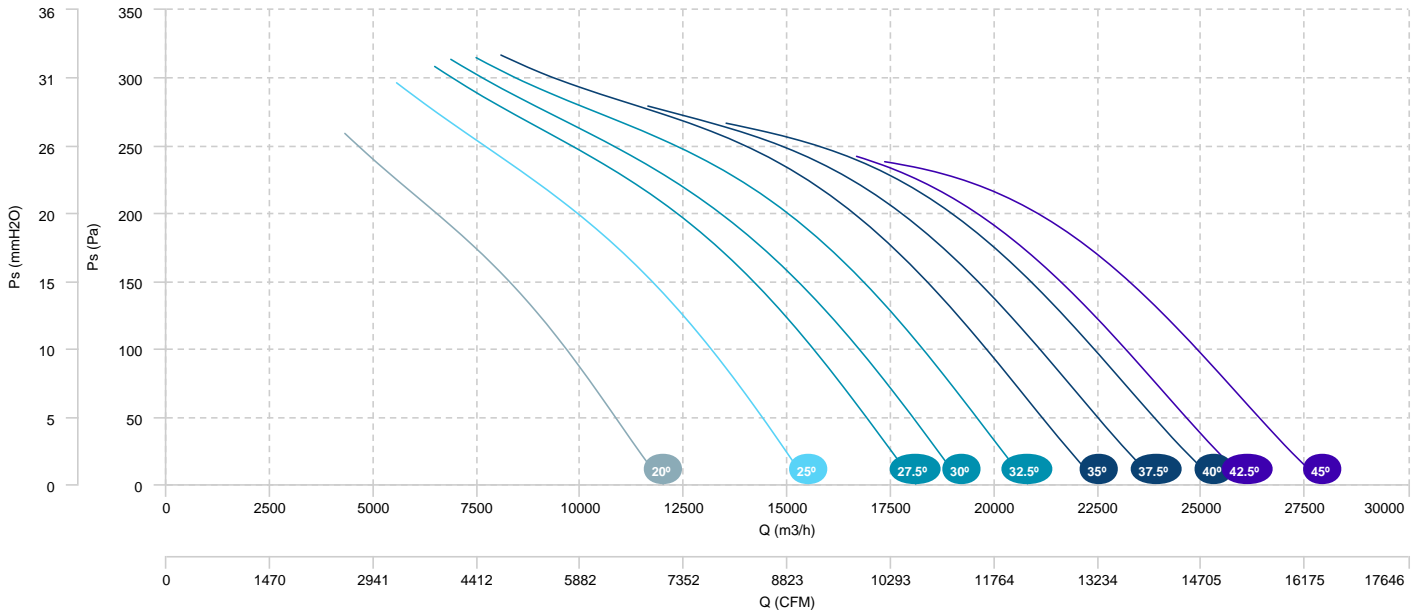

## AIR FLOW - ABSORBED POWER (4 poles)

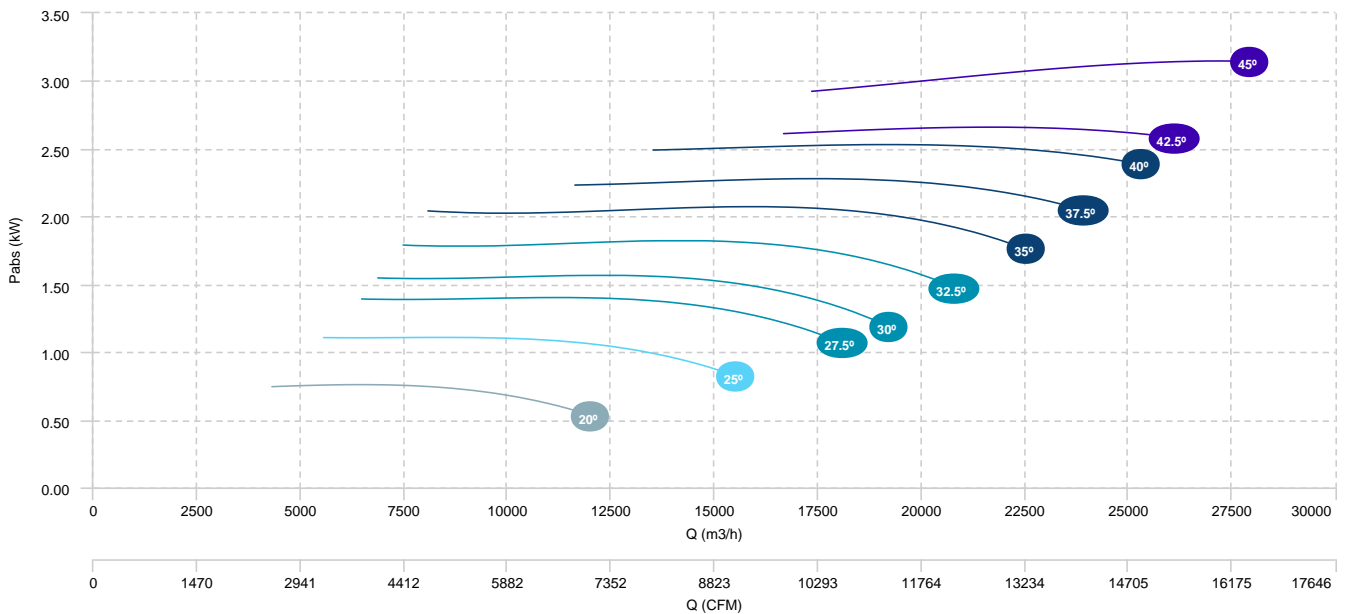



HBA 71 T4/T8 0,75/0,12kW (A2:6)	HBA 71 T4/T8 1,1/0,18kW (A2:6)	HBA 71 T4/T8 1,5/0,25kW (A2:6)
HBA 71 T4/T8 2,2/0,37kW (A2:6)	HBA 71 T4/T8 3/0,55kW (A2:6)	

## AIR FLOW - PRESSURE (8 poles)

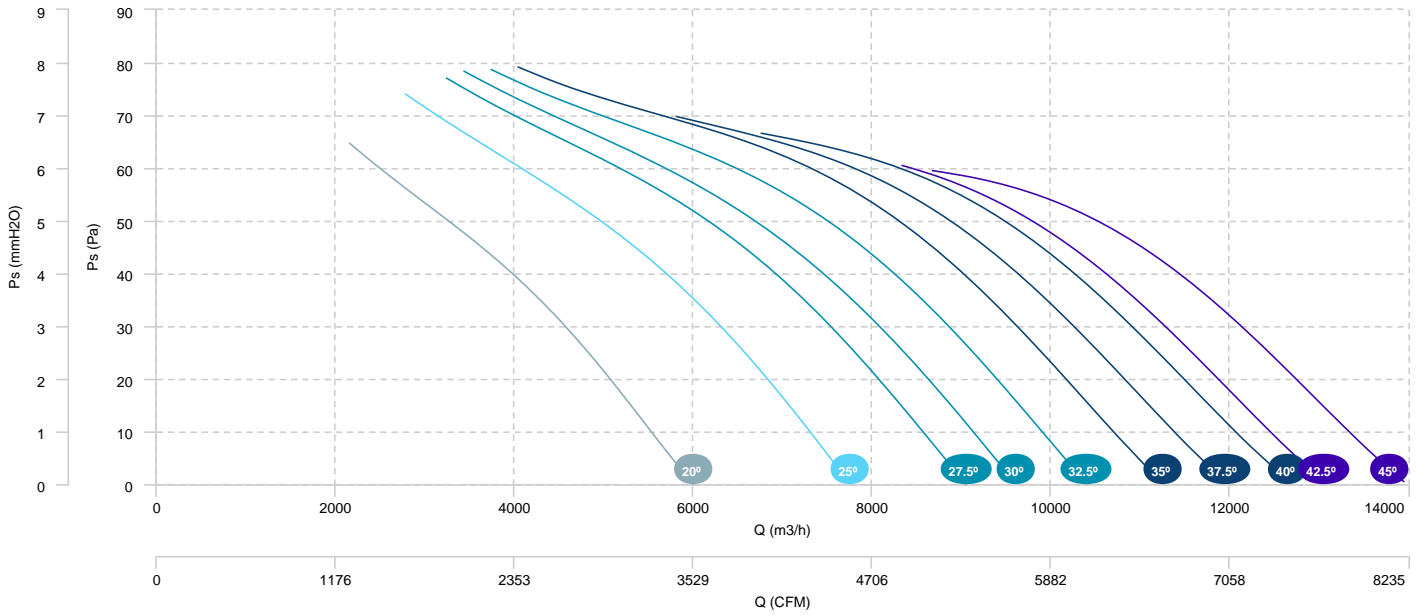

HBA 80 T4 3kW (A5:6)

HBA 80 T4 4kW (A5:6)

## AIR FLOW - PRESSURE

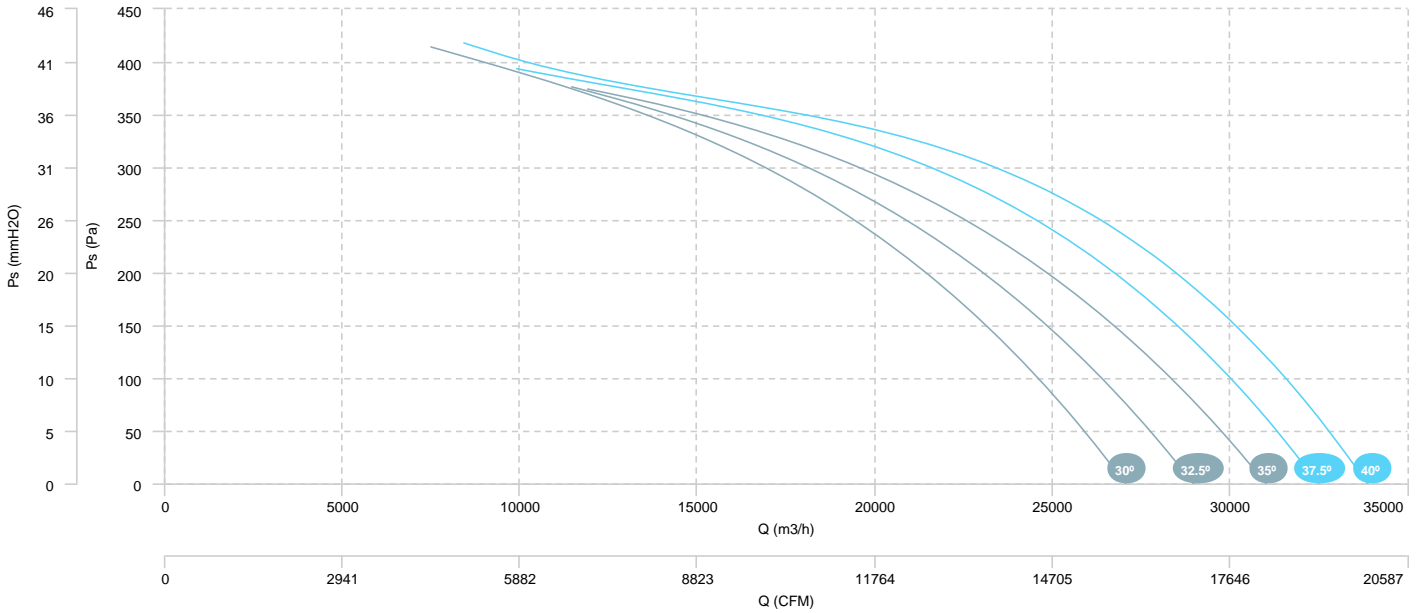

## AIR FLOW - ABSORBED POWER

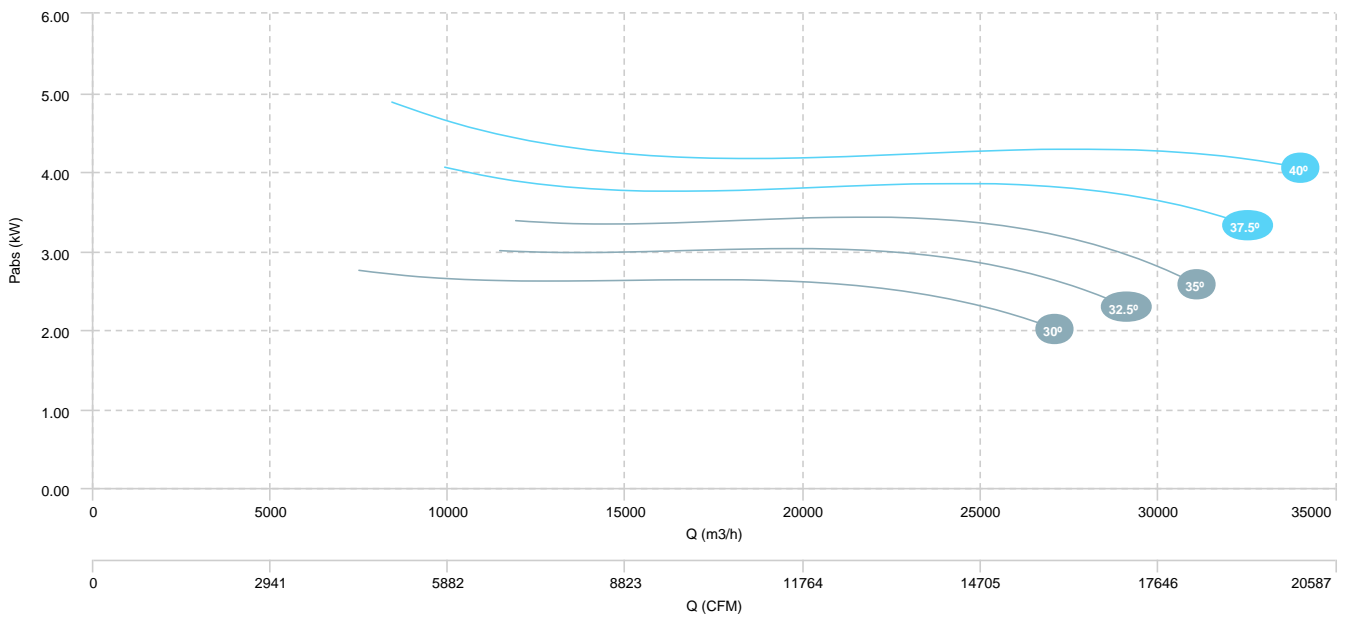

HBA 80 T4 1,5kW (A2:9)	HBA 80 T4 2,2kW (A2:9)	HBA 80 T4 3kW (A2:9)
HBA 80 T4 4kW (A2:9)	HBA 80 T4 5,5kW (A2:9)	

## AIR FLOW - PRESSURE

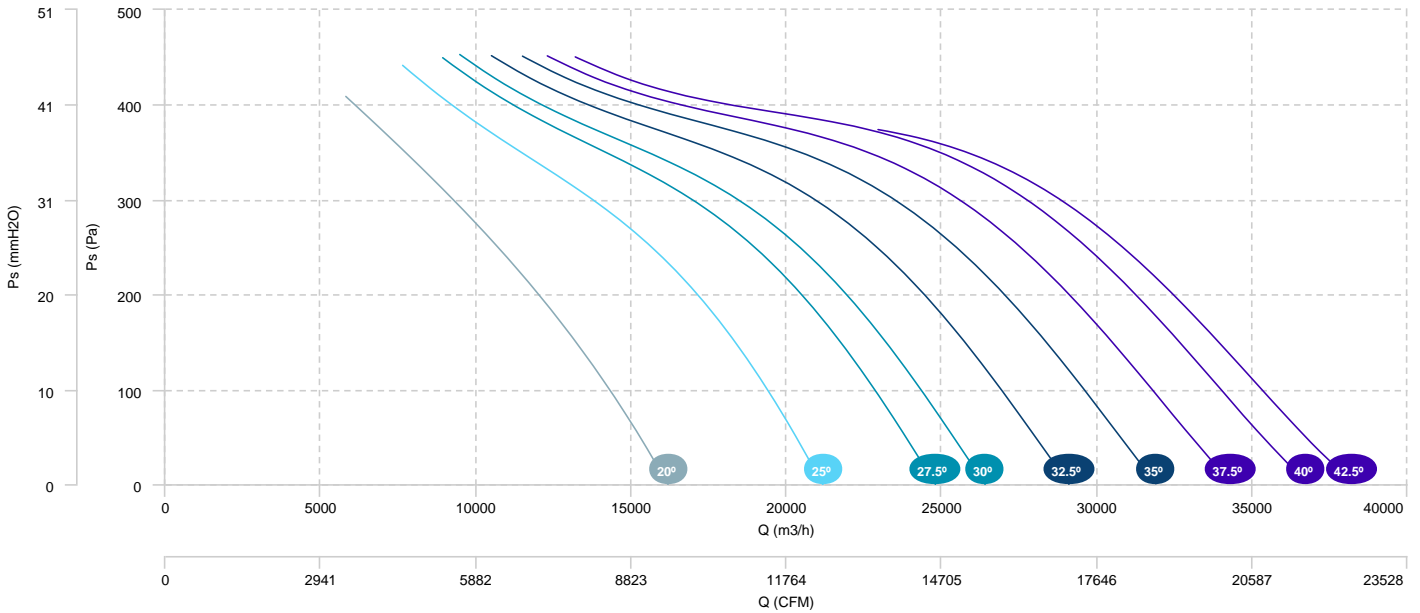

## AIR FLOW - ABSORBED POWER

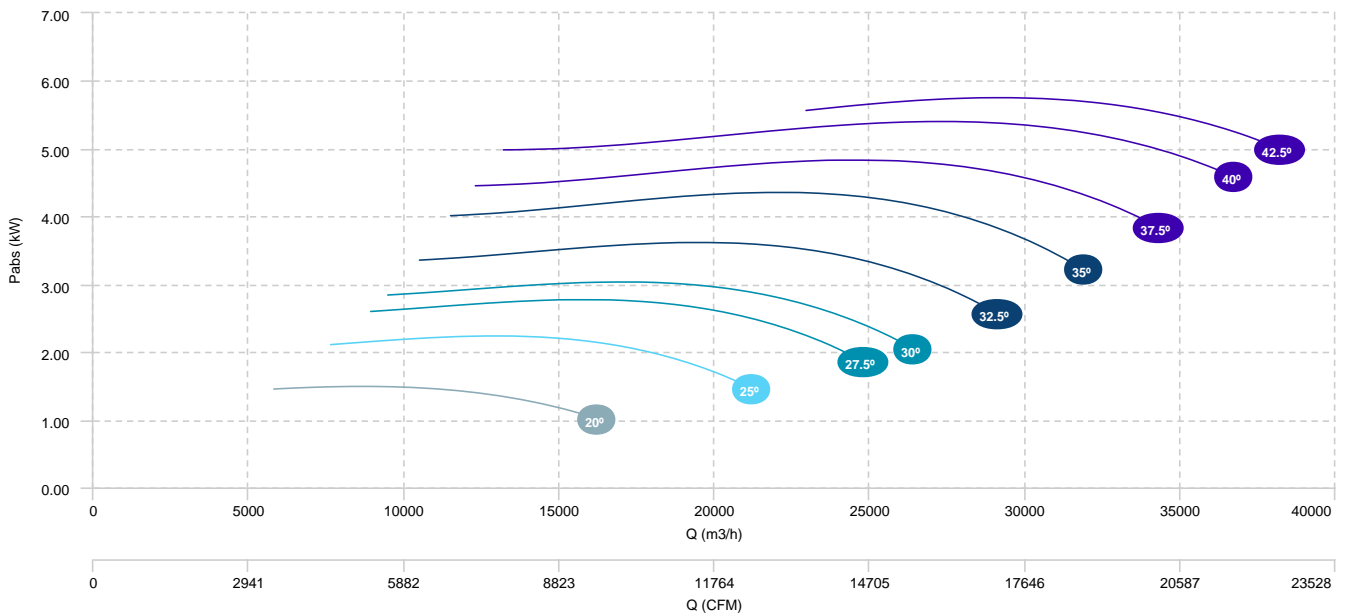

HBA 80 T4 1,1KW (A2:6)	HBA 80 T4 1,5KW (A2:6)	HBA 80 T4 2,2kW (A2:6)
HBA 80 T4 3kW (A2:6)	HBA 80 T4 4kW (A2:6)	HBA 80 T4 5,5kW (A2:6)

## AIR FLOW - PRESSURE

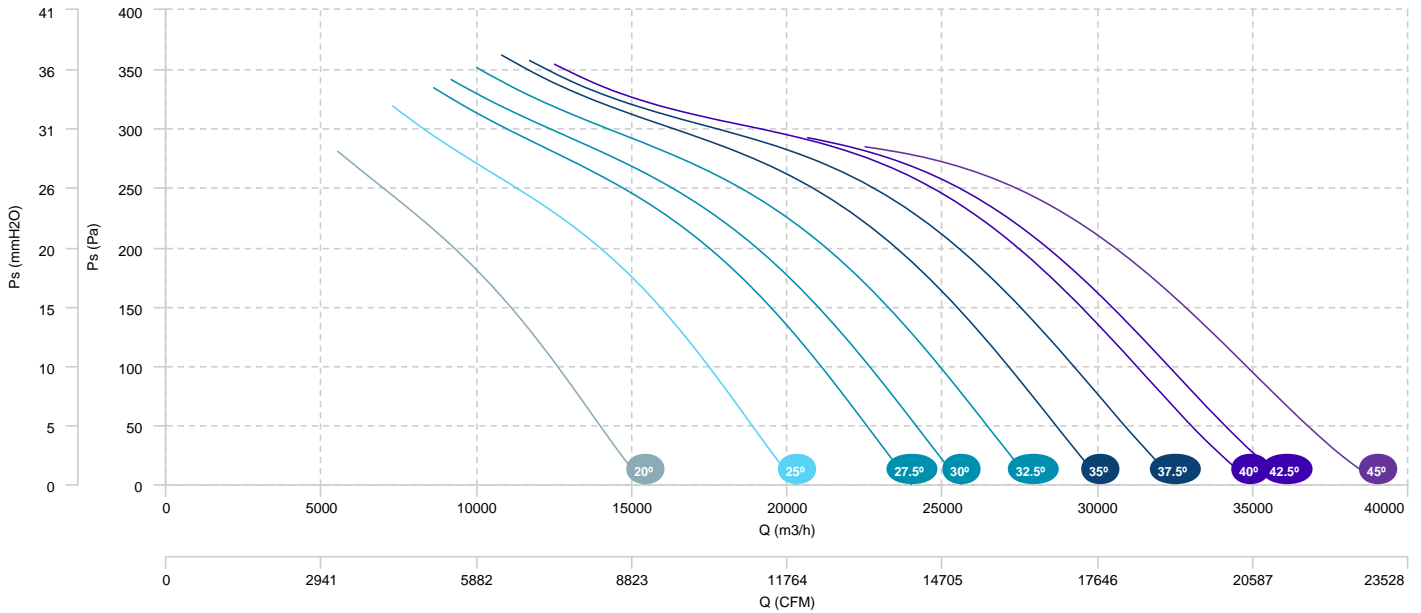

## AIR FLOW - ABSORBED POWER

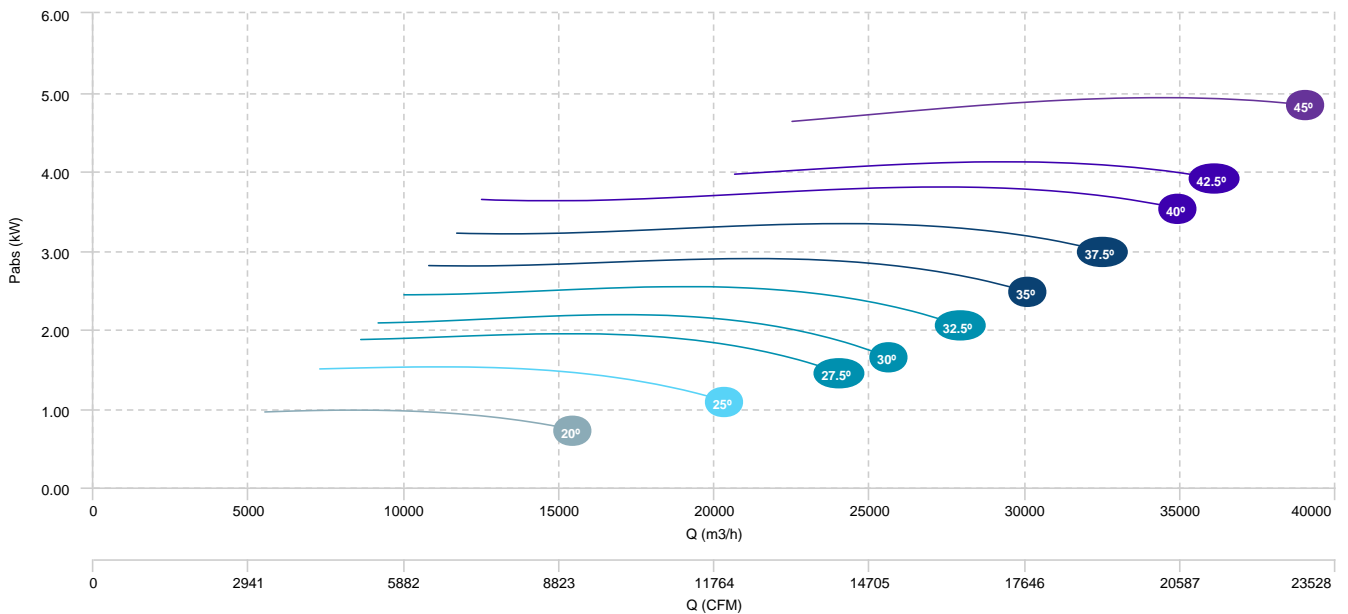

HBA 80 T6 0,75kW (A5:6)

HBA 80 T6 1,1kW (A5:6)

HBA 80 T6 1,5kW (A5:6)

HBA 80 T6 2,2kW (A5:6)

## AIR FLOW - PRESSURE

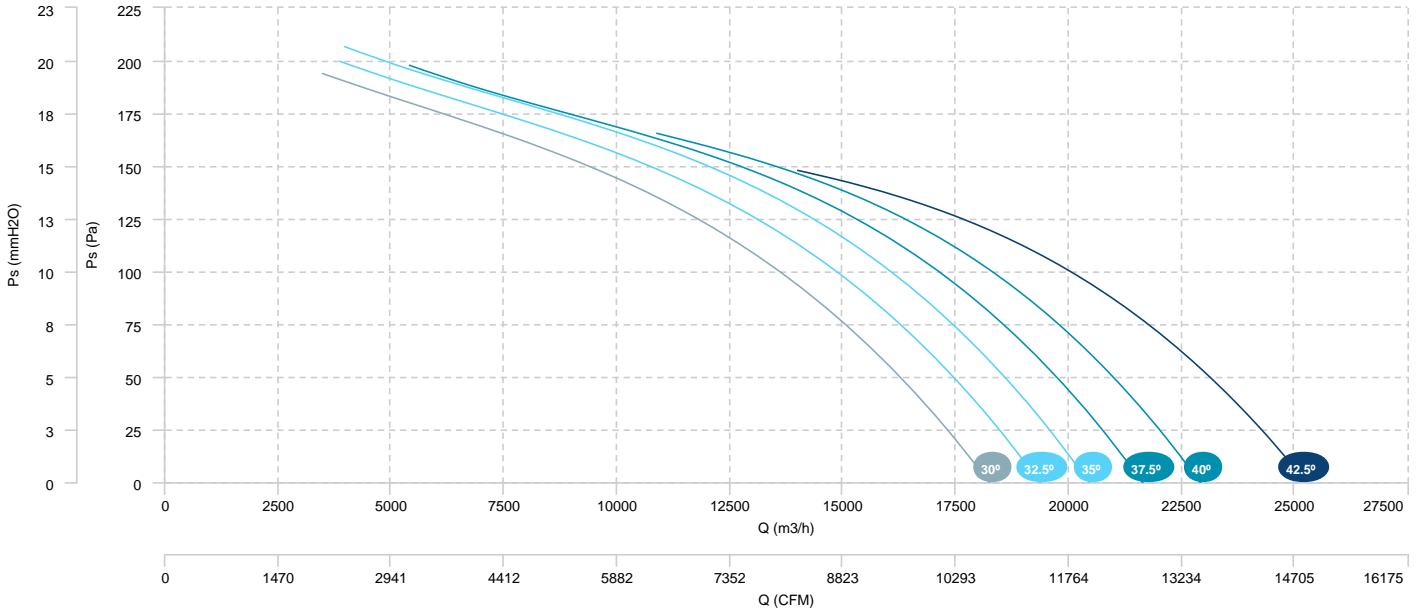

## AIR FLOW - ABSORBED POWER

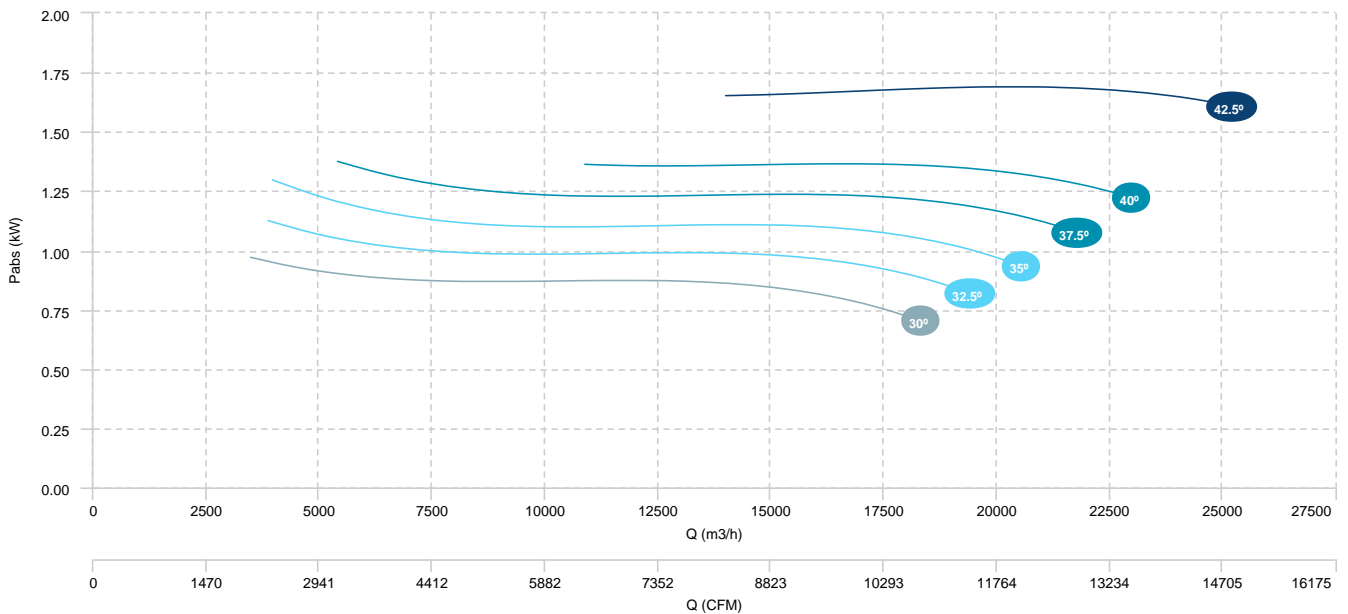

HBA 80 T6 0,75kW (A2:9)

HBA 80 T6 1,1kW (A2:9)

HBA 80 T6 1,5kW (A2:9)

HBA 80 T6 2,2kW (A2:9)

## AIR FLOW - PRESSURE

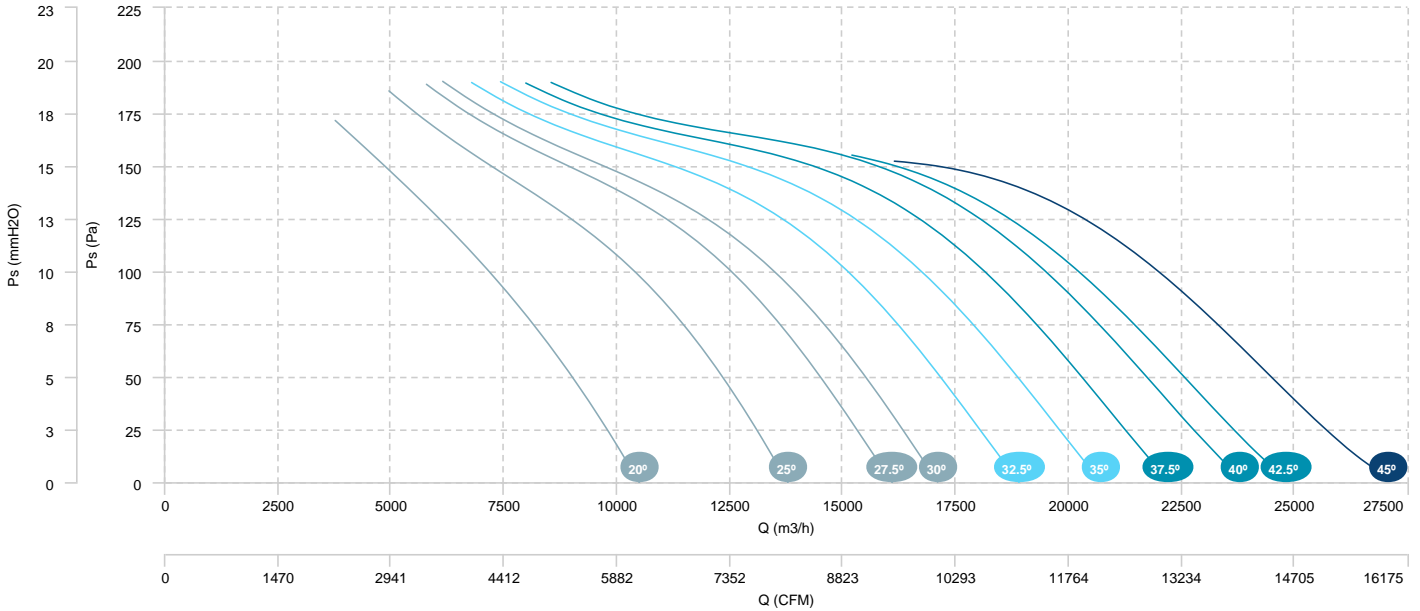

## AIR FLOW - ABSORBED POWER

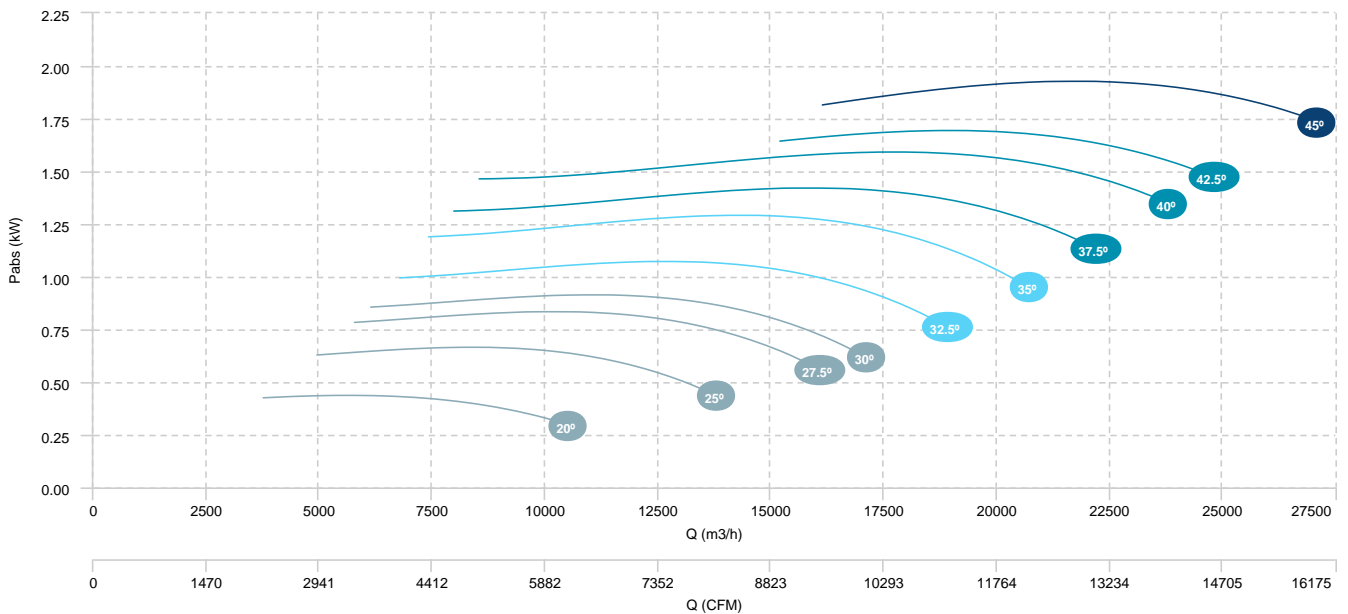

HBA 80 T6 0,75kW (A2:6)

HBA 80 T6 1,1kW (A2:6)

HBA 80 T6 1,5kW (A2:6)

## AIR FLOW - PRESSURE

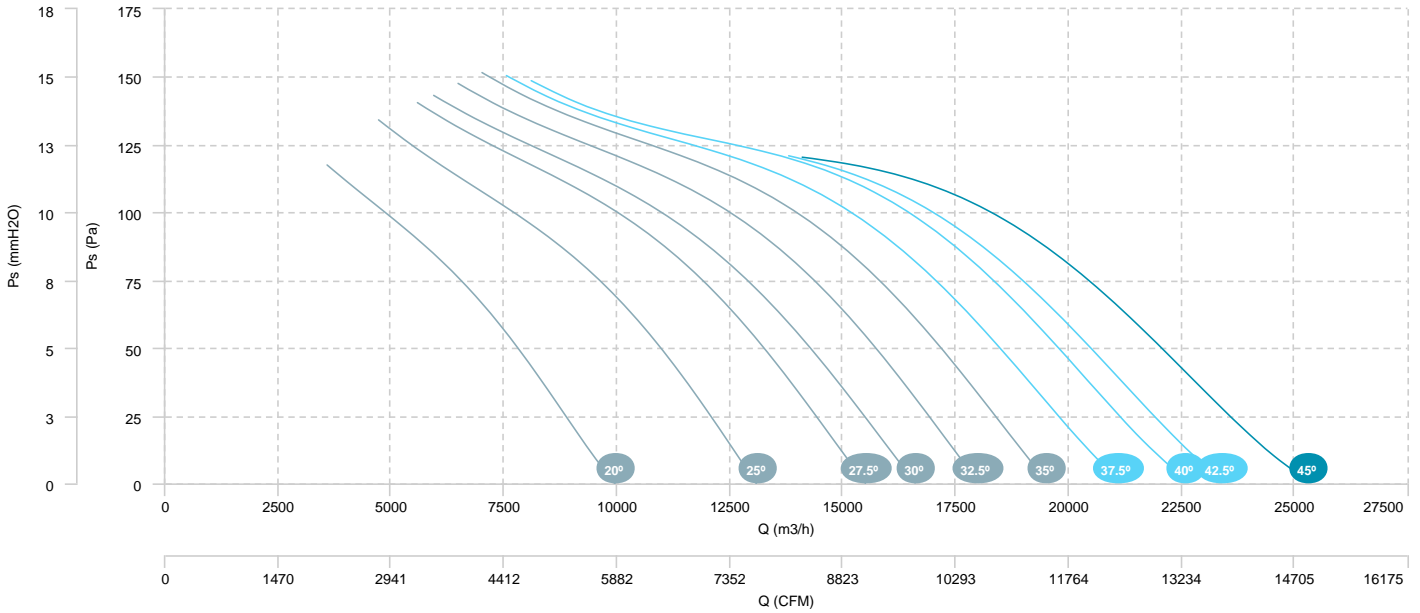

## AIR FLOW - ABSORBED POWER

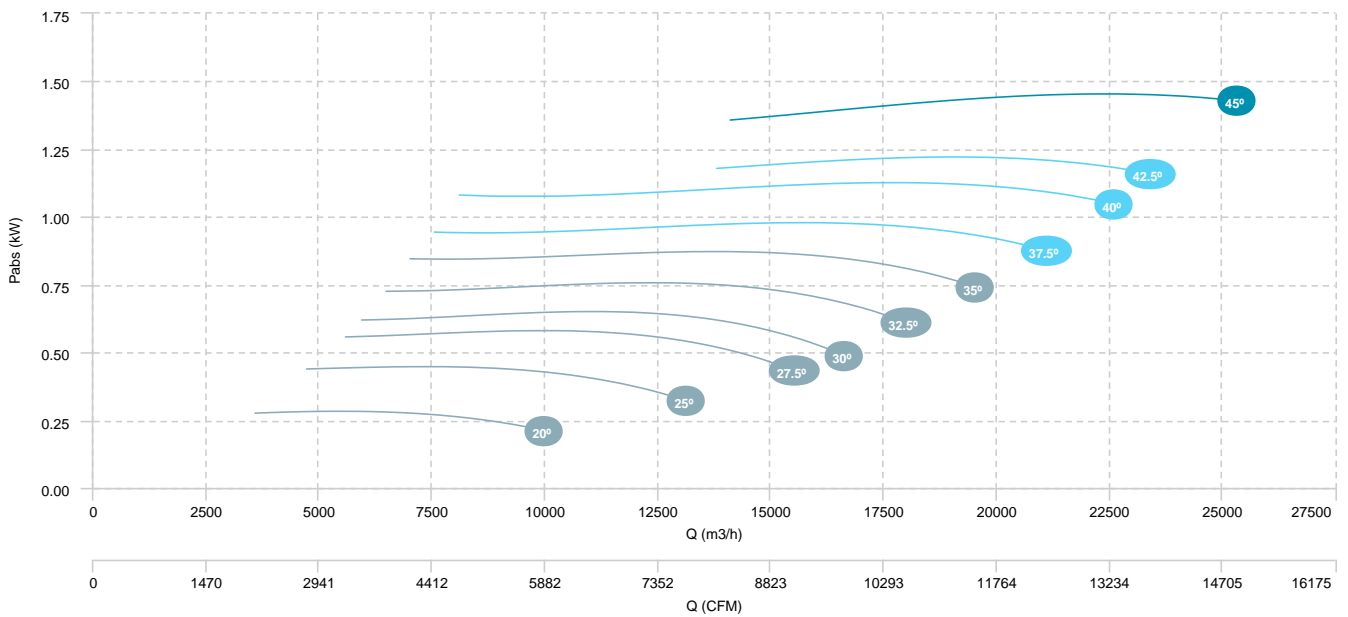

HBA 80 T4/T8 3/0,55kW (A5:6)

HBA 80 T4/T8 4/0,75kW (A5:6)

AIR FLOW - PRESSURE (4 poles)

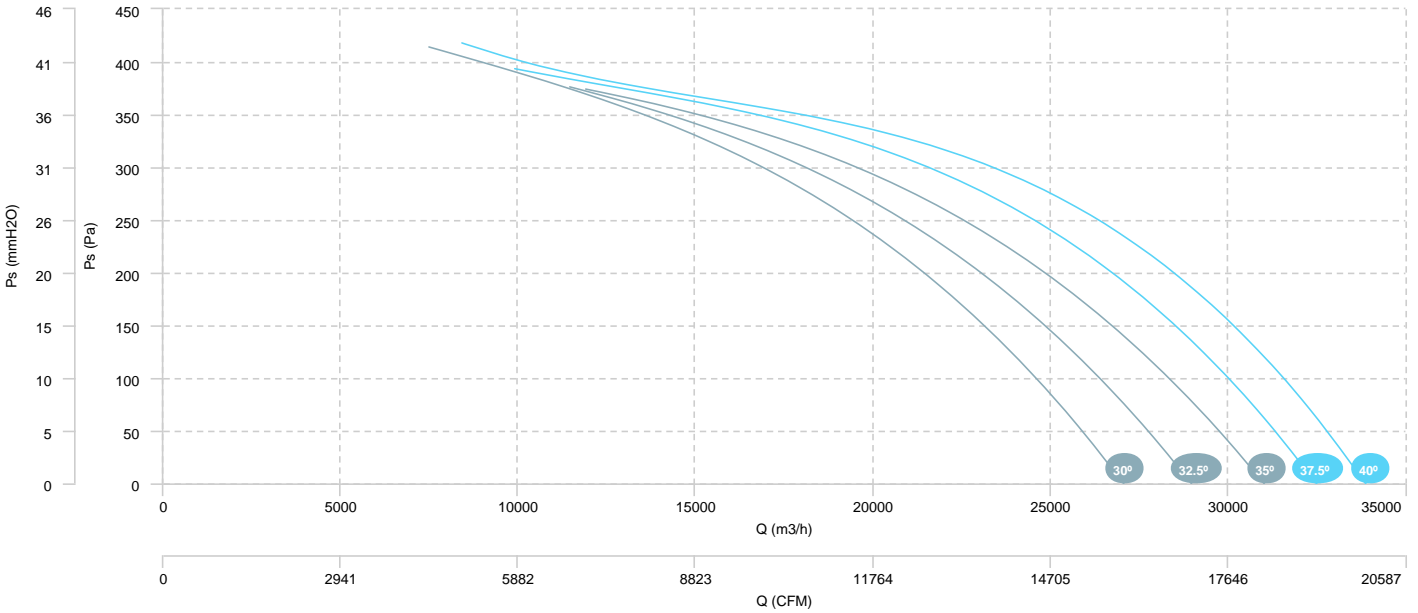

AIR FLOW - ABSORBED POWER (4 poles)

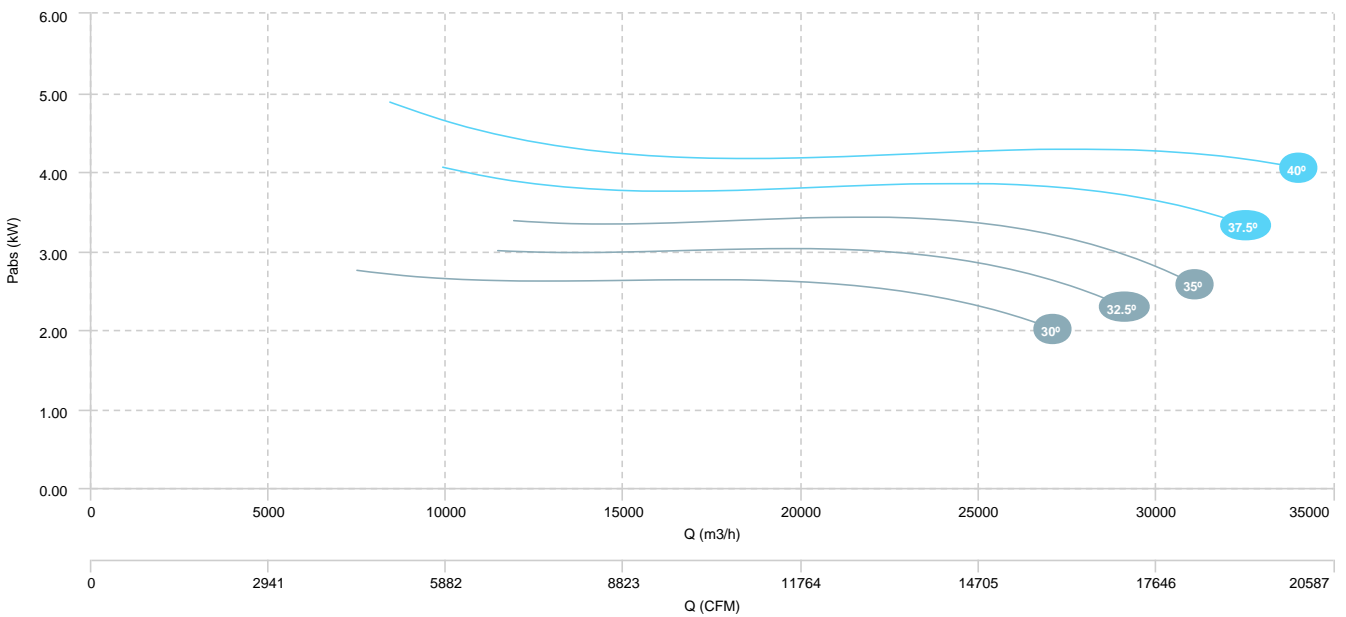



HBA 80 T4/T8 3/0,55kW (A5:6)

HBA 80 T4/T8 4/0,75kW (A5:6)

AIR FLOW - PRESSURE (8 poles)

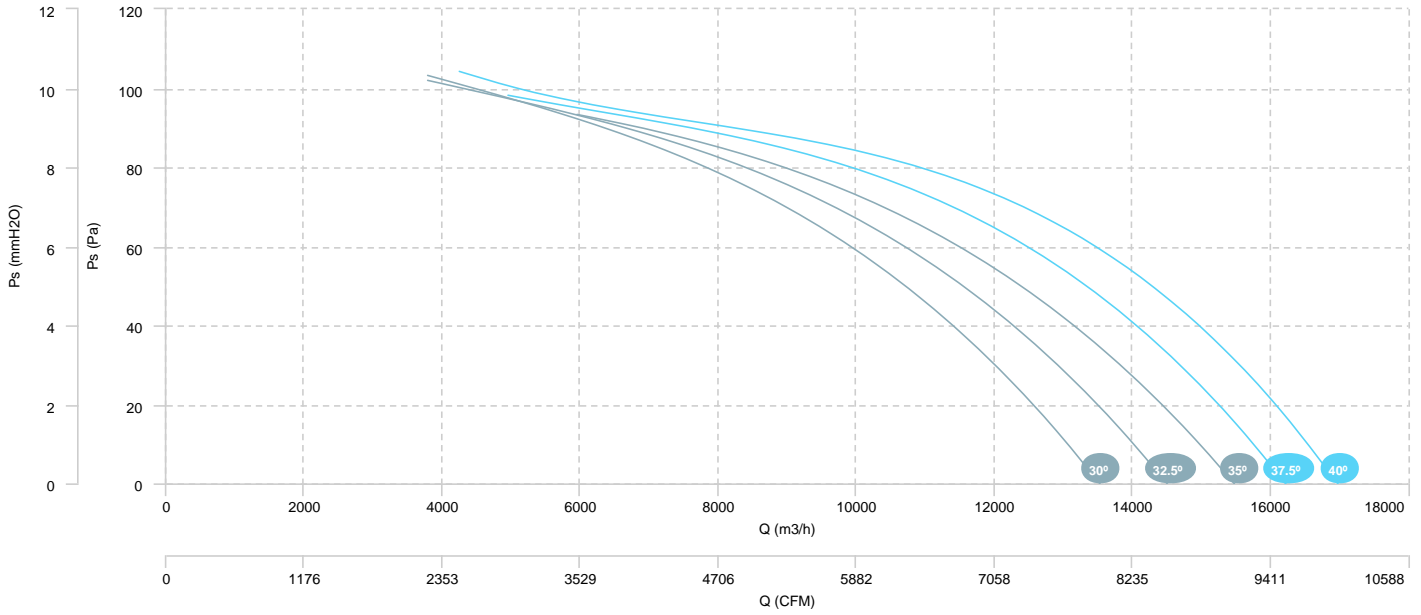

HBA 80 T4/T8 1,5/0,25kW (A2:9)	HBA 80 T4/T8 2,2/0,37kW (A2:9)	HBA 80 T4/T8 3/0,55kW (A2:9)
HBA 80 T4/T8 4/0,75kW (A2:9)	HBA 80 T4/T8 5,5/1,1kW (A2:9)	

## AIR FLOW - PRESSURE (4 poles)

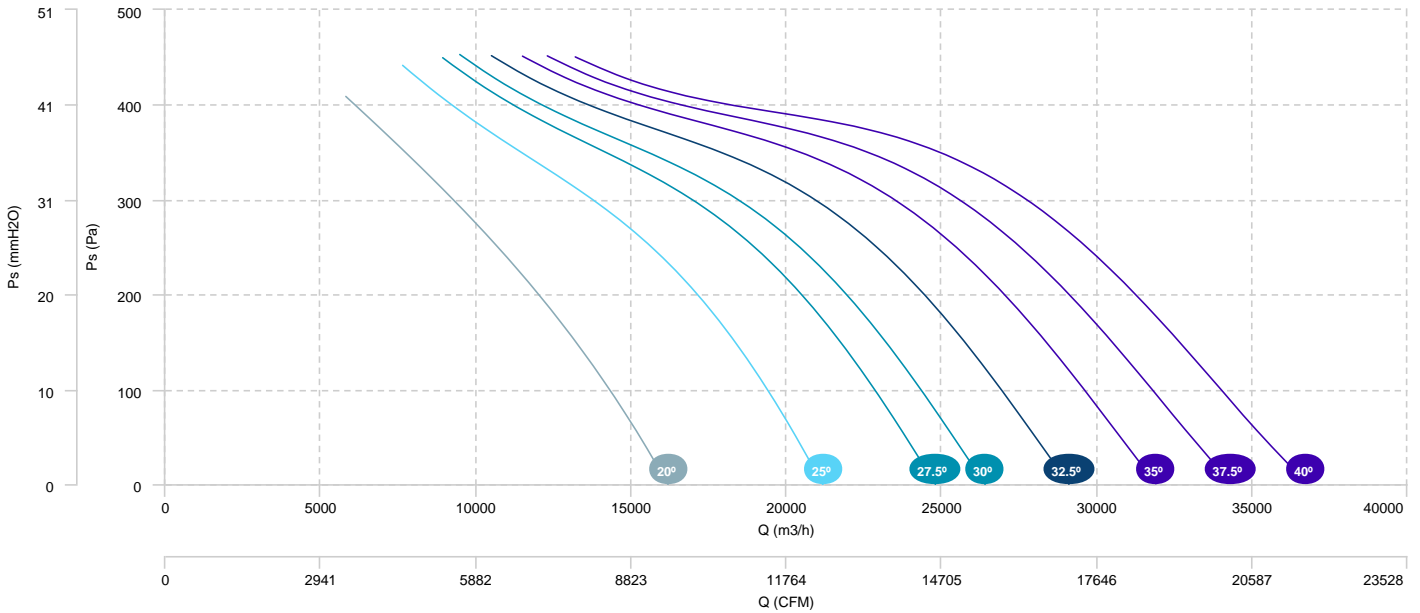

## AIR FLOW - ABSORBED POWER (4 poles)

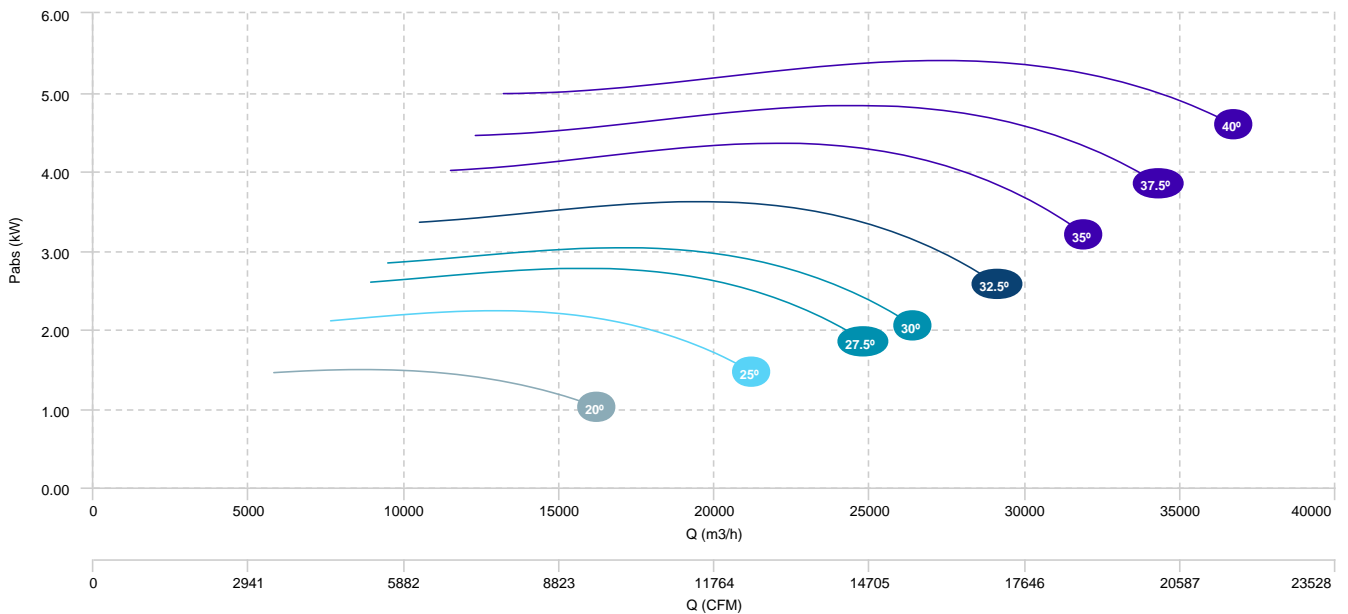

HBA 80 T4/T8 1,5/0,25kW (A2:9)	HBA 80 T4/T8 2,2/0,37kW (A2:9)	HBA 80 T4/T8 3/0,55kW (A2:9)
HBA 80 T4/T8 4/0,75kW (A2:9)	HBA 80 T4/T8 5,5/1,1kW (A2:9)	

## AIR FLOW - PRESSURE (8 poles)

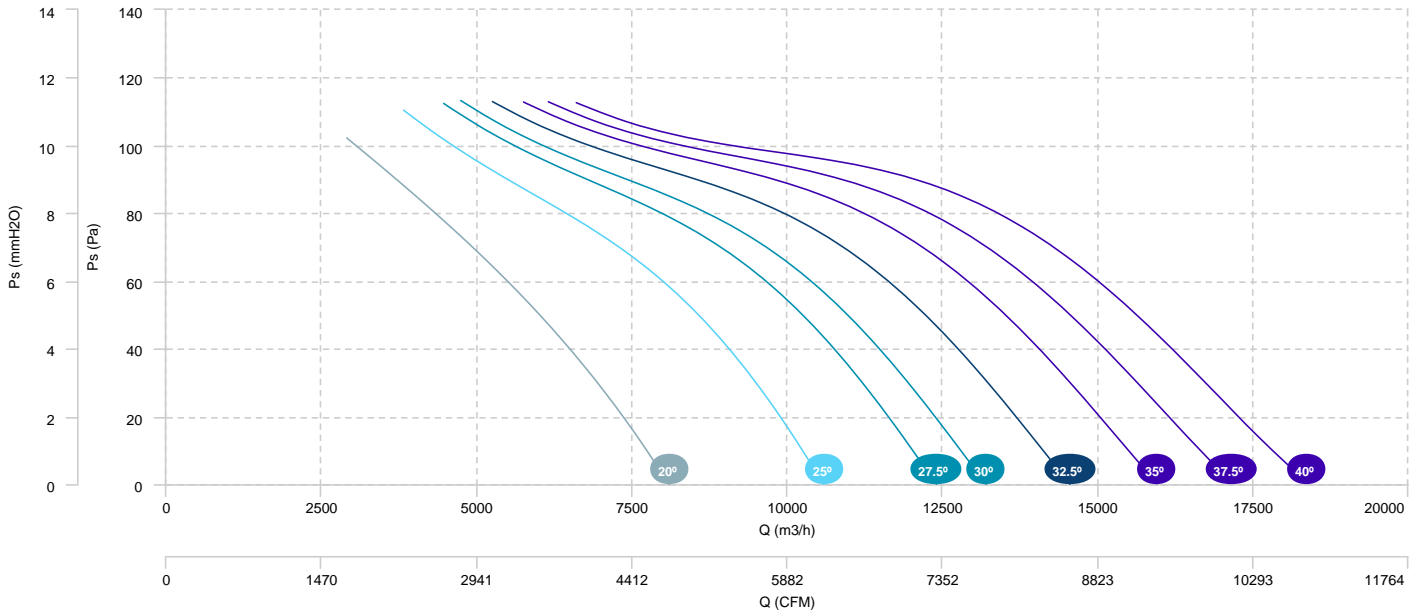

HBA 80 T4/T8 1,1/0,18kW (A2:6)	HBA 80 T4/T8 1,5/0,25kW (A2:6)	HBA 80 T4/T8 2,2/0,37kW (A2:6)
HBA 80 T4/T8 3/0,55kW (A2:6)	HBA 80 T4/T8 4/0,75kW (A2:6)	HBA 80 T4/T8 5,5/1,1kW (A2:6)

## AIR FLOW - PRESSURE (4 poles)

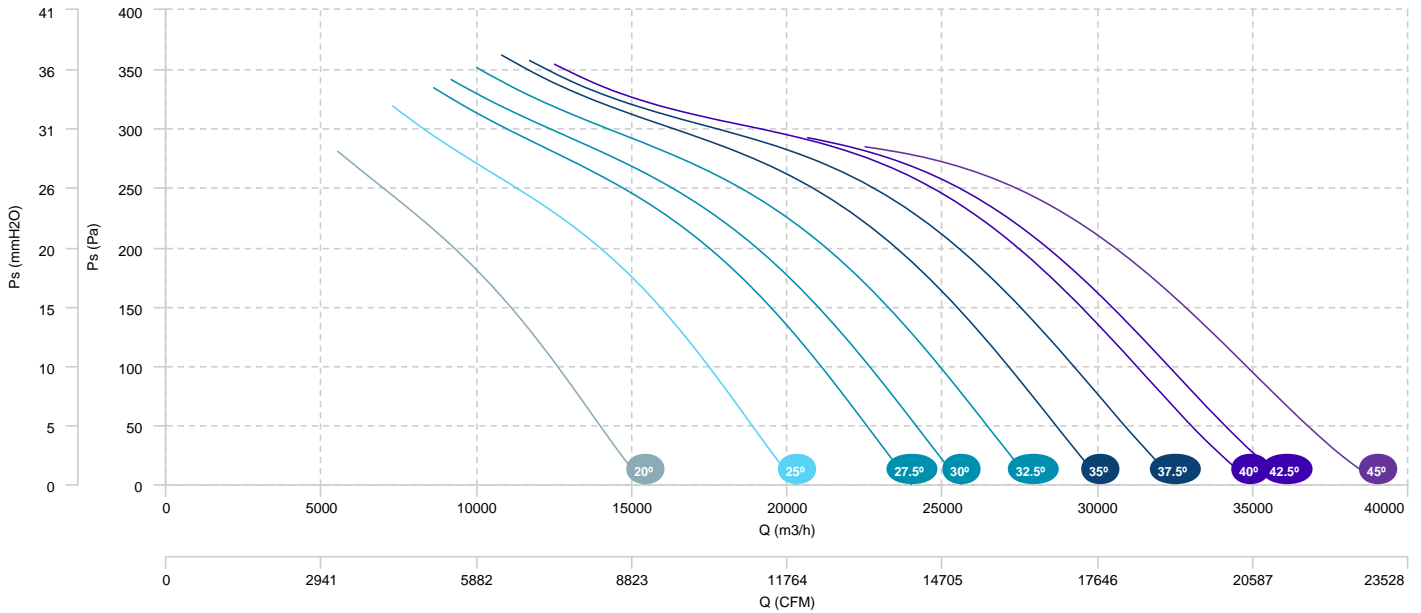

## AIR FLOW - ABSORBED POWER (4 poles)

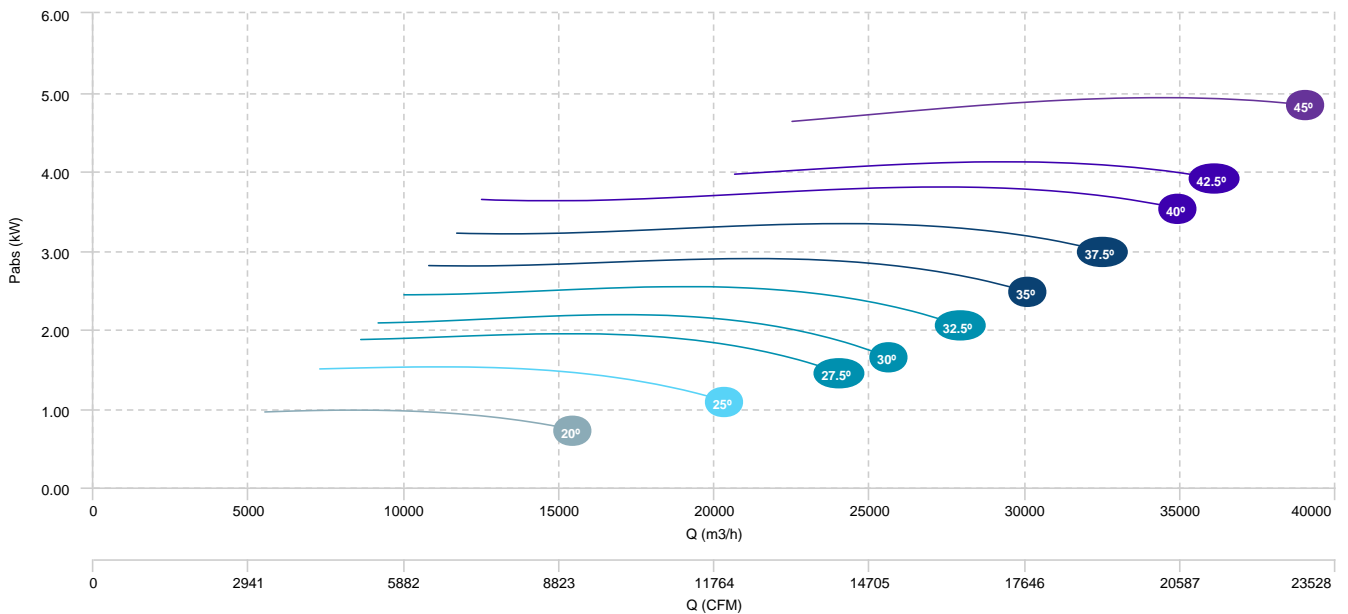

HBA 80 T4/T8 1,1/0,18kW (A2:6)	HBA 80 T4/T8 1,5/0,25kW (A2:6)	HBA 80 T4/T8 2,2/0,37kW (A2:6)
HBA 80 T4/T8 3/0,55kW (A2:6)	HBA 80 T4/T8 4/0,75kW (A2:6)	HBA 80 T4/T8 5,5/1,1kW (A2:6)

## AIR FLOW - PRESSURE (8 poles)

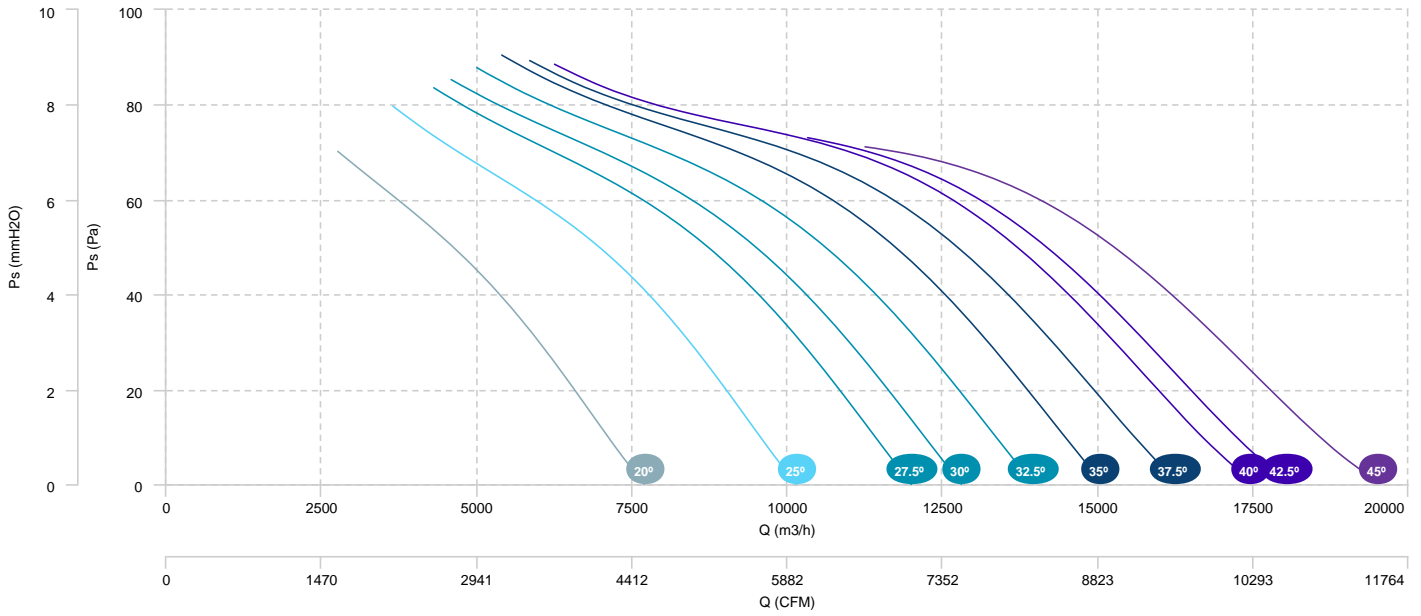

HBA 90 T4 5,5kW (A6:6)	HBA 90 T4 7,5kW (A6:6)	HBA 90 T4 11kW (A6:6)
HBA 90 T4 15kW (A6:6)		

## AIR FLOW - PRESSURE

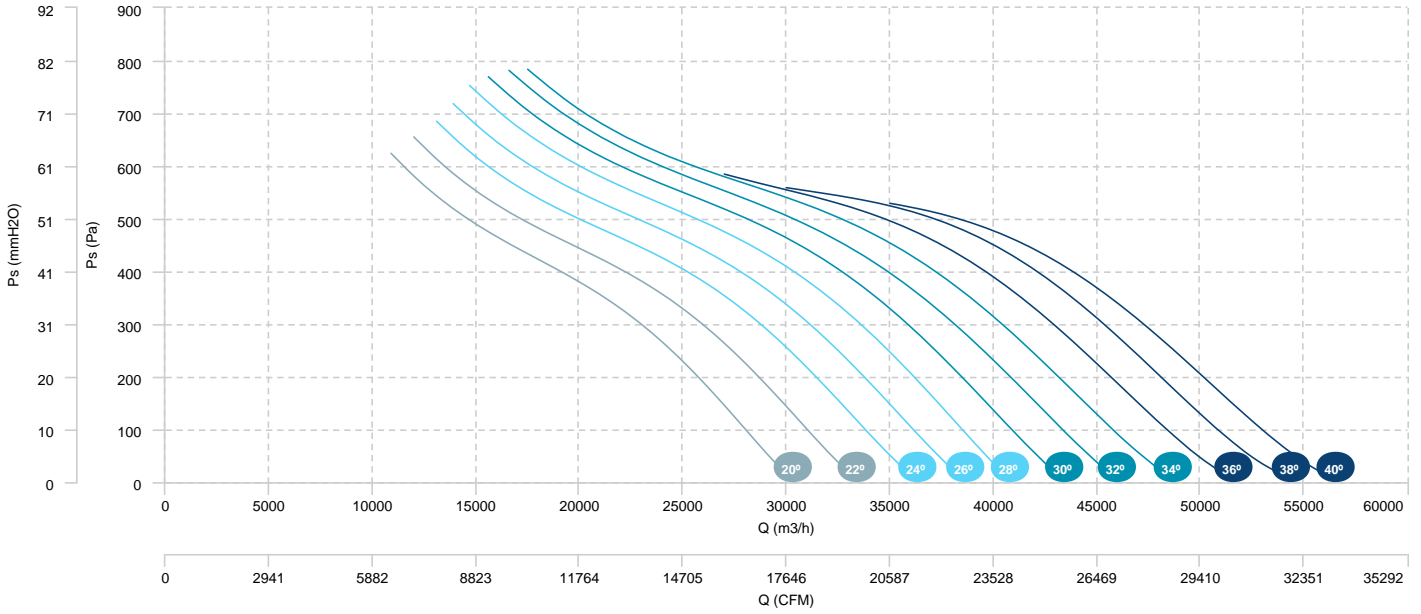

## AIR FLOW - ABSORBED POWER

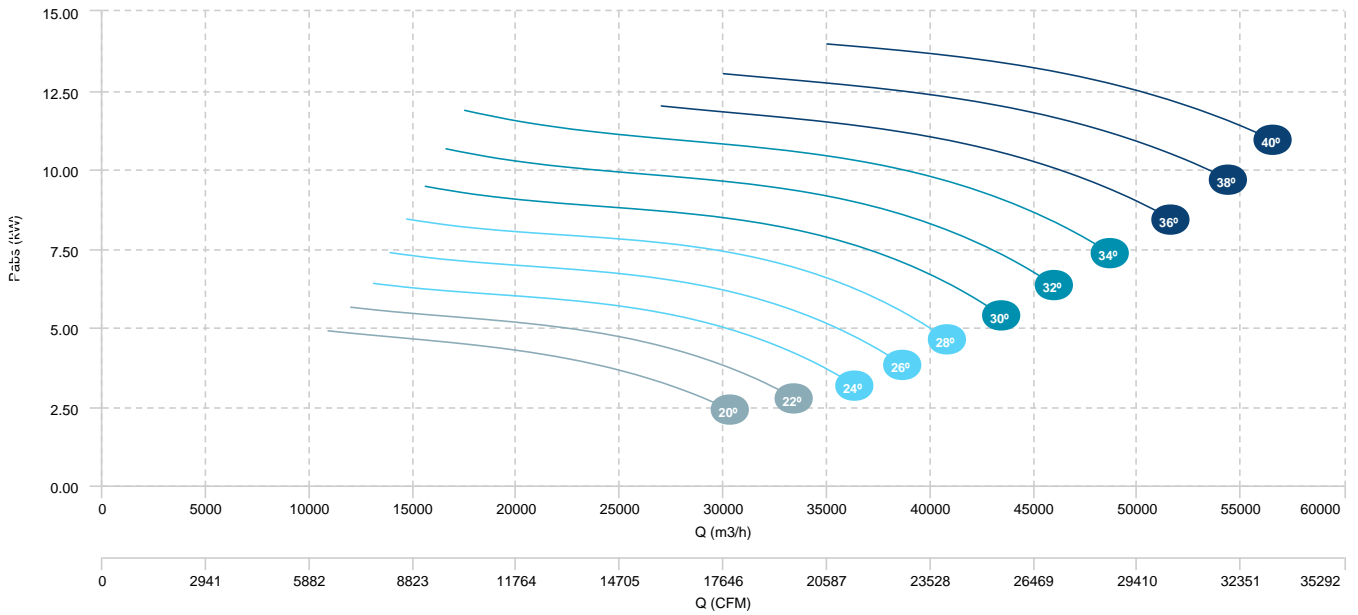

HBA 90 T4 3kW (A6:3)	HBA 90 T4 4kW (A6:3)	HBA 90 T4 5,5kW (A6:3)
HBA 90 T4 7,5kW (A6:3)	HBA 90 T4 11kW (A6:3)	

## AIR FLOW - PRESSURE

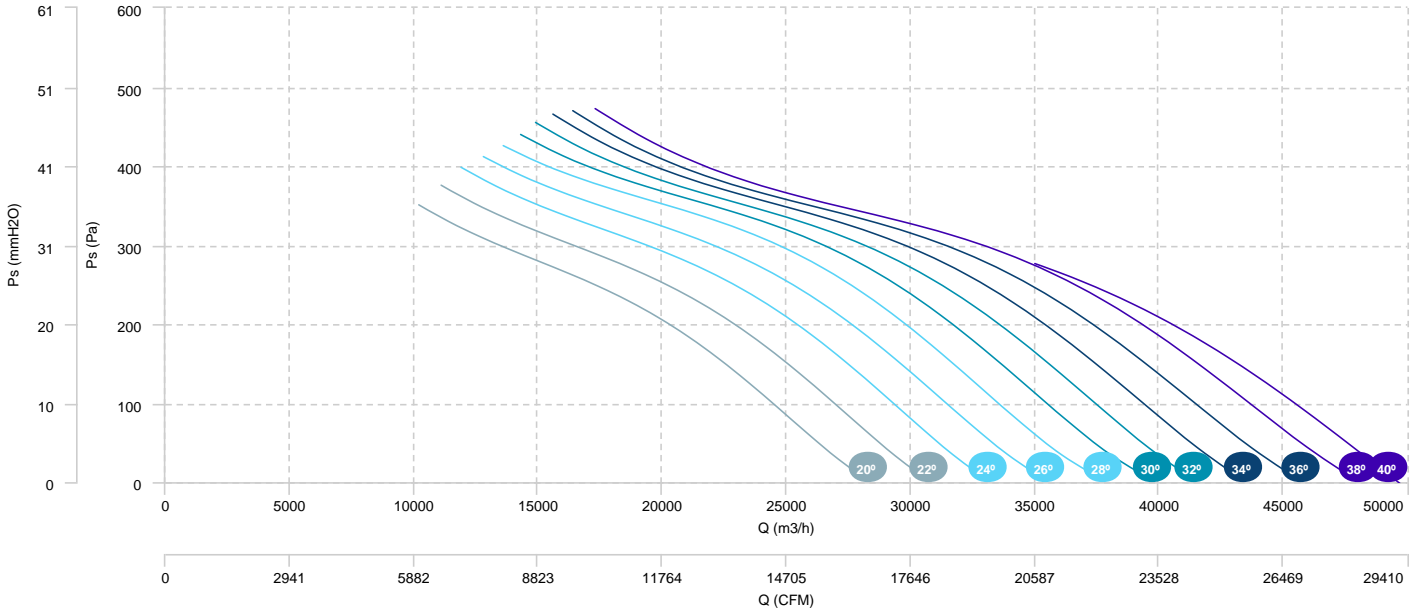

## AIR FLOW - ABSORBED POWER

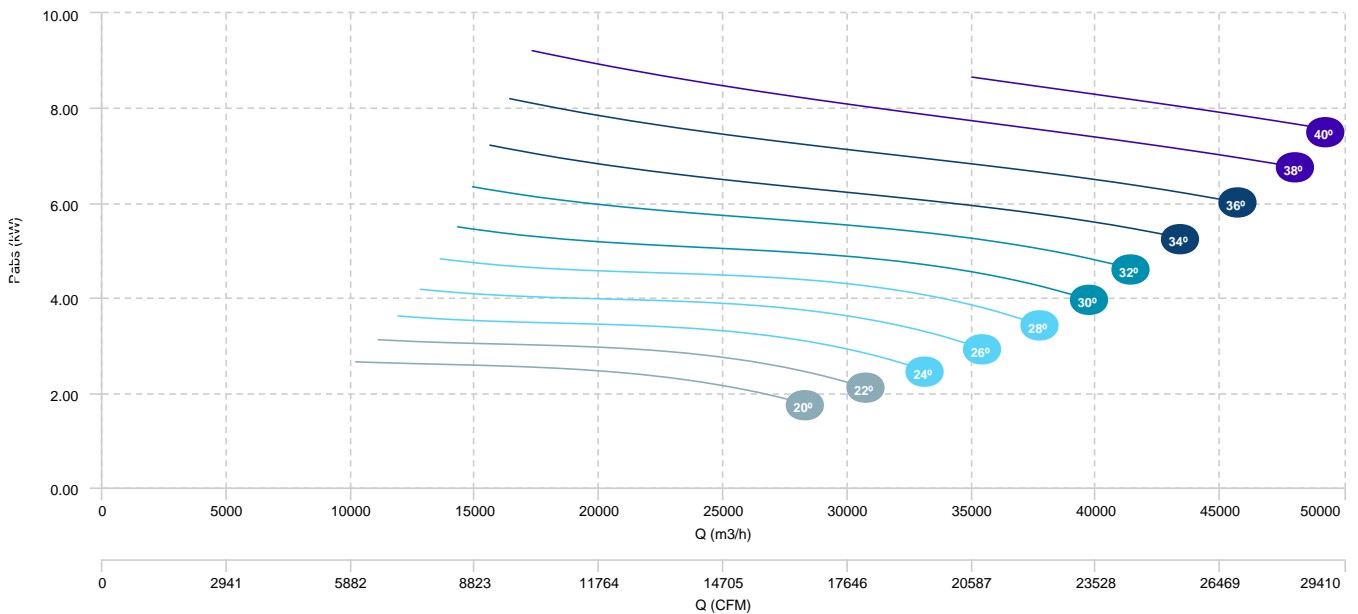

HBA 90 T6 1,5kW (A6:3)

HBA 90 T6 2,2kW (A6:3)

HBA 90 T6 3kW (A6:3)

## AIR FLOW - PRESSURE

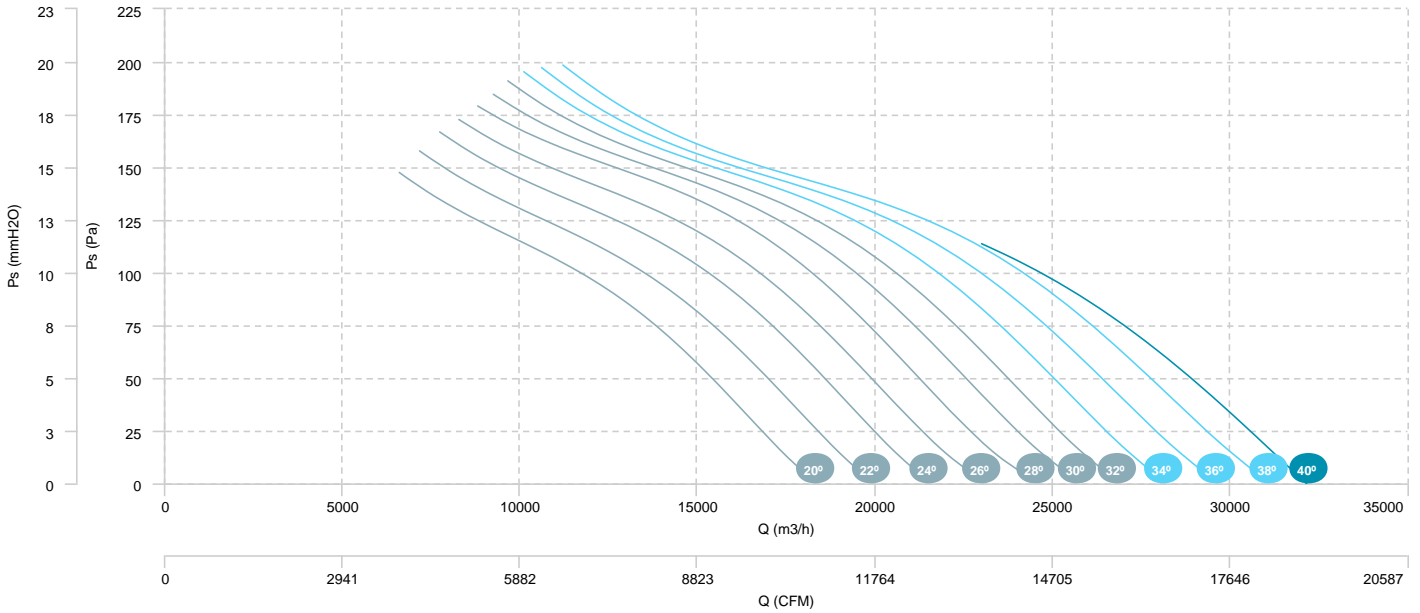

## AIR FLOW - ABSORBED POWER

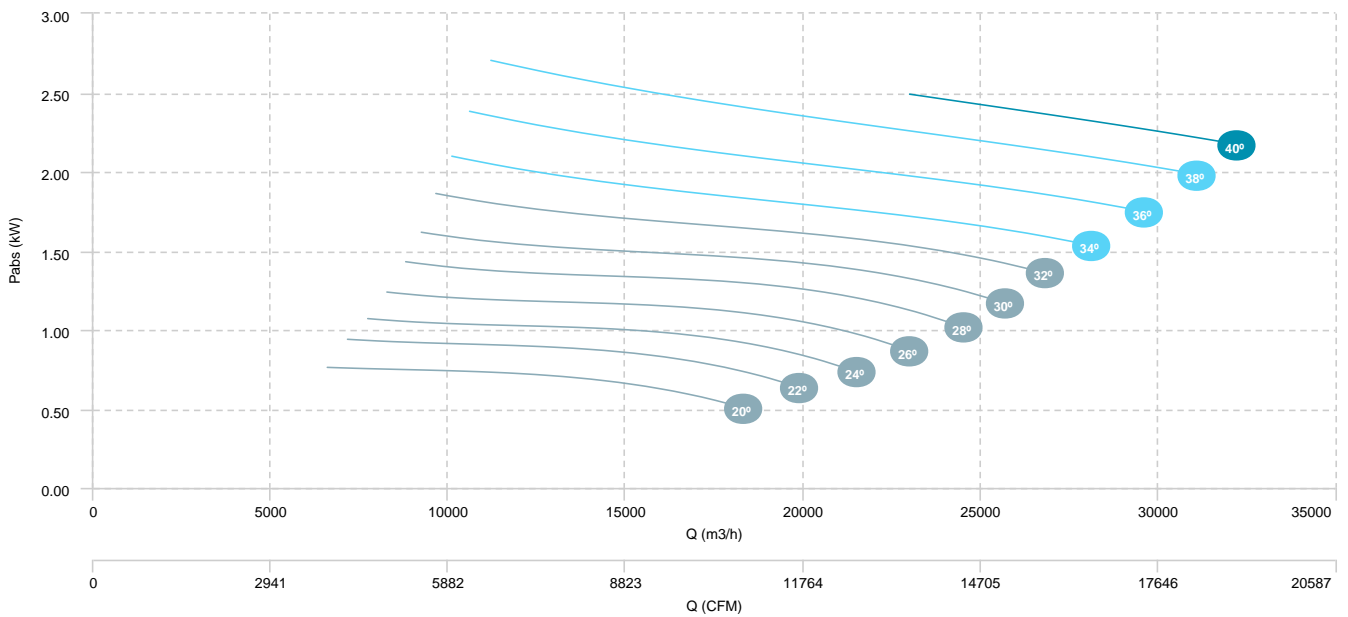



HBA 90 T6 1,5kW (A6:6)	HBA 90 T6 2,2kW (A6:6)	HBA 90 T6 3kW (A6:6)
HBA 90 T6 4kW (A6:6)		

## AIR FLOW - PRESSURE

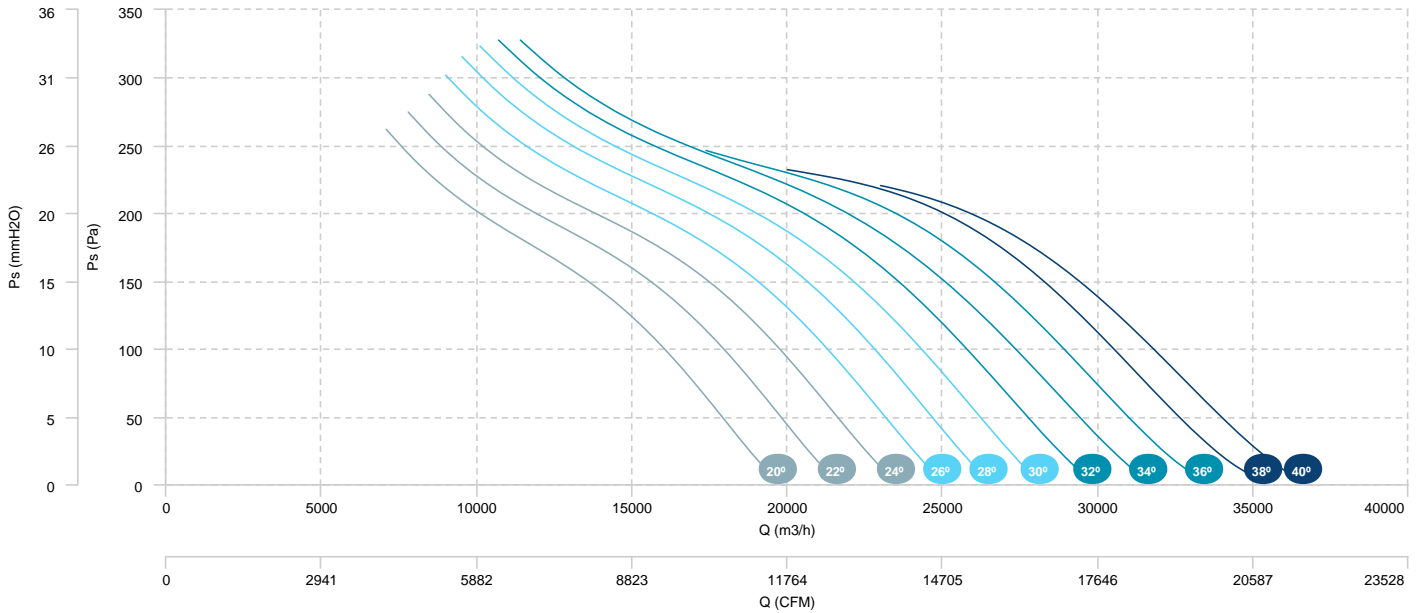

## AIR FLOW - ABSORBED POWER

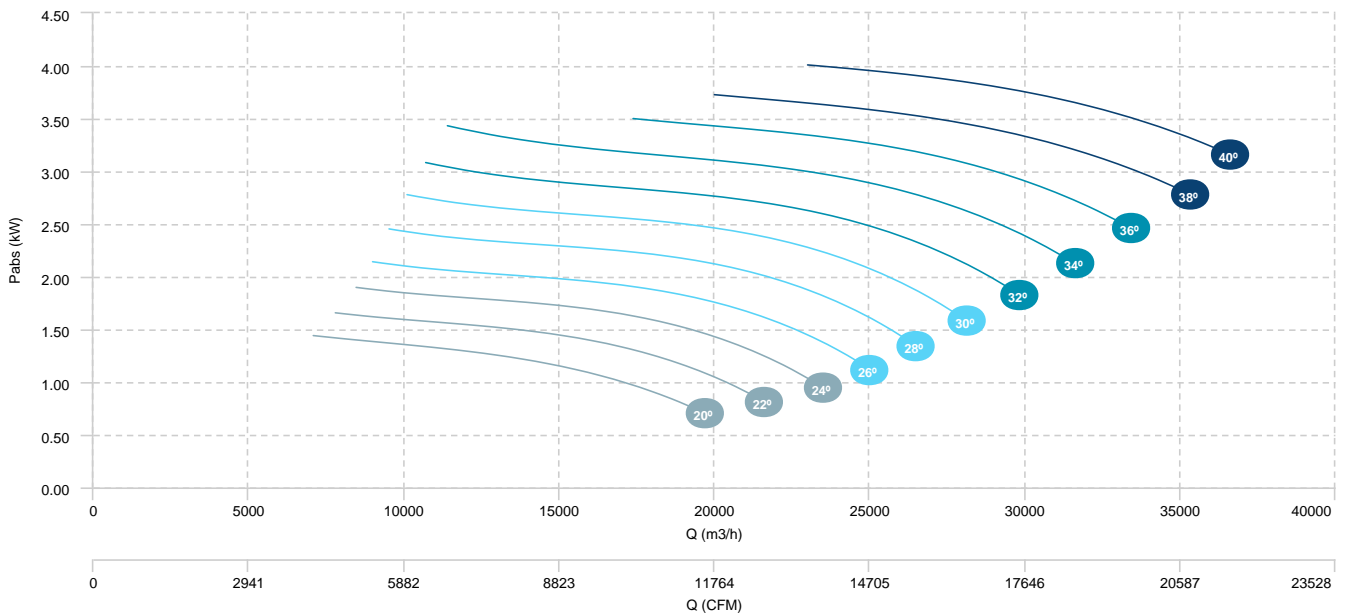

HBA 90 T4/T8 5,5/1,1kW (A6:6)

HBA 90 T4/T8 7,5/1,5kW (A6:6)

HBA 90 T4/T8 11/3kW (A6:6)

HBA 90 T4/T8 15/3,5kW (A6:6)

## AIR FLOW - PRESSURE (4 poles)

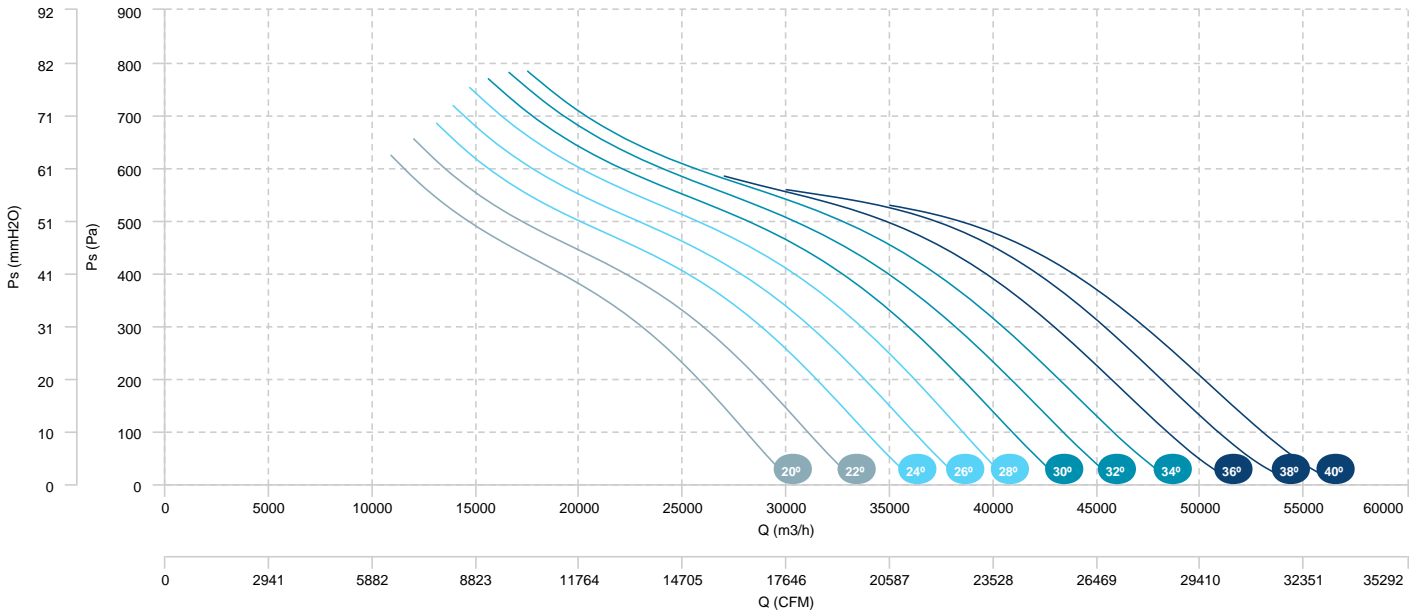

## AIR FLOW - ABSORBED POWER (4 poles)

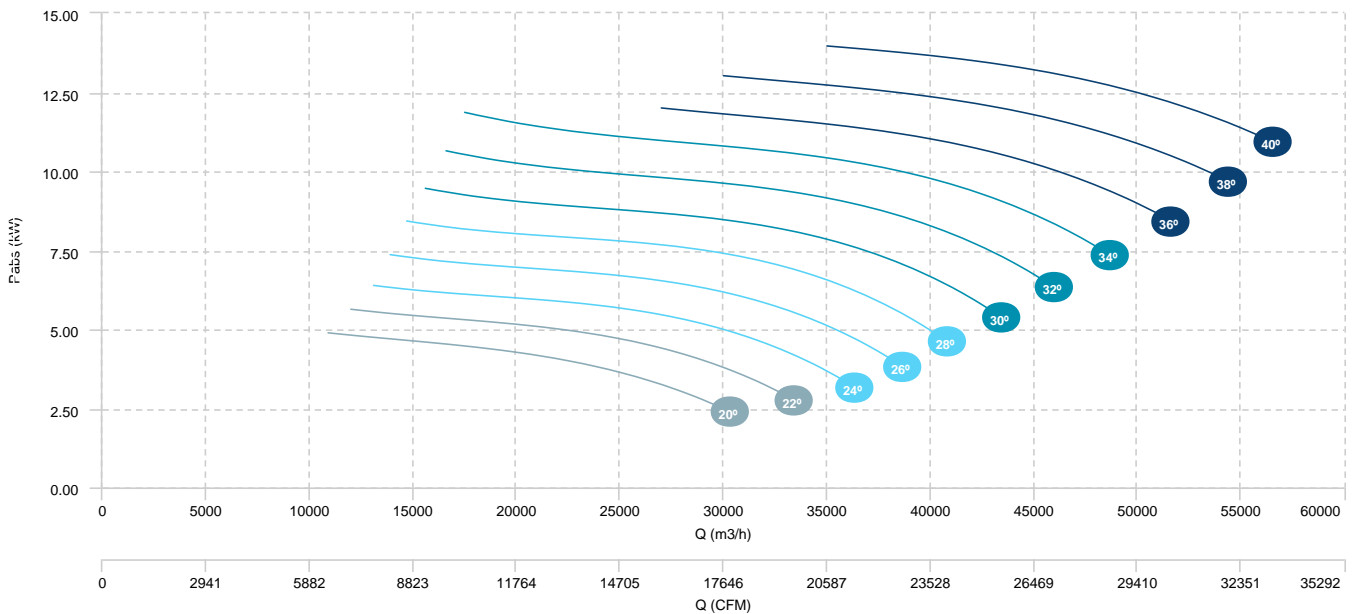

HBA 90 T4/T8 5,5/1,1kW (A6:6)	HBA 90 T4/T8 7,5/1,5kW (A6:6)	HBA 90 T4/T8 11/3kW (A6:6)
HBA 90 T4/T8 15/3,5kW (A6:6)		

## AIR FLOW - PRESSURE (8 poles)

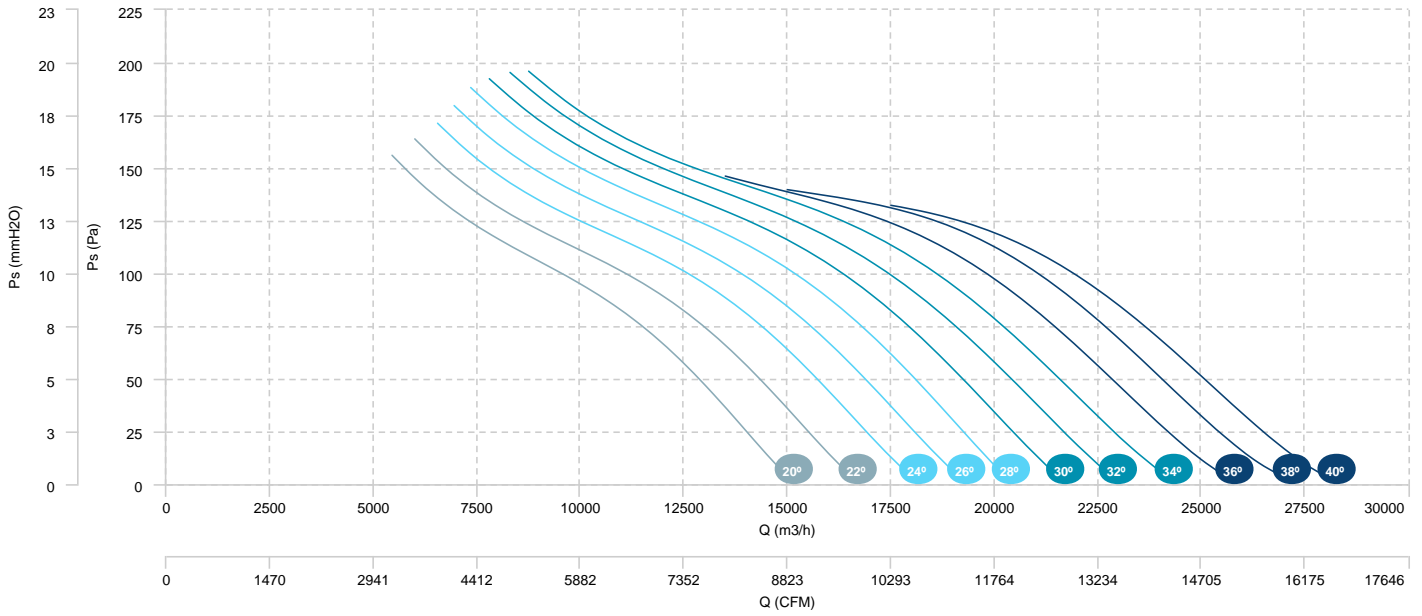

HBA 90 T4/T8 3/0,55kW (A6:3)	HBA 90 T4/T8 4/0,75kW (A6:3)	HBA 90 T4/T8 5,5/1,1kW (A6:3)
HBA 90 T4/T8 7,5/1,5kW (A6:3)	HBA 90 T4/T8 11/3kW (A6:3)	

AIR FLOW - PRESSURE (4 poles)

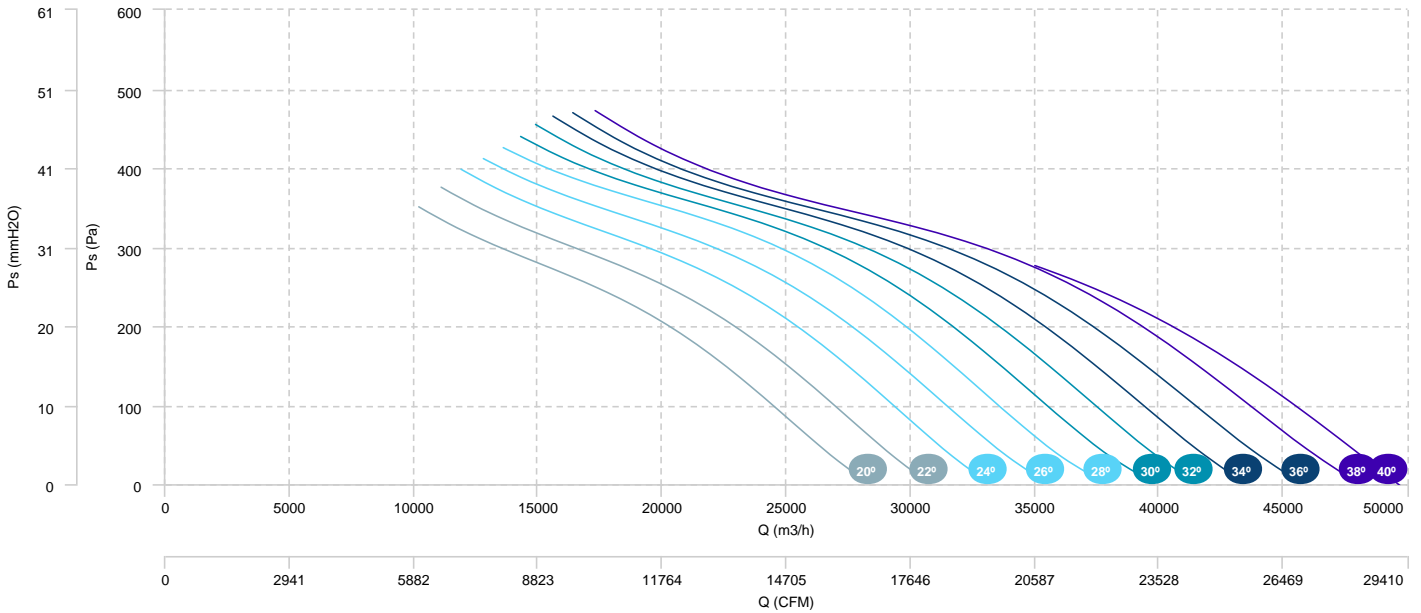

AIR FLOW - ABSORBED POWER (4 poles)

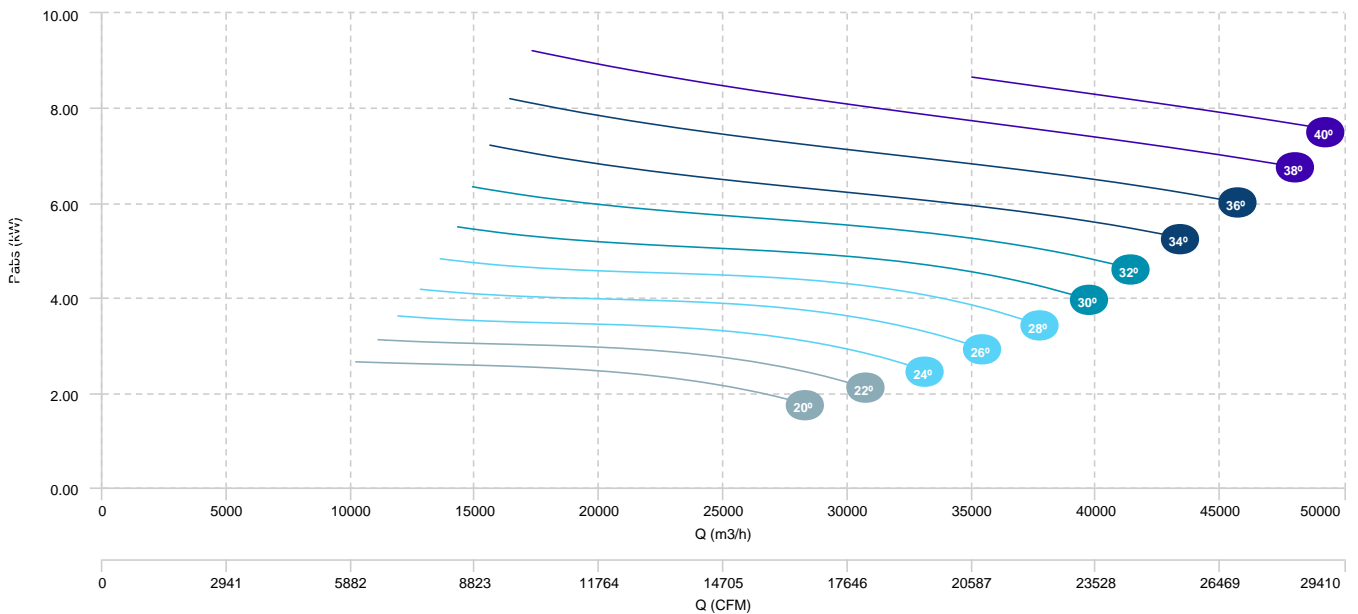

HBA 90 T4/T8 3/0,55kW (A6:3)	HBA 90 T4/T8 4/0,75kW (A6:3)	HBA 90 T4/T8 5,5/1,1kW (A6:3)
HBA 90 T4/T8 7,5/1,5kW (A6:3)	HBA 90 T4/T8 11/3kW (A6:3)	

## AIR FLOW - PRESSURE (8 poles)

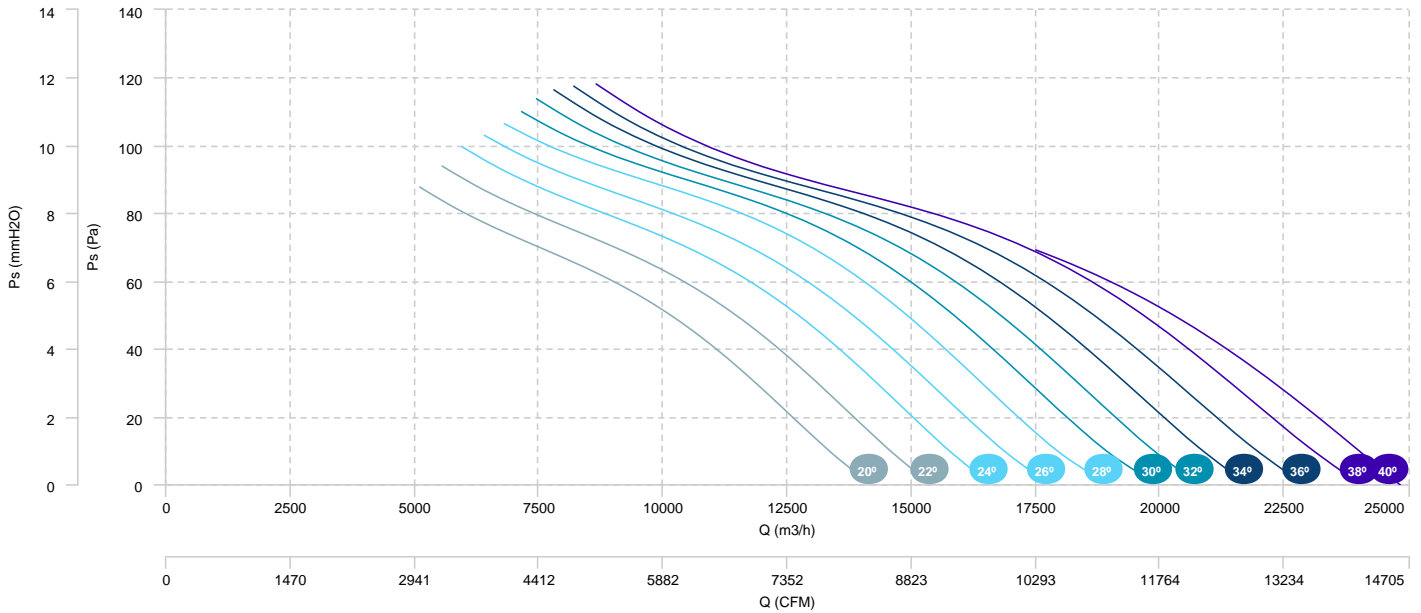

HBA 100 T4 5,5kW (A6:3)	HBA 100 T4 7,5kW (A6:3)	HBA 100 T4 11kW (A6:3)
HBA 100 T4 15kW (A6:3)		

## AIR FLOW - PRESSURE

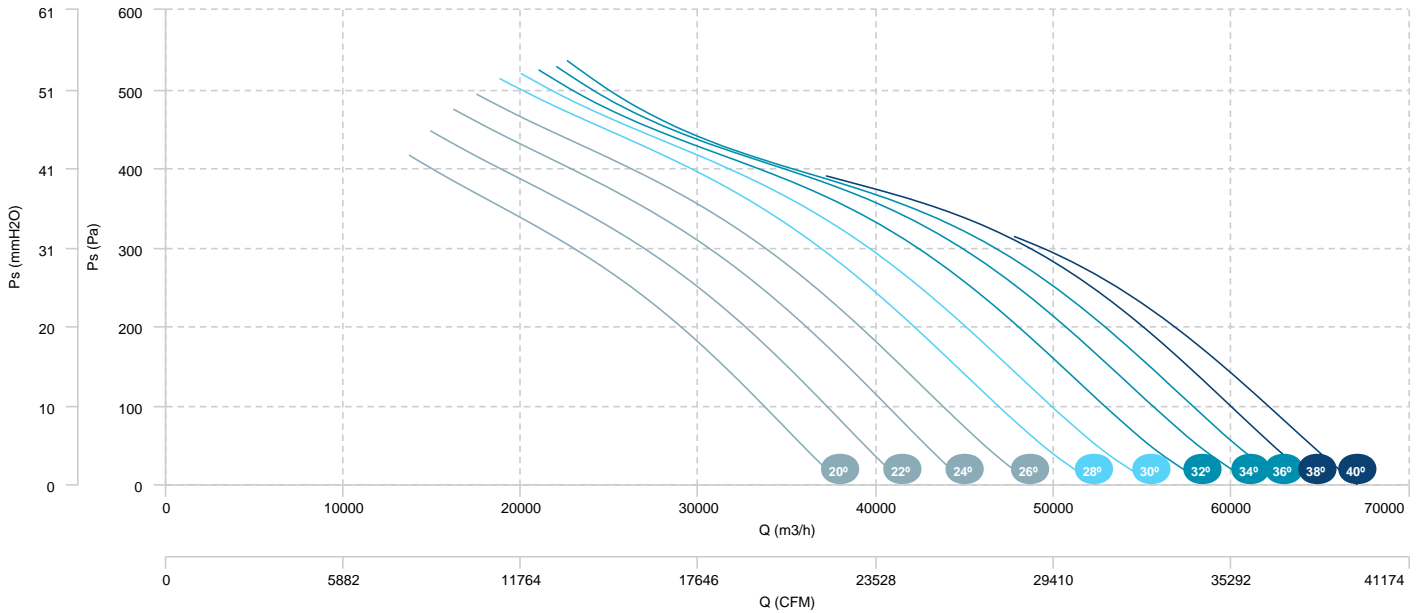

## AIR FLOW - ABSORBED POWER

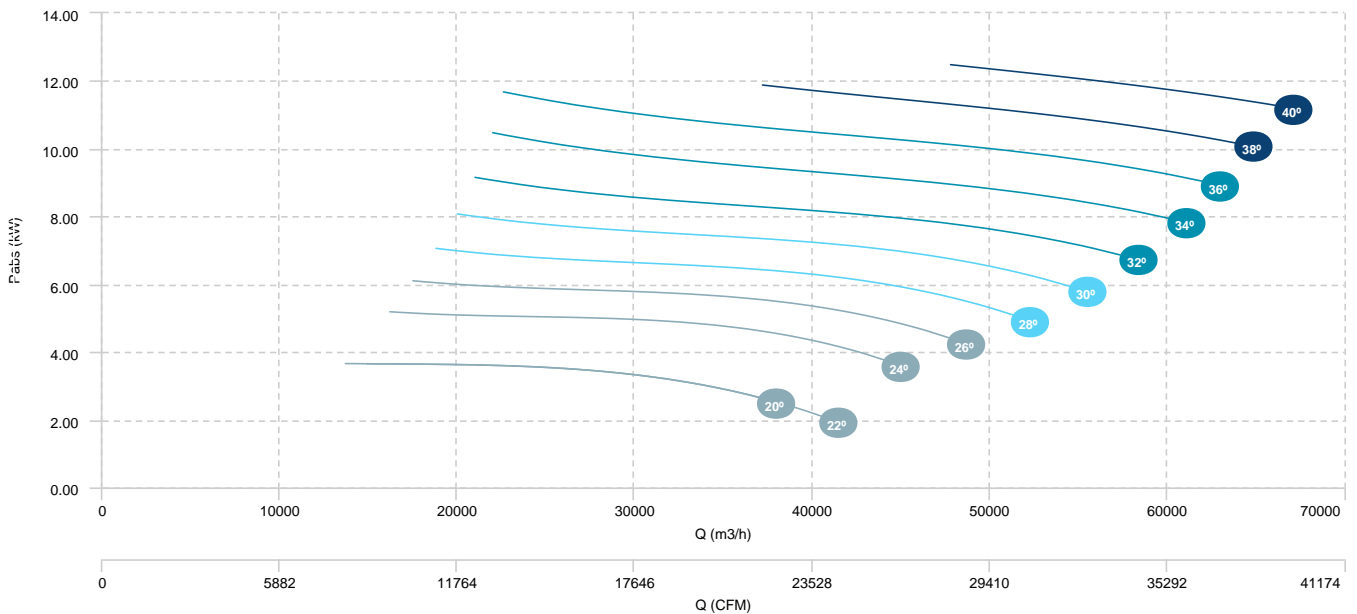

HBA 100 T4 7,5kW (A6:6)	HBA 100 T4 11kW (A6:6)	HBA 100 T4 15kW (A6:6)
HBA 100 T4 18,5kW (A6:6)	HBA 100 T4 22kW (A6:6)	

## AIR FLOW - PRESSURE

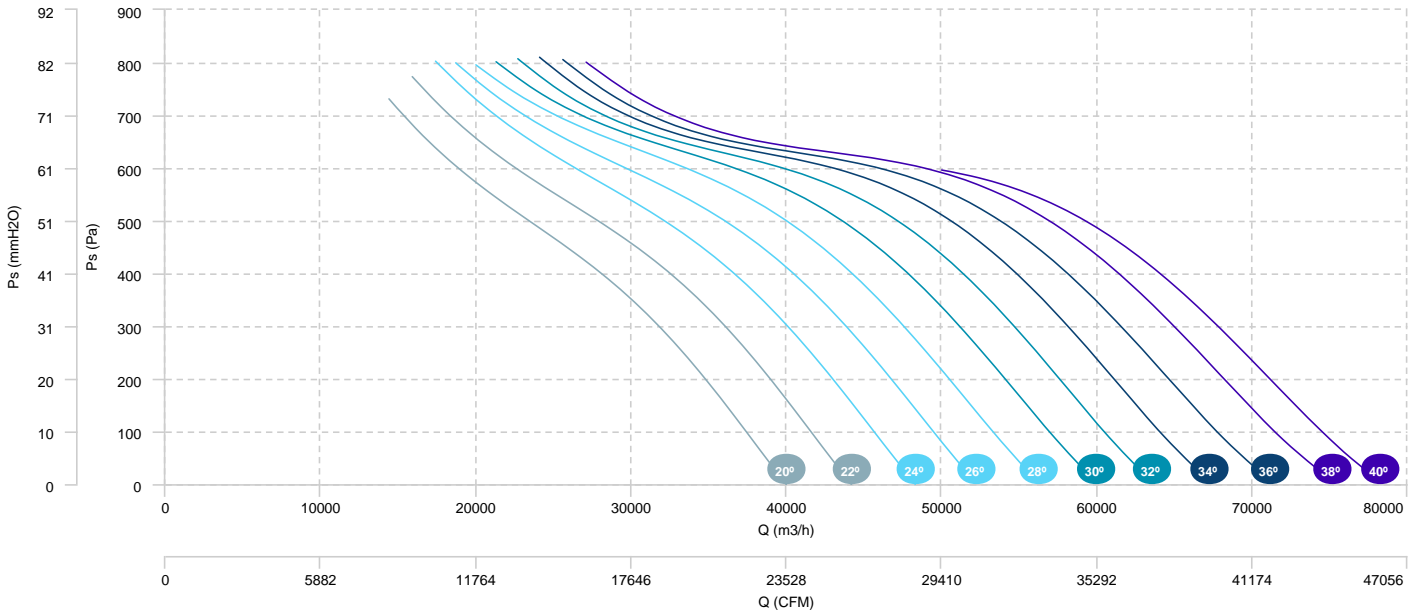

## AIR FLOW - ABSORBED POWER

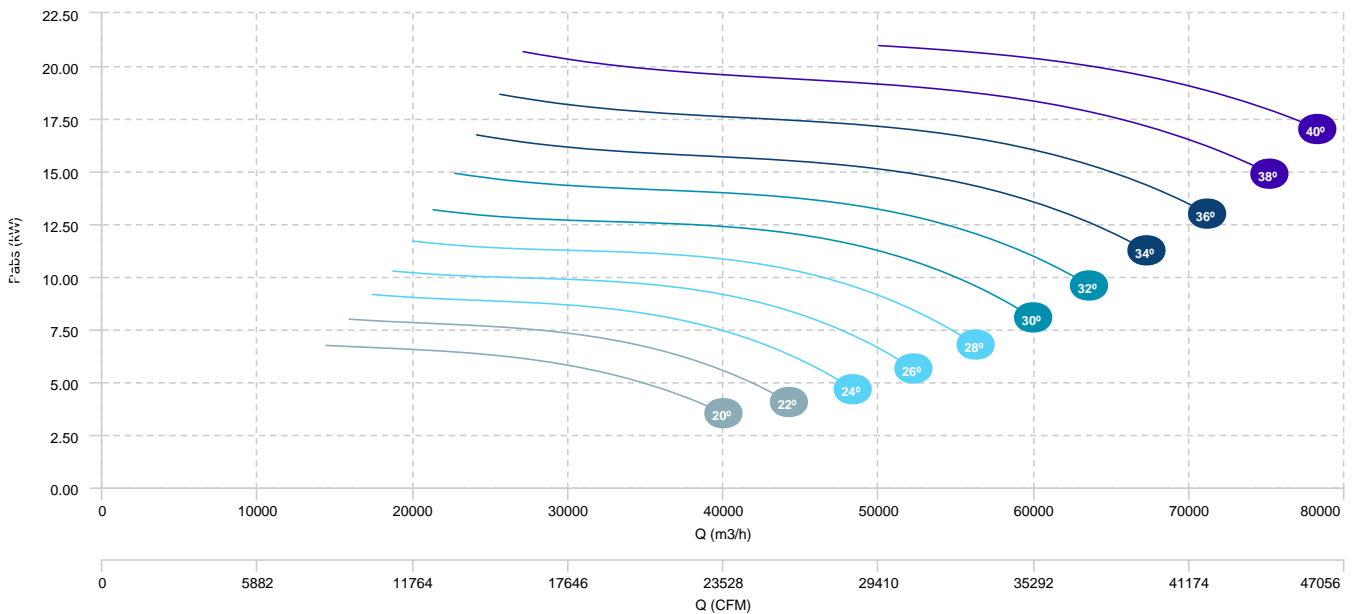

HBA 100 T6 2,2kW (A6:6)	HBA 100 T6 3kW (A6:6)	HBA 100 T6 4kW (A6:6)
HBA 100 T6 5,5kW (A6:6)	HBA 100 T6 7,5kW (A6:6)	

## AIR FLOW - PRESSURE

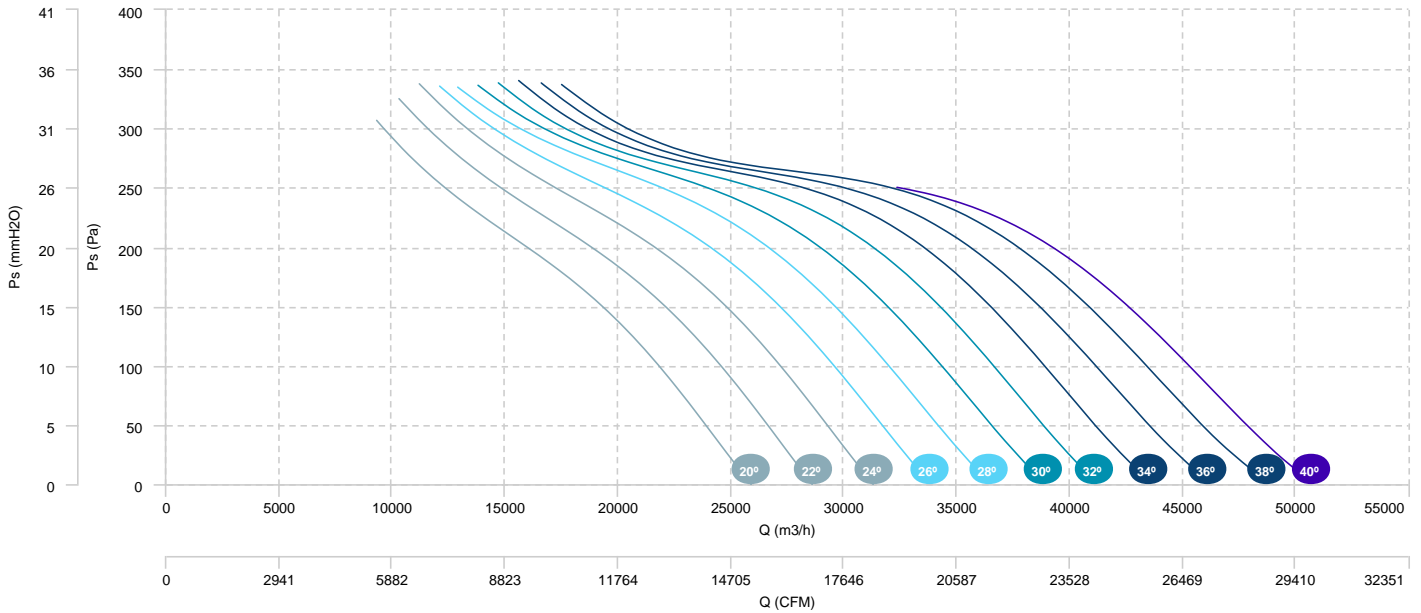

## AIR FLOW - ABSORBED POWER

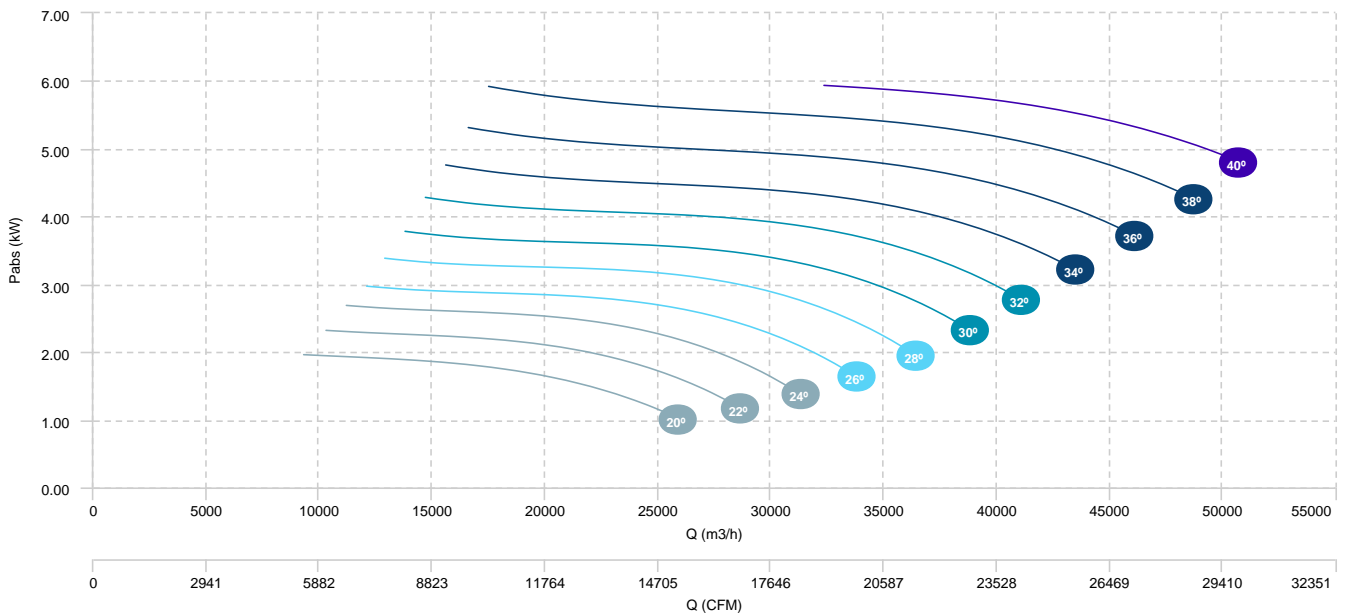



HBA 100 T6 1,5kW (A6:3)

HBA 100 T6 2,2kW (A6:3)

HBA 100 T6 3kW (A6:3)

HBA 100 T6 4kW (A6:3)

## AIR FLOW - PRESSURE

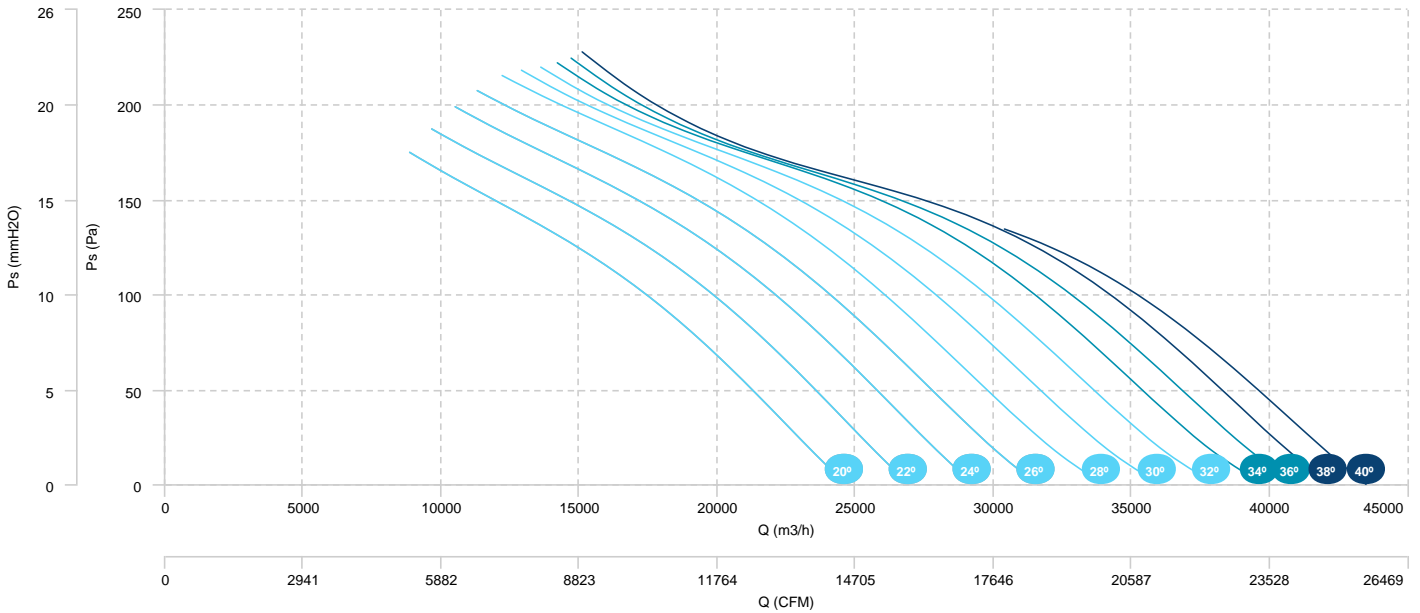

## AIR FLOW - ABSORBED POWER

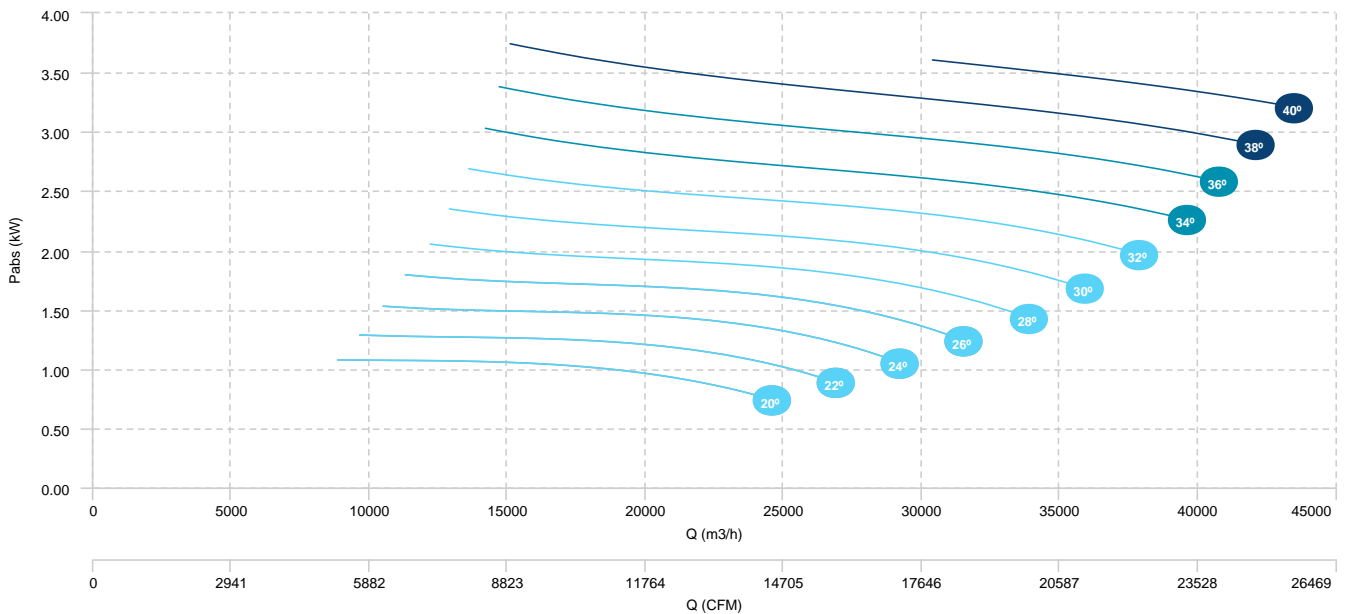

HBA 100 T4/T8 7,5/1,5kW (A6:6)	HBA 100 T4/T8 11/3kW (A6:6)	HBA 100 T4/T8 15/3,5kW (A6:6)
HBA 100 T4/T8 17/4,3kW (A6:6)	HBA 100 T4/T8 20/5kW (A6:6)	

AIR FLOW - PRESSURE (4 poles)

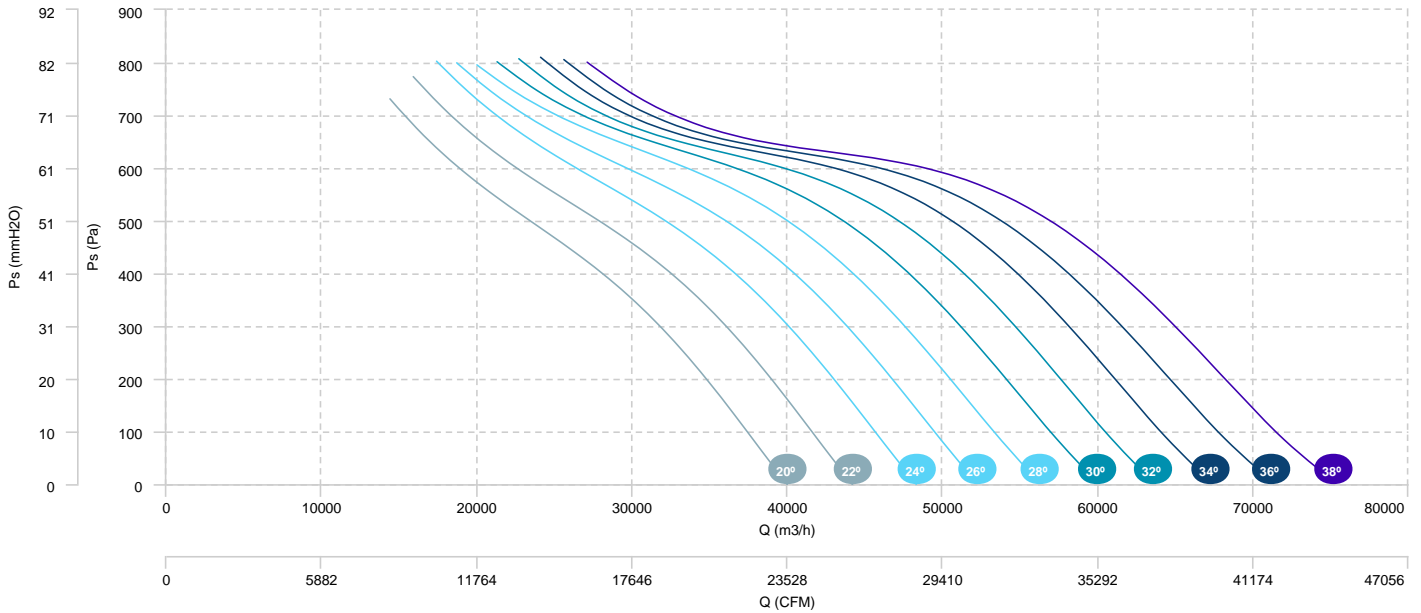

AIR FLOW - ABSORBED POWER (4 poles)

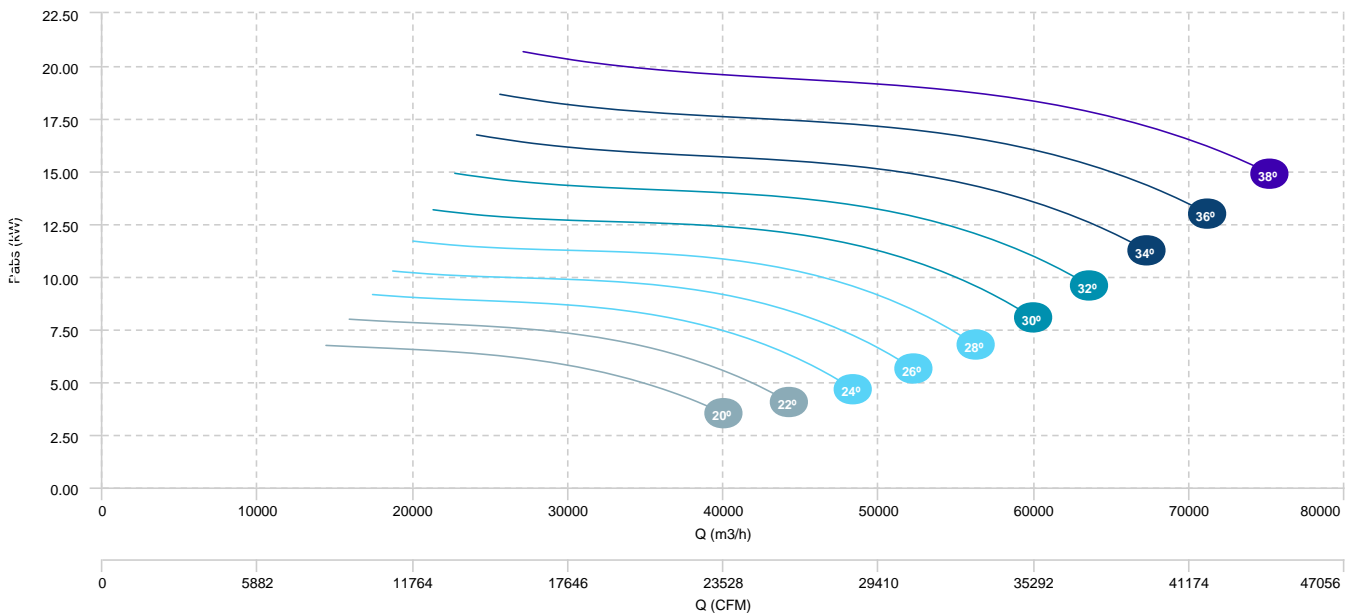

HBA 100 T4/T8 7,5/1,5kW (A6:6)	HBA 100 T4/T8 11/3kW (A6:6)	HBA 100 T4/T8 15/3,5kW (A6:6)
HBA 100 T4/T8 17/4,3kW (A6:6)	HBA 100 T4/T8 20/5kW (A6:6)	

## AIR FLOW - PRESSURE (8 poles)

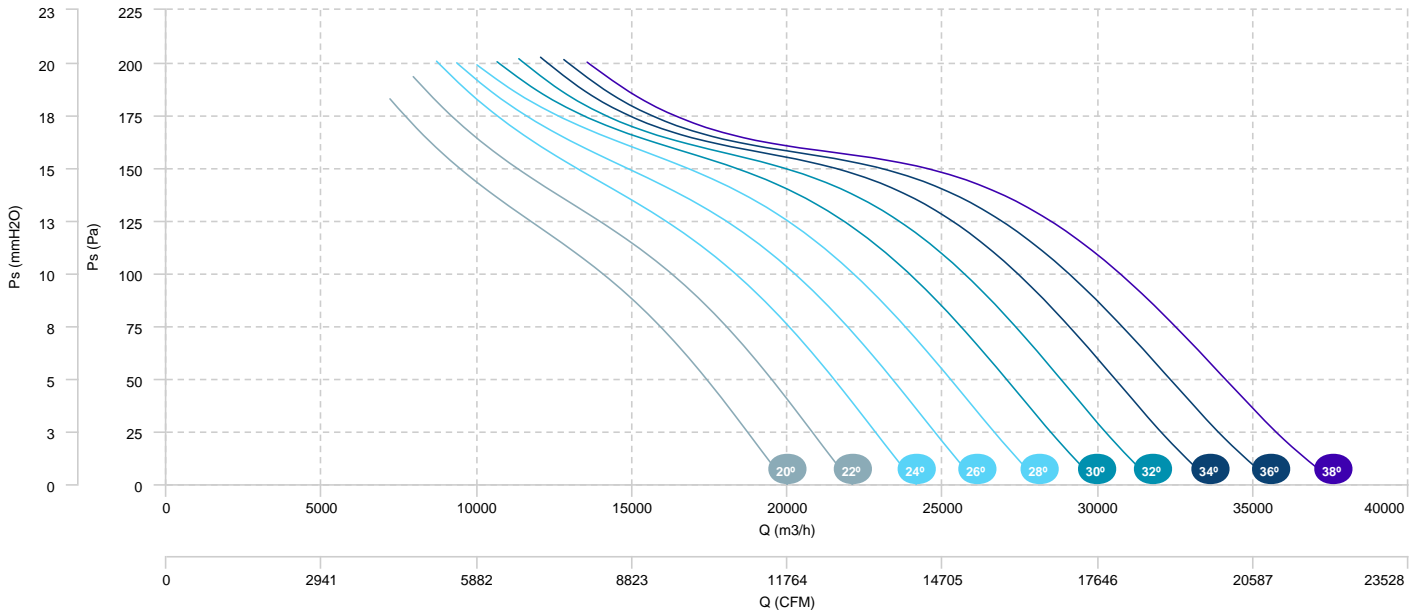

HBA 100 T4/T8 5,5/1,1kW (A6:3)	HBA 100 T4/T8 7,5/1,5kW (A6:3)	HBA 100 T4/T8 11/3kW (A6:3)
HBA 100 T4/T8 15/3,5kW (A6:3)		

AIR FLOW - PRESSURE (4 poles)

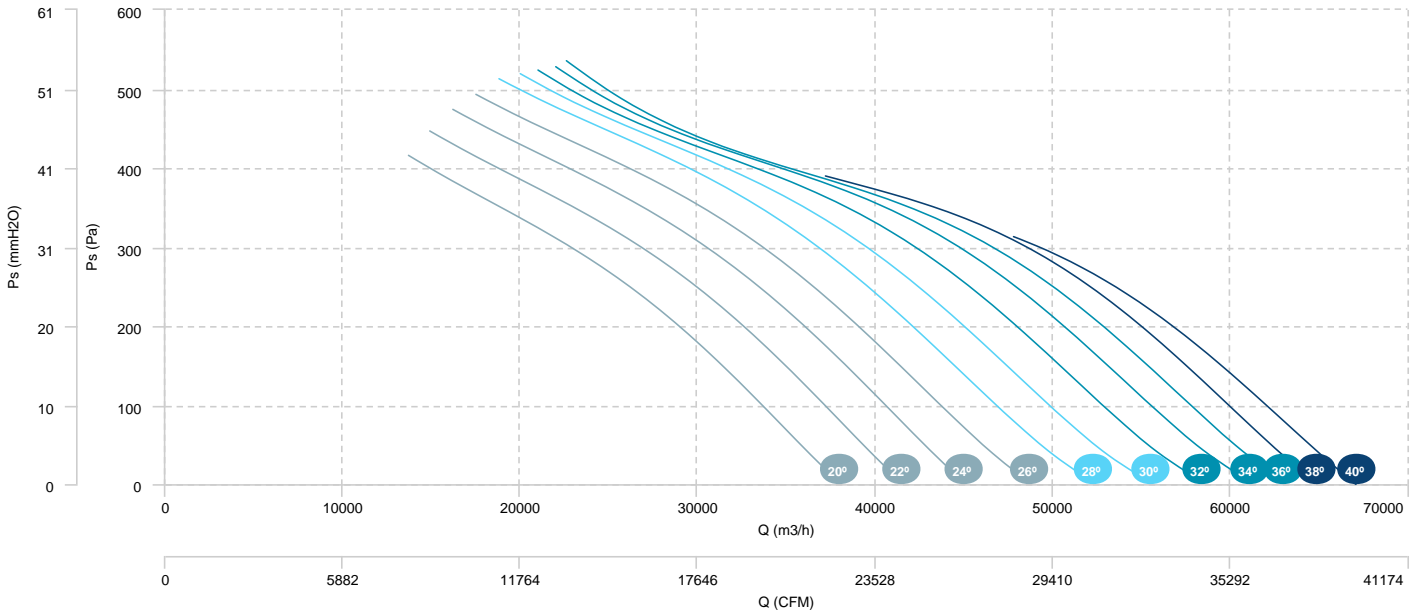

AIR FLOW - ABSORBED POWER (4 poles)

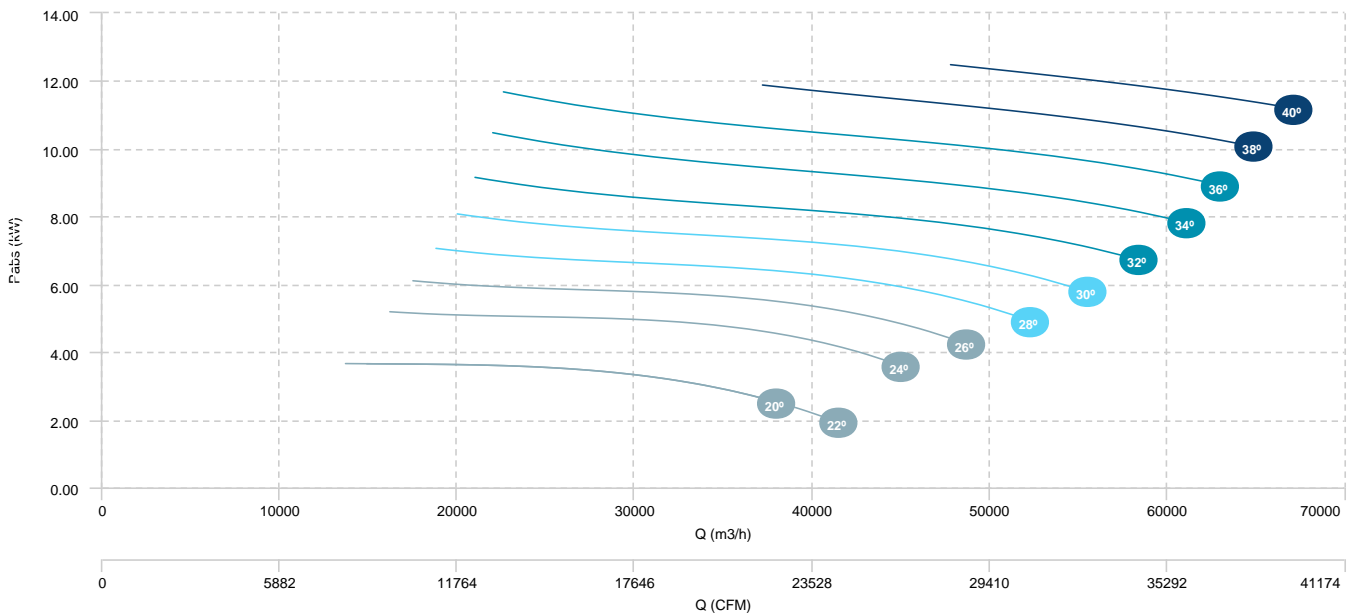

HBA 100 T4/T8 5,5/1,1kW (A6:3)

HBA 100 T4/T8 7,5/1,5kW (A6:3)

HBA 100 T4/T8 11/3kW (A6:3)

HBA 100 T4/T8 15/3,5kW (A6:3)

## AIR FLOW - PRESSURE (8 poles)

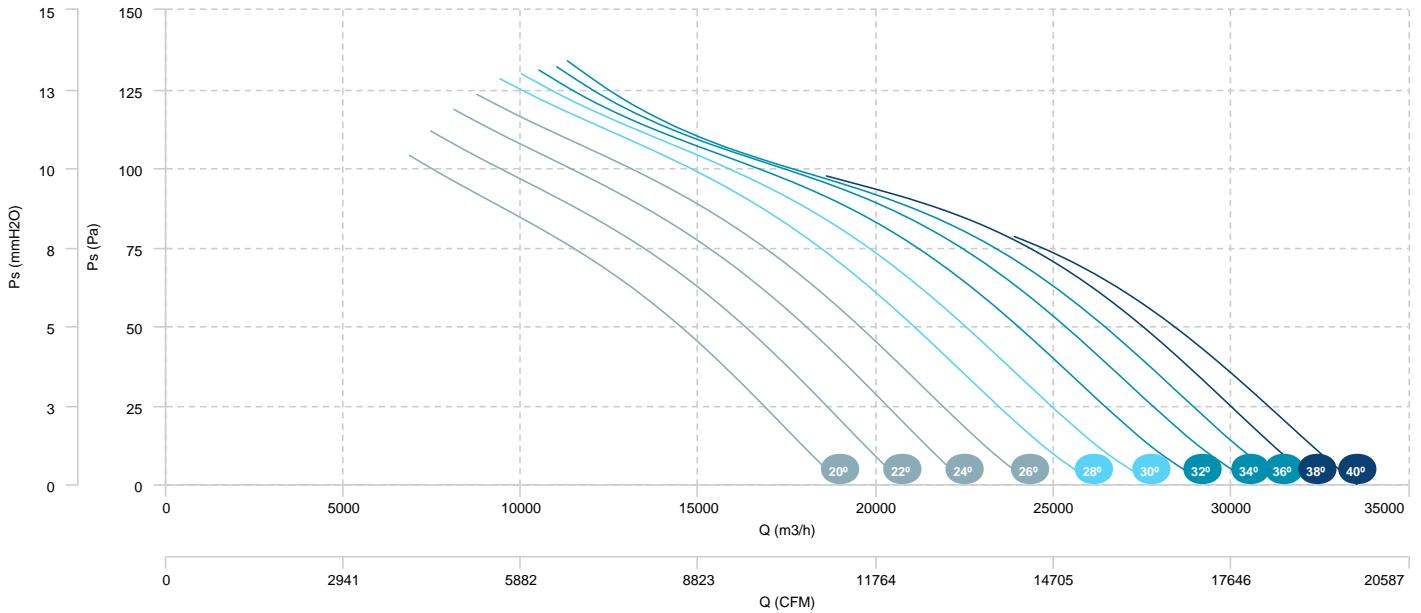

HBA 112 T4 5,5kW (A6:3)	HBA 112 T4 7,5kW (A6:3)	HBA 112 T4 11kW (A6:3)
HBA 112 T4 15kW (A6:3)	HBA 112 T4 18,5kW (A6:3)	HBA 112 T4 22kW (A6:3)

## AIR FLOW - PRESSURE

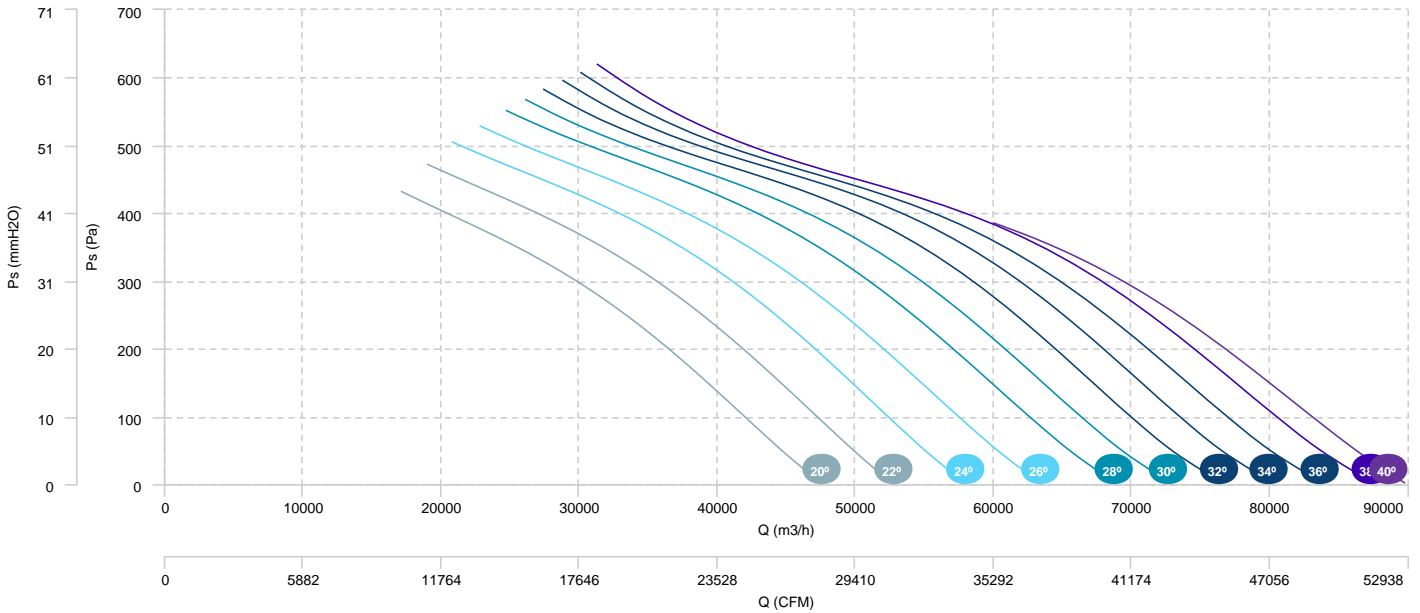

## AIR FLOW - ABSORBED POWER

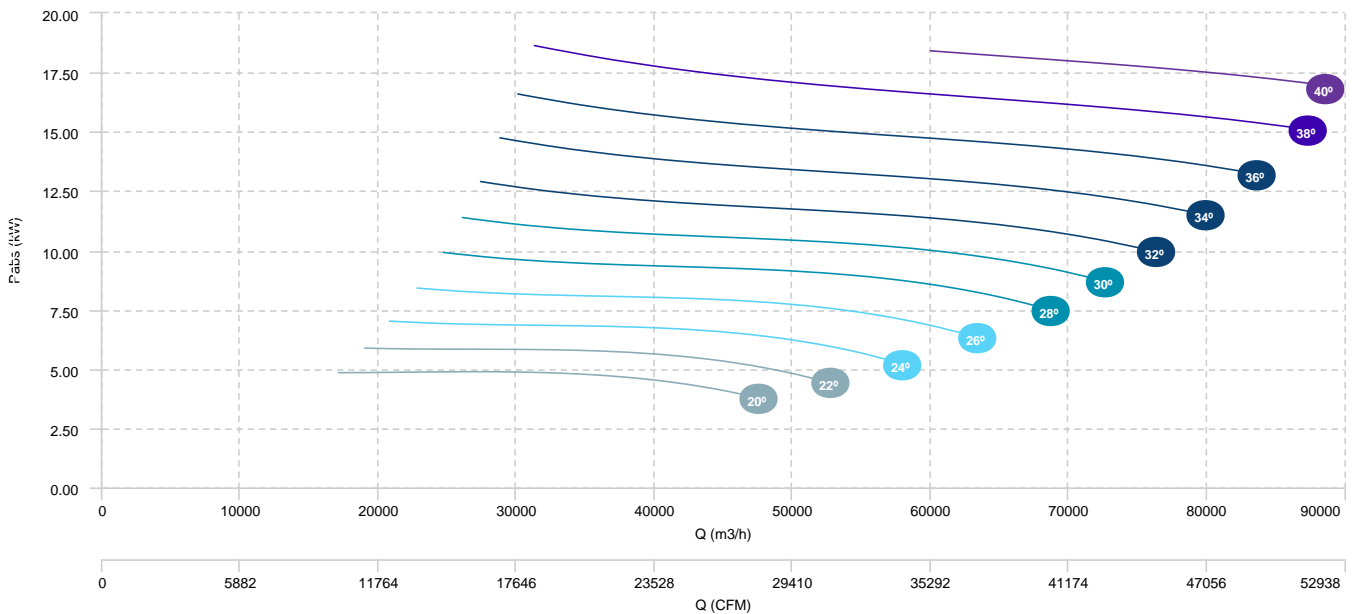

HBA 112 T4 11kW (A6:6)	HBA 112 T4 15kW (A6:6)	HBA 112 T4 18,5kW (A6:6)
HBA 112 T4 22kW (A6:6)	HBA 112 T4 30kW (A6:6)	

## AIR FLOW - PRESSURE

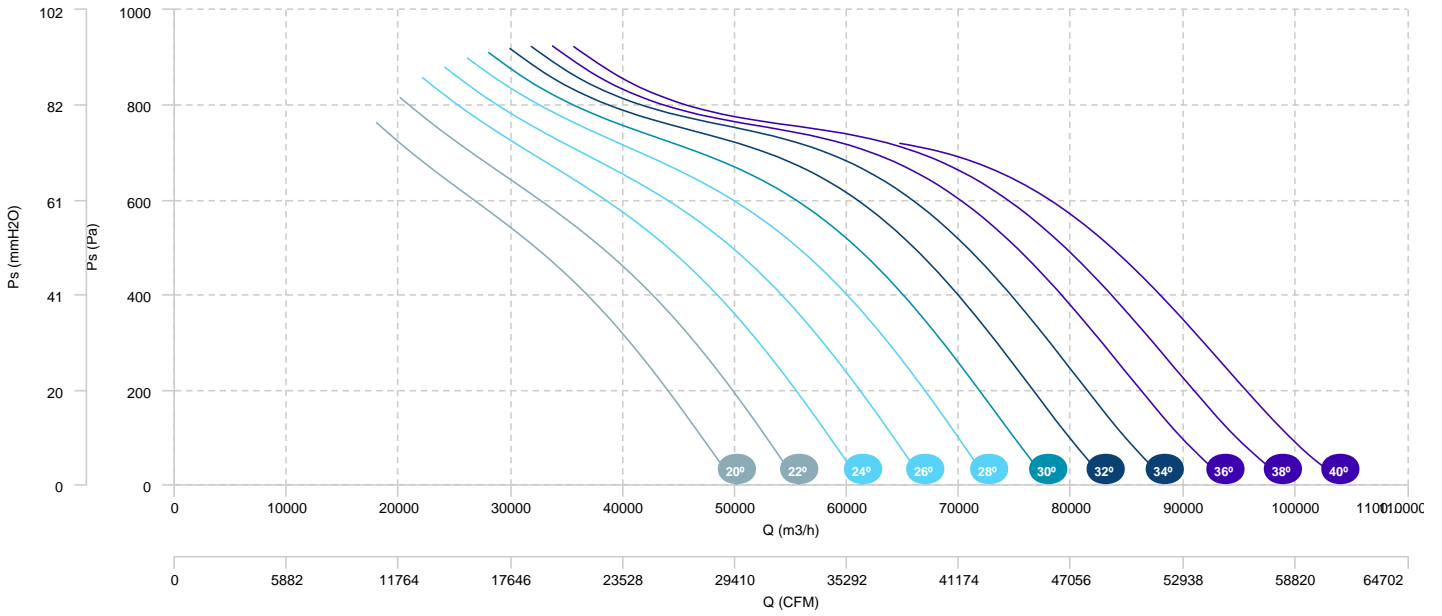

## AIR FLOW - ABSORBED POWER

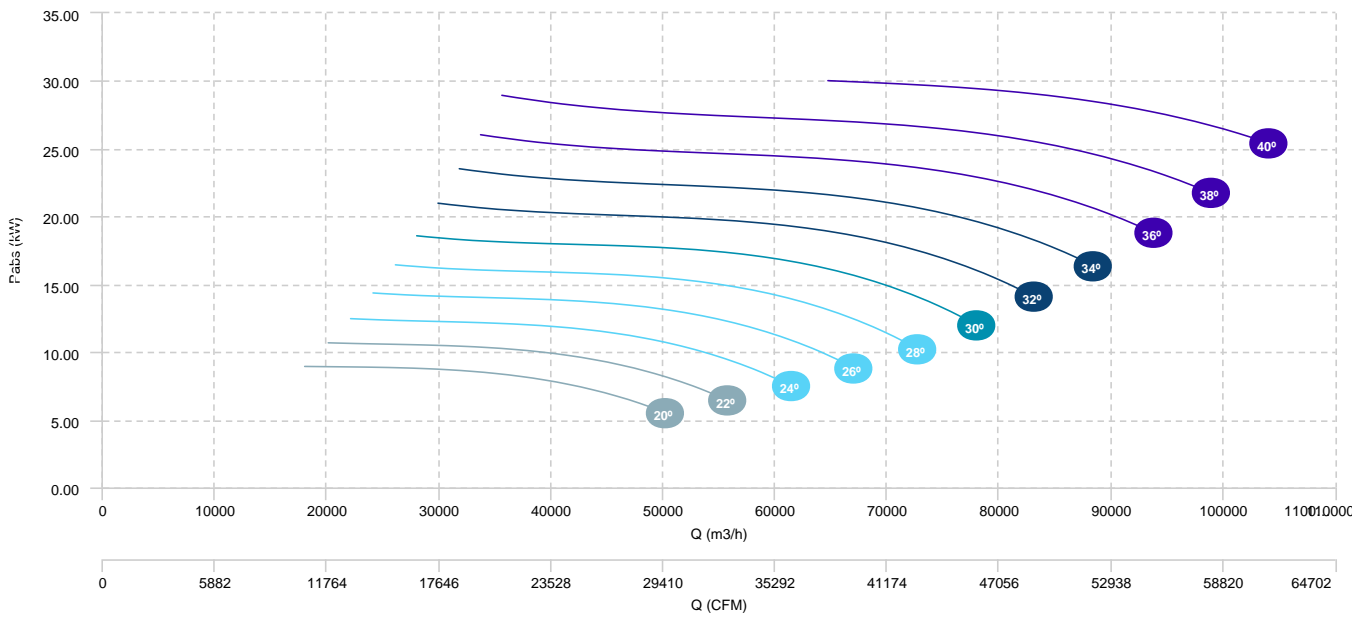

HBA 112 T6 2,2kW (A6:6)	HBA 112 T6 3kW (A6:6)	HBA 112 T6 4kW (A6:6)
HBA 112 T6 5,5kW (A6:6)	HBA 112 T6 7,5kW (A6:6)	HBA 112 T6 11kW (A6:6)

## AIR FLOW - PRESSURE

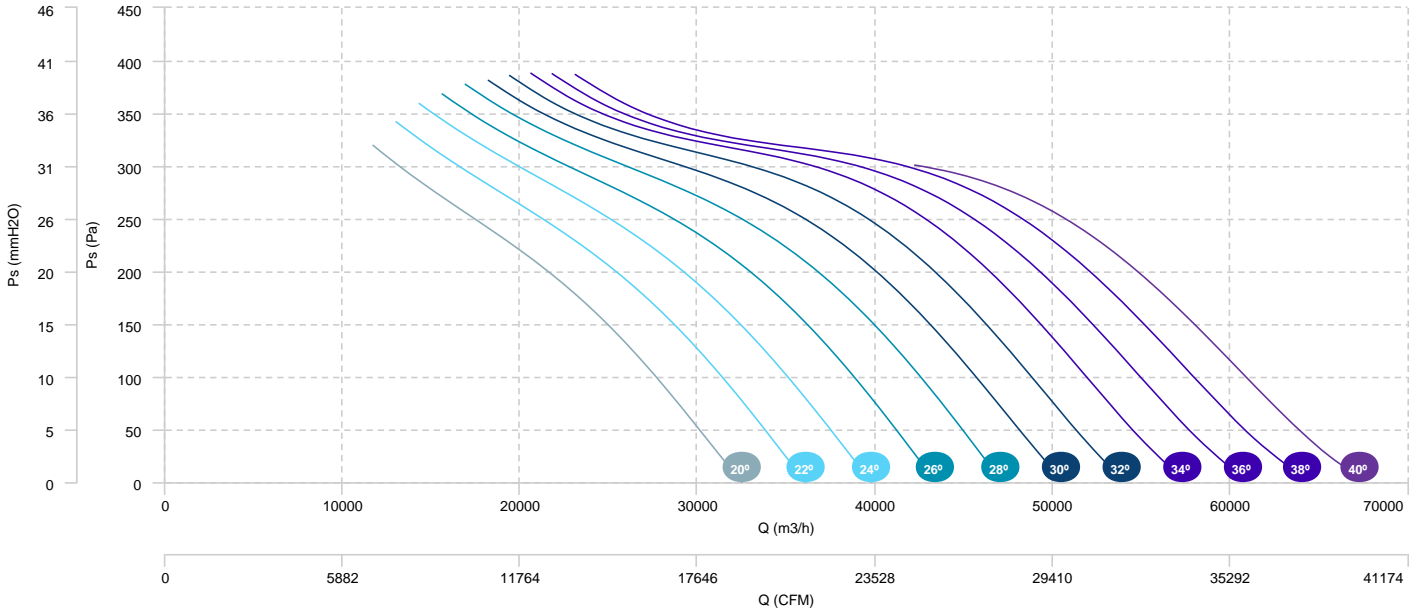

## AIR FLOW - ABSORBED POWER

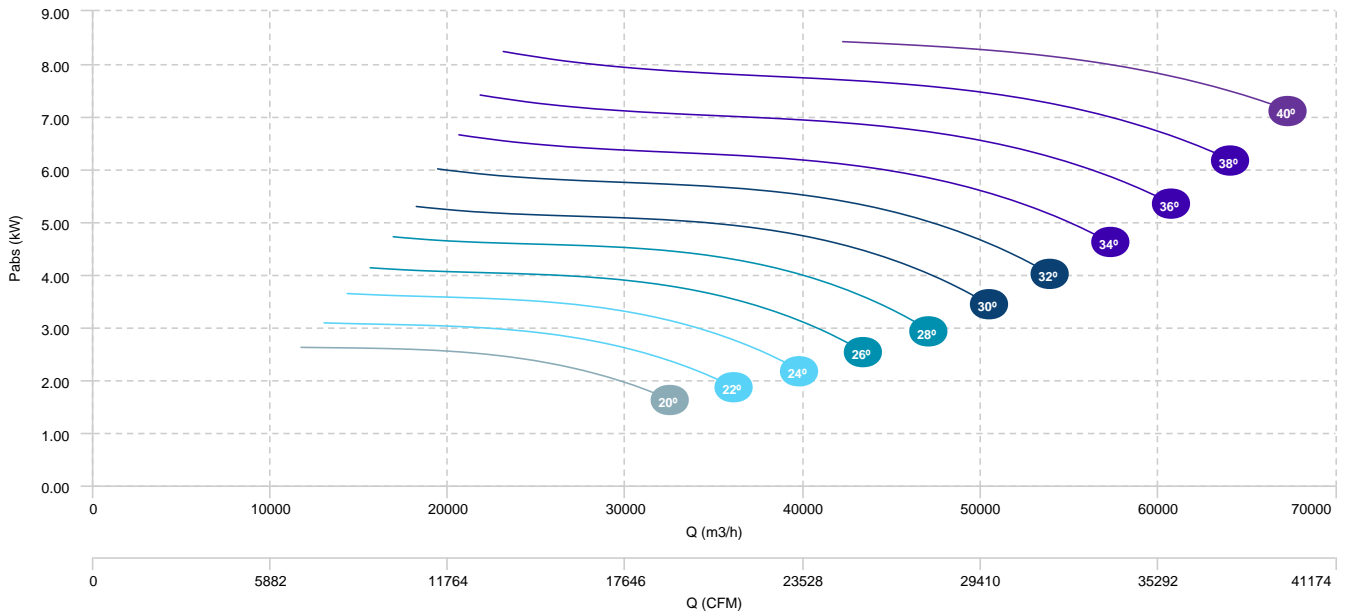



HBA 112 T6 2,2kW (A6:3)  
HBA 112 T6 5,5kW (A6:3)

HBA 112 T6 3kW (A6:3)

HBA 112 T6 4kW (A6:3)

## AIR FLOW - PRESSURE

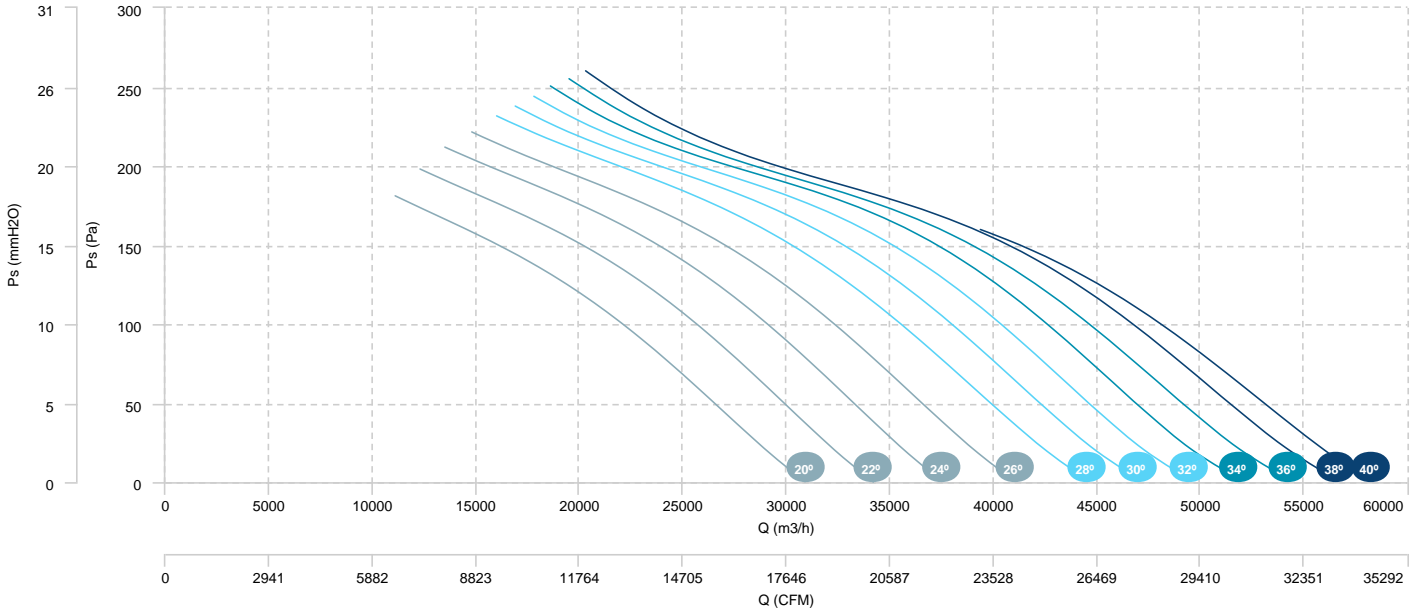

## AIR FLOW - ABSORBED POWER

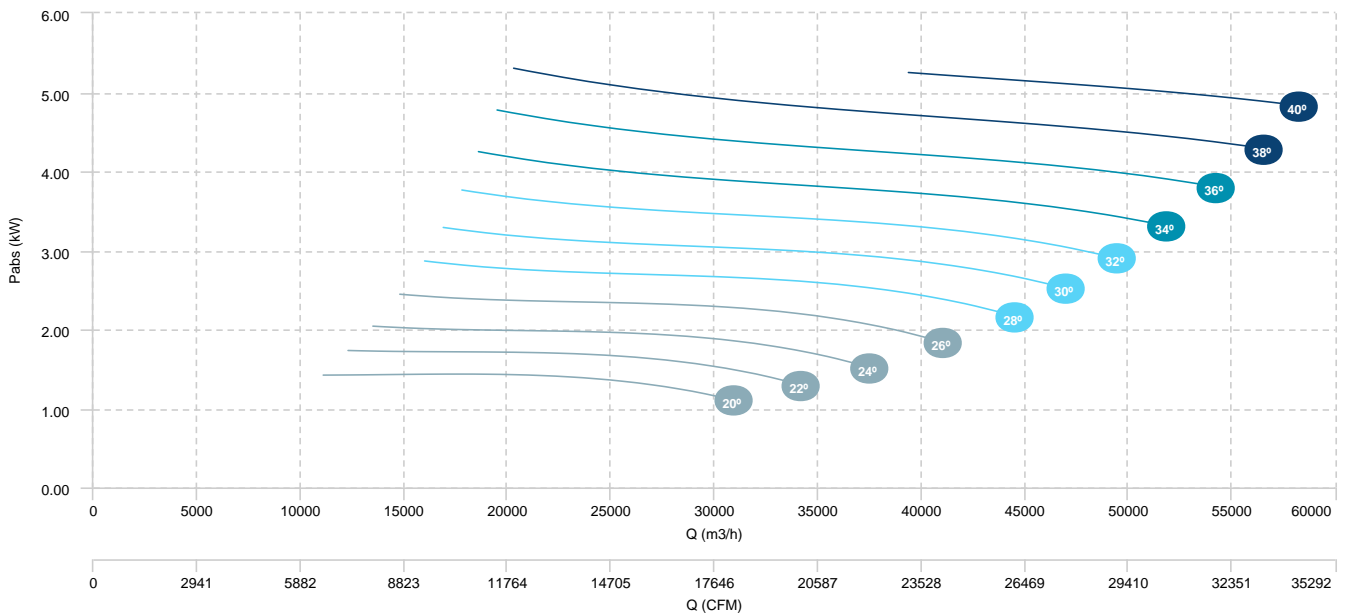

HBA 112 T4/T8 11/3kW (A6:6)	HBA 112 T4/T8 15/3,5kW (A6:6)	HBA 112 T4/T8 17/4,3kW (A6:6)
HBA 112 T4/T8 20/5kW (A6:6)	HBA 112 T4/T8 28/6,5kW (A6:6)	HBA 112 T4/T8 35/8kW (A6:6)

## AIR FLOW - PRESSURE (4 poles)

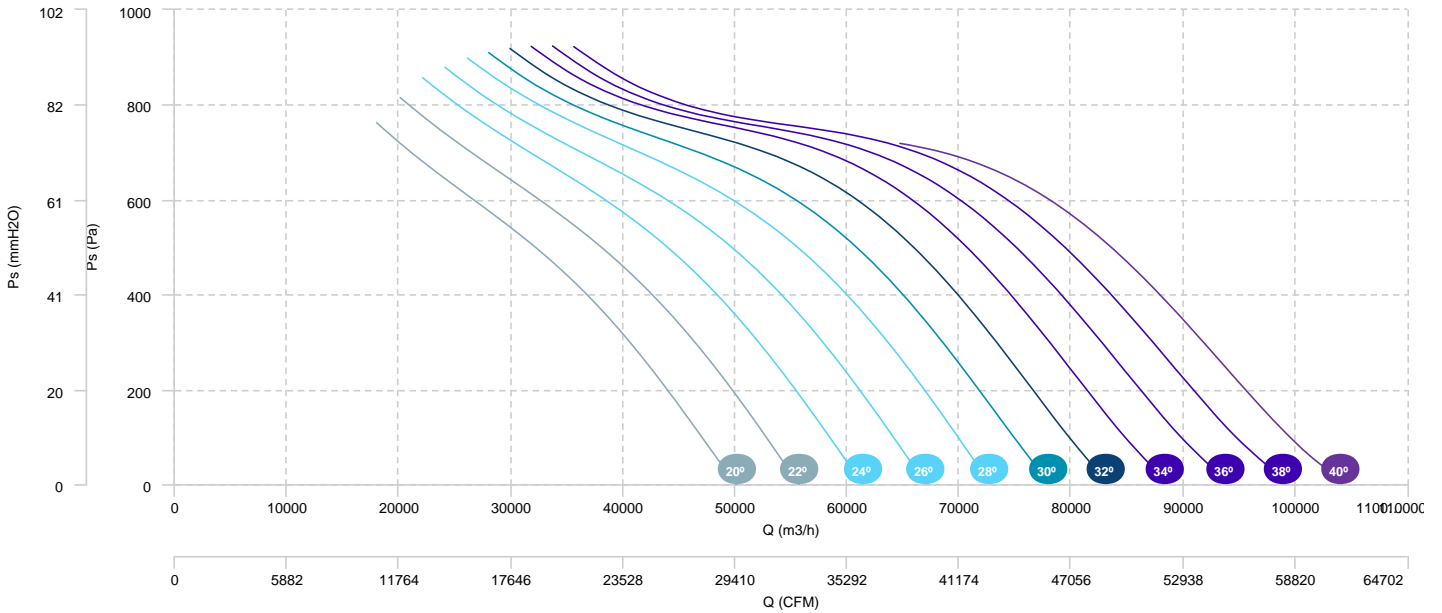

## AIR FLOW - ABSORBED POWER (4 poles)

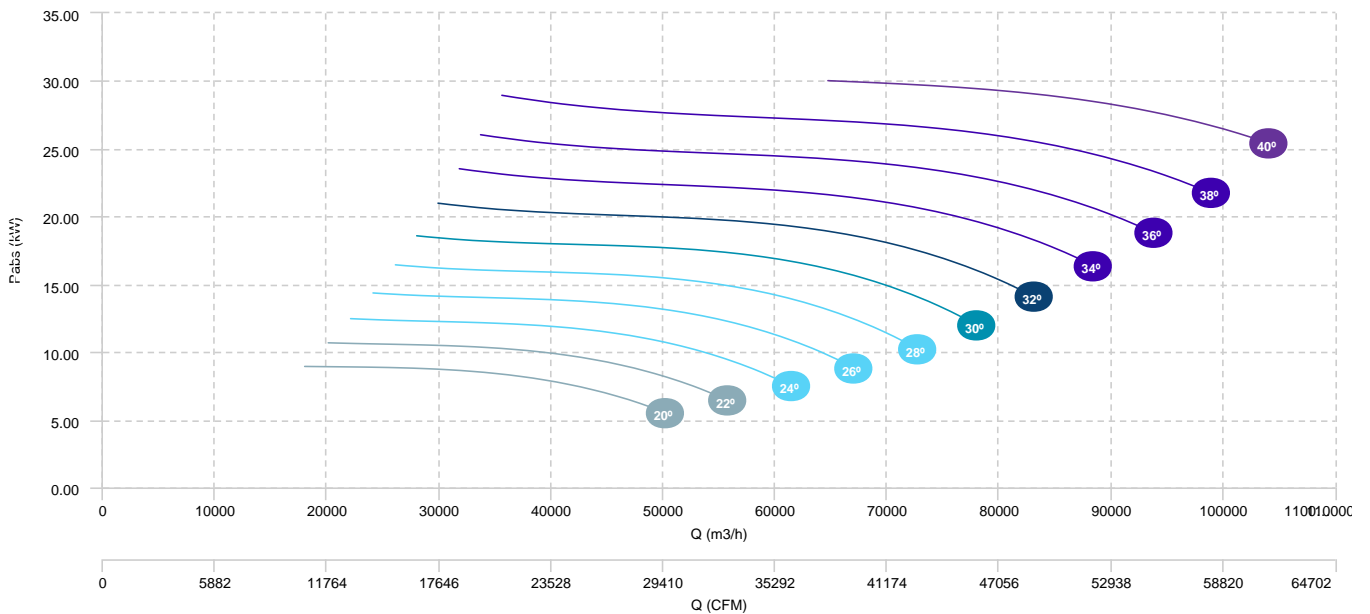

HBA 112 T4/T8 11/3kW (A6:6)	HBA 112 T4/T8 15/3,5kW (A6:6)	HBA 112 T4/T8 17/4,3kW (A6:6)
HBA 112 T4/T8 20/5kW (A6:6)	HBA 112 T4/T8 28/6,5kW (A6:6)	HBA 112 T4/T8 35/8kW (A6:6)

## AIR FLOW - PRESSURE (8 poles)

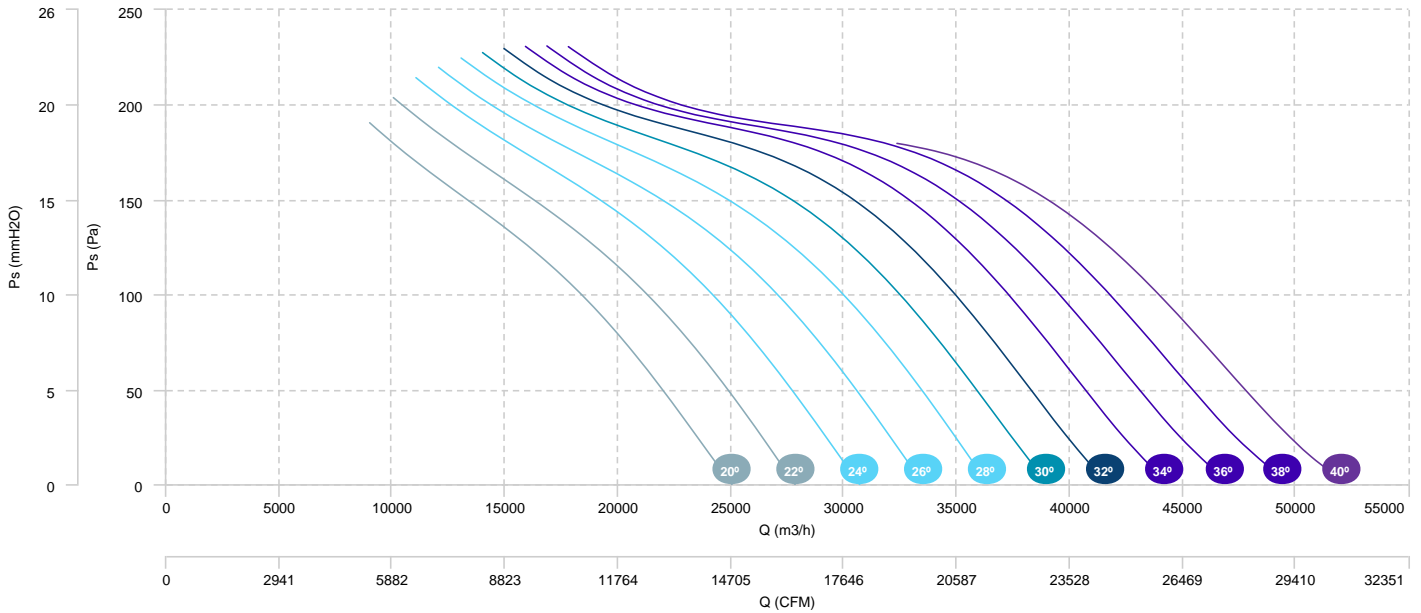

HBA 112 T4/T8 5,5/1,1kW (A6:3)	HBA 112 T4/T8 7,5/1,5kW (A6:3)	HBA 112 T4/T8 11/3kW (A6:3)
HBA 112 T4/T8 15/3,5kW (A6:3)	HBA 112 T4/T8 17/4,3kW (A6:3)	HBA 112 T4/T8 20/5kW (A6:3)

## AIR FLOW - PRESSURE (4 poles)

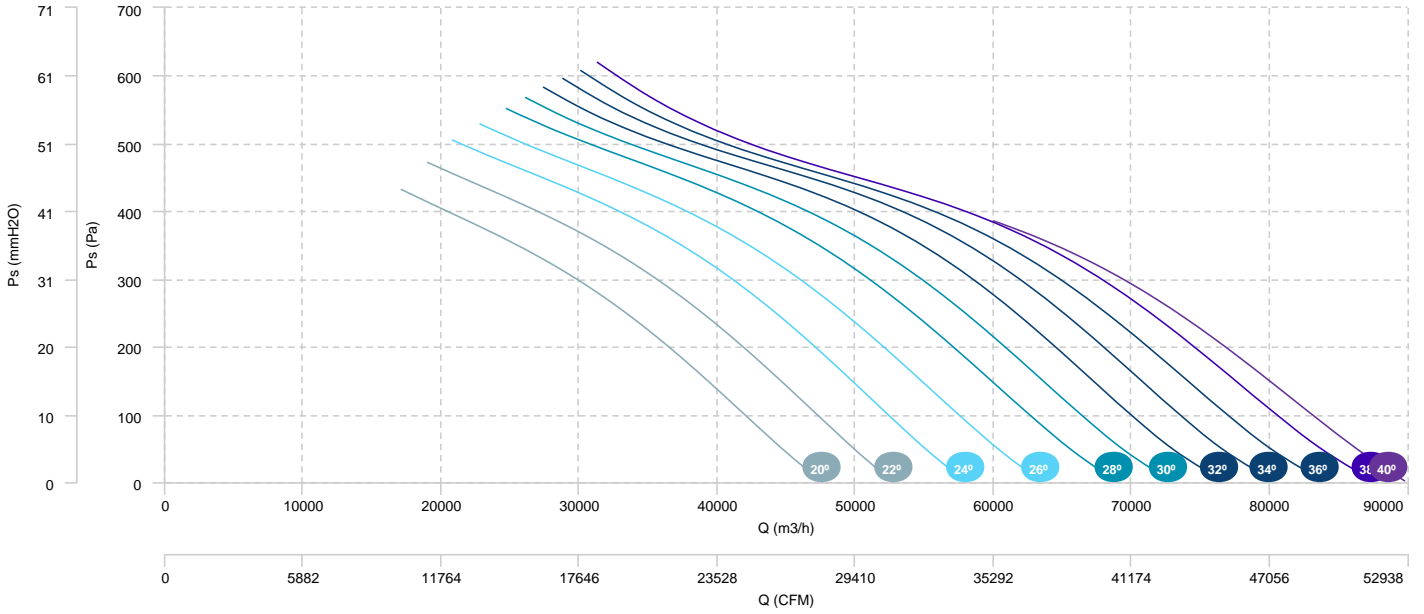

## AIR FLOW - ABSORBED POWER (4 poles)

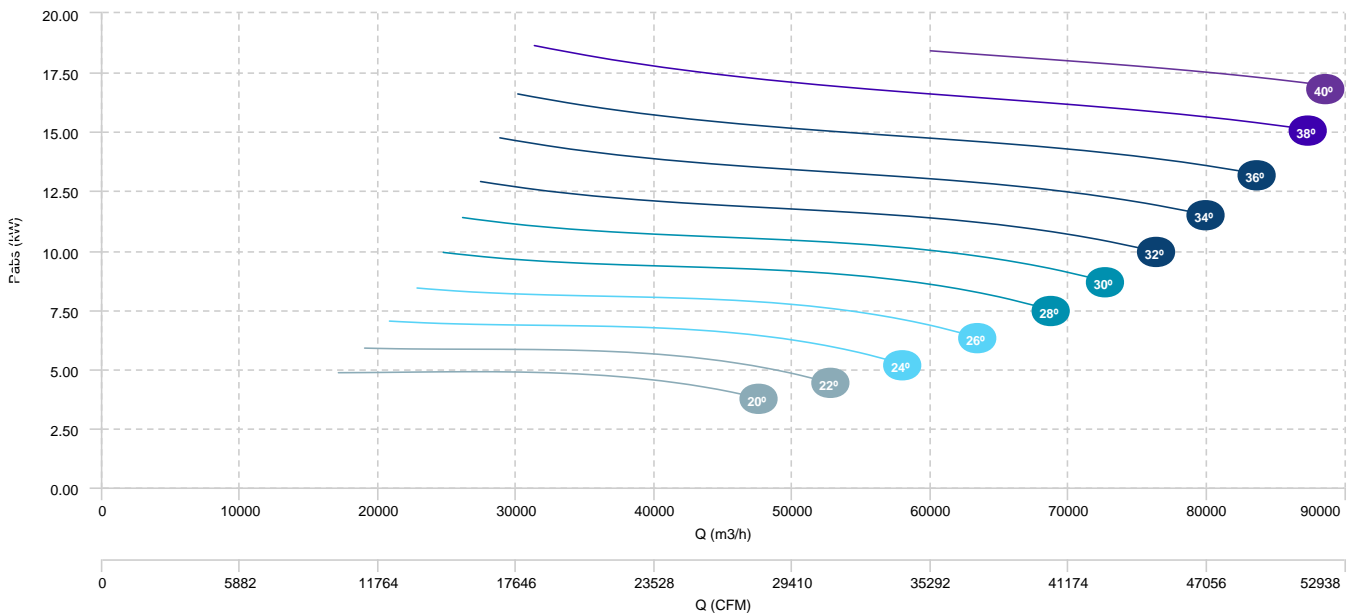

HBA 112 T4/T8 5,5/1,1kW (A6:3)	HBA 112 T4/T8 7,5/1,5kW (A6:3)	HBA 112 T4/T8 11/3kW (A6:3)
HBA 112 T4/T8 15/3,5kW (A6:3)	HBA 112 T4/T8 17/4,3kW (A6:3)	HBA 112 T4/T8 20/5kW (A6:3)

## AIR FLOW - PRESSURE (8 poles)

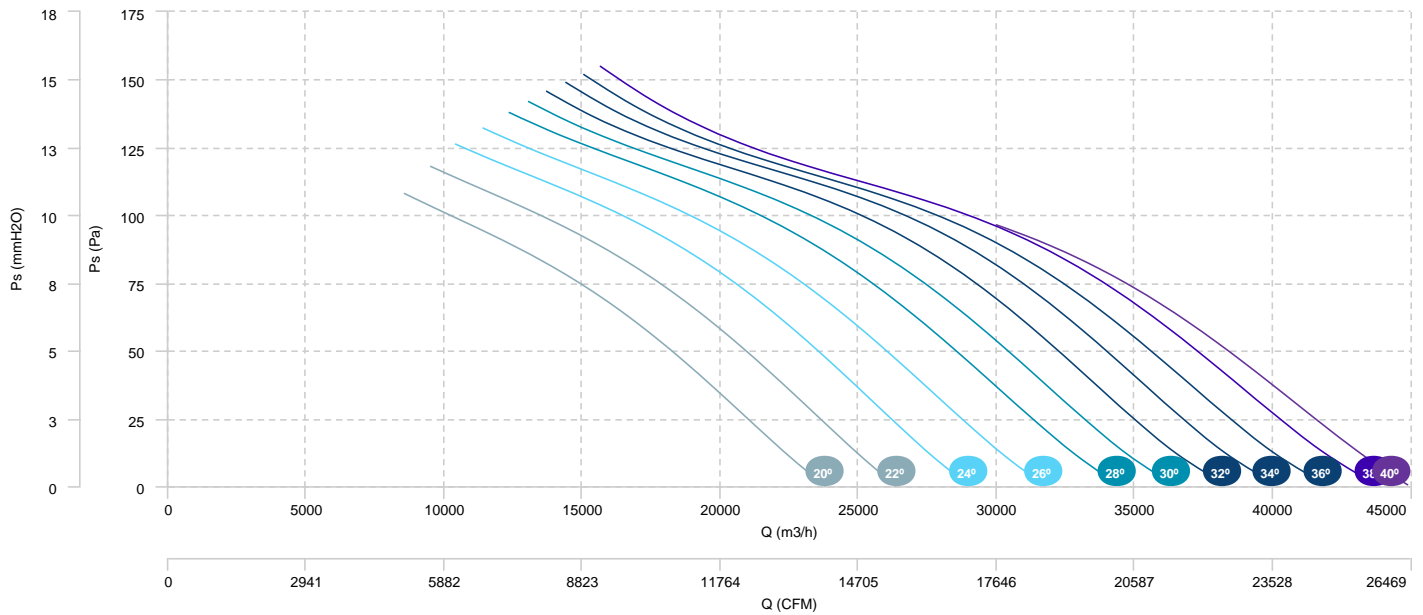

HBA 125 T4 15kW (A7:8)	HBA 125 T4 18,5kW (A7:8)	HBA 125 T4 22kW (A7:8)
HBA 125 T4 30kW (A7:8)	HBA 125 T4 37kW (A7:8)	HBA 125 T4 45kW (A7:8)

## AIR FLOW - PRESSURE

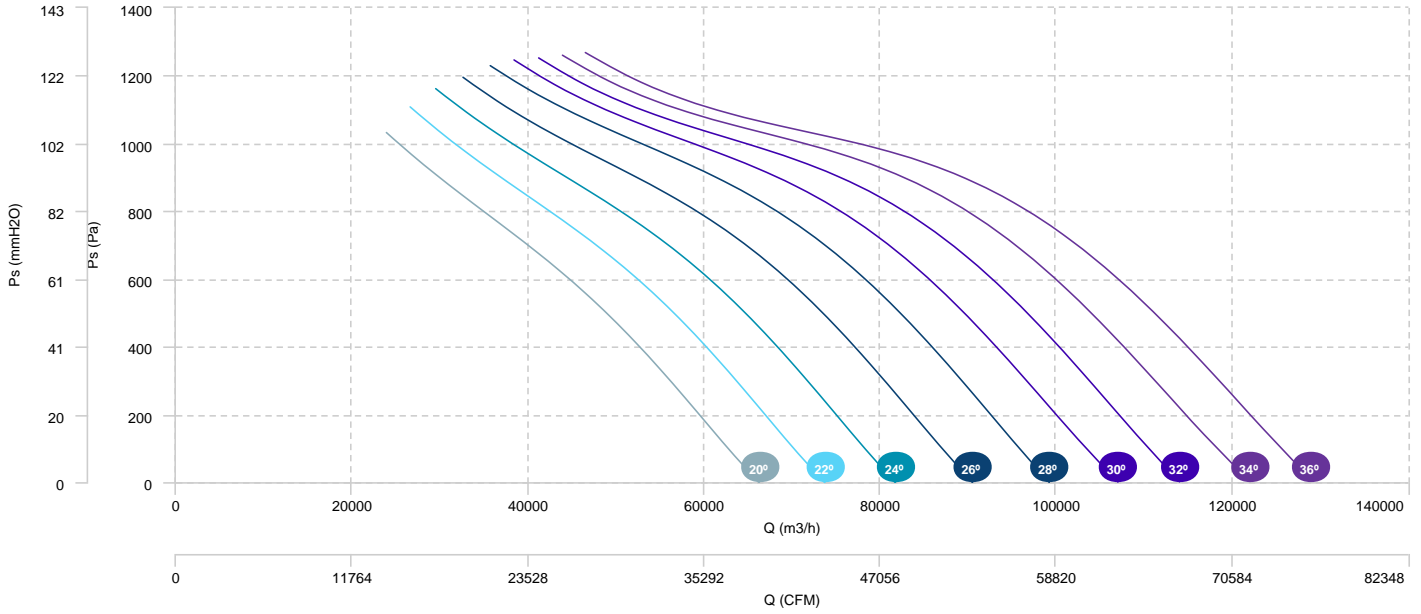

## AIR FLOW - ABSORBED POWER

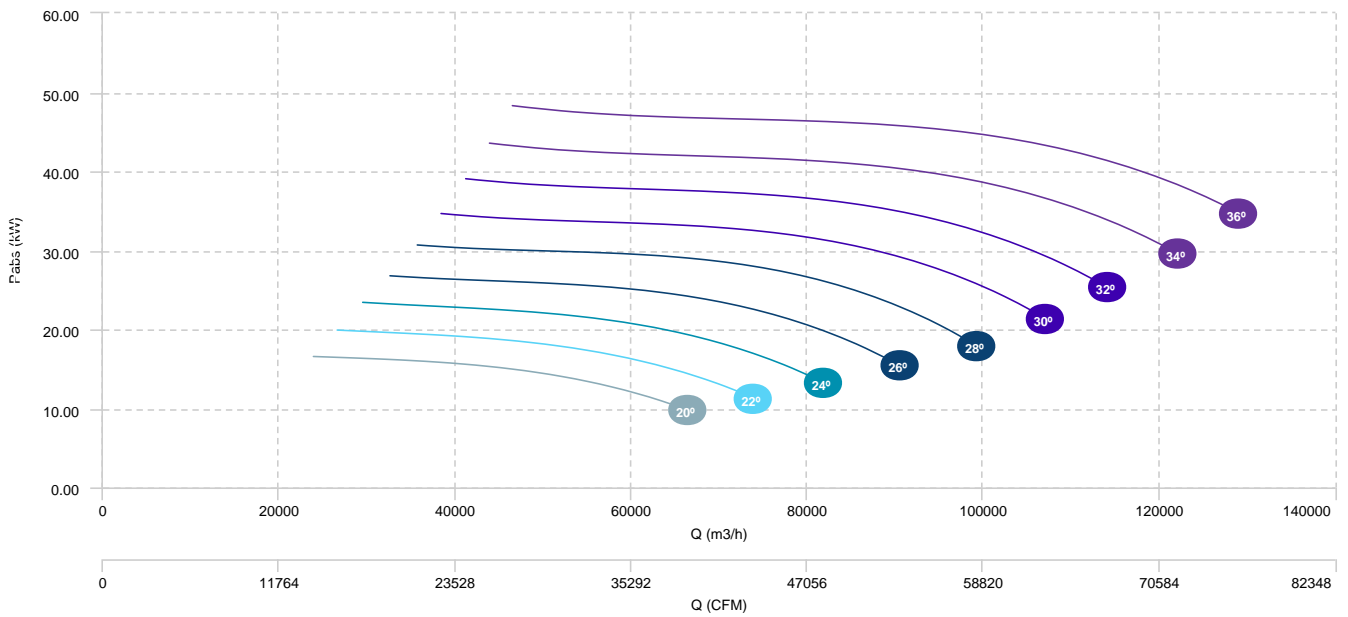

HBA 125 T4 11kW (A7:4)	HBA 125 T4 15kW (A7:4)	HBA 125 T4 18,5kW (A7:4)
HBA 125 T4 22kW (A7:4)	HBA 125 T4 30kW (A7:4)	HBA 125 T4 37kW (A7:4)

## AIR FLOW - PRESSURE

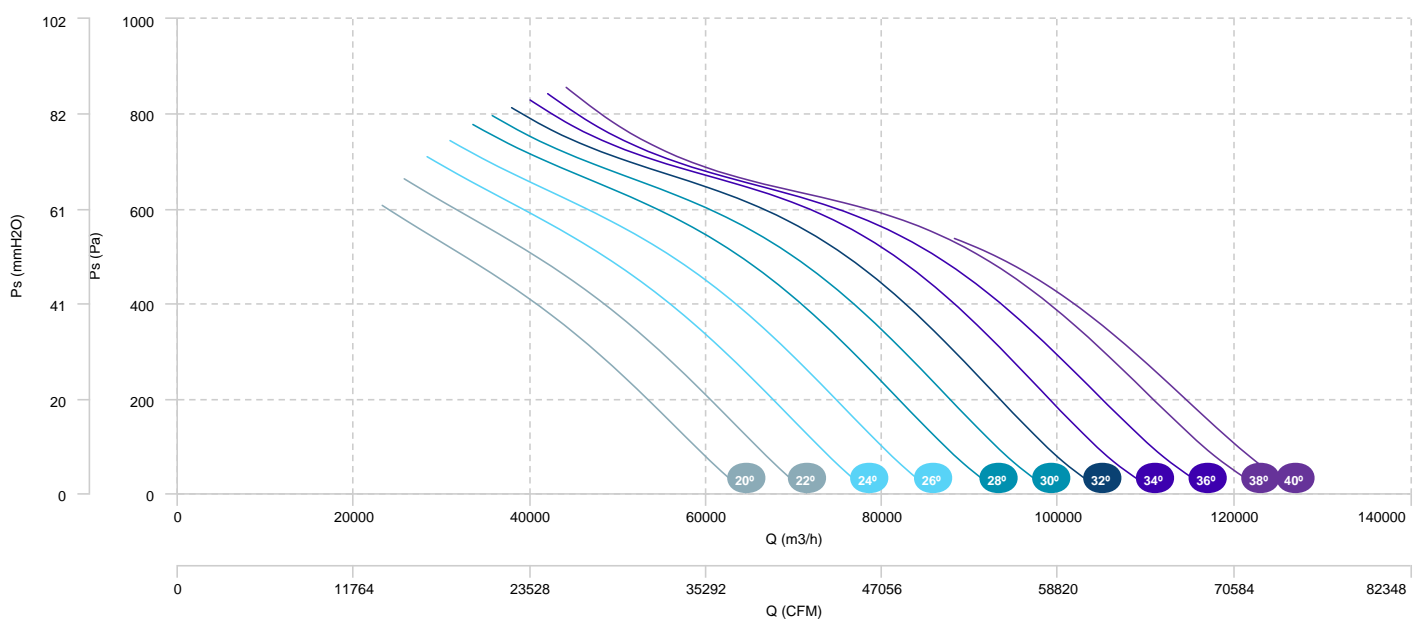

## AIR FLOW - ABSORBED POWER

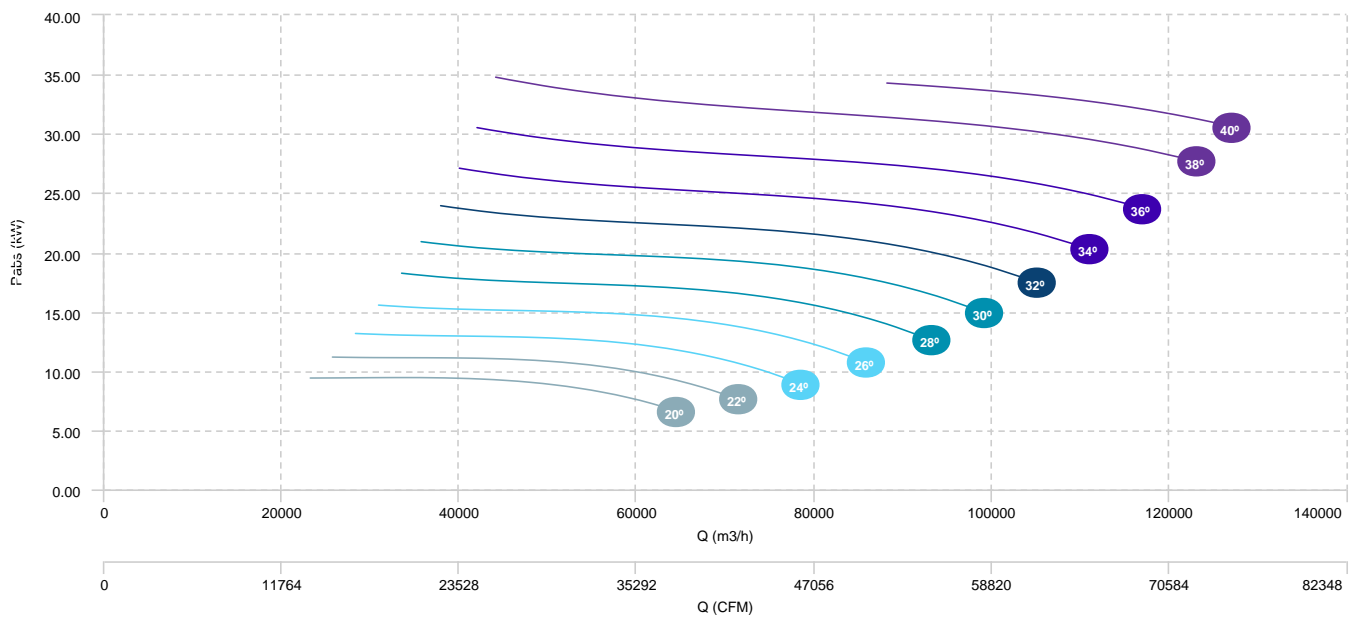

HBA 125 T6 5,5kW (A7:8)	HBA 125 T6 7,5kW (A7:8)	HBA 125 T6 11kW (A7:8)
HBA 125 T6 15kW (A7:8)		

## AIR FLOW - PRESSURE

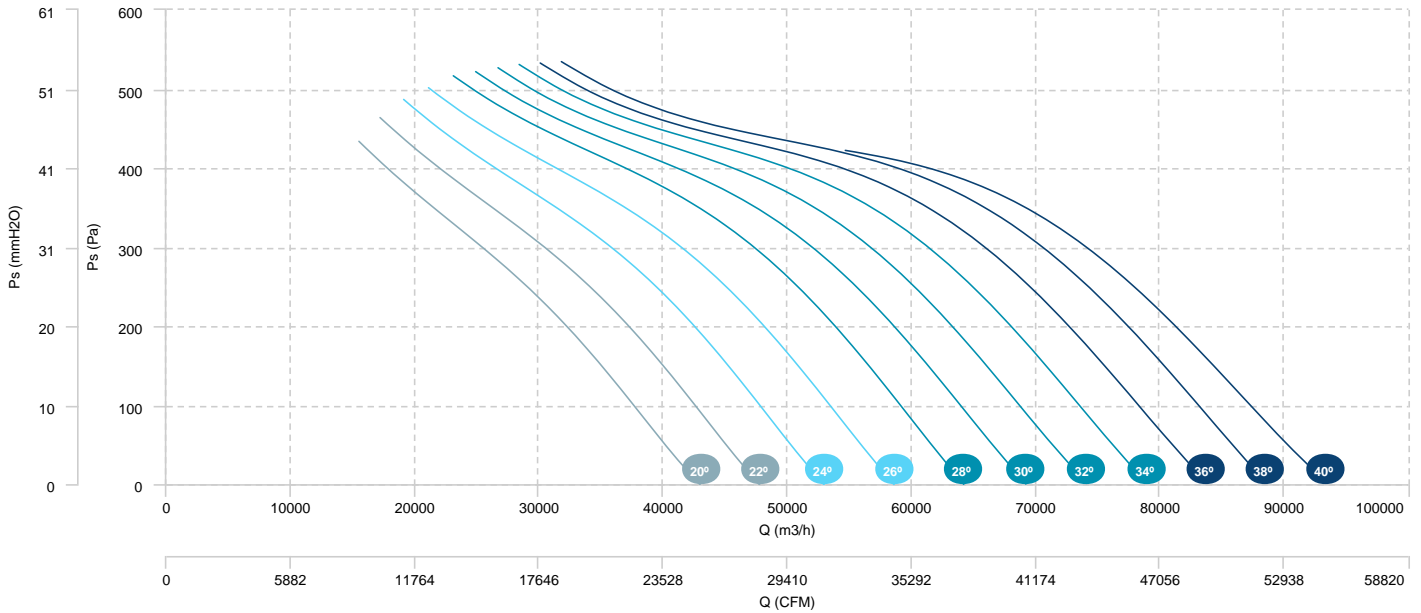

## AIR FLOW - ABSORBED POWER

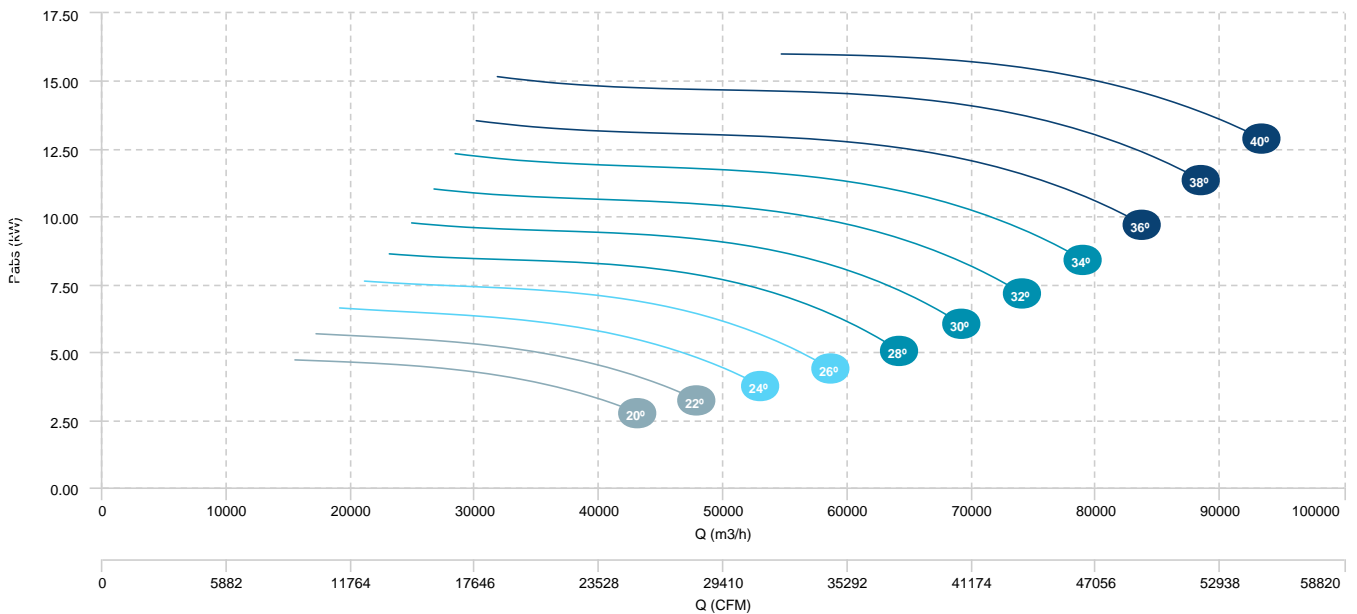



HBA 125 T6 3kW (A7:4)	HBA 125 T6 4kW (A7:4)	HBA 125 T6 5,5kW (A7:4)
HBA 125 T6 7,5kW (A7:4)	HBA 125 T6 11kW (A7:4)	

## AIR FLOW - PRESSURE

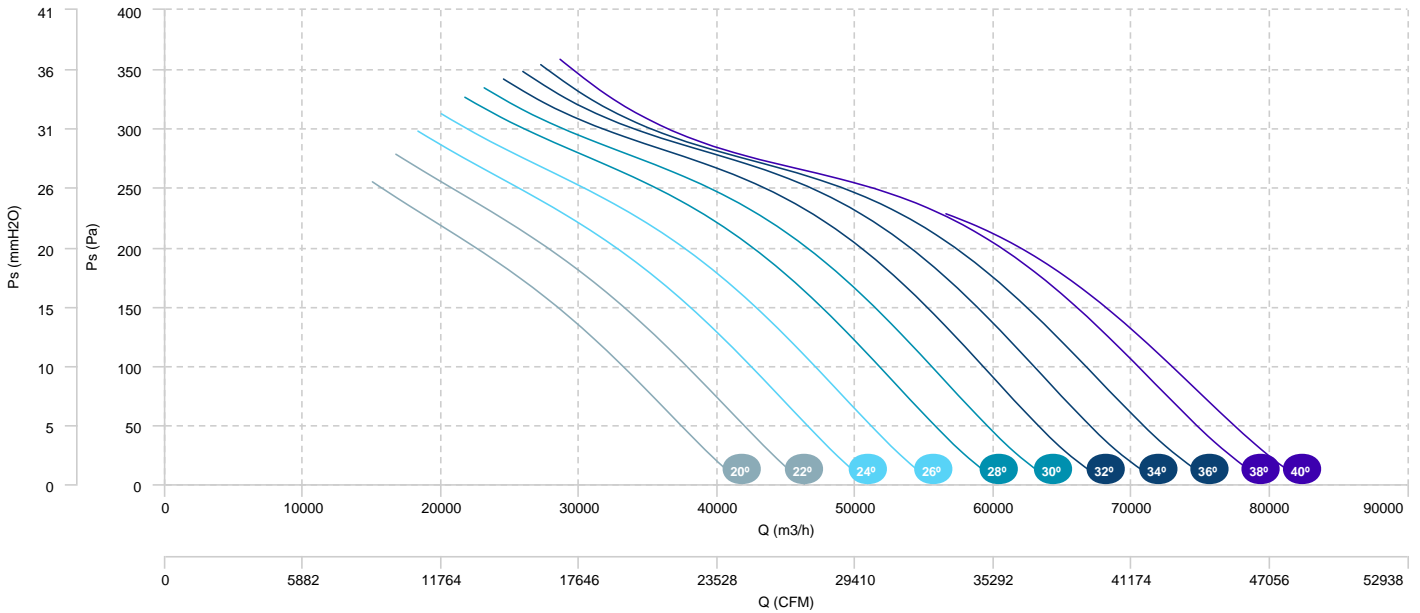

## AIR FLOW - ABSORBED POWER

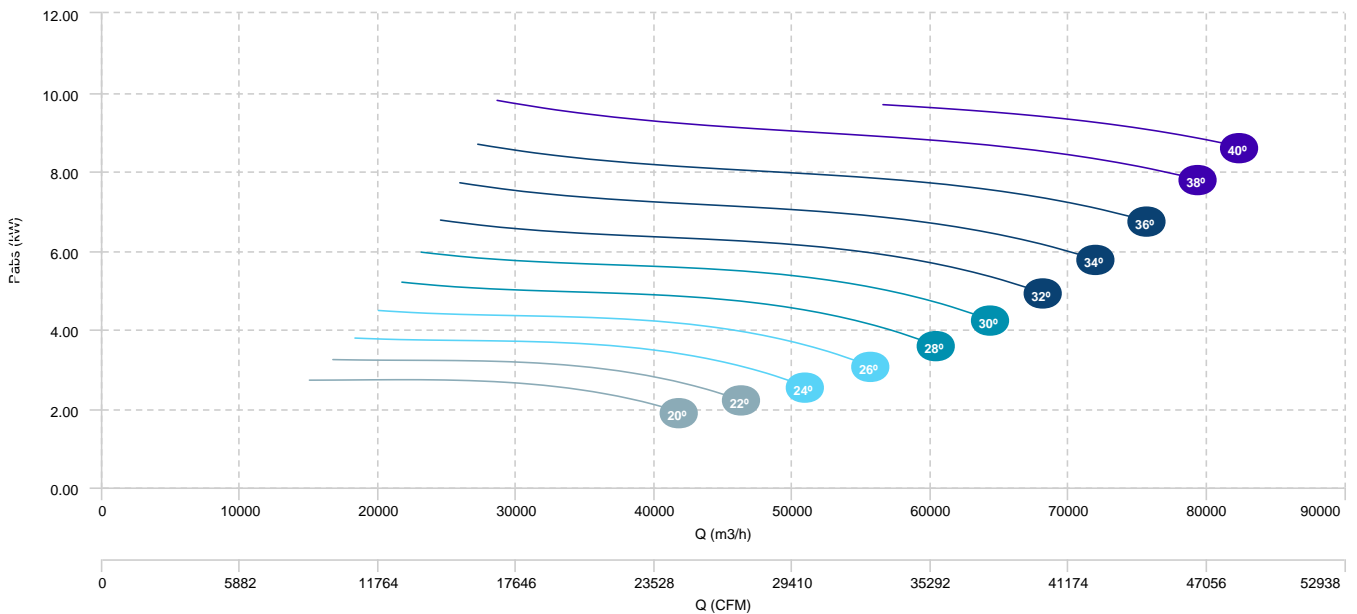

HBA 125 T4/T8 15/3,5kW (A7:8)	HBA 125 T4/T8 20/5kW (A7:8)	HBA 125 T4/T8 28/6,5kW (A7:8)
HBA 125 T4/T8 35/8kW (A7:8)	HBA 125 T4/T8 37/9,2kW (A7:8)	HBA 125 T4/T8 44/11kW (A7:8)

**AIR FLOW - PRESSURE (4 poles)**

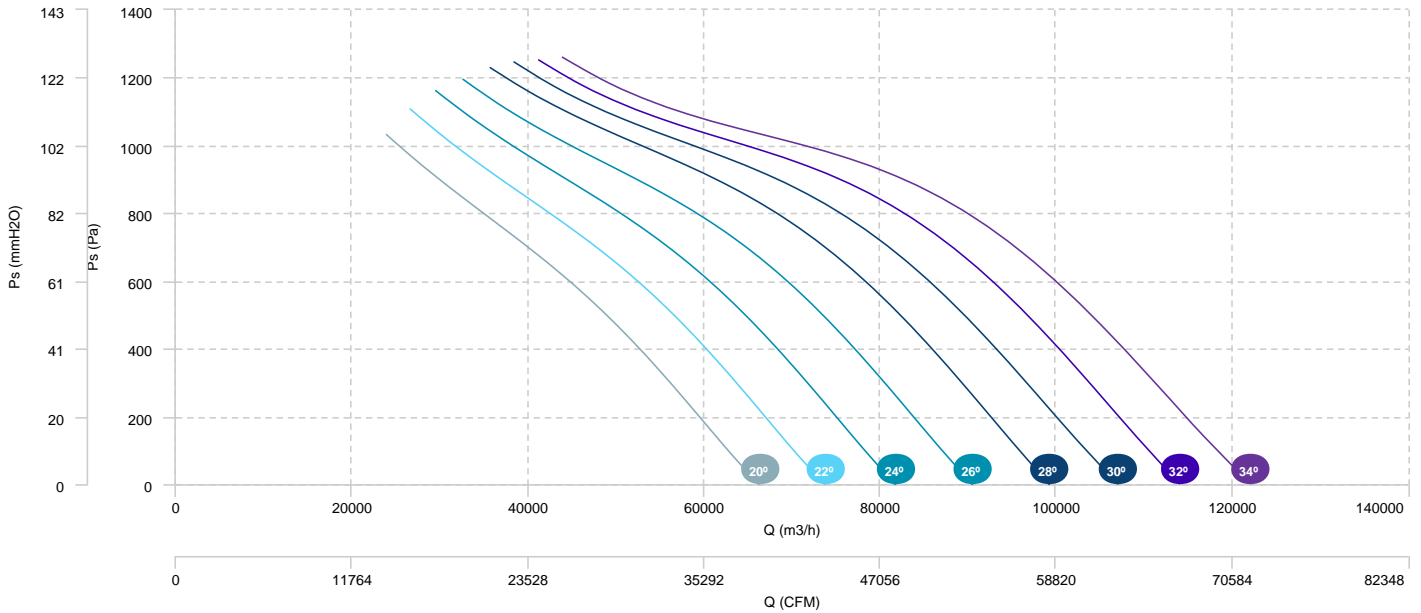

**AIR FLOW - ABSORBED POWER (4 poles)**

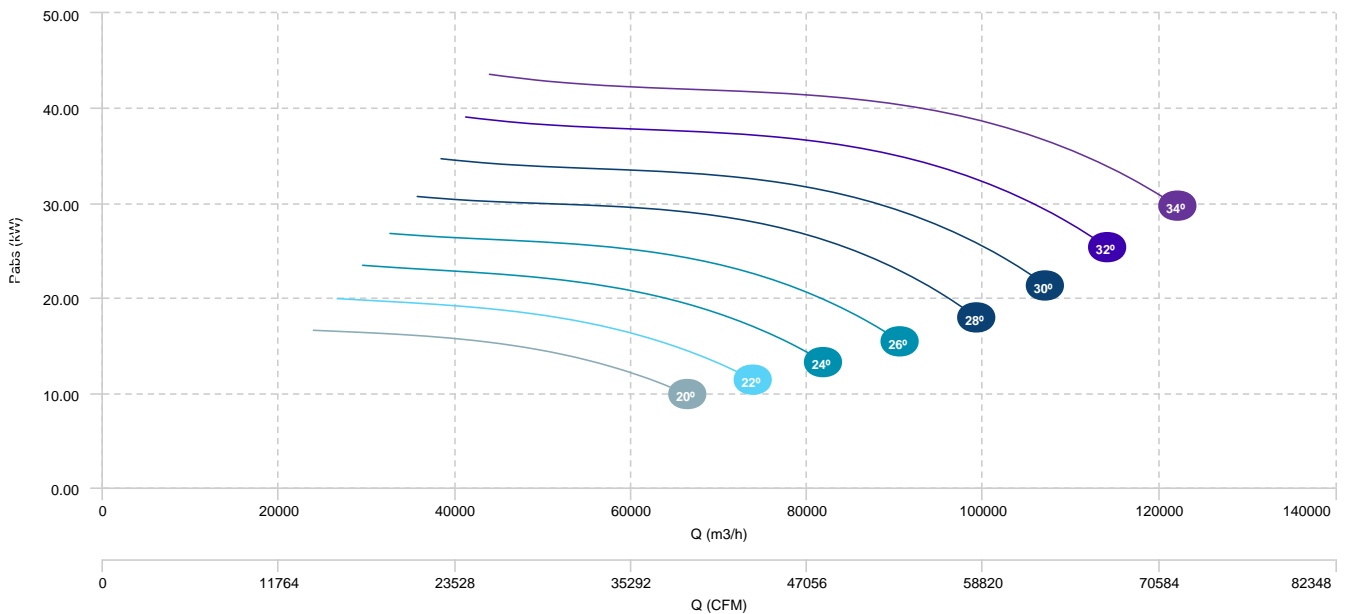

HBA 125 T4/T8 15/3,5kW (A7:8)	HBA 125 T4/T8 20/5kW (A7:8)	HBA 125 T4/T8 28/6,5kW (A7:8)
HBA 125 T4/T8 35/8kW (A7:8)	HBA 125 T4/T8 37/9,2kW (A7:8)	HBA 125 T4/T8 44/11kW (A7:8)

## AIR FLOW - PRESSURE (8 poles)

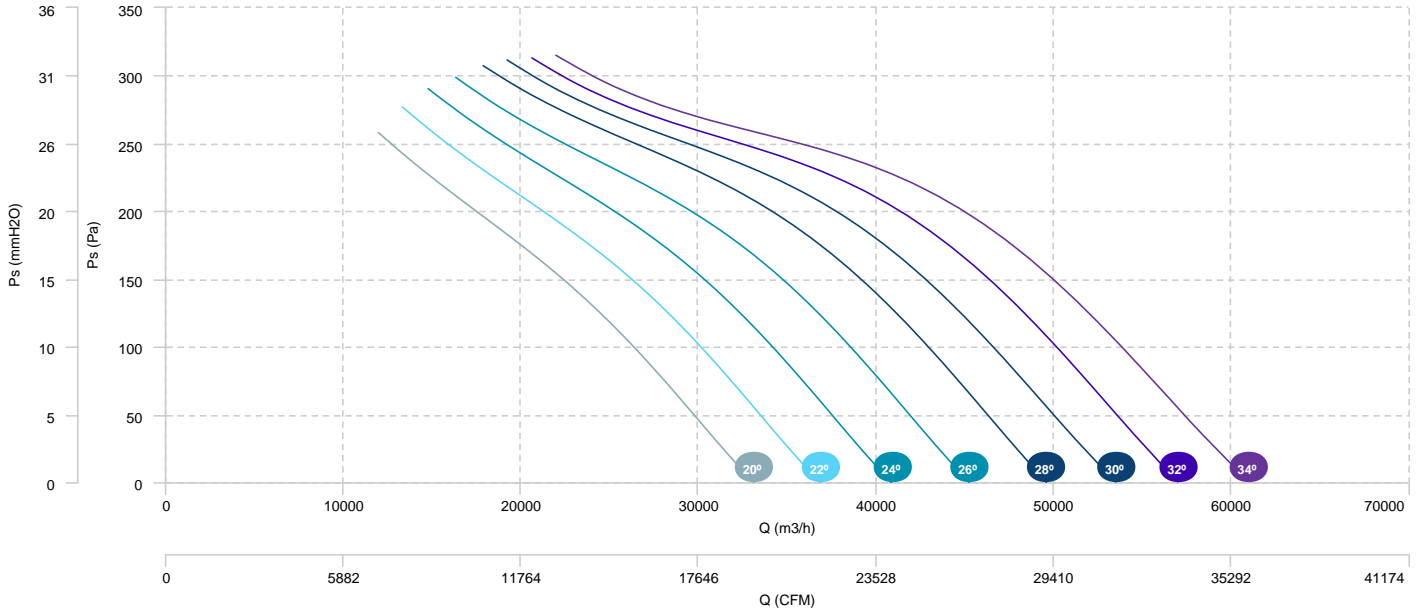

HBA 125 T4/T8 11/3kW (A7:4)	HBA 125 T4/T8 15/3,5kW (A7:4)	HBA 125 T4/T8 17/4,3kW (A7:4)
HBA 125 T4/T8 20/5kW (A7:4)	HBA 125 T4/T8 28/6,5kW (A7:4)	HBA 125 T4/T8 35/8kW (A7:4)

## AIR FLOW - PRESSURE (4 poles)

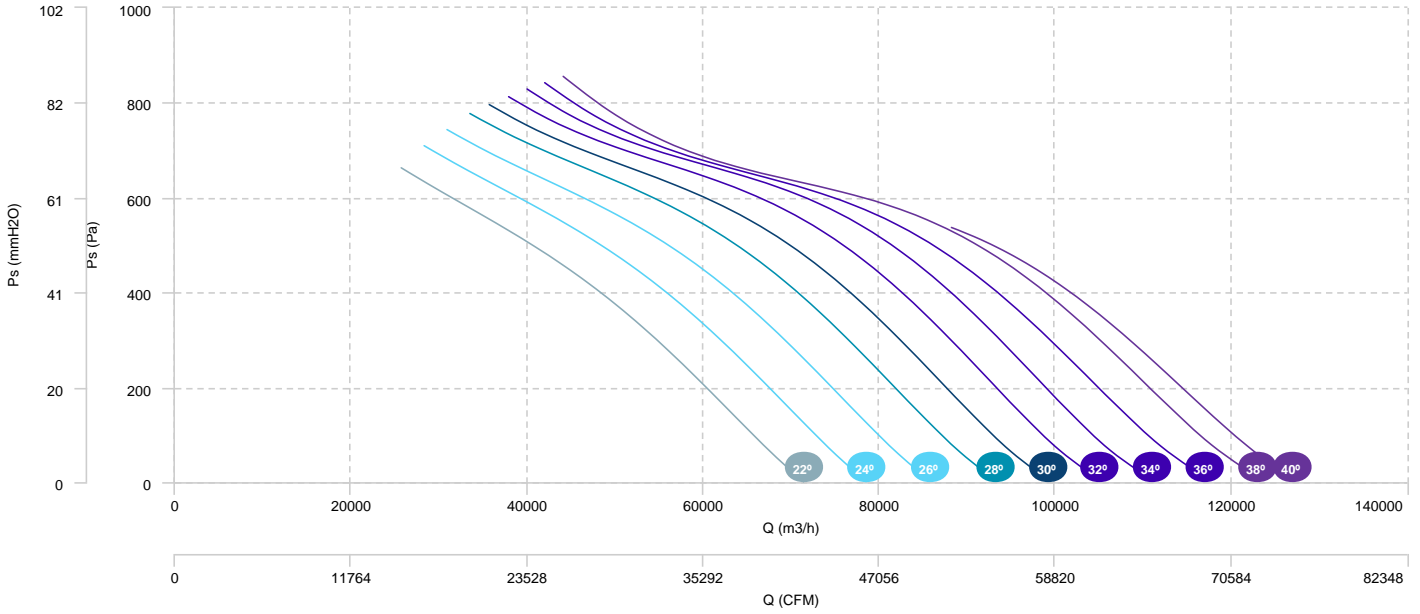

## AIR FLOW - ABSORBED POWER (4 poles)

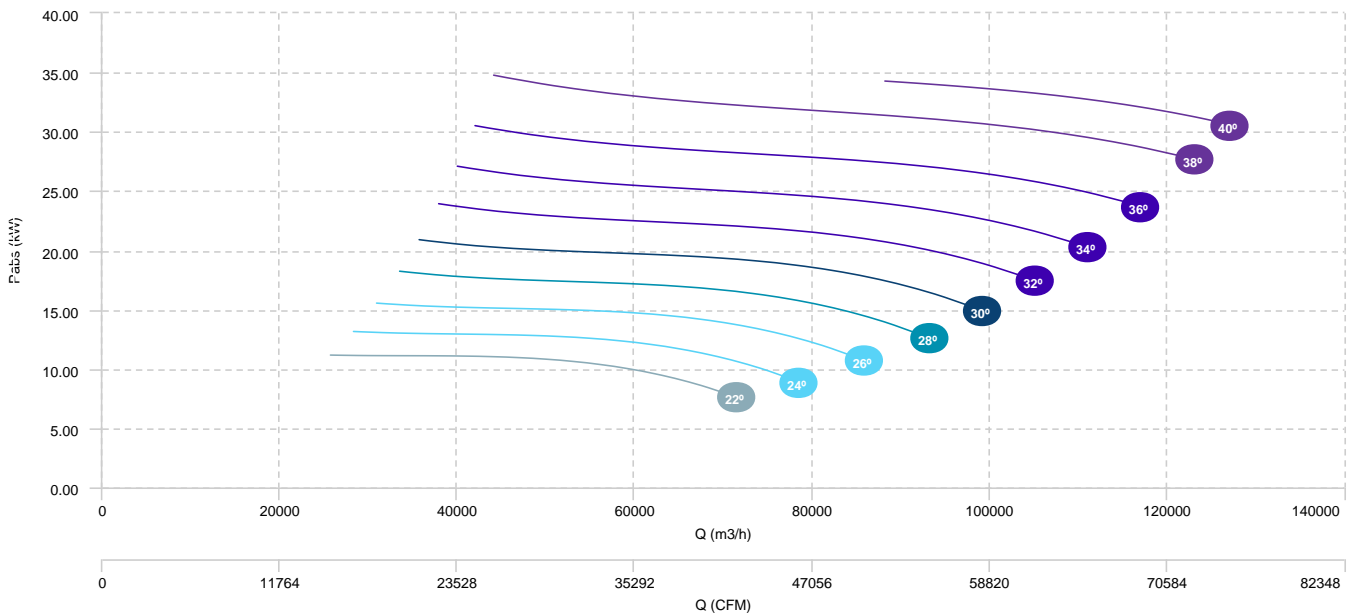

HBA 125 T4/T8 11/3kW (A7:4)	HBA 125 T4/T8 15/3,5kW (A7:4)	HBA 125 T4/T8 17/4,3kW (A7:4)
HBA 125 T4/T8 20/5kW (A7:4)	HBA 125 T4/T8 28/6,5kW (A7:4)	HBA 125 T4/T8 35/8kW (A7:4)

## AIR FLOW - PRESSURE (8 poles)

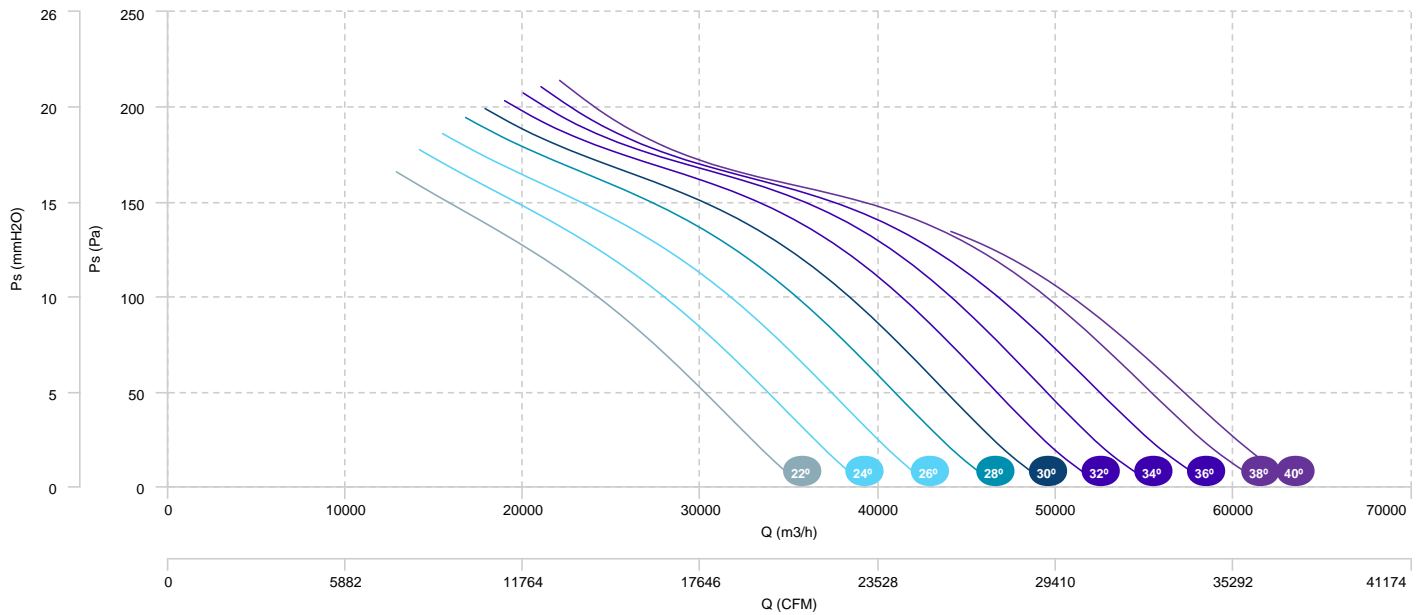

## Dane akustyczne

### Hałas / 2 poles

Sound power Lw dB (A)										
Model		63 Hz	125 Hz	250 Hz	500 Hz	1000 Hz	2000 Hz	4000 Hz	8000 Hz	Total
HBA 35 M2 0,55kW (A0:6) (30°)	Inlet	56	65	71	77	78	78	80	75	85
HBA 35 M2 1,1kW (A0:6) (35°)	Inlet	55	63	70	73	76	76	78	73	83
HBA 35 T2 0,55kW (A0:6) (30°)	Inlet	56	65	71	77	78	78	80	75	85
HBA 35 T2 1,1kW (A0:6) (35°)	Inlet	55	63	70	73	76	76	78	73	83
HBA 40 T2 1,1kW (A0:6) (30°)	Inlet	61	68	73	77	80	82	83	75	87
HBA 45 T2 1,5kW (A0:6) (25°)	Inlet	62	71	76	83	88	88	89	85	94
HBA 45 T2 2,2kW (A0:6) (35°)	Inlet	62	69	74	79	82	82	84	78	89

### Hałas / 4 poles

Sound power Lw dB (A)										
Model		63 Hz	125 Hz	250 Hz	500 Hz	1000 Hz	2000 Hz	4000 Hz	8000 Hz	Total
HBA 35 M4 0,12kW (A0:6) (40°)	Inlet	40	48	54	59	61	62	63	57	68
HBA 35 T4 0,12kW (A0:6) (40°)	Inlet	40	48	54	59	61	62	63	57	68
HBA 40 M4 0,25kW (A0:6) (40°)	Inlet	48	55	60	64	67	68	68	62	74
HBA 40 T4 0,25kW (A0:6) (40°)	Inlet	48	55	60	64	67	68	68	62	74
HBA 45 M4 0,37kW (A0:6) (40°)	Inlet	39	57	69	74	76	70	63	58	79
HBA 45 T4 0,55kW (A0:6) (45°)	Inlet	50	57	63	67	69	70	70	64	76
HBA 50 M4 0,55kW (A0:6) (40°)	Inlet	51	59	64	68	71	72	72	65	78
HBA 50 T4 0,55kW (A0:6) (45°)	Inlet	51	59	64	68	71	72	72	65	78
HBA 56 M4 0,37kW (A5:6) (20°)	Inlet	52	60	67	74	80	75	77	69	84
HBA 56 M4 0,55kW (A2:6) (25°)	Inlet	50	57	65	73	75	76	77	72	82
HBA 56 M4 0,55kW (A2:6) (20°)	Inlet	46	54	64	73	75	75	76	72	82
HBA 56 M4 0,55kW (A2:6) (25°)	Inlet	50	57	65	73	75	76	77	72	82
HBA 56 M4 0,55kW (A2:6) (20°)	Inlet	46	54	64	73	75	75	76	72	82
HBA 56 M4 0,55kW (A5:6) (25°)	Inlet	54	62	67	75	79	76	78	70	84
HBA 56 T4 0,37kW (A5:6) (20°)	Inlet	52	60	67	74	80	75	77	69	84
HBA 56 T4 0,55kW (A2:6) (25°)	Inlet	50	57	65	73	75	76	77	72	82
HBA 56 T4 0,55kW (A2:6) (20°)	Inlet	46	54	64	73	75	75	76	72	82
HBA 56 T4 0,55kW (A2:9) (20°)	Inlet	54	58	67	73	76	76	77	69	82
HBA 56 T4 0,55kW (A5:6) (25°)	Inlet	54	62	67	75	79	76	78	70	84
HBA 56 T4 0,75kW (A2:6) (33°)	Inlet	53	60	65	71	73	75	75	70	80
HBA 56 T4 0,75kW (A2:6) (30°)	Inlet	52	59	65	71	73	74	76	70	80
HBA 56 T4 0,75kW (A2:6) (28°)	Inlet	51	58	65	72	74	75	76	70	81
HBA 56 T4 0,75kW (A2:9) (25°)	Inlet	53	58	67	73	76	76	77	71	82
HBA 56 T4 0,75kW (A5:6) (33°)	Inlet	54	61	66	75	75	76	79	70	83

**Sound power Lw dB (A)**

Model		63 Hz	125 Hz	250 Hz	500 Hz	1000 Hz	2000 Hz	4000 Hz	8000 Hz	Total
HBA 56 T4 0,75kW (A5:6) (30°)	Inlet	56	63	68	77	78	78	80	72	85
HBA 56 T4 1,1kW (A2:6) (43°)	Inlet	55	61	67	72	74	76	76	70	81
HBA 56 T4 1,1kW (A2:6) (40°)	Inlet	54	61	66	71	74	75	76	70	81
HBA 56 T4 1,1kW (A2:6) (37°)	Inlet	53	60	65	71	73	75	76	70	81
HBA 56 T4 1,1kW (A2:6) (35°)	Inlet	52	59	64	71	73	75	75	70	80
HBA 56 T4 1,1kW (A2:9) (35°)	Inlet	53	59	68	73	76	77	79	73	83
HBA 56 T4 1,1kW (A2:9) (33°)	Inlet	53	59	68	73	76	77	78	73	83
HBA 56 T4 1,1kW (A2:9) (30°)	Inlet	54	59	67	73	77	77	78	73	83
HBA 56 T4 1,1kW (A2:9) (28°)	Inlet	54	59	67	73	76	77	78	72	83
HBA 56 T4 1,1kW (A5:6) (37°)	Inlet	54	61	66	75	74	76	78	69	82
HBA 56 T4 1,1kW (A5:6) (35°)	Inlet	53	60	65	74	73	75	78	69	82
HBA 56 T4 1,5kW (A2:6) (45°)	Inlet	56	60	68	72	75	77	76	71	82
HBA 56 T4 1,5kW (A2:9) (43°)	Inlet	53	60	69	73	76	77	78	72	83
HBA 56 T4 1,5kW (A2:9) (40°)	Inlet	53	60	69	73	76	77	78	72	83
HBA 56 T4 1,5kW (A2:9) (37°)	Inlet	53	59	68	73	76	77	78	73	83
HBA 56 T4 1,5kW (A5:6) (40°)	Inlet	56	63	68	76	75	76	79	70	83
HBA 63 T4 0,55kW (A2:6) (20°)	Inlet	49	51	64	74	73	73	75	70	80
HBA 63 T4 0,75kW (A2:6) (25°)	Inlet	53	58	67	75	76	77	78	73	83
HBA 63 T4 0,75kW (A2:9) (20°)	Inlet	57	60	71	77	78	77	79	74	85
HBA 63 T4 0,75kW (A5:6) (25°)	Inlet	57	66	71	80	80	79	80	75	86
HBA 63 T4 1,1kW (A2:6) (33°)	Inlet	53	61	66	73	75	77	77	72	82
HBA 63 T4 1,1kW (A2:6) (30°)	Inlet	53	60	66	74	75	77	78	73	83
HBA 63 T4 1,1kW (A2:6) (28°)	Inlet	53	59	67	74	76	77	78	73	83
HBA 63 T4 1,1kW (A2:9) (25°)	Inlet	57	61	70	76	78	78	80	74	85
HBA 63 T4 1,1kW (A5:6) (30°)	Inlet	60	68	74	80	80	79	82	77	87
HBA 63 T4 1,5kW (A2:6) (40°)	Inlet	55	62	67	73	76	77	77	72	83
HBA 63 T4 1,5kW (A2:6) (37°)	Inlet	54	61	66	73	75	77	77	72	82
HBA 63 T4 1,5kW (A2:6) (35°)	Inlet	53	60	65	72	74	77	77	72	82
HBA 63 T4 1,5kW (A2:9) (33°)	Inlet	57	63	70	77	79	80	81	75	86
HBA 63 T4 1,5kW (A2:9) (30°)	Inlet	58	63	70	76	78	80	81	75	86
HBA 63 T4 1,5kW (A2:9) (28°)	Inlet	58	62	70	76	78	79	80	75	85
HBA 63 T4 1,5kW (A5:6) (35°)	Inlet	59	67	72	75	76	76	79	73	83
HBA 63 T4 1,5kW (A5:6) (33°)	Inlet	59	68	73	77	78	77	80	75	85
HBA 63 T4 2,2kW (A2:6) (45°)	Inlet	58	62	70	74	78	78	78	72	84
HBA 63 T4 2,2kW (A2:6) (43°)	Inlet	56	62	68	74	76	78	78	72	83
HBA 63 T4 2,2kW (A2:9) (43°)	Inlet	57	64	69	76	79	80	81	76	86
HBA 63 T4 2,2kW (A2:9) (40°)	Inlet	57	63	69	76	79	80	80	76	86
HBA 63 T4 2,2kW (A2:9) (37°)	Inlet	57	63	70	76	79	80	81	76	86
HBA 63 T4 2,2kW (A2:9) (35°)	Inlet	57	63	70	77	79	80	81	76	86

**Sound power Lw dB (A)**

Model		63 Hz	125 Hz	250 Hz	500 Hz	1000 Hz	2000 Hz	4000 Hz	8000 Hz	Total
HBA 63 T4 2,2kW (A5:6) (37°)	Inlet	59	67	72	76	77	77	79	73	84
HBA 63 T4 2,2kW (A5:6) (40°)	Inlet	60	67	72	77	78	78	80	73	85
HBA 63 T4 3kW (A2:9) (45°)	Inlet	57	64	69	76	78	80	81	75	86
HBA 71 T4 0,75KW (A2:6) (20°)	Inlet	55	61	72	79	83	82	84	78	89
HBA 71 T4 0,75kW (A5:6) (20°)	Inlet	55	66	71	86	85	82	84	76	91
HBA 71 T4 1,1kW (A2:6) (25°)	Inlet	57	63	71	79	81	82	83	77	88
HBA 71 T4 1,1kW (A2:9) (20°)	Inlet	60	66	75	83	85	85	87	79	91
HBA 71 T4 1,1kW (A5:6) (25°)	Inlet	59	67	72	84	84	82	84	75	90
HBA 71 T4 1,5kW (A2:6) (33°)	Inlet	57	64	69	76	78	80	81	75	86
HBA 71 T4 1,5kW (A2:6) (30°)	Inlet	58	64	70	78	79	81	82	77	87
HBA 71 T4 1,5kW (A2:6) (28°)	Inlet	57	64	70	78	80	81	82	77	87
HBA 71 T4 1,5kW (A2:9) (25°)	Inlet	60	67	74	81	83	84	85	79	90
HBA 71 T4 1,5kW (A5:6) (30°)	Inlet	61	68	73	82	82	83	84	73	89
HBA 71 T4 2,2kW (A2:6) (40°)	Inlet	59	66	71	77	80	81	80	74	86
HBA 71 T4 2,2kW (A2:6) (37°)	Inlet	58	65	70	76	78	80	80	74	85
HBA 71 T4 2,2kW (A2:6) (35°)	Inlet	57	64	69	75	77	79	80	74	85
HBA 71 T4 2,2kW (A2:9) (33°)	Inlet	60	67	72	79	82	83	83	78	89
HBA 71 T4 2,2kW (A2:9) (30°)	Inlet	60	67	72	79	82	83	84	78	89
HBA 71 T4 2,2kW (A2:9) (28°)	Inlet	60	67	73	80	82	83	84	78	89
HBA 71 T4 2,2kW (A5:6) (35°)	Inlet	62	69	74	76	80	82	83	72	87
HBA 71 T4 2,2kW (A5:6) (33°)	Inlet	62	69	74	79	81	83	84	73	88
HBA 71 T4 3kW (A2:6) (45°)	Inlet	62	66	74	77	80	81	81	74	86
HBA 71 T4 3kW (A2:6) (43°)	Inlet	60	66	72	77	80	81	80	74	86
HBA 71 T4 3kW (A2:9) (37°)	Inlet	61	68	73	79	82	83	83	78	89
HBA 71 T4 3kW (A2:9) (35°)	Inlet	60	67	72	79	82	83	83	78	89
HBA 71 T4 3kW (A5:6) (40°)	Inlet	67	73	79	81	84	85	86	76	91
HBA 71 T4 3kW (A5:6) (37°)	Inlet	65	71	77	79	82	84	85	74	89
HBA 80 T4 1,1KW (A2:6) (20°)	Inlet	54	61	71	79	83	83	84	79	89
HBA 80 T4 1,5KW (A2:6) (25°)	Inlet	57	64	72	79	83	83	84	79	89
HBA 80 T4 1,5KW (A2:9) (20°)	Inlet	60	72	77	89	91	89	92	84	97
HBA 80 T4 2,2kW (A2:6) (33°)	Inlet	61	68	73	79	82	84	84	77	89
HBA 80 T4 2,2kW (A2:6) (30°)	Inlet	60	67	72	79	82	84	84	78	89
HBA 80 T4 2,2kW (A2:6) (28°)	Inlet	60	67	72	79	82	84	84	78	89
HBA 80 T4 2,2kW (A2:9) (25°)	Inlet	62	71	76	86	89	88	90	83	95
HBA 80 T4 3kW (A2:6) (37°)	Inlet	62	69	74	78	81	83	83	76	88
HBA 80 T4 3kW (A2:6) (35°)	Inlet	62	69	74	78	81	84	84	77	89
HBA 80 T4 3kW (A2:9) (30°)	Inlet	63	70	75	84	87	88	88	82	93
HBA 80 T4 3kW (A2:9) (28°)	Inlet	63	71	76	85	88	88	89	82	94
HBA 80 T4 3kW (A5:6) (35°)	Inlet	62	69	74	79	82	82	86	76	89



**Sound power Lw dB (A)**

Model		63 Hz	125 Hz	250 Hz	500 Hz	1000 Hz	2000 Hz	4000 Hz	8000 Hz	Total
HBA 80 T4 3kW (A5:6) (33°)	Inlet	63	70	75	81	85	84	88	80	91
HBA 80 T4 3kW (A5:6) (30°)	Inlet	64	71	76	83	87	86	90	83	94
HBA 80 T4 4kW (A2:6) (43°)	Inlet	62	69	75	78	81	82	82	75	88
HBA 80 T4 4kW (A2:6) (40°)	Inlet	61	69	74	78	81	82	82	75	88
HBA 80 T4 4kW (A2:9) (35°)	Inlet	62	69	74	81	85	87	86	80	92
HBA 80 T4 4kW (A2:9) (33°)	Inlet	63	70	75	83	86	87	87	81	93
HBA 80 T4 4kW (A5:6) (37°)	Inlet	64	71	76	80	83	83	86	76	90
HBA 80 T4 4kW (A5:6) (40°)	Inlet	66	73	78	82	84	84	86	76	91
HBA 80 T4 5,5kW (A2:6) (45°)	Inlet	62	69	75	79	82	82	82	75	88
HBA 80 T4 5,5kW (A2:9) (43°)	Inlet	64	71	76	81	84	86	85	79	91
HBA 80 T4 5,5kW (A2:9) (40°)	Inlet	64	71	76	81	84	86	85	79	91
HBA 80 T4 5,5kW (A2:9) (37°)	Inlet	63	70	75	81	85	87	86	80	91
HBA 90 T4 3kW (A6:3) (22°)	Inlet	61	65	73	77	81	82	85	79	89
HBA 90 T4 3kW (A6:3) (20°)	Inlet	60	63	72	75	79	80	84	78	87
HBA 90 T4 4kW (A6:3) (28°)	Inlet	64	69	77	82	84	85	87	82	92
HBA 90 T4 4kW (A6:3) (26°)	Inlet	63	68	76	81	83	84	87	81	91
HBA 90 T4 4kW (A6:3) (24°)	Inlet	62	67	75	79	82	83	86	80	90
HBA 90 T4 5,5kW (A6:3) (32°)	Inlet	65	71	78	86	86	87	88	83	94
HBA 90 T4 5,5kW (A6:3) (30°)	Inlet	65	71	78	84	85	86	88	82	93
HBA 90 T4 5,5kW (A6:6) (22°)	Inlet	66	75	81	89	92	91	91	86	97
HBA 90 T4 5,5kW (A6:6) (20°)	Inlet	65	75	81	88	92	90	91	86	97
HBA 90 T4 7,5kW (A6:3) (36°)	Inlet	66	72	79	88	87	89	89	84	95
HBA 90 T4 7,5kW (A6:3) (34°)	Inlet	66	72	79	87	87	88	89	83	94
HBA 90 T4 7,5kW (A6:6) (28°)	Inlet	68	77	83	90	92	92	93	88	98
HBA 90 T4 7,5kW (A6:6) (26°)	Inlet	67	77	82	90	92	91	92	88	98
HBA 90 T4 7,5kW (A6:6) (24°)	Inlet	67	76	82	89	92	91	92	87	98
HBA 90 T4 11kW (A6:3) (40°)	Inlet	66	74	81	89	90	91	91	86	97
HBA 90 T4 11kW (A6:3) (38°)	Inlet	66	73	80	89	89	90	90	85	96
HBA 90 T4 11kW (A6:6) (34°)	Inlet	66	75	80	87	88	89	91	85	95
HBA 90 T4 11kW (A6:6) (32°)	Inlet	68	77	82	89	90	90	92	87	97
HBA 90 T4 11kW (A6:6) (30°)	Inlet	69	78	83	90	92	92	93	89	99
HBA 90 T4 15kW (A6:6) (40°)	Inlet	68	76	81	88	89	90	91	85	96
HBA 90 T4 15kW (A6:6) (38°)	Inlet	67	76	81	87	88	89	91	85	96
HBA 90 T4 15kW (A6:6) (36°)	Inlet	66	75	80	86	88	89	90	85	95
HBA 100 T4 5,5kW (A6:3) (26°)	Inlet	66	72	78	83	87	88	91	84	94
HBA 100 T4 5,5kW (A6:3) (24°)	Inlet	66	72	78	83	87	88	91	85	95
HBA 100 T4 5,5kW (A6:3) (22°)	Inlet	64	71	76	81	87	88	92	84	95
HBA 100 T4 5,5kW (A6:3) (20°)	Inlet	64	71	76	81	87	88	92	84	95
HBA 100 T4 7,5kW (A6:3) (30°)	Inlet	66	72	78	84	86	87	89	83	94

**Sound power Lw dB (A)**

Model		63 Hz	125 Hz	250 Hz	500 Hz	1000 Hz	2000 Hz	4000 Hz	8000 Hz	Total
HBA 100 T4 7,5kW (A6:3) (28°)	Inlet	66	72	78	83	86	88	90	84	94
HBA 100 T4 7,5kW (A6:6) (22°)	Inlet	69	80	85	95	95	95	95	91	102
HBA 100 T4 7,5kW (A6:6) (20°)	Inlet	69	80	85	95	96	95	95	91	102
HBA 100 T4 11kW (A6:3) (36°)	Inlet	69	75	82	88	90	90	91	86	96
HBA 100 T4 11kW (A6:3) (34°)	Inlet	69	75	81	87	89	90	90	85	96
HBA 100 T4 11kW (A6:3) (32°)	Inlet	68	73	80	85	87	88	90	84	95
HBA 100 T4 11kW (A6:6) (28°)	Inlet	73	81	87	95	95	95	96	92	103
HBA 100 T4 11kW (A6:6) (26°)	Inlet	71	81	86	94	95	95	96	91	102
HBA 100 T4 11kW (A6:6) (24°)	Inlet	70	80	85	94	95	95	95	91	102
HBA 100 T4 15kW (A6:3) (40°)	Inlet	69	77	82	90	91	92	92	87	98
HBA 100 T4 15kW (A6:3) (38°)	Inlet	69	76	82	89	90	91	91	86	97
HBA 100 T4 15kW (A6:6) (32°)	Inlet	72	80	86	92	94	94	95	90	101
HBA 100 T4 15kW (A6:6) (30°)	Inlet	73	81	87	94	95	95	97	92	102
HBA 100 T4 18,5kW (A6:6) (36°)	Inlet	71	79	85	89	92	92	94	88	99
HBA 100 T4 18,5kW (A6:6) (34°)	Inlet	72	80	86	90	92	93	94	89	99
HBA 100 T4 22kW (A6:6) (40°)	Inlet	73	81	86	91	93	94	95	89	101
HBA 100 T4 22kW (A6:6) (38°)	Inlet	72	80	86	90	92	93	94	89	99
HBA 112 T4 5,5kW (A6:3) (22°)	Inlet	69	76	81	87	92	93	95	90	99
HBA 112 T4 5,5kW (A6:3) (20°)	Inlet	67	74	79	86	91	92	94	89	99
HBA 112 T4 7,5kW (A6:3) (26°)	Inlet	71	77	83	89	92	93	96	90	100
HBA 112 T4 7,5kW (A6:3) (24°)	Inlet	70	77	82	88	92	93	95	90	100
HBA 112 T4 11kW (A6:3) (30°)	Inlet	71	77	83	89	92	92	95	90	99
HBA 112 T4 11kW (A6:3) (28°)	Inlet	71	77	83	89	92	93	95	90	100
HBA 112 T4 11kW (A6:6) (22°)	Inlet	70	80	86	96	98	97	98	93	104
HBA 112 T4 11kW (A6:6) (20°)	Inlet	69	80	86	97	98	97	98	93	104
HBA 112 T4 15kW (A6:3) (36°)	Inlet	73	78	85	90	92	93	94	90	99
HBA 112 T4 15kW (A6:3) (34°)	Inlet	73	77	85	90	92	92	94	90	99
HBA 112 T4 15kW (A6:3) (32°)	Inlet	72	77	84	89	92	92	94	90	99
HBA 112 T4 15kW (A6:6) (28°)	Inlet	74	82	87	95	97	97	98	92	104
HBA 112 T4 15kW (A6:6) (26°)	Inlet	72	81	86	95	97	97	98	92	104
HBA 112 T4 15kW (A6:6) (24°)	Inlet	71	80	86	95	97	96	97	92	103
HBA 112 T4 18,5kW (A6:3) (38°)	Inlet	73	79	85	91	93	93	94	90	100
HBA 112 T4 18,5kW (A6:6) (30°)	Inlet	75	82	87	94	96	97	98	91	103
HBA 112 T4 22kW (A6:3) (40°)	Inlet	73	79	85	91	93	94	94	90	100
HBA 112 T4 22kW (A6:6) (34°)	Inlet	74	81	86	91	94	95	96	89	101
HBA 112 T4 22kW (A6:6) (32°)	Inlet	74	81	86	92	95	96	97	90	102
HBA 112 T4 30kW (A6:6) (40°)	Inlet	78	85	90	94	97	98	99	92	104
HBA 112 T4 30kW (A6:6) (38°)	Inlet	77	83	89	92	96	97	98	91	103
HBA 112 T4 30kW (A6:6) (36°)	Inlet	75	82	87	91	94	95	96	89	102

**Sound power Lw dB (A)**

Model		63 Hz	125 Hz	250 Hz	500 Hz	1000 Hz	2000 Hz	4000 Hz	8000 Hz	Total
HBA 125 T4 11kW (A7:4) (22°)	Inlet	75	86	91	98	102	103	105	101	109
HBA 125 T4 11kW (A7:4) (20°)	Inlet	72	85	90	98	102	102	104	101	109
HBA 125 T4 15kW (A7:4) (26°)	Inlet	76	84	89	94	98	99	101	95	106
HBA 125 T4 15kW (A7:4) (24°)	Inlet	75	85	90	96	100	101	103	98	107
HBA 125 T4 15kW (A7:8) (20°)	Inlet	77	85	92	101	107	110	109	104	115
HBA 125 T4 18,5kW (A7:4) (30°)	Inlet	74	81	86	90	94	96	97	90	102
HBA 125 T4 18,5kW (A7:4) (28°)	Inlet	75	82	87	92	96	98	99	93	104
HBA 125 T4 18,5kW (A7:8) (22°)	Inlet	77	85	91	99	106	109	108	103	113
HBA 125 T4 22kW (A7:4) (32°)	Inlet	74	81	86	90	93	95	96	89	101
HBA 125 T4 22kW (A7:8) (24°)	Inlet	77	84	91	98	105	107	107	101	112
HBA 125 T4 30kW (A7:4) (36°)	Inlet	74	81	86	90	93	95	96	88	101
HBA 125 T4 30kW (A7:4) (34°)	Inlet	73	80	85	90	93	95	96	88	101
HBA 125 T4 30kW (A7:8) (28°)	Inlet	77	83	90	96	102	105	105	98	110
HBA 125 T4 30kW (A7:8) (26°)	Inlet	77	84	90	97	103	106	106	99	111
HBA 125 T4 37kW (A7:4) (40°)	Inlet	75	82	87	92	94	96	96	90	102
HBA 125 T4 37kW (A7:4) (38°)	Inlet	75	82	87	91	94	96	96	89	102
HBA 125 T4 37kW (A7:8) (32°)	Inlet	77	83	89	94	99	101	102	94	106
HBA 125 T4 37kW (A7:8) (30°)	Inlet	77	83	89	95	100	103	103	96	108
HBA 125 T4 45kW (A7:8) (36°)	Inlet	77	84	89	94	97	99	99	91	105
HBA 125 T4 45kW (A7:8) (34°)	Inlet	77	83	89	94	98	100	100	92	105

**Hałas / 6 poles**
**Sound power Lw dB (A)**

Model		63 Hz	125 Hz	250 Hz	500 Hz	1000 Hz	2000 Hz	4000 Hz	8000 Hz	Total
HBA 40 M6 0,04kW (A0:6) (35°)	Inlet	35	42	48	51	54	56	57	50	62
HBA 40 T6 0,12kW (A0:6) (35°)	Inlet	35	42	48	51	54	56	57	50	62
HBA 45 M6 0,13kW (A0:6) (45°)	Inlet	41	48	53	57	60	61	61	54	67
HBA 45 T6 0,13kW (A0:6) (45°)	Inlet	41	48	53	57	60	61	61	54	67
HBA 50 M6 0,13kW (A0:6) (45°)	Inlet	42	49	55	59	62	62	62	56	69
HBA 50 T6 0,13kW (A0:6) (45°)	Inlet	42	49	55	59	62	62	62	56	69
HBA 56 M6 0,25kW (A2:6) (35°)	Inlet	43	50	55	61	63	65	66	61	71
HBA 56 M6 0,25kW (A2:6) (37°)	Inlet	44	51	56	62	64	66	66	60	71
HBA 56 M6 0,25kW (A2:6) (33°)	Inlet	43	50	55	61	63	65	66	61	71
HBA 56 M6 0,25kW (A2:6) (30°)	Inlet	42	49	55	61	64	65	66	60	71
HBA 56 M6 0,25kW (A2:6) (28°)	Inlet	42	49	56	62	64	65	66	61	71
HBA 56 M6 0,25kW (A2:6) (25°)	Inlet	40	48	56	64	66	66	67	62	73
HBA 56 M6 0,25kW (A2:6) (20°)	Inlet	37	45	54	64	65	66	67	62	72
HBA 56 M6 0,25kW (A2:6) (35°)	Inlet	43	50	55	61	63	65	66	61	71

**Sound power Lw dB (A)**

Model		63 Hz	125 Hz	250 Hz	500 Hz	1000 Hz	2000 Hz	4000 Hz	8000 Hz	Total
HBA 56 M6 0,25kW (A2:6) (37°)	Inlet	44	51	56	62	64	66	66	60	71
HBA 56 M6 0,25kW (A2:6) (33°)	Inlet	43	50	55	61	63	65	66	61	71
HBA 56 M6 0,25kW (A2:6) (30°)	Inlet	42	49	55	61	64	65	66	60	71
HBA 56 M6 0,25kW (A2:6) (28°)	Inlet	42	49	56	62	64	65	66	61	71
HBA 56 M6 0,25kW (A2:6) (25°)	Inlet	40	48	56	64	66	66	67	62	73
HBA 56 M6 0,25kW (A2:6) (20°)	Inlet	37	45	54	64	65	66	67	62	72
HBA 56 M6 0,25kW (A5:6) (35°)	Inlet	44	51	56	65	64	66	69	60	73
HBA 56 M6 0,25kW (A5:6) (33°)	Inlet	46	53	58	67	66	67	70	62	74
HBA 56 M6 0,25kW (A5:6) (30°)	Inlet	47	54	59	68	69	69	71	63	76
HBA 56 M6 0,37kW (A2:6) (45°)	Inlet	47	50	59	63	66	67	67	61	72
HBA 56 M6 0,37kW (A2:6) (43°)	Inlet	45	51	57	62	65	66	67	60	72
HBA 56 M6 0,37kW (A2:6) (40°)	Inlet	45	52	57	62	64	66	67	60	72
HBA 56 M6 0,37kW (A5:6) (37°)	Inlet	46	53	58	66	65	67	69	61	73
HBA 56 M6 0,37kW (A5:6) (40°)	Inlet	47	54	59	67	66	67	70	61	74
HBA 56 T6 0,25kW (A5:6) (35°)	Inlet	44	51	56	65	64	66	69	60	73
HBA 56 T6 0,25kW (A5:6) (33°)	Inlet	46	53	58	67	66	67	70	62	74
HBA 56 T6 0,25kW (A5:6) (30°)	Inlet	47	54	59	68	69	69	71	63	76
HBA 56 T6 0,37kW (A5:6) (37°)	Inlet	46	53	58	66	65	67	69	61	73
HBA 56 T6 0,37kW (A5:6) (40°)	Inlet	47	54	59	67	66	67	70	61	74
HBA 56 T6 0,55kW (A2:6) (20°)	Inlet	37	45	54	64	65	66	67	62	72
HBA 56 T6 0,55kW (A2:6) (25°)	Inlet	40	48	56	64	66	66	67	62	73
HBA 56 T6 0,55kW (A2:6) (28°)	Inlet	42	49	56	62	64	65	66	61	71
HBA 56 T6 0,55kW (A2:6) (30°)	Inlet	42	49	55	61	64	65	66	60	71
HBA 56 T6 0,55kW (A2:6) (33°)	Inlet	43	50	55	61	63	65	66	61	71
HBA 56 T6 0,55kW (A2:6) (35°)	Inlet	43	50	55	61	63	65	66	61	71
HBA 56 T6 0,55kW (A2:6) (37°)	Inlet	44	51	56	62	64	66	66	60	71
HBA 56 T6 0,55kW (A2:6) (40°)	Inlet	45	52	57	62	64	66	67	60	72
HBA 56 T6 0,55kW (A2:6) (43°)	Inlet	45	51	57	62	65	66	67	60	72
HBA 56 T6 0,55kW (A2:6) (45°)	Inlet	47	50	59	63	66	67	67	61	72
HBA 56 T6 0,55kW (A2:9) (30°)	Inlet	44	50	58	64	67	68	69	63	74
HBA 56 T6 0,55kW (A2:9) (28°)	Inlet	44	49	58	64	67	67	68	63	74
HBA 56 T6 0,55kW (A2:9) (25°)	Inlet	44	49	57	64	67	67	68	61	73
HBA 56 T6 0,55kW (A2:9) (20°)	Inlet	44	49	57	64	67	67	67	60	73
HBA 56 T6 0,55kW (A2:9) (40°)	Inlet	44	50	59	63	67	67	68	63	73
HBA 56 T6 0,55kW (A2:9) (37°)	Inlet	43	50	59	64	67	67	69	63	74
HBA 56 T6 0,55kW (A2:9) (35°)	Inlet	43	49	58	64	67	68	69	63	74
HBA 56 T6 0,55kW (A2:9) (33°)	Inlet	44	49	58	64	67	68	69	63	74
HBA 56 T6 0,55kW (A2:9) (45°)	Inlet	44	51	61	64	67	68	68	63	74
HBA 56 T6 0,55kW (A2:9) (43°)	Inlet	44	50	60	63	67	67	68	63	74

**Sound power Lw dB (A)**

Model		63 Hz	125 Hz	250 Hz	500 Hz	1000 Hz	2000 Hz	4000 Hz	8000 Hz	Total
HBA 63 M6 0,37kW (A5:6) (35°)	Inlet	50	58	63	66	67	67	70	64	75
HBA 63 M6 0,55kW (A2:9) (37°)	Inlet	48	54	60	67	69	71	71	66	76
HBA 63 M6 0,55kW (A2:9) (35°)	Inlet	47	54	61	67	69	71	72	66	77
HBA 63 M6 0,55kW (A2:9) (33°)	Inlet	48	53	61	67	69	70	71	66	76
HBA 63 M6 0,55kW (A2:9) (30°)	Inlet	48	53	60	67	69	70	71	66	76
HBA 63 M6 0,55kW (A2:9) (28°)	Inlet	48	53	60	67	69	70	71	66	76
HBA 63 M6 0,55kW (A2:9) (25°)	Inlet	48	51	60	67	69	69	70	65	75
HBA 63 M6 0,55kW (A2:9) (20°)	Inlet	48	50	61	67	69	68	70	65	75
HBA 63 M6 0,55kW (A5:6) (37°)	Inlet	50	58	63	67	68	68	71	64	75
HBA 63 M6 0,55kW (A5:6) (40°)	Inlet	51	58	63	68	69	69	71	64	76
HBA 63 T6 0,37kW (A5:6) (35°)	Inlet	50	58	63	66	67	67	70	64	75
HBA 63 T6 0,55kW (A2:6) (45°)	Inlet	49	53	61	65	68	69	69	63	75
HBA 63 T6 0,55kW (A2:6) (43°)	Inlet	47	52	59	64	67	68	68	63	74
HBA 63 T6 0,55kW (A2:6) (40°)	Inlet	46	52	58	64	66	68	68	62	73
HBA 63 T6 0,55kW (A2:6) (37°)	Inlet	45	52	57	63	66	68	68	62	73
HBA 63 T6 0,55kW (A2:6) (35°)	Inlet	44	51	56	63	65	67	68	62	73
HBA 63 T6 0,55kW (A2:6) (33°)	Inlet	44	51	56	64	65	68	68	63	73
HBA 63 T6 0,55kW (A2:6) (30°)	Inlet	44	51	57	64	66	68	68	64	73
HBA 63 T6 0,55kW (A2:6) (28°)	Inlet	44	50	57	65	66	68	68	64	74
HBA 63 T6 0,55kW (A2:6) (25°)	Inlet	43	48	58	66	67	68	69	64	74
HBA 63 T6 0,55kW (A2:6) (20°)	Inlet	39	42	54	64	64	64	66	60	71
HBA 63 T6 0,55kW (A2:9) (37°)	Inlet	48	54	60	67	69	71	71	66	76
HBA 63 T6 0,55kW (A2:9) (35°)	Inlet	47	54	61	67	69	71	72	66	77
HBA 63 T6 0,55kW (A2:9) (33°)	Inlet	48	53	61	67	69	70	71	66	76
HBA 63 T6 0,55kW (A2:9) (30°)	Inlet	48	53	60	67	69	70	71	66	76
HBA 63 T6 0,55kW (A2:9) (28°)	Inlet	48	53	60	67	69	70	71	66	76
HBA 63 T6 0,55kW (A2:9) (25°)	Inlet	48	51	60	67	69	69	70	65	75
HBA 63 T6 0,55kW (A2:9) (20°)	Inlet	48	50	61	67	69	68	70	65	75
HBA 63 T6 0,55kW (A5:6) (37°)	Inlet	50	58	63	67	68	68	71	64	75
HBA 63 T6 0,55kW (A5:6) (40°)	Inlet	51	58	63	68	69	69	71	64	76
HBA 63 T6 0,75kW (A2:9) (45°)	Inlet	47	54	59	66	69	70	71	66	76
HBA 63 T6 0,75kW (A2:9) (43°)	Inlet	47	54	59	66	69	70	71	66	76
HBA 63 T6 0,75kW (A2:9) (40°)	Inlet	48	54	60	66	69	70	71	66	76
HBA 71 M6 0,55kW (A2:6) (37°)	Inlet	49	56	61	66	69	71	71	65	76
HBA 71 M6 0,55kW (A2:6) (35°)	Inlet	47	54	59	66	68	70	71	64	75
HBA 71 M6 0,55kW (A2:6) (33°)	Inlet	48	55	60	67	69	71	71	66	76
HBA 71 M6 0,55kW (A2:6) (30°)	Inlet	48	55	61	68	70	72	72	67	77
HBA 71 M6 0,55kW (A2:6) (28°)	Inlet	48	54	61	68	70	72	73	68	78
HBA 71 M6 0,55kW (A2:6) (25°)	Inlet	47	53	62	69	72	72	74	68	78

**Sound power Lw dB (A)**

Model		63 Hz	125 Hz	250 Hz	500 Hz	1000 Hz	2000 Hz	4000 Hz	8000 Hz	Total
HBA 71 M6 0,55kW (A2:6) (20°)	Inlet	45	51	62	70	73	72	75	68	79
HBA 71 M6 0,55kW (A2:9) (20°)	Inlet	51	57	66	73	76	75	77	70	82
HBA 71 M6 0,55kW (A2:9) (25°)	Inlet	51	57	64	72	74	74	76	69	81
HBA 71 M6 0,55kW (A2:9) (28°)	Inlet	51	57	63	70	73	73	75	69	80
HBA 71 M6 0,55kW (A2:9) (30°)	Inlet	51	57	63	70	72	73	74	69	79
HBA 71 T6 0,55kW (A2:6) (37°)	Inlet	49	56	61	66	69	71	71	65	76
HBA 71 T6 0,55kW (A2:6) (35°)	Inlet	47	54	59	66	68	70	71	64	75
HBA 71 T6 0,55kW (A2:6) (33°)	Inlet	48	55	60	67	69	71	71	66	76
HBA 71 T6 0,55kW (A2:6) (30°)	Inlet	48	55	61	68	70	72	72	67	77
HBA 71 T6 0,55kW (A2:6) (28°)	Inlet	48	54	61	68	70	72	73	68	78
HBA 71 T6 0,55kW (A2:6) (25°)	Inlet	47	53	62	69	72	72	74	68	78
HBA 71 T6 0,55kW (A2:6) (20°)	Inlet	45	51	62	70	73	72	75	68	79
HBA 71 T6 0,55kW (A2:9) (20°)	Inlet	51	57	66	73	76	75	77	70	82
HBA 71 T6 0,55kW (A2:9) (25°)	Inlet	51	57	64	72	74	74	76	69	81
HBA 71 T6 0,55kW (A2:9) (28°)	Inlet	51	57	63	70	73	73	75	69	80
HBA 71 T6 0,55kW (A2:9) (30°)	Inlet	51	57	63	70	72	73	74	69	79
HBA 71 T6 0,75kW (A2:6) (45°)	Inlet	52	56	64	68	71	71	71	65	77
HBA 71 T6 0,75kW (A2:6) (43°)	Inlet	51	57	63	67	70	71	71	65	77
HBA 71 T6 0,75kW (A2:6) (40°)	Inlet	50	57	62	67	70	71	71	65	77
HBA 71 T6 0,75kW (A2:9) (37°)	Inlet	51	58	63	69	73	74	74	68	79
HBA 71 T6 0,75kW (A2:9) (35°)	Inlet	50	57	62	70	73	74	74	68	79
HBA 71 T6 0,75kW (A2:9) (33°)	Inlet	50	57	62	70	73	74	74	69	79
HBA 71 T6 0,75kW (A5:6) (40°)	Inlet	59	65	71	73	76	77	78	68	83
HBA 71 T6 0,75kW (A5:6) (37°)	Inlet	56	63	68	70	73	75	76	65	81
HBA 71 T6 0,75kW (A5:6) (35°)	Inlet	54	61	66	67	71	73	74	63	79
HBA 71 T6 1,1kW (A2:9) (45°)	Inlet	51	58	63	69	72	73	73	67	78
HBA 71 T6 1,1kW (A2:9) (43°)	Inlet	52	59	64	69	73	74	74	68	79
HBA 71 T6 1,1kW (A2:9) (40°)	Inlet	52	59	64	69	73	74	74	68	79
HBA 80 T6 0,75kW (A2:6) (35°)	Inlet	52	59	64	69	72	74	74	67	79
HBA 80 T6 0,75kW (A2:6) (33°)	Inlet	51	58	63	69	72	74	75	68	79
HBA 80 T6 0,75kW (A2:6) (30°)	Inlet	50	57	62	69	72	74	75	68	80
HBA 80 T6 0,75kW (A2:6) (28°)	Inlet	50	57	62	69	73	74	75	69	80
HBA 80 T6 0,75kW (A2:6) (25°)	Inlet	48	55	62	70	73	74	75	69	80
HBA 80 T6 0,75kW (A2:6) (20°)	Inlet	45	52	62	70	74	73	75	70	80
HBA 80 T6 0,75kW (A2:9) (30°)	Inlet	54	61	66	74	77	78	79	73	84
HBA 80 T6 0,75kW (A2:9) (28°)	Inlet	54	61	66	75	78	78	79	73	84
HBA 80 T6 0,75kW (A2:9) (25°)	Inlet	52	62	67	77	79	79	80	73	86
HBA 80 T6 0,75kW (A2:9) (20°)	Inlet	50	62	68	80	82	80	82	74	87
HBA 80 T6 0,75kW (A5:6) (30°)	Inlet	55	62	67	74	78	77	81	74	85



**Sound power Lw dB (A)**

Model		63 Hz	125 Hz	250 Hz	500 Hz	1000 Hz	2000 Hz	4000 Hz	8000 Hz	Total
HBA 80 T6 1,1kW (A2:6) (43°)	Inlet	52	60	65	69	72	73	73	66	78
HBA 80 T6 1,1kW (A2:6) (40°)	Inlet	52	60	65	69	72	73	72	66	78
HBA 80 T6 1,1kW (A2:6) (37°)	Inlet	53	60	65	69	72	73	73	67	79
HBA 80 T6 1,1kW (A2:9) (35°)	Inlet	53	60	65	72	76	77	77	71	82
HBA 80 T6 1,1kW (A2:9) (33°)	Inlet	54	61	66	73	77	78	78	72	83
HBA 80 T6 1,1kW (A5:6) (33°)	Inlet	54	61	66	72	76	75	79	71	83
HBA 80 T6 1,1kW (A5:6) (35°)	Inlet	53	60	65	70	73	74	77	67	81
HBA 80 T6 1,5kW (A2:6) (45°)	Inlet	53	60	66	70	73	73	73	66	79
HBA 80 T6 1,5kW (A2:9) (43°)	Inlet	55	62	67	71	75	76	76	69	81
HBA 80 T6 1,5kW (A2:9) (40°)	Inlet	55	62	67	71	75	77	76	70	82
HBA 80 T6 1,5kW (A2:9) (37°)	Inlet	54	61	66	72	75	77	76	70	82
HBA 80 T6 1,5kW (A5:6) (37°)	Inlet	55	62	67	71	74	75	77	68	81
HBA 80 T6 1,5kW (A5:6) (40°)	Inlet	57	64	69	73	75	76	77	68	82
HBA 80 T6 2,2kW (A2:9) (45°)	Inlet	54	62	68	71	74	75	75	69	81
HBA 80 T6 2,2kW (A5:6) (43°)	Inlet	58	65	70	74	76	76	77	68	82
HBA 90 T6 1,5kW (A6:3) (32°)	Inlet	56	62	69	76	77	78	79	73	84
HBA 90 T6 1,5kW (A6:3) (30°)	Inlet	56	61	68	75	76	77	79	73	83
HBA 90 T6 1,5kW (A6:3) (28°)	Inlet	55	60	67	73	75	76	78	72	82
HBA 90 T6 1,5kW (A6:3) (26°)	Inlet	54	59	66	71	74	75	77	71	81
HBA 90 T6 1,5kW (A6:3) (24°)	Inlet	53	57	65	69	73	74	76	70	80
HBA 90 T6 1,5kW (A6:3) (22°)	Inlet	52	56	64	67	71	72	75	69	79
HBA 90 T6 1,5kW (A6:3) (20°)	Inlet	50	54	62	65	70	71	74	68	78
HBA 90 T6 1,5kW (A6:6) (24°)	Inlet	57	67	73	80	83	82	83	78	88
HBA 90 T6 1,5kW (A6:6) (22°)	Inlet	56	66	72	79	83	81	82	77	88
HBA 90 T6 1,5kW (A6:6) (20°)	Inlet	55	65	71	79	83	81	81	77	88
HBA 90 T6 2,2kW (A6:3) (38°)	Inlet	57	64	71	79	79	80	81	75	87
HBA 90 T6 2,2kW (A6:3) (36°)	Inlet	56	63	70	78	78	79	80	74	85
HBA 90 T6 2,2kW (A6:3) (34°)	Inlet	56	62	69	77	77	78	79	74	85
HBA 90 T6 2,2kW (A6:6) (30°)	Inlet	59	68	74	81	82	82	84	79	89
HBA 90 T6 2,2kW (A6:6) (28°)	Inlet	59	68	73	81	83	82	84	79	89
HBA 90 T6 2,2kW (A6:6) (26°)	Inlet	58	67	73	80	83	82	83	78	89
HBA 90 T6 3kW (A6:3) (40°)	Inlet	57	65	72	80	80	82	82	76	87
HBA 90 T6 3kW (A6:6) (36°)	Inlet	57	65	70	77	78	79	81	75	86
HBA 90 T6 3kW (A6:6) (34°)	Inlet	57	66	71	77	79	80	81	76	86
HBA 90 T6 3kW (A6:6) (32°)	Inlet	58	67	72	79	80	81	83	77	88
HBA 90 T6 4kW (A6:6) (40°)	Inlet	58	67	72	78	79	80	82	76	87
HBA 90 T6 4kW (A6:6) (38°)	Inlet	57	66	71	78	79	80	81	76	86
HBA 100 T6 1,5kW (A6:3) (26°)	Inlet	56	63	68	74	77	79	81	75	85
HBA 100 T6 1,5kW (A6:3) (24°)	Inlet	56	63	68	74	78	79	82	75	86

**Sound power Lw dB (A)**

Model		63 Hz	125 Hz	250 Hz	500 Hz	1000 Hz	2000 Hz	4000 Hz	8000 Hz	Total
HBA 100 T6 1,5kW (A6:3) (22°)	Inlet	56	63	68	73	78	79	83	75	86
HBA 100 T6 1,5kW (A6:3) (20°)	Inlet	55	62	67	72	77	79	82	75	85
HBA 100 T6 2,2kW (A6:3) (26°)	Inlet	56	63	68	74	77	79	81	75	85
HBA 100 T6 2,2kW (A6:3) (24°)	Inlet	56	63	68	74	78	79	82	75	86
HBA 100 T6 2,2kW (A6:3) (22°)	Inlet	56	63	68	73	78	79	83	75	86
HBA 100 T6 2,2kW (A6:3) (20°)	Inlet	55	62	67	72	77	79	82	75	85
HBA 100 T6 2,2kW (A6:3) (32°)	Inlet	58	64	70	76	78	79	80	75	85
HBA 100 T6 2,2kW (A6:3) (30°)	Inlet	56	63	68	74	77	78	80	74	84
HBA 100 T6 2,2kW (A6:3) (28°)	Inlet	56	63	68	74	77	78	80	74	84
HBA 100 T6 2,2kW (A6:6) (24°)	Inlet	60	70	76	85	86	85	86	81	92
HBA 100 T6 2,2kW (A6:6) (22°)	Inlet	60	70	75	85	86	85	86	81	92
HBA 100 T6 2,2kW (A6:6) (20°)	Inlet	59	70	75	86	87	86	86	82	93
HBA 100 T6 3kW (A6:3) (36°)	Inlet	60	66	73	79	80	81	81	76	87
HBA 100 T6 3kW (A6:3) (34°)	Inlet	60	65	72	78	79	80	81	76	86
HBA 100 T6 3kW (A6:6) (28°)	Inlet	63	72	78	85	86	86	87	82	93
HBA 100 T6 3kW (A6:6) (26°)	Inlet	62	71	77	85	86	86	86	82	92
HBA 100 T6 4kW (A6:3) (40°)	Inlet	60	67	73	80	82	82	82	78	88
HBA 100 T6 4kW (A6:3) (38°)	Inlet	60	67	73	79	81	82	82	77	88
HBA 100 T6 4kW (A6:6) (32°)	Inlet	63	71	77	83	84	85	86	81	91
HBA 100 T6 4kW (A6:6) (30°)	Inlet	64	72	78	85	86	86	87	82	93
HBA 100 T6 5,5kW (A6:6) (38°)	Inlet	63	71	76	81	83	84	85	79	90
HBA 100 T6 5,5kW (A6:6) (36°)	Inlet	62	70	76	80	82	83	84	79	89
HBA 100 T6 5,5kW (A6:6) (34°)	Inlet	62	70	76	81	83	83	85	80	90
HBA 100 T6 7,5kW (A6:6) (40°)	Inlet	63	71	77	82	84	85	85	80	91
HBA 112 T6 2,2kW (A6:3) (26°)	Inlet	61	68	73	79	83	84	86	81	90
HBA 112 T6 2,2kW (A6:3) (24°)	Inlet	60	67	72	79	83	84	86	81	90
HBA 112 T6 2,2kW (A6:3) (22°)	Inlet	59	66	71	78	82	83	85	80	90
HBA 112 T6 2,2kW (A6:3) (20°)	Inlet	58	65	70	77	82	83	85	80	89
HBA 112 T6 2,2kW (A6:6) (20°)	Inlet	60	71	76	88	89	87	89	84	95
HBA 112 T6 3kW (A6:3) (32°)	Inlet	63	68	75	80	82	83	85	80	90
HBA 112 T6 3kW (A6:3) (30°)	Inlet	62	67	74	80	82	83	85	80	90
HBA 112 T6 3kW (A6:3) (28°)	Inlet	62	68	74	80	83	83	86	81	90
HBA 112 T6 3kW (A6:6) (24°)	Inlet	61	71	76	86	87	87	88	82	94
HBA 112 T6 3kW (A6:6) (22°)	Inlet	61	71	77	87	88	87	88	83	94
HBA 112 T6 4kW (A6:3) (36°)	Inlet	63	68	75	81	83	83	85	80	90
HBA 112 T6 4kW (A6:3) (34°)	Inlet	63	68	75	80	83	83	85	80	90
HBA 112 T6 4kW (A6:6) (28°)	Inlet	64	72	77	86	87	88	89	82	94
HBA 112 T6 4kW (A6:6) (26°)	Inlet	63	72	77	86	87	87	88	82	94
HBA 112 T6 5,5kW (A6:3) (40°)	Inlet	63	69	75	82	84	84	85	80	91



Sound power Lw dB (A)										
Model		63 Hz	125 Hz	250 Hz	500 Hz	1000 Hz	2000 Hz	4000 Hz	8000 Hz	Total
HBA 112 T6 5,5kW (A6:3) (38°)	Inlet	64	69	76	81	83	84	85	81	90
HBA 112 T6 5,5kW (A6:6) (32°)	Inlet	65	72	77	83	85	87	88	81	92
HBA 112 T6 5,5kW (A6:6) (30°)	Inlet	65	72	77	85	87	88	88	82	93
HBA 112 T6 7,5kW (A6:6) (38°)	Inlet	67	74	79	83	86	87	88	81	93
HBA 112 T6 7,5kW (A6:6) (36°)	Inlet	65	72	77	81	85	86	87	80	92
HBA 112 T6 7,5kW (A6:6) (34°)	Inlet	65	72	77	81	84	86	87	80	92
HBA 112 T6 11kW (A6:6) (40°)	Inlet	69	75	81	85	88	89	89	83	94
HBA 125 T6 3kW (A7:4) (22°)	Inlet	65	77	82	89	92	93	95	91	99
HBA 125 T6 3kW (A7:4) (20°)	Inlet	62	76	81	88	92	92	94	91	99
HBA 125 T6 4kW (A7:4) (26°)	Inlet	66	74	79	85	88	90	91	86	96
HBA 125 T6 4kW (A7:4) (24°)	Inlet	66	75	80	87	90	91	93	89	97
HBA 125 T6 5,5kW (A7:4) (30°)	Inlet	64	71	76	81	85	86	87	81	92
HBA 125 T6 5,5kW (A7:4) (28°)	Inlet	66	73	78	83	87	88	89	84	94
HBA 125 T6 5,5kW (A7:8) (22°)	Inlet	68	76	82	90	96	99	99	93	104
HBA 125 T6 5,5kW (A7:8) (20°)	Inlet	68	76	82	91	98	101	99	94	105
HBA 125 T6 7,5kW (A7:4) (36°)	Inlet	64	71	76	81	84	86	86	79	91
HBA 125 T6 7,5kW (A7:4) (34°)	Inlet	64	71	76	80	84	85	86	79	91
HBA 125 T6 7,5kW (A7:4) (32°)	Inlet	64	71	76	81	84	86	87	80	91
HBA 125 T6 7,5kW (A7:8) (26°)	Inlet	68	74	81	88	94	96	96	90	101
HBA 125 T6 7,5kW (A7:8) (24°)	Inlet	68	75	81	89	95	97	97	91	103
HBA 125 T6 11kW (A7:4) (40°)	Inlet	66	73	78	82	85	87	87	80	92
HBA 125 T6 11kW (A7:4) (38°)	Inlet	65	72	77	82	85	87	87	80	92
HBA 125 T6 11kW (A7:8) (34°)	Inlet	68	74	80	85	88	90	90	83	95
HBA 125 T6 11kW (A7:8) (32°)	Inlet	68	73	80	85	89	92	92	85	97
HBA 125 T6 11kW (A7:8) (30°)	Inlet	67	73	80	85	91	93	93	87	98
HBA 125 T6 11kW (A7:8) (28°)	Inlet	68	74	80	87	92	95	95	89	100
HBA 125 T6 15kW (A7:8) (40°)	Inlet	68	75	80	84	87	89	88	82	94
HBA 125 T6 15kW (A7:8) (38°)	Inlet	68	75	80	85	88	90	89	82	95
HBA 125 T6 15kW (A7:8) (36°)	Inlet	68	75	80	85	88	90	89	82	95

## Hałas / 4/8 poles

Sound power Lw dB (A)										
Model		63 Hz	125 Hz	250 Hz	500 Hz	1000 Hz	2000 Hz	4000 Hz	8000 Hz	Total
HBA 45 T4/T8 0,33/0,04kW (A0:6) (1420 RPM - 40°)	Inlet	39	57	69	74	76	70	63	58	79
HBA 50 T4/T8 0,55/0,09kW (A0:6) (1420 RPM - 40°)	Inlet	51	59	64	68	71	72	72	65	78
HBA 56 T4/T8 0,33/0,04kW (A5:6) (720 RPM - 20°)	Inlet	37	45	52	59	65	60	62	54	68

**Sound power Lw dB (A)**

Model		63 Hz	125 Hz	250 Hz	500 Hz	1000 Hz	2000 Hz	4000 Hz	8000 Hz	Total
HBA 56 T4/T8 0,33/0,04kW (A5:6) (1420 RPM - 20°)	Inlet	52	60	67	74	80	75	77	69	84
HBA 56 T4/T8 0,55/0,09kW (A2:6) (720 RPM - 25°)	Inlet	34	42	50	57	59	60	61	56	66
HBA 56 T4/T8 0,55/0,09kW (A2:6) (720 RPM - 20°)	Inlet	30	38	48	57	59	59	60	56	66
HBA 56 T4/T8 0,55/0,09kW (A2:6) (1420 RPM - 25°)	Inlet	50	57	65	73	75	76	77	72	82
HBA 56 T4/T8 0,55/0,09kW (A2:6) (1420 RPM - 20°)	Inlet	46	54	64	73	75	75	76	72	82
HBA 56 T4/T8 0,55/0,09kW (A2:9) (720 RPM - 20°)	Inlet	38	42	51	58	60	60	61	53	66
HBA 56 T4/T8 0,55/0,09kW (A2:9) (1420 RPM - 20°)	Inlet	54	58	67	73	76	76	77	69	82
HBA 56 T4/T8 0,55/0,09kW (A5:6) (720 RPM - 25°)	Inlet	39	47	52	60	64	61	63	55	69
HBA 56 T4/T8 0,55/0,09kW (A5:6) (1420 RPM - 25°)	Inlet	54	62	67	75	79	76	78	70	84
HBA 56 T4/T8 0,75/0,12kW (A2:6) (720 RPM - 33°)	Inlet	37	44	49	55	57	59	60	54	64
HBA 56 T4/T8 0,75/0,12kW (A2:6) (720 RPM - 30°)	Inlet	36	43	49	55	57	58	60	54	64
HBA 56 T4/T8 0,75/0,12kW (A2:6) (720 RPM - 28°)	Inlet	35	42	49	56	58	59	60	55	65
HBA 56 T4/T8 0,75/0,12kW (A2:6) (1420 RPM - 28°)	Inlet	51	58	65	72	74	75	76	70	81
HBA 56 T4/T8 0,75/0,12kW (A2:6) (1420 RPM - 33°)	Inlet	53	60	65	71	73	75	75	70	80
HBA 56 T4/T8 0,75/0,12kW (A2:6) (1420 RPM - 30°)	Inlet	52	59	65	71	73	74	76	70	80
HBA 56 T4/T8 0,75/0,12kW (A2:9) (720 RPM - 25°)	Inlet	37	42	51	57	60	60	61	55	66
HBA 56 T4/T8 0,75/0,12kW (A2:9) (1420 RPM - 25°)	Inlet	53	58	67	73	76	76	77	71	82
HBA 56 T4/T8 0,75/0,12kW (A5:6) (720 RPM - 33°)	Inlet	39	46	51	60	60	61	64	55	68
HBA 56 T4/T8 0,75/0,12kW (A5:6) (720 RPM - 30°)	Inlet	41	48	53	62	63	62	65	57	69
HBA 56 T4/T8 0,75/0,12kW (A5:6) (1420 RPM - 30°)	Inlet	54	61	66	75	75	76	79	70	83
HBA 56 T4/T8 0,75/0,12kW (A5:6) (1420 RPM - 33°)	Inlet	56	63	68	77	78	78	80	72	85
HBA 56 T4/T8 1,1/0,18kW (A2:6) (720 RPM - 43°)	Inlet	39	45	51	56	58	60	60	54	65
HBA 56 T4/T8 1,1/0,18kW (A2:6) (720 RPM - 40°)	Inlet	38	45	50	56	58	60	60	54	65

**Sound power Lw dB (A)**

Model		63 Hz	125 Hz	250 Hz	500 Hz	1000 Hz	2000 Hz	4000 Hz	8000 Hz	Total
HBA 56 T4/T8 1,1/0,18kW (A2:6) (720 RPM - 37°)	Inlet	37	44	49	55	57	59	60	54	65
HBA 56 T4/T8 1,1/0,18kW (A2:6) (720 RPM - 35°)	Inlet	36	43	48	55	57	59	60	54	64
HBA 56 T4/T8 1,1/0,18kW (A2:6) (1420 RPM - 43°)	Inlet	55	61	67	72	74	76	76	70	81
HBA 56 T4/T8 1,1/0,18kW (A2:6) (1420 RPM - 40°)	Inlet	54	61	66	71	74	75	76	70	81
HBA 56 T4/T8 1,1/0,18kW (A2:6) (1420 RPM - 37°)	Inlet	53	60	65	71	73	75	76	70	81
HBA 56 T4/T8 1,1/0,18kW (A2:6) (1420 RPM - 35°)	Inlet	52	59	64	71	73	75	75	70	80
HBA 56 T4/T8 1,1/0,18kW (A2:9) (720 RPM - 35°)	Inlet	37	43	52	57	60	61	63	57	67
HBA 56 T4/T8 1,1/0,18kW (A2:9) (720 RPM - 33°)	Inlet	37	43	52	57	61	61	63	57	67
HBA 56 T4/T8 1,1/0,18kW (A2:9) (720 RPM - 30°)	Inlet	38	43	51	57	61	61	62	57	67
HBA 56 T4/T8 1,1/0,18kW (A2:9) (720 RPM - 28°)	Inlet	38	43	51	57	61	61	62	56	67
HBA 56 T4/T8 1,1/0,18kW (A2:9) (1420 RPM - 28°)	Inlet	54	59	67	73	76	77	78	72	83
HBA 56 T4/T8 1,1/0,18kW (A2:9) (1420 RPM - 35°)	Inlet	53	59	68	73	76	77	79	73	83
HBA 56 T4/T8 1,1/0,18kW (A2:9) (1420 RPM - 33°)	Inlet	53	59	68	73	76	77	78	73	83
HBA 56 T4/T8 1,1/0,18kW (A2:9) (1420 RPM - 30°)	Inlet	54	59	67	73	77	77	78	73	83
HBA 56 T4/T8 1,1/0,18kW (A5:6) (720 RPM - 37°)	Inlet	39	46	51	59	59	60	63	54	67
HBA 56 T4/T8 1,1/0,18kW (A5:6) (720 RPM - 35°)	Inlet	38	45	50	58	58	60	62	54	66
HBA 56 T4/T8 1,1/0,18kW (A5:6) (1420 RPM - 37°)	Inlet	54	61	66	75	74	76	78	69	82
HBA 56 T4/T8 1,1/0,18kW (A5:6) (1420 RPM - 35°)	Inlet	53	60	65	74	73	75	78	69	82
HBA 56 T4/T8 1,5/0,25kW (A2:6) (720 RPM - 45°)	Inlet	40	44	52	56	59	61	60	55	66
HBA 56 T4/T8 1,5/0,25kW (A2:6) (1420 RPM - 45°)	Inlet	56	60	68	72	75	77	76	71	82
HBA 56 T4/T8 1,5/0,25kW (A2:9) (720 RPM - 43°)	Inlet	37	44	53	57	60	61	62	56	67
HBA 56 T4/T8 1,5/0,25kW (A2:9) (720 RPM - 40°)	Inlet	37	44	53	57	60	61	62	56	67
HBA 56 T4/T8 1,5/0,25kW (A2:9) (720 RPM - 37°)	Inlet	37	43	52	57	60	61	62	57	67

**Sound power Lw dB (A)**

Model		63 Hz	125 Hz	250 Hz	500 Hz	1000 Hz	2000 Hz	4000 Hz	8000 Hz	Total
HBA 56 T4/T8 1,5/0,25kW (A2:9) (1420 RPM - 37°)	Inlet	53	59	68	73	76	77	78	73	83
HBA 56 T4/T8 1,5/0,25kW (A2:9) (1420 RPM - 43°)	Inlet	53	60	69	73	76	77	78	72	83
HBA 56 T4/T8 1,5/0,25kW (A2:9) (1420 RPM - 40°)	Inlet	53	60	69	73	76	77	78	72	83
HBA 56 T4/T8 1,5/0,25kW (A5:6) (720 RPM - 40°)	Inlet	41	48	53	60	60	61	63	55	68
HBA 56 T4/T8 1,5/0,25kW (A5:6) (1420 RPM - 40°)	Inlet	56	63	68	76	75	76	79	70	83
HBA 63 T4/T8 0,55/0,09kW (A2:6) (720 RPM - 20°)	Inlet	33	36	48	58	58	57	59	54	64
HBA 63 T4/T8 0,55/0,09kW (A2:6) (1420 RPM - 20°)	Inlet	49	51	64	74	73	73	75	70	80
HBA 63 T4/T8 0,75/0,12kW (A2:6) (720 RPM - 25°)	Inlet	37	42	51	59	60	61	62	57	67
HBA 63 T4/T8 0,75/0,12kW (A2:6) (1420 RPM - 25°)	Inlet	53	58	67	75	76	77	78	73	83
HBA 63 T4/T8 0,75/0,12kW (A2:9) (720 RPM - 20°)	Inlet	41	44	55	61	63	62	63	58	69
HBA 63 T4/T8 0,75/0,12kW (A2:9) (1420 RPM - 20°)	Inlet	57	60	71	77	78	77	79	74	85
HBA 63 T4/T8 0,75/0,12kW (A5:6) (720 RPM - 25°)	Inlet	42	51	56	65	65	64	65	60	71
HBA 63 T4/T8 0,75/0,12kW (A5:6) (1420 RPM - 25°)	Inlet	57	66	71	80	80	79	80	75	86
HBA 63 T4/T8 1,1/0,18kW (A2:6) (720 RPM - 33°)	Inlet	37	45	50	57	59	61	62	56	67
HBA 63 T4/T8 1,1/0,18kW (A2:6) (720 RPM - 30°)	Inlet	37	44	51	58	60	61	62	57	67
HBA 63 T4/T8 1,1/0,18kW (A2:6) (720 RPM - 28°)	Inlet	37	43	51	58	60	61	62	57	67
HBA 63 T4/T8 1,1/0,18kW (A2:6) (1420 RPM - 28°)	Inlet	53	59	67	74	76	77	78	73	83
HBA 63 T4/T8 1,1/0,18kW (A2:6) (1420 RPM - 33°)	Inlet	53	61	66	73	75	77	77	72	82
HBA 63 T4/T8 1,1/0,18kW (A2:6) (1420 RPM - 30°)	Inlet	53	60	66	74	75	77	78	73	83
HBA 63 T4/T8 1,1/0,18kW (A2:9) (720 RPM - 28°)	Inlet	42	46	54	60	62	63	65	59	69
HBA 63 T4/T8 1,1/0,18kW (A2:9) (720 RPM - 25°)	Inlet	41	45	54	60	62	62	64	58	69
HBA 63 T4/T8 1,1/0,18kW (A2:9) (1420 RPM - 28°)	Inlet	58	62	70	76	78	79	80	75	85
HBA 63 T4/T8 1,1/0,18kW (A2:9) (1420 RPM - 25°)	Inlet	57	61	70	76	78	78	80	74	85

**Sound power Lw dB (A)**

Model		63 Hz	125 Hz	250 Hz	500 Hz	1000 Hz	2000 Hz	4000 Hz	8000 Hz	Total
HBA 63 T4/T8 1,1/0,18kW (A5:6) (720 RPM - 30°)	Inlet	45	53	59	65	65	64	67	62	72
HBA 63 T4/T8 1,1/0,18kW (A5:6) (1420 RPM - 30°)	Inlet	60	68	74	80	80	79	82	77	87
HBA 63 T4/T8 1,5/0,25kW (A2:6) (720 RPM - 40°)	Inlet	40	46	52	58	60	62	62	56	67
HBA 63 T4/T8 1,5/0,25kW (A2:6) (720 RPM - 37°)	Inlet	38	45	50	57	59	61	61	56	67
HBA 63 T4/T8 1,5/0,25kW (A2:6) (720 RPM - 35°)	Inlet	37	44	49	56	58	61	61	56	66
HBA 63 T4/T8 1,5/0,25kW (A2:6) (1420 RPM - 35°)	Inlet	53	60	65	72	74	77	77	72	82
HBA 63 T4/T8 1,5/0,25kW (A2:6) (1420 RPM - 40°)	Inlet	55	62	67	73	76	77	77	72	83
HBA 63 T4/T8 1,5/0,25kW (A2:6) (1420 RPM - 37°)	Inlet	54	61	66	73	75	77	77	72	82
HBA 63 T4/T8 1,5/0,25kW (A2:9) (720 RPM - 33°)	Inlet	41	47	54	61	63	64	65	60	70
HBA 63 T4/T8 1,5/0,25kW (A2:9) (720 RPM - 30°)	Inlet	42	47	54	61	62	64	65	60	70
HBA 63 T4/T8 1,5/0,25kW (A2:9) (1420 RPM - 33°)	Inlet	57	63	70	77	79	80	81	75	86
HBA 63 T4/T8 1,5/0,25kW (A2:9) (1420 RPM - 30°)	Inlet	58	63	70	76	78	80	81	75	86
HBA 63 T4/T8 1,5/0,25kW (A5:6) (720 RPM - 35°)	Inlet	59	67	72	75	76	76	79	73	83
HBA 63 T4/T8 1,5/0,25kW (A5:6) (720 RPM - 33°)	Inlet	44	52	58	62	63	62	65	60	70
HBA 63 T4/T8 1,5/0,25kW (A5:6) (1420 RPM - 35°)	Inlet	59	67	72	75	76	76	79	73	83
HBA 63 T4/T8 1,5/0,25kW (A5:6) (1420 RPM - 33°)	Inlet	59	68	73	77	78	77	80	75	85
HBA 63 T4/T8 2,2/0,37kW (A2:6) (720 RPM - 45°)	Inlet	42	46	54	59	62	62	62	56	68
HBA 63 T4/T8 2,2/0,37kW (A2:6) (720 RPM - 43°)	Inlet	40	46	52	58	60	62	62	56	67
HBA 63 T4/T8 2,2/0,37kW (A2:6) (1420 RPM - 43°)	Inlet	56	62	68	74	76	78	78	72	83
HBA 63 T4/T8 2,2/0,37kW (A2:6) (1420 RPM - 45°)	Inlet	58	62	70	74	78	78	78	72	84
HBA 63 T4/T8 2,2/0,37kW (A2:9) (720 RPM - 43°)	Inlet	41	48	53	60	63	64	65	60	70
HBA 63 T4/T8 2,2/0,37kW (A2:9) (720 RPM - 40°)	Inlet	41	48	53	60	63	64	65	60	70
HBA 63 T4/T8 2,2/0,37kW (A2:9) (720 RPM - 37°)	Inlet	41	47	54	60	63	64	65	60	70

**Sound power Lw dB (A)**

Model		63 Hz	125 Hz	250 Hz	500 Hz	1000 Hz	2000 Hz	4000 Hz	8000 Hz	Total
HBA 63 T4/T8 2,2/0,37kW (A2:9) (720 RPM - 35°)	Inlet	41	47	54	61	63	64	65	60	70
HBA 63 T4/T8 2,2/0,37kW (A2:9) (1420 RPM - 43°)	Inlet	57	64	69	76	79	80	81	76	86
HBA 63 T4/T8 2,2/0,37kW (A2:9) (1420 RPM - 40°)	Inlet	57	63	69	76	79	80	80	76	86
HBA 63 T4/T8 2,2/0,37kW (A2:9) (1420 RPM - 37°)	Inlet	57	63	70	76	79	80	81	76	86
HBA 63 T4/T8 2,2/0,37kW (A2:9) (1420 RPM - 35°)	Inlet	57	63	70	77	79	80	81	76	86
HBA 63 T4/T8 2,2/0,37kW (A5:6) (720 RPM - 37°)	Inlet	44	52	57	61	62	62	64	58	69
HBA 63 T4/T8 2,2/0,37kW (A5:6) (720 RPM - 40°)	Inlet	45	52	57	62	62	63	65	58	70
HBA 63 T4/T8 2,2/0,37kW (A5:6) (1420 RPM - 37°)	Inlet	59	67	72	76	77	77	79	73	84
HBA 63 T4/T8 2,2/0,37kW (A5:6) (1420 RPM - 40°)	Inlet	60	67	72	77	78	78	80	73	85
HBA 63 T4/T8 3/0,55kW (A2:9) (720 RPM - 45°)	Inlet	41	48	53	60	63	64	65	59	70
HBA 63 T4/T8 3/0,55kW (A2:9) (1420 RPM - 45°)	Inlet	57	64	69	76	78	80	81	75	86
HBA 71 T4/T8 0,75/0,12kW (A2:6) (1420 RPM - 20°)	Inlet	55	61	72	79	83	82	84	78	89
HBA 71 T4/T8 0,75/0,12kW (A5:6) (720 RPM - 20°)	Inlet	40	51	56	71	70	67	69	61	76
HBA 71 T4/T8 0,75/0,12kW (A5:6) (1420 RPM - 20°)	Inlet	55	66	71	86	85	82	84	76	91
HBA 71 T4/T8 1,1/0,18kW (A2:6) (1420 RPM - 25°)	Inlet	57	63	71	79	81	82	83	77	88
HBA 71 T4/T8 1,1/0,18kW (A2:9) (720 RPM - 20°)	Inlet	44	51	60	67	69	69	71	64	76
HBA 71 T4/T8 1,1/0,18kW (A2:9) (1420 RPM - 20°)	Inlet	60	66	75	83	85	85	87	79	91
HBA 71 T4/T8 1,1/0,18kW (A5:6) (720 RPM - 25°)	Inlet	44	51	56	69	68	67	69	60	75
HBA 71 T4/T8 1,1/0,18kW (A5:6) (1420 RPM - 25°)	Inlet	59	67	72	84	84	82	84	75	90
HBA 71 T4/T8 1,5/0,25kW (A2:6) (1420 RPM - 28°)	Inlet	57	64	70	78	80	81	82	77	87
HBA 71 T4/T8 1,5/0,25kW (A2:6) (720 RPM - 28°)	Inlet	42	48	54	62	64	65	66	61	71
HBA 71 T4/T8 1,5/0,25kW (A2:6) (1420 RPM - 33°)	Inlet	57	64	69	76	78	80	81	75	86
HBA 71 T4/T8 1,5/0,25kW (A2:6) (1420 RPM - 30°)	Inlet	58	64	70	78	79	81	82	77	87

**Sound power Lw dB (A)**

Model		63 Hz	125 Hz	250 Hz	500 Hz	1000 Hz	2000 Hz	4000 Hz	8000 Hz	Total
HBA 71 T4/T8 1,5/0,25kW (A2:6) (720 RPM - 33°)	Inlet	41	48	53	60	62	64	65	59	70
HBA 71 T4/T8 1,5/0,25kW (A2:6) (720 RPM - 30°)	Inlet	42	48	54	62	63	65	66	61	71
HBA 71 T4/T8 1,5/0,25kW (A2:9) (1420 RPM - 25°)	Inlet	60	67	74	81	83	84	85	79	90
HBA 71 T4/T8 1,5/0,25kW (A2:9) (720 RPM - 25°)	Inlet	44	51	58	65	68	68	69	63	74
HBA 71 T4/T8 1,5/0,25kW (A5:6) (720 RPM - 30°)	Inlet	46	53	58	67	67	68	69	58	74
HBA 71 T4/T8 1,5/0,25kW (A5:6) (1420 RPM - 30°)	Inlet	61	68	73	82	82	83	84	73	89
HBA 71 T4/T8 2,2/0,37kW (A2:6) (720 RPM - 40°)	Inlet	43	50	55	61	64	65	64	58	70
HBA 71 T4/T8 2,2/0,37kW (A2:6) (720 RPM - 37°)	Inlet	42	49	54	60	63	64	64	58	70
HBA 71 T4/T8 2,2/0,37kW (A2:6) (720 RPM - 35°)	Inlet	41	48	53	59	61	64	64	58	69
HBA 71 T4/T8 2,2/0,37kW (A2:6) (1420 RPM - 40°)	Inlet	59	66	71	77	80	81	80	74	86
HBA 71 T4/T8 2,2/0,37kW (A2:6) (1420 RPM - 37°)	Inlet	58	65	70	76	78	80	80	74	85
HBA 71 T4/T8 2,2/0,37kW (A2:6) (1420 RPM - 35°)	Inlet	57	64	69	75	77	79	80	74	85
HBA 71 T4/T8 2,2/0,37kW (A2:9) (720 RPM - 33°)	Inlet	44	51	56	63	66	67	68	62	73
HBA 71 T4/T8 2,2/0,37kW (A2:9) (720 RPM - 30°)	Inlet	44	51	56	63	66	67	68	62	73
HBA 71 T4/T8 2,2/0,37kW (A2:9) (720 RPM - 28°)	Inlet	44	51	57	64	66	67	68	63	73
HBA 71 T4/T8 2,2/0,37kW (A2:9) (1420 RPM - 33°)	Inlet	60	67	72	79	82	83	83	78	89
HBA 71 T4/T8 2,2/0,37kW (A2:9) (1420 RPM - 30°)	Inlet	60	67	72	79	82	83	84	78	89
HBA 71 T4/T8 2,2/0,37kW (A2:9) (1420 RPM - 28°)	Inlet	60	67	73	80	82	83	84	78	89
HBA 71 T4/T8 2,2/0,37kW (A5:6) (720 RPM - 35°)	Inlet	47	54	59	61	65	67	68	57	72
HBA 71 T4/T8 2,2/0,37kW (A5:6) (720 RPM - 33°)	Inlet	46	53	58	64	66	68	68	58	73
HBA 71 T4/T8 2,2/0,37kW (A5:6) (1420 RPM - 35°)	Inlet	62	69	74	76	80	82	83	72	87
HBA 71 T4/T8 2,2/0,37kW (A5:6) (1420 RPM - 33°)	Inlet	62	69	74	79	81	83	84	73	88
HBA 71 T4/T8 3/0,55kW (A2:6) (720 RPM - 45°)	Inlet	46	50	58	61	64	65	65	58	71



**Sound power Lw dB (A)**

Model		63 Hz	125 Hz	250 Hz	500 Hz	1000 Hz	2000 Hz	4000 Hz	8000 Hz	Total
HBA 71 T4/T8 3/0,55kW (A2:6) (720 RPM - 43°)	Inlet	44	50	56	61	64	65	64	58	70
HBA 71 T4/T8 3/0,55kW (A2:6) (1420 RPM - 45°)	Inlet	62	66	74	77	80	81	81	74	86
HBA 71 T4/T8 3/0,55kW (A2:6) (1420 RPM - 43°)	Inlet	60	66	72	77	80	81	80	74	86
HBA 71 T4/T8 3/0,55kW (A2:9) (720 RPM - 37°)	Inlet	45	52	57	63	66	68	67	62	73
HBA 71 T4/T8 3/0,55kW (A2:9) (720 RPM - 35°)	Inlet	44	51	56	63	66	68	67	62	73
HBA 71 T4/T8 3/0,55kW (A2:9) (1420 RPM - 37°)	Inlet	61	68	73	79	82	83	83	78	89
HBA 71 T4/T8 3/0,55kW (A2:9) (1420 RPM - 35°)	Inlet	60	67	72	79	82	83	83	78	89
HBA 71 T4/T8 3/0,55kW (A5:6) (720 RPM - 40°)	Inlet	52	58	64	66	69	70	71	61	76
HBA 71 T4/T8 3/0,55kW (A5:6) (720 RPM - 37°)	Inlet	50	56	62	64	67	69	70	59	74
HBA 71 T4/T8 3/0,55kW (A5:6) (1420 RPM - 40°)	Inlet	67	73	79	81	84	85	86	76	91
HBA 71 T4/T8 3/0,55kW (A5:6) (1420 RPM - 37°)	Inlet	65	71	77	79	82	84	85	74	89
HBA 80 T4/T8 1,1/0,18kW (A2:6) (720 RPM - 20°)	Inlet	38	45	55	64	67	67	68	64	73
HBA 80 T4/T8 1,1/0,18kW (A2:6) (1420 RPM - 20°)	Inlet	54	61	71	79	83	83	84	79	89
HBA 80 T4/T8 1,5/0,25kW (A2:6) (720 RPM - 25°)	Inlet	42	49	56	63	67	67	69	63	73
HBA 80 T4/T8 1,5/0,25kW (A2:6) (1420 RPM - 25°)	Inlet	57	64	72	79	83	83	84	79	89
HBA 80 T4/T8 1,5/0,25kW (A2:9) (720 RPM - 20°)	Inlet	44	56	61	73	75	74	76	68	81
HBA 80 T4/T8 1,5/0,25kW (A2:9) (1420 RPM - 20°)	Inlet	60	72	77	89	91	89	92	84	97
HBA 80 T4/T8 2,2/0,37kW (A2:6) (720 RPM - 33°)	Inlet	45	52	57	63	66	68	68	62	73
HBA 80 T4/T8 2,2/0,37kW (A2:6) (720 RPM - 30°)	Inlet	44	51	56	63	66	68	68	62	73
HBA 80 T4/T8 2,2/0,37kW (A2:6) (720 RPM - 28°)	Inlet	44	51	56	63	66	68	68	62	73
HBA 80 T4/T8 2,2/0,37kW (A2:6) (1420 RPM - 33°)	Inlet	61	68	73	79	82	84	84	77	89
HBA 80 T4/T8 2,2/0,37kW (A2:6) (1420 RPM - 30°)	Inlet	60	67	72	79	82	84	84	78	89
HBA 80 T4/T8 2,2/0,37kW (A2:6) (1420 RPM - 28°)	Inlet	60	67	72	79	82	84	84	78	89



**Sound power Lw dB (A)**

Model		63 Hz	125 Hz	250 Hz	500 Hz	1000 Hz	2000 Hz	4000 Hz	8000 Hz	Total
HBA 80 T4/T8 2,2/0,37kW (A2:9) (720 RPM - 25°)	Inlet	46	55	60	71	73	72	74	67	79
HBA 80 T4/T8 2,2/0,37kW (A2:9) (1420 RPM - 25°)	Inlet	62	71	76	86	89	88	90	83	95
HBA 80 T4/T8 3/0,55kW (A2:6) (720 RPM - 35°)	Inlet	46	53	58	63	66	68	68	61	73
HBA 80 T4/T8 3/0,55kW (A2:6) (720 RPM - 37°)	Inlet	46	53	58	62	65	67	67	60	72
HBA 80 T4/T8 3/0,55kW (A2:6) (1420 RPM - 35°)	Inlet	62	69	74	78	81	84	84	77	89
HBA 80 T4/T8 3/0,55kW (A2:6) (1420 RPM - 37°)	Inlet	62	69	74	78	81	83	83	76	88
HBA 80 T4/T8 3/0,55kW (A2:9) (720 RPM - 30°)	Inlet	48	55	60	68	71	72	72	66	77
HBA 80 T4/T8 3/0,55kW (A2:9) (720 RPM - 28°)	Inlet	48	55	60	69	72	72	73	67	78
HBA 80 T4/T8 3/0,55kW (A2:9) (1420 RPM - 30°)	Inlet	63	70	75	84	87	88	88	82	93
HBA 80 T4/T8 3/0,55kW (A2:9) (1420 RPM - 28°)	Inlet	63	71	76	85	88	88	89	82	94
HBA 80 T4/T8 3/0,55kW (A5:6) (720 RPM - 35°)	Inlet	47	54	59	64	67	67	71	61	74
HBA 80 T4/T8 3/0,55kW (A5:6) (1420 RPM - 35°)	Inlet	62	69	74	79	82	82	86	76	89
HBA 80 T4/T8 3/0,55kW (A5:6) (720 RPM - 33°)	Inlet	48	55	60	66	69	69	73	64	76
HBA 80 T4/T8 3/0,55kW (A5:6) (1420 RPM - 33°)	Inlet	63	70	75	81	85	84	88	80	91
HBA 80 T4/T8 3/0,55kW (A5:6) (720 RPM - 30°)	Inlet	49	56	61	68	72	71	74	68	79
HBA 80 T4/T8 3/0,55kW (A5:6) (1420 RPM - 30°)	Inlet	64	71	76	83	87	86	90	83	94
HBA 80 T4/T8 4/0,75kW (A2:6) (720 RPM - 43°)	Inlet	46	53	59	62	65	66	66	59	72
HBA 80 T4/T8 4/0,75kW (A2:6) (720 RPM - 40°)	Inlet	46	53	58	62	65	66	66	59	72
HBA 80 T4/T8 4/0,75kW (A2:6) (1420 RPM - 43°)	Inlet	62	69	75	78	81	82	82	75	88
HBA 80 T4/T8 4/0,75kW (A2:6) (1420 RPM - 40°)	Inlet	61	69	74	78	81	82	82	75	88
HBA 80 T4/T8 4/0,75kW (A2:9) (720 RPM - 33°)	Inlet	47	54	59	67	70	71	71	65	77
HBA 80 T4/T8 4/0,75kW (A2:9) (1420 RPM - 33°)	Inlet	63	70	75	83	86	87	87	81	93
HBA 80 T4/T8 4/0,75kW (A5:6) (720 RPM - 37°)	Inlet	49	56	61	65	68	68	71	61	75

**Sound power Lw dB (A)**

Model		63 Hz	125 Hz	250 Hz	500 Hz	1000 Hz	2000 Hz	4000 Hz	8000 Hz	Total
HBA 80 T4/T8 4/0,75kW (A5:6) (1420 RPM - 37°)	Inlet	64	71	76	80	83	83	86	76	90
HBA 80 T4/T8 4/0,75kW (A5:6) (720 RPM - 40°)	Inlet	51	58	63	67	69	69	70	61	76
HBA 80 T4/T8 4/0,75kW (A5:6) (1420 RPM - 40°)	Inlet	66	73	78	82	84	84	86	76	91
HBA 80 T4/T8 5,5/1,1kW (A2:6) (720 RPM - 45°)	Inlet	46	54	60	63	66	66	66	59	72
HBA 80 T4/T8 5,5/1,1kW (A2:6) (1420 RPM - 45°)	Inlet	62	69	75	79	82	82	82	75	88
HBA 80 T4/T8 5,5/1,1kW (A2:9) (720 RPM - 40°)	Inlet	48	55	60	65	68	70	70	63	75
HBA 80 T4/T8 5,5/1,1kW (A2:9) (720 RPM - 37°)	Inlet	47	54	59	65	69	71	70	64	76
HBA 80 T4/T8 5,5/1,1kW (A2:9) (720 RPM - 35°)	Inlet	47	54	59	65	69	71	70	64	76
HBA 80 T4/T8 5,5/1,1kW (A2:9) (1420 RPM - 40°)	Inlet	64	71	76	81	84	86	85	79	91
HBA 80 T4/T8 5,5/1,1kW (A2:9) (1420 RPM - 37°)	Inlet	63	70	75	81	85	87	86	80	91
HBA 80 T4/T8 5,5/1,1kW (A2:9) (1420 RPM - 35°)	Inlet	62	69	74	81	85	87	86	80	92
HBA 90 T4/T8 3/0,55kW (A6:3) (720 RPM - 22°)	Inlet	45	49	57	61	65	66	69	63	73
HBA 90 T4/T8 3/0,55kW (A6:3) (1420 RPM - 22°)	Inlet	61	65	73	77	81	82	85	79	89
HBA 90 T4/T8 3/0,55kW (A6:3) (1420 RPM - 20°)	Inlet	60	63	72	75	79	80	84	78	87
HBA 90 T4/T8 4/0,75kW (A6:3) (720 RPM - 26°)	Inlet	47	52	60	65	67	68	71	65	75
HBA 90 T4/T8 4/0,75kW (A6:3) (720 RPM - 24°)	Inlet	47	51	59	63	66	67	70	64	74
HBA 90 T4/T8 4/0,75kW (A6:3) (720 RPM - 28°)	Inlet	48	53	61	67	68	69	71	66	76
HBA 90 T4/T8 4/0,75kW (A6:3) (1420 RPM - 26°)	Inlet	63	68	76	81	83	84	87	81	91
HBA 90 T4/T8 4/0,75kW (A6:3) (1420 RPM - 24°)	Inlet	62	67	75	79	82	83	86	80	90
HBA 90 T4/T8 4/0,75kW (A6:3) (1420 RPM - 28°)	Inlet	64	69	77	82	84	85	87	82	92
HBA 90 T4/T8 5,5/1,1kW (A6:3) (720 RPM - 30°)	Inlet	49	55	62	68	70	71	72	66	77
HBA 90 T4/T8 5,5/1,1kW (A6:3) (720 RPM - 32°)	Inlet	49	55	62	70	70	71	73	67	78
HBA 90 T4/T8 5,5/1,1kW (A6:3) (1420 RPM - 30°)	Inlet	65	71	78	84	85	86	88	82	93

**Sound power Lw dB (A)**

Model		63 Hz	125 Hz	250 Hz	500 Hz	1000 Hz	2000 Hz	4000 Hz	8000 Hz	Total
HBA 90 T4/T8 5,5/1,1kW (A6:3) (1420 RPM - 32°)	Inlet	65	71	78	86	86	87	88	83	94
HBA 90 T4/T8 5,5/1,1kW (A6:6) (720 RPM - 22°)	Inlet	50	59	65	73	76	75	75	71	82
HBA 90 T4/T8 5,5/1,1kW (A6:6) (1420 RPM - 22°)	Inlet	66	75	81	89	92	91	91	86	97
HBA 90 T4/T8 5,5/1,1kW (A6:6) (1420 RPM - 20°)	Inlet	65	75	81	88	92	90	91	86	97
HBA 90 T4/T8 7,5/1,5kW (A6:3) (1420 RPM - 36°)	Inlet	66	72	79	88	87	89	89	84	95
HBA 90 T4/T8 7,5/1,5kW (A6:3) (720 RPM - 36°)	Inlet	50	56	63	72	72	73	73	68	79
HBA 90 T4/T8 7,5/1,5kW (A6:3) (1420 RPM - 34°)	Inlet	66	72	79	87	87	88	89	83	94
HBA 90 T4/T8 7,5/1,5kW (A6:3) (720 RPM - 34°)	Inlet	50	56	63	71	71	72	73	67	78
HBA 90 T4/T8 7,5/1,5kW (A6:6) (1420 RPM - 28°)	Inlet	68	77	83	90	92	92	93	88	98
HBA 90 T4/T8 7,5/1,5kW (A6:6) (720 RPM - 28°)	Inlet	52	61	67	74	76	76	77	72	83
HBA 90 T4/T8 7,5/1,5kW (A6:6) (1420 RPM - 26°)	Inlet	67	77	82	90	92	91	92	88	98
HBA 90 T4/T8 7,5/1,5kW (A6:6) (1420 RPM - 24°)	Inlet	67	76	82	89	92	91	92	87	98
HBA 90 T4/T8 7,5/1,5kW (A6:6) (720 RPM - 26°)	Inlet	52	61	67	74	76	76	77	72	82
HBA 90 T4/T8 7,5/1,5kW (A6:6) (720 RPM - 24°)	Inlet	51	60	66	74	76	75	76	71	82
HBA 90 T4/T8 11/3kW (A6:3) (1420 RPM - 40°)	Inlet	66	74	81	89	90	91	91	86	97
HBA 90 T4/T8 11/3kW (A6:3) (1420 RPM - 38°)	Inlet	66	73	80	89	89	90	90	85	96
HBA 90 T4/T8 11/3kW (A6:3) (720 RPM - 40°)	Inlet	50	58	65	74	74	75	75	70	81
HBA 90 T4/T8 11/3kW (A6:3) (720 RPM - 38°)	Inlet	50	58	64	73	73	74	74	69	80
HBA 90 T4/T8 11/3kW (A6:6) (1420 RPM - 34°)	Inlet	66	75	80	87	88	89	91	85	95
HBA 90 T4/T8 11/3kW (A6:6) (1420 RPM - 32°)	Inlet	68	77	82	89	90	90	92	87	97
HBA 90 T4/T8 11/3kW (A6:6) (1420 RPM - 30°)	Inlet	69	78	83	90	92	92	93	89	99
HBA 90 T4/T8 11/3kW (A6:6) (720 RPM - 34°)	Inlet	50	59	64	71	72	73	75	69	80
HBA 90 T4/T8 11/3kW (A6:6) (720 RPM - 32°)	Inlet	52	61	66	73	74	75	76	71	81

**Sound power Lw dB (A)**

Model		63 Hz	125 Hz	250 Hz	500 Hz	1000 Hz	2000 Hz	4000 Hz	8000 Hz	Total
HBA 90 T4/T8 11/3kW (A6:6) (720 RPM - 30°)	Inlet	53	62	67	75	76	76	77	73	83
HBA 90 T4/T8 15/3,5kW (A6:6) (1420 RPM - 40°)	Inlet	68	76	81	88	89	90	91	85	96
HBA 90 T4/T8 15/3,5kW (A6:6) (1420 RPM - 38°)	Inlet	67	76	81	87	88	89	91	85	96
HBA 90 T4/T8 15/3,5kW (A6:6) (1420 RPM - 36°)	Inlet	66	75	80	86	88	89	90	85	95
HBA 90 T4/T8 15/3,5kW (A6:6) (720 RPM - 40°)	Inlet	52	60	65	72	73	74	75	69	80
HBA 90 T4/T8 15/3,5kW (A6:6) (720 RPM - 38°)	Inlet	51	60	65	71	72	73	75	69	80
HBA 90 T4/T8 15/3,5kW (A6:6) (720 RPM - 36°)	Inlet	50	59	64	70	72	73	74	69	79
HBA 100 T4/T8 5,5/1,1kW (A6:3) (1420 RPM - 24°)	Inlet	66	72	78	83	87	88	91	85	95
HBA 100 T4/T8 5,5/1,1kW (A6:3) (720 RPM - 24°)	Inlet	50	56	62	67	71	73	76	69	79
HBA 100 T4/T8 5,5/1,1kW (A6:3) (1420 RPM - 26°)	Inlet	66	72	78	83	87	88	91	84	94
HBA 100 T4/T8 5,5/1,1kW (A6:3) (720 RPM - 26°)	Inlet	50	56	62	67	71	72	75	68	79
HBA 100 T4/T8 5,5/1,1kW (A6:3) (1420 RPM - 20°)	Inlet	64	71	76	81	87	88	92	84	95
HBA 100 T4/T8 5,5/1,1kW (A6:3) (1420 RPM - 22°)	Inlet	64	71	76	81	87	88	92	84	95
HBA 100 T4/T8 7,5/1,5kW (A6:3) (1420 RPM - 30°)	Inlet	66	72	78	84	86	87	89	83	94
HBA 100 T4/T8 7,5/1,5kW (A6:3) (1420 RPM - 28°)	Inlet	66	72	78	83	86	88	90	84	94
HBA 100 T4/T8 7,5/1,5kW (A6:3) (720 RPM - 30°)	Inlet	50	56	62	68	70	71	73	67	78
HBA 100 T4/T8 7,5/1,5kW (A6:3) (720 RPM - 28°)	Inlet	50	56	62	68	71	72	74	68	78
HBA 100 T4/T8 7,5/1,5kW (A6:6) (1420 RPM - 22°)	Inlet	69	80	85	95	95	95	95	91	102
HBA 100 T4/T8 7,5/1,5kW (A6:6) (720 RPM - 22°)	Inlet	53	64	69	79	79	79	79	75	86
HBA 100 T4/T8 7,5/1,5kW (A6:6) (1420 RPM - 20°)	Inlet	69	80	85	95	96	95	95	91	102
HBA 100 T4/T8 11/3kW (A6:3) (1420 RPM - 36°)	Inlet	69	75	82	88	90	90	91	86	96
HBA 100 T4/T8 11/3kW (A6:3) (1420 RPM - 34°)	Inlet	69	75	81	87	89	90	90	85	96
HBA 100 T4/T8 11/3kW (A6:3) (1420 RPM - 32°)	Inlet	68	73	80	85	87	88	90	84	95

		Sound power Lw dB (A)								
Model		63 Hz	125 Hz	250 Hz	500 Hz	1000 Hz	2000 Hz	4000 Hz	8000 Hz	Total
HBA 100 T4/T8 11/3kW (A6:3) (720 RPM - 36°)	Inlet	54	59	66	72	74	74	75	70	81
HBA 100 T4/T8 11/3kW (A6:3) (720 RPM - 34°)	Inlet	53	59	65	71	73	74	74	69	80
HBA 100 T4/T8 11/3kW (A6:3) (720 RPM - 32°)	Inlet	52	57	64	70	72	73	74	68	79
HBA 100 T4/T8 11/3kW (A6:6) (1420 RPM - 28°)	Inlet	73	81	87	95	95	95	96	92	103
HBA 100 T4/T8 11/3kW (A6:6) (1420 RPM - 26°)	Inlet	71	81	86	94	95	95	96	91	102
HBA 100 T4/T8 11/3kW (A6:6) (1420 RPM - 24°)	Inlet	70	80	85	94	95	95	95	91	102
HBA 100 T4/T8 11/3kW (A6:6) (720 RPM - 28°)	Inlet	57	65	71	79	79	80	81	76	87
HBA 100 T4/T8 11/3kW (A6:6) (720 RPM - 26°)	Inlet	55	65	70	79	79	79	80	75	86
HBA 100 T4/T8 11/3kW (A6:6) (720 RPM - 24°)	Inlet	54	64	69	78	79	79	79	75	86
HBA 100 T4/T8 15/3,5kW (A6:3) (1420 RPM - 40°)	Inlet	69	77	82	90	91	92	92	87	98
HBA 100 T4/T8 15/3,5kW (A6:3) (1420 RPM - 38°)	Inlet	69	76	82	89	90	91	91	86	97
HBA 100 T4/T8 15/3,5kW (A6:3) (720 RPM - 40°)	Inlet	53	61	66	74	75	76	76	71	82
HBA 100 T4/T8 15/3,5kW (A6:3) (720 RPM - 38°)	Inlet	53	60	66	73	74	75	75	71	81
HBA 100 T4/T8 15/3,5kW (A6:6) (1420 RPM - 32°)	Inlet	72	80	86	92	94	94	95	90	101
HBA 100 T4/T8 15/3,5kW (A6:6) (1420 RPM - 30°)	Inlet	73	81	87	94	95	95	97	92	102
HBA 100 T4/T8 15/3,5kW (A6:6) (720 RPM - 32°)	Inlet	57	65	71	76	78	78	79	74	85
HBA 100 T4/T8 15/3,5kW (A6:6) (720 RPM - 30°)	Inlet	57	65	72	78	79	79	81	76	86
HBA 100 T4/T8 17/4,3kW (A6:6) (1420 RPM - 36°)	Inlet	71	79	85	89	92	92	94	88	99
HBA 100 T4/T8 17/4,3kW (A6:6) (1420 RPM - 34°)	Inlet	72	80	86	90	92	93	94	89	99
HBA 100 T4/T8 17/4,3kW (A6:6) (720 RPM - 36°)	Inlet	55	63	69	73	76	76	78	72	83
HBA 100 T4/T8 17/4,3kW (A6:6) (720 RPM - 34°)	Inlet	56	64	70	74	76	77	78	73	83
HBA 100 T4/T8 20/5kW (A6:6) (1420 RPM - 38°)	Inlet	72	80	86	90	92	93	94	89	99
HBA 100 T4/T8 20/5kW (A6:6) (720 RPM - 38°)	Inlet	56	64	70	74	77	77	78	73	84

**Sound power Lw dB (A)**

Model		63 Hz	125 Hz	250 Hz	500 Hz	1000 Hz	2000 Hz	4000 Hz	8000 Hz	Total
HBA 112 T4/T8 5,5/1,1kW (A6:3) (1420 RPM - 22°)	Inlet	69	76	81	87	92	93	95	90	99
HBA 112 T4/T8 5,5/1,1kW (A6:3) (720 RPM - 22°)	Inlet	53	60	65	71	76	77	79	74	83
HBA 112 T4/T8 5,5/1,1kW (A6:3) (1420 RPM - 20°)	Inlet	67	74	79	86	91	92	94	89	99
HBA 112 T4/T8 7,5/1,5kW (A6:3) (1420 RPM - 26°)	Inlet	71	77	83	89	92	93	96	90	100
HBA 112 T4/T8 7,5/1,5kW (A6:3) (720 RPM - 26°)	Inlet	55	61	67	73	76	77	80	75	84
HBA 112 T4/T8 7,5/1,5kW (A6:3) (1420 RPM - 24°)	Inlet	70	77	82	88	92	93	95	90	100
HBA 112 T4/T8 7,5/1,5kW (A6:3) (720 RPM - 24°)	Inlet	54	61	66	72	76	77	80	74	84
HBA 112 T4/T8 11/3kW (A6:3) (1420 RPM - 30°)	Inlet	71	77	83	89	92	92	95	90	99
HBA 112 T4/T8 11/3kW (A6:3) (1420 RPM - 28°)	Inlet	71	77	83	89	92	93	95	90	100
HBA 112 T4/T8 11/3kW (A6:3) (720 RPM - 30°)	Inlet	55	61	67	73	76	76	79	74	83
HBA 112 T4/T8 11/3kW (A6:3) (720 RPM - 28°)	Inlet	55	61	67	73	76	77	79	74	84
HBA 112 T4/T8 11/3kW (A6:6) (1420 RPM - 22°)	Inlet	70	80	86	96	98	97	98	93	104
HBA 112 T4/T8 11/3kW (A6:6) (720 RPM - 22°)	Inlet	54	65	70	81	82	81	82	77	88
HBA 112 T4/T8 11/3kW (A6:6) (1420 RPM - 20°)	Inlet	69	80	86	97	98	97	98	93	104
HBA 112 T4/T8 15/3,5kW (A6:3) (1420 RPM - 34°)	Inlet	73	77	85	90	92	92	94	90	99
HBA 112 T4/T8 15/3,5kW (A6:3) (1420 RPM - 32°)	Inlet	72	77	84	89	92	92	94	90	99
HBA 112 T4/T8 15/3,5kW (A6:3) (720 RPM - 34°)	Inlet	57	61	69	74	76	76	78	74	83
HBA 112 T4/T8 15/3,5kW (A6:3) (720 RPM - 32°)	Inlet	56	61	68	74	76	76	79	74	83
HBA 112 T4/T8 15/3,5kW (A6:3) (1420 RPM - 36°)	Inlet	73	78	85	90	92	93	94	90	99
HBA 112 T4/T8 15/3,5kW (A6:3) (720 RPM - 36°)	Inlet	57	62	69	74	76	77	78	74	83
HBA 112 T4/T8 15/3,5kW (A6:6) (1420 RPM - 26°)	Inlet	72	81	86	95	97	97	98	92	104
HBA 112 T4/T8 15/3,5kW (A6:6) (1420 RPM - 24°)	Inlet	71	80	86	95	97	96	97	92	103
HBA 112 T4/T8 15/3,5kW (A6:6) (720 RPM - 26°)	Inlet	57	65	70	79	81	81	82	76	88

**Sound power Lw dB (A)**

Model		63 Hz	125 Hz	250 Hz	500 Hz	1000 Hz	2000 Hz	4000 Hz	8000 Hz	Total
HBA 112 T4/T8 15/3,5kW (A6:6) (720 RPM - 24°)	Inlet	55	64	70	80	81	80	81	76	87
HBA 112 T4/T8 15/3,5kW (A6:6) (1420 RPM - 28°)	Inlet	74	82	87	95	97	97	98	92	104
HBA 112 T4/T8 15/3,5kW (A6:6) (720 RPM - 28°)	Inlet	58	66	71	79	81	81	82	76	88
HBA 112 T4/T8 17/4,3kW (A6:3) (1420 RPM - 38°)	Inlet	73	79	85	91	93	93	94	90	100
HBA 112 T4/T8 17/4,3kW (A6:3) (720 RPM - 38°)	Inlet	57	63	69	75	77	78	78	74	84
HBA 112 T4/T8 17/4,3kW (A6:6) (1420 RPM - 30°)	Inlet	75	82	87	94	96	97	98	91	103
HBA 112 T4/T8 17/4,3kW (A6:6) (720 RPM - 30°)	Inlet	59	66	71	78	80	81	82	75	87
HBA 112 T4/T8 20/5kW (A6:3) (1420 RPM - 40°)	Inlet	73	79	85	91	93	94	94	90	100
HBA 112 T4/T8 20/5kW (A6:3) (720 RPM - 40°)	Inlet	57	63	69	75	77	78	78	74	84
HBA 112 T4/T8 20/5kW (A6:6) (1420 RPM - 32°)	Inlet	74	81	86	92	95	96	97	90	102
HBA 112 T4/T8 20/5kW (A6:6) (720 RPM - 32°)	Inlet	59	66	71	77	79	80	81	74	86
HBA 112 T4/T8 28/6,5kW (A6:6) (1420 RPM - 38°)	Inlet	77	83	89	92	96	97	98	91	103
HBA 112 T4/T8 28/6,5kW (A6:6) (1420 RPM - 36°)	Inlet	75	82	87	91	94	95	96	89	102
HBA 112 T4/T8 28/6,5kW (A6:6) (1420 RPM - 34°)	Inlet	74	81	86	91	94	95	96	89	101
HBA 112 T4/T8 28/6,5kW (A6:6) (720 RPM - 38°)	Inlet	61	67	73	77	80	81	82	75	87
HBA 112 T4/T8 28/6,5kW (A6:6) (720 RPM - 36°)	Inlet	59	66	71	75	78	80	80	73	86
HBA 112 T4/T8 28/6,5kW (A6:6) (720 RPM - 34°)	Inlet	58	65	70	75	78	79	80	73	85
HBA 112 T4/T8 35/8kW (A6:6) (1420 RPM - 40°)	Inlet	78	85	90	94	97	98	99	92	104
HBA 112 T4/T8 35/8kW (A6:6) (720 RPM - 40°)	Inlet	62	69	74	78	81	82	83	76	88
HBA 125 T4/T8 11/3kW (A7:4) (1420 RPM - 22°)	Inlet	75	86	91	98	102	103	105	101	109
HBA 125 T4/T8 11/3kW (A7:4) (720 RPM - 22°)	Inlet	59	70	75	82	86	87	89	85	93
HBA 125 T4/T8 15/3,5kW (A7:4) (1420 RPM - 24°)	Inlet	75	85	90	96	100	101	103	98	107
HBA 125 T4/T8 15/3,5kW (A7:4) (720 RPM - 24°)	Inlet	59	69	74	80	84	85	87	82	91



**Sound power Lw dB (A)**

Model		63 Hz	125 Hz	250 Hz	500 Hz	1000 Hz	2000 Hz	4000 Hz	8000 Hz	Total
HBA 125 T4/T8 15/3,5kW (A7:4) (1420 RPM - 26°)	Inlet	76	84	89	94	98	99	101	95	106
HBA 125 T4/T8 15/3,5kW (A7:4) (720 RPM - 26°)	Inlet	60	68	73	78	82	83	85	80	90
HBA 125 T4/T8 15/3,5kW (A7:8) (1420 RPM - 20°)	Inlet	77	85	92	101	107	110	109	104	115
HBA 125 T4/T8 17/4,3kW (A7:4) (1420 RPM - 28°)	Inlet	75	82	87	92	96	98	99	93	104
HBA 125 T4/T8 17/4,3kW (A7:4) (720 RPM - 28°)	Inlet	59	66	71	77	80	82	83	77	88
HBA 125 T4/T8 20/5kW (A7:4) (1420 RPM - 30°)	Inlet	74	81	86	90	94	96	97	90	102
HBA 125 T4/T8 20/5kW (A7:4) (720 RPM - 30°)	Inlet	58	65	70	74	78	80	81	74	86
HBA 125 T4/T8 20/5kW (A7:8) (1420 RPM - 22°)	Inlet	77	85	91	99	106	109	108	103	113
HBA 125 T4/T8 20/5kW (A7:8) (720 RPM - 22°)	Inlet	62	69	75	83	90	93	92	87	97
HBA 125 T4/T8 28/6,5kW (A7:4) (1420 RPM - 36°)	Inlet	74	81	86	90	93	95	96	88	101
HBA 125 T4/T8 28/6,5kW (A7:4) (1420 RPM - 34°)	Inlet	73	80	85	90	93	95	96	88	101
HBA 125 T4/T8 28/6,5kW (A7:4) (1420 RPM - 32°)	Inlet	74	81	86	90	93	95	96	89	101
HBA 125 T4/T8 28/6,5kW (A7:4) (720 RPM - 36°)	Inlet	58	65	70	75	77	79	80	72	85
HBA 125 T4/T8 28/6,5kW (A7:4) (720 RPM - 34°)	Inlet	57	64	69	74	77	79	80	72	85
HBA 125 T4/T8 28/6,5kW (A7:4) (720 RPM - 32°)	Inlet	58	65	70	74	78	79	80	73	85
HBA 125 T4/T8 28/6,5kW (A7:8) (1420 RPM - 26°)	Inlet	77	84	90	97	103	106	106	99	111
HBA 125 T4/T8 28/6,5kW (A7:8) (1420 RPM - 24°)	Inlet	77	84	91	98	105	107	107	101	112
HBA 125 T4/T8 28/6,5kW (A7:8) (720 RPM - 26°)	Inlet	61	68	74	81	87	90	90	84	95
HBA 125 T4/T8 28/6,5kW (A7:8) (720 RPM - 24°)	Inlet	61	68	75	82	89	91	91	85	96
HBA 125 T4/T8 35/8kW (A7:4) (1420 RPM - 40°)	Inlet	75	82	87	92	94	96	96	90	102
HBA 125 T4/T8 35/8kW (A7:4) (1420 RPM - 38°)	Inlet	75	82	87	91	94	96	96	89	102
HBA 125 T4/T8 35/8kW (A7:4) (720 RPM - 40°)	Inlet	59	66	71	76	78	80	81	74	86
HBA 125 T4/T8 35/8kW (A7:4) (720 RPM - 38°)	Inlet	59	66	71	76	78	80	81	73	86



**Sound power Lw dB (A)**

Model		63 Hz	125 Hz	250 Hz	500 Hz	1000 Hz	2000 Hz	4000 Hz	8000 Hz	Total
HBA 125 T4/T8 35/8kW (A7:8) (1420 RPM - 30°)	Inlet	77	83	89	95	100	103	103	96	108
HBA 125 T4/T8 35/8kW (A7:8) (1420 RPM - 28°)	Inlet	77	83	90	96	102	105	105	98	110
HBA 125 T4/T8 35/8kW (A7:8) (720 RPM - 30°)	Inlet	61	67	73	79	84	87	87	80	92
HBA 125 T4/T8 35/8kW (A7:8) (720 RPM - 28°)	Inlet	61	68	74	80	86	89	89	82	94
HBA 125 T4/T8 37/9,2kW (A7:8) (1420 RPM - 32°)	Inlet	77	83	89	94	99	101	102	94	106
HBA 125 T4/T8 37/9,2kW (A7:8) (720 RPM - 32°)	Inlet	61	67	73	79	83	85	86	78	90
HBA 125 T4/T8 44/11kW (A7:8) (1420 RPM - 34°)	Inlet	77	83	89	94	98	100	100	92	105
HBA 125 T4/T8 44/11kW (A7:8) (720 RPM - 34°)	Inlet	61	68	73	78	82	84	84	76	89