

HBF F400



WENTYLATOR OSIOWY 400°C/2h

CECHY:

- Wentylator osiowy we wzmocnionej obudowie.
- Modułowy zestaw silnik-wirnik.
- Aluminiowy wirnik ze zmiennym kątem ustawienia łopatek. Malowanie proszkowe.
- Standardowy, klatkowy silnik asynchroniczny ze stopniem ochrony IP-55 i klasą izolacji H, certyfikowany 400°C/2h. Standardowe napięcia: 230/400V 50Hz dla silników trójfazowych do 4kW oraz 400/690V 50Hz dla wyższych mocy.

ZASTOSOWANIE:

Zaprojektowany do montażu ściennego oraz kanałowego, przeznaczony do:

- Awaryjny wyciąg dymów i gazów pożarowych wewnątrz zagrożonej strefy.
- Wyciąg powietrza o maksymalnej temperaturze ciągłej: 60°C.

NA ZAPYTANIE:

- Wirnik nawiewny (przepływ powietrza od wirnika do silnika).
- 100% rewersyjność.

Oficjalna homologacja przez laboratorium europejskie APPLUS zgodnie z EN 12101-3:2002, EN 12101-3:2002/AC:2005
Certyfikat Nr: 0370-CPD-0914

Akcesoria



AC



BA-400



CPM



INT



INT 400



MC HB



RP0



RP1



SFC

Dane techniczne

Silnik trójfazowy / 4-biegunowy

Kod	Model	R.P.M.	Natężenie I (400V) A	Moc nominalna kW	Maks. Przepływ m ³ /h	Hałas db (A)*	Masa	Schemat połączenia
26047606__AF	HBF 45 T4 0,75kW (A5:6) F400	1404	1,95	0,75	6.650	50	22	1
26050606__AF	HBF 50 T4 0,75kW (A5:6) F400	1404	1,95	0,75	8.760	52	30	1
26058656__AF	HBF 56 T4 0,75kW (A5:6) F400	1404	1,95	0,75	10.270	57	58	1
26060656__AF	HBF 56 T4 1,1kW (A5:6) F400	1392	2,7	1,10	11.890	56	63	1
26061656__AF	HBF 56 T4 1,5kW (A5:6) F400	1410	3,6	1,50	13.870	57	64	1
26065656__AF	HBF 63 T4 0,75kW (A5:6) F400	1404	1,95	0,75	11.420	60	54	1
26066656__AF	HBF 63 T4 1,1kW (A5:6) F400	1392	2,7	1,10	14.010	61	59	1
26067656__AF	HBF 63 T4 1,5kW (A5:6) F400	1410	3,6	1,50	15.780	57	60	1
26068656__AF	HBF 63 T4 2,2kW (A5:6) F400	1420	4,55	2,20	17.690	58	66	1
26072656__AF	HBF 71 T4 0,75kW (A5:6) F400	1404	1,95	0,75	12.950	65	64	1
26073656__AF	HBF 71 T4 1,1kW (A5:6) F400	1392	2,7	1,10	15.960	64	66	1
26074656__AF	HBF 71 T4 1,5kW (A5:6) F400	1410	3,6	1,50	18.960	63	67	1
26075656__AF	HBF 71 T4 2,2kW (A5:6) F400	1420	4,55	2,20	22.040	61	69	1
26076656__AF	HBF 71 T4 3kW (A5:6) F400	1420	6,12	3	23.900	63	72	1
26084656__AF	HBF 80 T4 3kW (A5:6) F400	1420	6,12	3	29.500	63	80	1
26085656__AF	HBF 80 T4 4kW (A5:6) F400	1428	8,57	4	32.300	64	93	1
26093634__AF	HBF 90 T4 3kW (A3:4) F400	1420	6,12	3	27.600	66	89	1
26094634__AF	HBF 90 T4 4kW (A3:4) F400	1428	8,57	4	32.700	65	102	1
26095634__AF	HBF 90 T4 5,5kW (A3:4) F400	1450	10,5	5,50	39.500	63	115	1
26095638__AF	HBF 90 T4 5,5kW (A3:8) F400	1450	10,5	5,50	32.000	70	119	1
26096634__AF	HBF 90 T4 7,5kW (A3:4) F400	1453	14,1	7,50	44.600	63	129	1
26096638__AF	HBF 90 T4 7,5kW (A3:8) F400	1453	14,1	7,50	37.100	68	133	1
26097634__AF	HBF 90 T4 11kW (A3:4) F400	1470	21,2	11	46.300	65	159	1
26097638__AF	HBF 90 T4 11kW (A3:8) F400	1470	21,2	11	47.600	66	160	1
26098638__AF	HBF 90 T4 15kW (A3:8) F400	1465	28,7	15	52.600	66	188	1
26014634__AF	HBF 100 T4 5,5kW (A3:4) F400	1450	10,5	5,50	45.600	71	123	1
26015634__AF	HBF 100 T4 7,5kW (A3:4) F400	1453	14,1	7,50	51.400	71	137	1
26015638__AF	HBF 100 T4 7,5kW (A3:8) F400	1453	14,1	7,50	39.400	81	140	1
26016634__AF	HBF 100 T4 11kW (A3:4) F400	1470	21,2	11	62.300	70	164	1
26016638__AF	HBF 100 T4 11kW (A3:8) F400	1470	21,2	11	52.500	76	167	1
26017634__AF	HBF 100 T4 15kW (A3:4) F400	1465	28,7	15	65.200	71	192	1
26017638__AF	HBF 100 T4 15kW (A3:8) F400	1465	28,7	15	63.600	73	195	1
26018638__AF	HBF 100 T4 18,5kW (A3:8) F400	1465	35,1	18,50	71.300	73	243	1
26019638__AF	HBF 100 T4 22kW (A3:8) F400	1465	40,5	22	75.100	74	244	1
26023634__AF	HBF 112 T4 5,5kW (A3:4) F400	1450	10,5	5,50	50.600	75	150	1

Kod	Model	R.P.M.	Natężenie I (400V) A	Moc nominalna kW	Maks. Przepływ m ³ /h	Hałas db (A)*	Masa	Schemat połączenia
26024634__AF	HBF 112 T4 7,5kW (A3:4) F400	1453	14,1	7,50	59.100	75	156	1
26025634__AF	HBF 112 T4 11kW (A3:4) F400	1470	21,2	11	75.500	72	180	1
26025638__AF	HBF 112 T4 11kW (A3:8) F400	1470	21,2	11	57.600	81	183	1
26026634__AF	HBF 112 T4 15kW (A3:4) F400	1465	28,7	15	86.200	72	205	1
26026638__AF	HBF 112 T4 15kW (A3:8) F400	1465	28,7	15	72.400	79	209	1
26027634__AF	HBF 112 T4 18,5kW (A3:4) F400	1465	35,1	18,50	89.500	73	248	1
26027638__AF	HBF 112 T4 18,5kW (A3:8) F400	1465	35,1	18,50	82.400	77	252	1
26028638__AF	HBF 112 T4 22kW (A3:8) F400	1465	40,5	22	91.800	75	253	1
26029638__AF	HBF 112 T4 30kW (A3:8) F400	1470	56,2	30	99.700	75	307	1
27006634__AF	HBF 125 T4 11kW (A3:4) F400	1470	21,2	11	74.100	83	184	1
27007634__AF	HBF 125 T4 15kW (A3:4) F400	1465	28,7	15	91.200	78	212	1
27008634__AF	HBF 125 T4 18,5kW (A3:4) F400	1465	35,1	18,50	102.000	76	260	1
27008638__AF	HBF 125 T4 18,5kW (A3:8) F400	1465	35,1	18,50	77.800	88	268	1
27009634__AF	HBF 125 T4 22kW (A3:4) F400	1465	40,5	22	112.000	75	261	1
27009638__AF	HBF 125 T4 22kW (A3:8) F400	1465	40,5	22	91.200	85	269	1
27010634__AF	HBF 125 T4 30kW (A3:4) F400	1470	56,2	30	121.000	75	321	1
27010638__AF	HBF 125 T4 30kW (A3:8) F400	1470	56,2	30	111.000	81	329	1
27011638__AF	HBF 125 T4 37kW (A3:8) F400	1475	66,6	37	124.000	78	430	1
27012638__AF	HBF 125 T4 45kW (A3:8) F400	1475	80,7	45	135.000	77	475	1

Silnik trójfazowy / 6-biegunowy

Kod	Model	R.P.M.	Natężenie I (400V) A	Moc nominalna kW	Maks. Przepływ m ³ /h	Hałas db (A)*	Masa	Schemat połączenia
26051606__AF	HBF 50 T6 0,75kW (A5:6) F400	923	2,2	0,75	6.000	43	27	1
26058656__AF	HBF 56 T6 0,75kW (A5:6) F400	923	2,2	0,75	8.330	48	57	1
26064656__AF	HBF 63 T6 0,75kW (A5:6) F400	923	2,2	0,75	11.450	50	52	1
26072656__AF	HBF 71 T6 0,75kW (A5:6) F400	923	2,2	0,75	15.440	53	60	1
26080656__AF	HBF 80 T6 0,75kW (A5:6) F400	923	2,2	0,75	17.380	59	66	1
26081656__AF	HBF 80 T6 1,1kW (A5:6) F400	920	3,1	1,10	19.520	55	70	1
26082656__AF	HBF 80 T6 1,5kW (A5:6) F400	933	3,6	1,50	21.820	55	76	1
26083656__AF	HBF 80 T6 2,2kW (A5:6) F400	948	5,23	2,20	23.930	56	85	1
26091634__AF	HBF 90 T6 1,5kW (A3:4) F400	933	3,6	1,50	25.600	54	85	1
26091638__AF	HBF 90 T6 1,5kW (A3:8) F400	933	3,6	1,50	20.700	60	89	1
26092634__AF	HBF 90 T6 2,2kW (A3:4) F400	948	5,23	2,20	30.000	54	94	1
26092638__AF	HBF 90 T6 2,2kW (A3:8) F400	948	5,23	2,20	25.700	58	97	1
26093638__AF	HBF 90 T6 3kW (A3:8) F400	965	7,42	3	30.800	57	121	1
26094638__AF	HBF 90 T6 4kW (A3:8) F400	963	8,97	4	34.100	57	127	1

Kod	Model	R.P.M.	Natężenie I (400V) A	Moc nominalna kW	Maks. Przepływ m ³ /h	Hałas db (A)*	Masa	Schemat połączenia
26010634__AF	HBF 100 T6 1,5kW (A3:4) F400	933	3,6	1,50	29.600	62	92	1
26011634__AF	HBF 100 T6 2,2kW (A3:4) F400	948	5,23	2,20	35.000	61	101	1
26011638__AF	HBF 100 T6 2,2kW (A3:8) F400	948	5,23	2,20	27.600	70	103	1
26012634__AF	HBF 100 T6 3kW (A3:4) F400	965	7,42	3	40.400	60	125	1
26012638__AF	HBF 100 T6 3kW (A3:8) F400	965	7,42	3	34.000	66	129	1
26013634__AF	HBF 100 T6 4kW (A3:4) F400	963	8,97	4	42.200	61	131	1
26013638__AF	HBF 100 T6 4kW (A3:8) F400	963	8,97	4	41.200	63	135	1
26014638__AF	HBF 100 T6 5,5kW (A3:8) F400	960	12,8	5,50	48.600	63	139	1
26020634__AF	HBF 112 T6 2,2kW (A3:4) F400	948	5,23	2,20	41.000	64	127	1
26021634__AF	HBF 112 T6 3kW (A3:4) F400	965	7,42	3	48.900	63	148	1
26021638__AF	HBF 112 T6 3kW (A3:8) F400	965	7,42	3	37.300	72	150	1
26022634__AF	HBF 112 T6 4kW (A3:4) F400	963	8,97	4	55.900	62	154	1
26022638__AF	HBF 112 T6 4kW (A3:8) F400	963	8,97	4	46.900	69	154	1
26023634__AF	HBF 112 T6 5,5kW (A3:4) F400	960	12,8	5,50	58.000	63	157	1
26023638__AF	HBF 112 T6 5,5kW (A3:8) F400	960	12,8	5,50	56.600	66	164	1
26024638__AF	HBF 112 T6 7,5kW (A3:8) F400	970	15	7,50	64.600	65	203	1
27002634__AF	HBF 125 T6 3kW (A3:4) F400	965	7,42	3	51.700	72	149	1
27003634__AF	HBF 125 T6 4kW (A3:4) F400	963	8,97	4	59.100	68	155	1
27004634__AF	HBF 125 T6 5,5kW (A3:4) F400	960	12,8	5,50	69.400	65	159	1
27004638__AF	HBF 125 T6 5,5kW (A3:8) F400	960	12,8	5,50	54.800	77	170	1
27005634__AF	HBF 125 T6 7,5kW (A3:4) F400	970	15	7,50	78.400	65	203	1
27005638__AF	HBF 125 T6 7,5kW (A3:8) F400	970	15	7,50	67.700	72	214	1
27006638__AF	HBF 125 T6 11kW (A3:8) F400	970	22	11	83.800	68	234	1
27007638__AF	HBF 125 T6 15kW (A3:8) F400	970	27,9	15	87.200	67	272	1

SILNIK 2 BIEGOWY / 4/8-biegunowy

Kod	Model	R.P.M.	Natężenie I (400V) A	Moc nominalna kW	Maks. Przepływ m ³ /h	Hałas db (A)*	Masa	Schemat połączenia
26047606__AW	HBF 45 T4/T8 0,8/0,2kW (A5:6) F400	1440	2/0,89	0.8/0.2	6.650	35	22	2
26050606__AW	HBF 50 T4/T8 0,8/0,2kW (A5:6) F400	1404	2/0,89	0.8/0.2	8.760	37	30	2
26059656__AW	HBF 56 T4/T8 0,8/0,2kW (A5:6) F400	1430	2/0,89	0.8/0.2	10.270	42	57	2
26060656__AW	HBF 56 T4/T8 1,2/0,3kW (A5:6) F400	1392	2,92/1,29	1.2/0.3	11.890	40	63	2
26061656__AW	HBF 56 T4/T8 1,6/0,4kW (A5:6) F400	1440	3,8/1,69	1.6/0.4	13.870	42	64	2
26065656__AW	HBF 63 T4/T8 0,8/0,2kW (A5:6) F400	1430	2/0,89	0.8/0.2	11.420	45	54	2
26066656__AW	HBF 63 T4/T8 1,2/0,3kW (A5:6) F400	1410	2,92/1,29	1.2/0.3	14.010	46	59	2
26067656__AW	HBF 63 T4/T8 1,6/0,4kW (A5:6) F400	1440	3,8/1,69	1.6/0.4	15.780	42	60	2
26068656__AW	HBF 63 T4/T8 2,2/0,37kW (A5:6) F400	1440	4,84/2	2.2/0.37	17.690	43	66	2

Kod	Model	R.P.M.	Natężenie I (400V) A	Moc nominalna kW	Maks. Przepływ m ³ /h	Hałas db (A)*	Masa	Schemat połączenia
26072656__AW	HBF 71 T4/T8 0,8/0,2kW (A5:6) F400	1430	2/0,89	0.8/0.2	12.950	50	64	2
26073656__AW	HBF 71 T4/T8 1,2/0,3kW (A5:6) F400	1410	2,92/1,29	1.2/0.3	15.960	49	66	2
26074656__AW	HBF 71 T4/T8 1,6/0,4kW (A5:6) F400	1440	3,8/1,69	1.6/0.4	18.960	48	67	2
26075656__AW	HBF 71 T4/T8 2,2/0,37kW (A5:6) F400	1440	4,84/2	2.2/0.37	22.040	46	69	2
26076656__AW	HBF 71 T4/T8 3/0,55kW (A5:6) F400	1428	7,1/5,1	3/0.55	23.900	48	72	2
26084656__AW	HBF 80 T4/T8 3/0,55kW (A5:6) F400	1428	7,1/5,1	3/0.55	29.500	48	80	2
26085656__AW	HBF 80 T4/T8 4/0,75kW (A5:6) F400	1430	8,6/2,6	4/0.75	32.300	49	93	2
26093634__AW	HBF 90 T4/T8 2,8/0,7kW (A3:4) F400	1440	6/2,4	2.8/0.7	27.600	50	95	2
26094634__AW	HBF 90 T4/T8 4/0,75kW (A3:4) F400	1430	8,6/2,6	4/0.75	32.700	49	102	2
26095634__AW	HBF 90 T4/T8 5,5/1,1kW (A3:4) F400	1454	10,9/3,32	5.5/1.1	39.500	47	115	2
26095638__AW	HBF 90 T4/T8 5,5/1,1kW (A3:8) F400	1454	10,9/3,32	5.5/1.1	29.400	55	119	2
26096634__AW	HBF 90 T4/T8 7,5/1,5kW (A3:4) F400	1461	14,9/3,7	7.5/1.5	44.600	47	129	2
26096638__AW	HBF 90 T4/T8 7,5/1,5kW (A3:8) F400	1461	14,9/3,7	7.5/1.5	37.100	53	133	2
26097634__AW	HBF 90 T4/T8 11/3kW (A3:4) F400	1455	21,7/7	11/3	46.300	49	159	2
26097638__AW	HBF 90 T4/T8 11/3kW (A3:8) F400	1455	21,7/7	11/3	47.600	50	160	2
26098638__AW	HBF 90 T4/T8 14/3,5kW (A3:8) F400	1450	26,5/8,45	14/3.5	52.600	51	190	2
26014634__AW	HBF 100 T4/T8 5,5/1,1kW (A3:4) F400	1454	10,9/3,32	5.5/1.1	45.600	56	123	2
26015634__AW	HBF 100 T4/T8 7,5/1,5kW (A3:4) F400	1461	14,9/3,7	7.5/1.5	51.400	55	137	2
26015638__AW	HBF 100 T4/T8 7,5/1,5kW (A3:8) F400	1461	14,9/3,7	7.5/1.5	39.400	65	140	2
26016634__AW	HBF 100 T4/T8 11/3kW (A3:4) F400	1455	21,7/7	11/3	62.300	54	164	2
26016638__AW	HBF 100 T4/T8 11/3kW (A3:8) F400	1455	21,7/7	11/3	52.500	60	167	2
26017634__AW	HBF 100 T4/T8 14/3,5kW (A3:4) F400	1450	26,5/8,45	14/3.5	65.200	55	170	2
26017638__AW	HBF 100 T4/T8 14/3,5kW (A3:8) F400	1450	26,5/8,45	14/3.5	59.700	58	173	2
26018638__AW	HBF 100 T4/T8 17/4,3kW (A3:8) F400	1475	33,4/12,7	17/4.3	67.500	57	185	2
26019638__AW	HBF 100 T4/T8 20/5kW (A3:8) F400	1470	38,6/14,1	20/5	75.100	57	195	2
26023634__AW	HBF 112 T4/T8 5,5/1,1kW (A3:4) F400	1454	10,9/3,32	5.5/1.1	50.600	59	140	2
26024634__AW	HBF 112 T4/T8 7,5/1,5kW (A3:4) F400	1461	14,9/3,7	7.5/1.5	59.100	59	156	2
26025634__AW	HBF 112 T4/T8 11/3kW (A3:4) F400	1455	21,7/7	11/3	75.500	56	180	2
26025638__AW	HBF 112 T4/T8 11/3kW (A3:8) F400	1455	21,7/7	11/3	52.700	67	183	2
26026634__AW	HBF 112 T4/T8 14/3,5kW (A3:4) F400	1450	26,5/8,45	14/3.5	82.900	56	190	2
26026638__AW	HBF 112 T4/T8 14/3,5kW (A3:8) F400	1450	26,5/8,45	14/3.5	67.500	64	193	2
26026634__AW	HBF 112 T4/T8 17/4,3kW (A3:4) F400	1475	33,4/12,7	17/4.3	89.500	56	185	2
26026638__AW	HBF 112 T4/T8 17/4,3kW (A3:8) F400	1475	33,4/12,7	17/4.3	77.400	62	189	2
26028638__AW	HBF 112 T4/T8 20/5kW (A3:8) F400	1470	38,6/14,1	20/5	82.400	61	209	2
26028638__AW	HBF 112 T4/T8 28/6,5kW (A3:8) F400	1480	52/18	28/6.5	99.700	59	252	2
27006634__AW	HBF 125 T4/T8 11/3kW (A3:4) F400	1455	21,7/7	11/3	74.100	67	184	2
27007634__AW	HBF 125 T4/T8 14/3,5kW (A3:4) F400	1450	26,5/8,45	14/3.5	85.500	64	184	2
27008634__AW	HBF 125 T4/T8 17/4,3kW (A3:4) F400	1475	33,4/12,7	17/4.3	96.900	60	184	2
27009634__AW	HBF 125 T4/T8 20/5kW (A3:4) F400	1470	38,6/14,1	20/5	107.000	59	212	2

Kod	Model	R.P.M.	Natężenie I (400V) A	Moc nominalna kW	Maks. Przepływ m ³ /h	Hałas db (A)*	Masa	Schemat połączenia
27008638__AW	HBF 125 T4/T8 20/5kW (A3:8) F400	1470	38,6/14,1	20/5	84.500	71	217	2
27009634__AW	HBF 125 T4/T8 28/6,5kW (A3:4) F400	1480	52/18	28/6.5	121.000	59	260	2
27010638__AW	HBF 125 T4/T8 28/6,5kW (A3:8) F400	1480	52/18	28/6.5	105.000	66	268	2
27011638__AW	HBF 125 T4/T8 37/9,2kW (A3:8) F400	1485	74,2/25,4	37/9.2	124.000	62	280	2
27012638__AW	HBF 125 T4/T8 44/11kW (A3:8) F400	1480	80,2/27,2	44/11	135.000	61	475	2

Uwagi:

* Całkowity poziom ciśnienia akustycznego w punkcie maksymalnego natężenia przepływu mierzony w dB (A) w wolnym polu w odległości 6 m od źródła

Wymiary

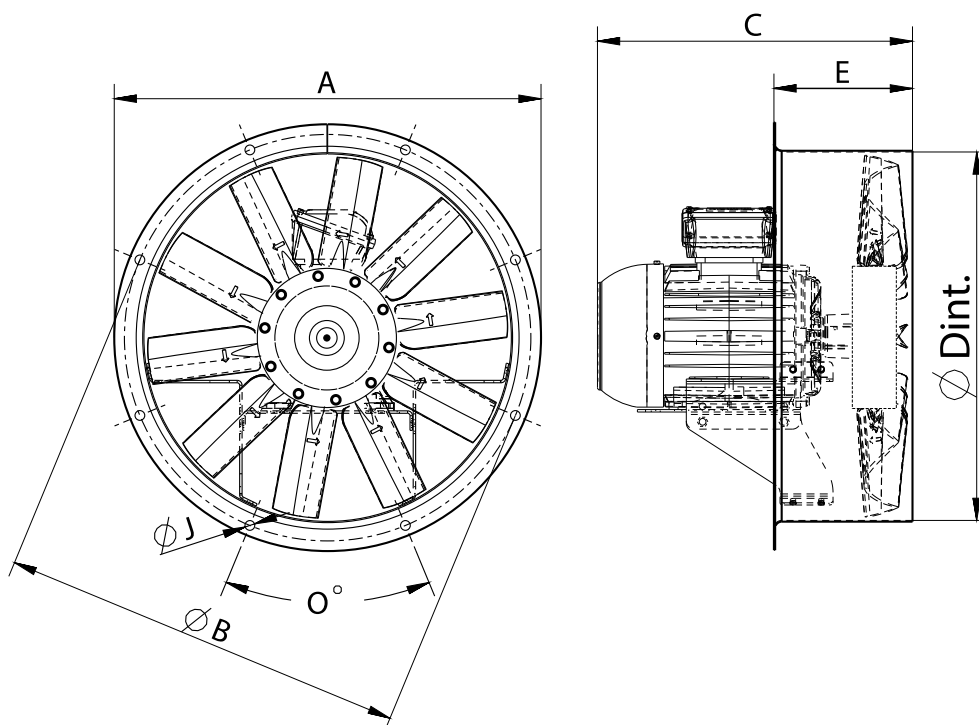

Model	C	E	O	ØA	ØB	ØDint	ØI
HBF 45 T4 0,75kW (A5:6) F400	347	165	8x45°	525	500	452	12
HBF 45 T4/T8 0,8/0,2kW (A5:6) F400	347	165	8x45°	525	500	452	12
HBF 50 T4 0,75kW (A5:6) F400	350	165	12x30°	600	560	504	12
HBF 50 T6 0,75kW (A5:6) F400	362	165	12x30°	600	560	504	12
HBF 50 T4/T8 0,8/0,2kW (A5:6) F400	350	165	12x30°	600	560	504	12
HBF 56 T4 0,75kW (A5:6) F400	352	185	12x30°	646	620	559	12
HBF 56 T4 1,1kW (A5:6) F400	362	185	12x30°	646	620	559	12
HBF 56 T4 1,5kW (A5:6) F400	387	185	12x30°	646	620	559	12
HBF 56 T6 0,75kW (A5:6) F400	362	185	12x30°	646	620	559	12
HBF 56 T4/T8 0,8/0,2kW (A5:6) F400	362	185	12x30°	646	620	559	12
HBF 56 T4/T8 1,2/0,3kW (A5:6) F400	362	185	12x30°	646	620	559	12
HBF 56 T4/T8 1,6/0,4kW (A5:6) F400	387	185	12x30°	646	620	559	12
HBF 63 T4 0,75kW (A5:6) F400	352	185	12x30°	725	690	633	12
HBF 63 T4 1,1kW (A5:6) F400	386	185	12x30°	725	690	633	12
HBF 63 T4 1,5kW (A5:6) F400	411	185	12x30°	725	690	633	12
HBF 63 T4 2,2kW (A5:6) F400	627	185	12x30°	725	690	633	12
HBF 63 T6 0,75kW (A5:6) F400	386	185	12x30°	725	690	633	12
HBF 63 T4/T8 0,8/0,2kW (A5:6) F400	352	185	12x30°	725	690	633	12
HBF 63 T4/T8 1,2/0,3kW (A5:6) F400	386	185	12x30°	725	690	633	12

Model	C	E	O	ØA	ØB	ØDint	ØI
HBF 63 T4/T8 1,6/0,4kW (A5:6) F400	411	185	12x30°	725	690	633	12
HBF 63 T4/T8 2,2/0,37kW (A5:6) F400	627	185	12x30°	725	690	633	12
HBF 71 T4 0,75kW (A5:6) F400	357	190	16x22,5°	802	770	715	12
HBF 71 T4 1,1kW (A5:6) F400	391	190	16x22,5°	802	770	715	12
HBF 71 T4 1,5kW (A5:6) F400	416	190	16x22,5°	802	770	715	12
HBF 71 T4 2,2kW (A5:6) F400	447	190	16x22,5°	802	770	715	12
HBF 71 T4 3kW (A5:6) F400	447	190	16x22,5°	802	770	715	12
HBF 71 T6 0,75kW (A5:6) F400	391	190	16x22,5°	802	770	715	12
HBF 71 T4/T8 0,8/0,2kW (A5:6) F400	357	190	16x22,5°	802	770	715	12
HBF 71 T4/T8 1,2/0,3kW (A5:6) F400	391	190	16x22,5°	802	770	715	12
HBF 71 T4/T8 1,6/0,4kW (A5:6) F400	416	190	16x22,5°	802	770	715	12
HBF 71 T4/T8 2,2/0,37kW (A5:6) F400	447	190	16x22,5°	802	770	715	12
HBF 71 T4/T8 3/0,55kW (A5:6) F400	447	190	16x22,5°	802	770	715	12
HBF 80 T4 3kW (A5:6) F400	463	220	16x22,5°	892	860	801	12
HBF 80 T4 4kW (A5:6) F400	469	220	16x22,5°	892	860	801	12
HBF 80 T6 0,75kW (A5:6) F400	427	220	16x22,5°	892	860	801	12
HBF 80 T6 1,1kW (A5:6) F400	427	220	16x22,5°	892	860	801	12
HBF 80 T6 1,5kW (A5:6) F400	463	220	16x22,5°	892	860	801	12
HBF 80 T6 2,2kW (A5:6) F400	469	220	16x22,5°	892	860	801	12
HBF 80 T4/T8 3/0,55kW (A5:6) F400	463	220	16x22,5°	892	860	801	12
HBF 80 T4/T8 4/0,75kW (A5:6) F400	469	220	16x22,5°	892	860	801	12
HBF 90 T4 3kW (A3:4) F400	658	340	16x22,5°	1000	970	903,5	12
HBF 90 T4 4kW (A3:4) F400	658	340	16x22,5°	1000	970	903,5	12
HBF 90 T4 5,5kW (A3:4) F400	658	340	16x22,5°	1000	970	903,5	12
HBF 90 T4 5,5kW (A3:8) F400	658	340	16x22,5°	1000	970	903,5	12
HBF 90 T4 7,5kW (A3:4) F400	658	340	16x22,5°	1000	970	903,5	12
HBF 90 T4 7,5kW (A3:8) F400	658	340	16x22,5°	1000	970	903,5	12
HBF 90 T4 11kW (A3:4) F400	721	340	16x22,5°	1000	970	903,5	12
HBF 90 T4 11kW (A3:8) F400	721	340	16x22,5°	1000	970	903,5	12
HBF 90 T4 15kW (A3:8) F400	742	340	16x22,5°	1000	970	903,5	12
HBF 90 T6 1,5kW (A3:4) F400	658	340	16x22,5°	1000	970	903,5	12
HBF 90 T6 1,5kW (A3:8) F400	658	340	16x22,5°	1000	970	903,5	12
HBF 90 T6 2,2kW (A3:4) F400	658	340	16x22,5°	1000	970	903,5	12
HBF 90 T6 2,2kW (A3:8) F400	658	340	16x22,5°	1000	970	903,5	12
HBF 90 T6 3kW (A3:8) F400	658	340	16x22,5°	1000	970	903,5	12
HBF 90 T6 4kW (A3:8) F400	658	340	16x22,5°	1000	970	903,5	12
HBF 90 T4/T8 2,8/0,7kW (A3:4) F400	658	340	16x22,5°	1000	970	903,5	12
HBF 90 T4/T8 4/0,75kW (A3:4) F400	658	340	16x22,5°	1000	970	903,5	12
HBF 90 T4/T8 5,5/1,1kW (A3:4) F400	658	340	16x22,5°	1000	970	903,5	12
HBF 90 T4/T8 5,5/1,1kW (A3:8) F400	658	340	16x22,5°	1000	970	903,5	12

Model	C	E	O	ØA	ØB	ØDint	ØI
HBF 90 T4/T8 7,5/1,5kW (A3:4) F400	658	340	16x22,5°	1000	970	903,5	12
HBF 90 T4/T8 7,5/1,5kW (A3:8) F400	658	340	16x22,5°	1000	970	903,5	12
HBF 90 T4/T8 11/3kW (A3:4) F400	721	340	16x22,5°	1000	970	903,5	12
HBF 90 T4/T8 11/3kW (A3:8) F400	721	340	16x22,5°	1000	970	903,5	12
HBF 90 T4/T8 14/3,5kW (A3:8) F400	742	340	16x22,5°	1000	970	903,5	12
HBF 100 T4 5,5kW (A3:4) F400	653	340	16x22,5°	1115	1070	1013	12
HBF 100 T4 7,5kW (A3:4) F400	653	340	16x22,5°	1115	1070	1013	12
HBF 100 T4 7,5kW (A3:8) F400	653	340	16x22,5°	1115	1070	1013	12
HBF 100 T4 11kW (A3:4) F400	716	340	16x22,5°	1115	1070	1013	12
HBF 100 T4 11kW (A3:8) F400	716	340	16x22,5°	1115	1070	1013	12
HBF 100 T4 15kW (A3:4) F400	738	340	16x22,5°	1115	1070	1013	12
HBF 100 T4 15kW (A3:8) F400	738	340	16x22,5°	1115	1070	1013	12
HBF 100 T4 18,5kW (A3:8) F400	776	340	16x22,5°	1115	1070	1013	12
HBF 100 T4 22kW (A3:8) F400	792	340	16x22,5°	1115	1070	1013	12
HBF 100 T6 1,5kW (A3:4) F400	653	340	16x22,5°	1115	1070	1013	12
HBF 100 T6 2,2kW (A3:4) F400	653	340	16x22,5°	1115	1070	1013	12
HBF 100 T6 2,2kW (A3:8) F400	653	340	16x22,5°	1115	1070	1013	12
HBF 100 T6 3kW (A3:4) F400	653	340	16x22,5°	1115	1070	1013	12
HBF 100 T6 3kW (A3:8) F400	653	340	16x22,5°	1115	1070	1013	12
HBF 100 T6 4kW (A3:4) F400	653	340	16x22,5°	1115	1070	1013	12
HBF 100 T6 4kW (A3:8) F400	653	340	16x22,5°	1115	1070	1013	12
HBF 100 T6 5,5kW (A3:8) F400	653	340	16x22,5°	1115	1070	1013	12
HBF 100 T4/T8 5,5/1,1kW (A3:4) F400	653	340	16x22,5°	1115	1070	1013	12
HBF 100 T4/T8 7,5/1,5kW (A3:4) F400	653	340	16x22,5°	1115	1070	1013	12
HBF 100 T4/T8 7,5/1,5kW (A3:8) F400	653	340	16x22,5°	1115	1070	1013	12
HBF 100 T4/T8 11/3kW (A3:4) F400	716	340	16x22,5°	1115	1070	1013	12
HBF 100 T4/T8 11/3kW (A3:8) F400	716	340	16x22,5°	1115	1070	1013	12
HBF 100 T4/T8 14/3,5kW (A3:4) F400	738	340	16x22,5°	1115	1070	1013	12
HBF 100 T4/T8 14/3,5kW (A3:8) F400	738	340	16x22,5°	1115	1070	1013	12
HBF 100 T4/T8 17/4,3kW (A3:8) F400	776	340	16x22,5°	1115	1070	1013	12
HBF 100 T4/T8 20/5kW (A3:8) F400	792	340	16x22,5°	1115	1070	1013	12
HBF 112 T4 5,5kW (A3:4) F400	760	340	16x22,5°	1234	1190	1132	12
HBF 112 T4 7,5kW (A3:4) F400	760	340	16x22,5°	1234	1190	1132	12
HBF 112 T4 11kW (A3:4) F400	760	340	16x22,5°	1234	1190	1132	12
HBF 112 T4 11kW (A3:8) F400	760	340	16x22,5°	1234	1190	1132	12
HBF 112 T4 15kW (A3:4) F400	760	340	16x22,5°	1234	1190	1132	12
HBF 112 T4 15kW (A3:8) F400	760	340	16x22,5°	1234	1190	1132	12
HBF 112 T4 18,5kW (A3:4) F400	761	340	16x22,5°	1234	1190	1132	12
HBF 112 T4 18,5kW (A3:8) F400	761	340	16x22,5°	1234	1190	1132	12
HBF 112 T4 22kW (A3:8) F400	780	340	16x22,5°	1234	1190	1132	12

Model	C	E	O	ØA	ØB	ØDint	ØI
HBF 112 T4 30kW (A3:8) F400	864	340	16x22,5°	1234	1190	1132	12
HBF 112 T6 2,2kW (A3:4) F400	760	340	16x22,5°	1234	1190	1132	12
HBF 112 T6 3kW (A3:4) F400	760	340	16x22,5°	1234	1190	1132	12
HBF 112 T6 3kW (A3:8) F400	760	340	16x22,5°	1234	1190	1132	12
HBF 112 T6 4kW (A3:4) F400	760	340	16x22,5°	1234	1190	1132	12
HBF 112 T6 4kW (A3:8) F400	760	340	16x22,5°	1234	1190	1132	12
HBF 112 T6 5,5kW (A3:4) F400	760	340	16x22,5°	1234	1190	1132	12
HBF 112 T6 5,5kW (A3:8) F400	760	340	16x22,5°	1234	1190	1132	12
HBF 112 T6 7,5kW (A3:8) F400	760	340	16x22,5°	1234	1190	1132	12
HBF 112 T4/T8 5,5/1,1kW (A3:4) F400	760	340	16x22,5°	1234	1190	1132	12
HBF 112 T4/T8 7,5/1,5kW (A3:4) F400	760	340	16x22,5°	1234	1190	1132	12
HBF 112 T4/T8 11/3kW (A3:4) F400	760	340	16x22,5°	1234	1190	1132	12
HBF 112 T4/T8 11/3kW (A3:8) F400	760	340	16x22,5°	1234	1190	1132	12
HBF 112 T4/T8 14/3,5kW (A3:4) F400	760	340	16x22,5°	1234	1190	1132	12
HBF 112 T4/T8 14/3,5kW (A3:8) F400	760	340	16x22,5°	1234	1190	1132	12
HBF 112 T4/T8 17/4,3kW (A3:4) F400	761	340	16x22,5°	1234	1190	1132	12
HBF 112 T4/T8 17/4,3kW (A3:8) F400	761	340	16x22,5°	1234	1190	1132	12
HBF 112 T4/T8 20/5kW (A3:8) F400	780	340	16x22,5°	1234	1190	1132	12
HBF 112 T4/T8 28/6,5kW (A3:8) F400	864	340	16x22,5°	1234	1190	1132	12
HBF 125 T4 11kW (A3:4) F400	759	340	20x18°	1365	1320	1263	15
HBF 125 T4 15kW (A3:4) F400	759	340	20x18°	1365	1320	1263	15
HBF 125 T4 18,5kW (A3:4) F400	760	340	20x18°	1365	1320	1263	15
HBF 125 T4 18,5kW (A3:8) F400	760	340	20x18°	1365	1320	1263	15
HBF 125 T4 22kW (A3:4) F400	779	340	20x18°	1365	1320	1263	15
HBF 125 T4 22kW (A3:8) F400	779	340	20x18°	1365	1320	1263	15
HBF 125 T4 30kW (A3:4) F400	863	340	20x18°	1365	1320	1263	15
HBF 125 T4 30kW (A3:8) F400	863	340	20x18°	1365	1320	1263	15
HBF 125 T4 37kW (A3:8) F400	948	340	20x18°	1365	1320	1263	15
HBF 125 T4 45kW (A3:8) F400	948	340	20x18°	1365	1320	1263	15
HBF 125 T6 3kW (A3:4) F400	759	340	20x18°	1365	1320	1263	15
HBF 125 T6 4kW (A3:4) F400	759	340	20x18°	1365	1320	1263	15
HBF 125 T6 5,5kW (A3:4) F400	759	340	20x18°	1365	1320	1263	15
HBF 125 T6 5,5kW (A3:8) F400	759	340	20x18°	1365	1320	1263	15
HBF 125 T6 7,5kW (A3:4) F400	759	340	20x18°	1365	1320	1263	15
HBF 125 T6 7,5kW (A3:8) F400	759	340	20x18°	1365	1320	1263	15
HBF 125 T6 11kW (A3:8) F400	759	340	20x18°	1365	1320	1263	15
HBF 125 T6 15kW (A3:8) F400	779	340	20x18°	1365	1320	1263	15
HBF 125 T4/T8 11/3kW (A3:4) F400	759	340	20x18°	1365	1320	1263	15
HBF 125 T4/T8 14/3,5kW (A3:4) F400	759	340	20x18°	1365	1320	1263	15
HBF 125 T4/T8 17/4,3kW (A3:4) F400	760	340	20x18°	1365	1320	1263	15

Model	C	E	O	ØA	ØB	ØDint	ØI
HBF 125 T4/T8 20/5kW (A3:4) F400	779	340	20x18°	1365	1320	1263	15
HBF 125 T4/T8 20/5kW (A3:8) F400	779	340	20x18°	1365	1320	1263	15
HBF 125 T4/T8 28/6,5kW (A3:4) F400	863	340	20x18°	1365	1320	1263	15
HBF 125 T4/T8 28/6,5kW (A3:8) F400	863	340	20x18°	1365	1320	1263	15
HBF 125 T4/T8 37/9,2kW (A3:8) F400	948	340	20x18°	1365	1320	1263	15
HBF 125 T4/T8 44/11kW (A3:8) F400	948	340	20x18°	1365	1320	1263	15

Schematy połączeń

DIAGRAM N° 1

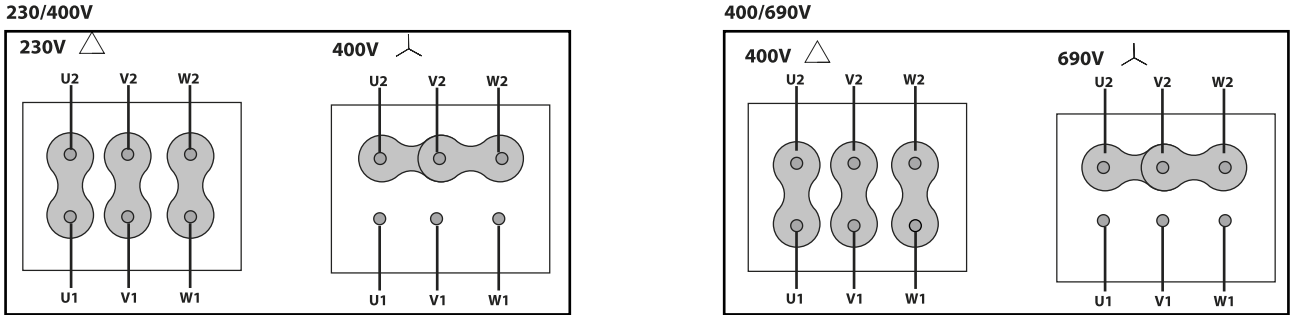
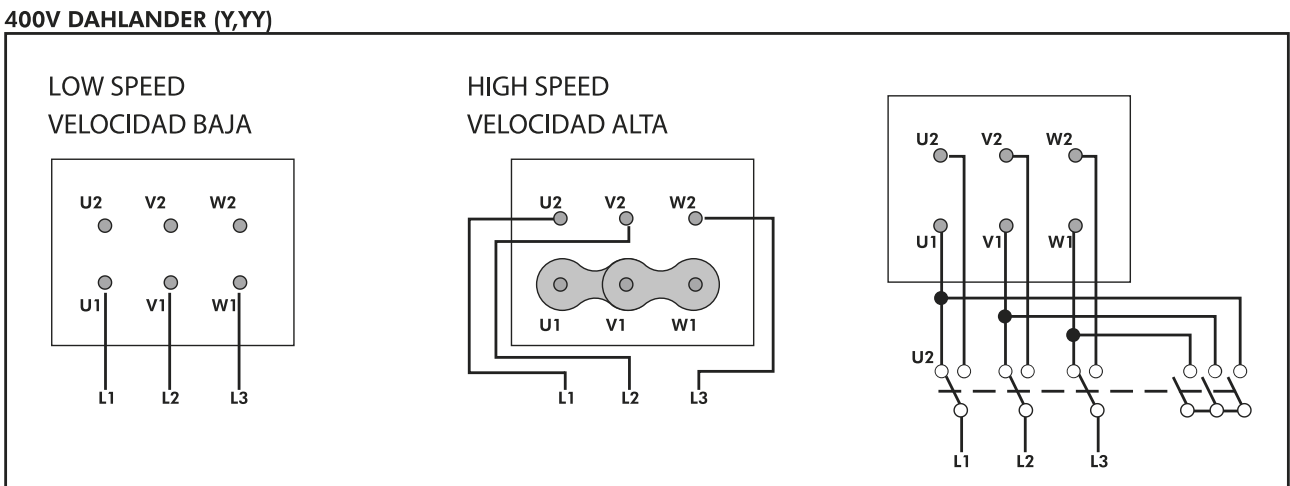

DIAGRAM N° 2



Charakterystyki

HBF 45 T4 0,75kW (A5:6) F400

AIR FLOW - PRESSURE

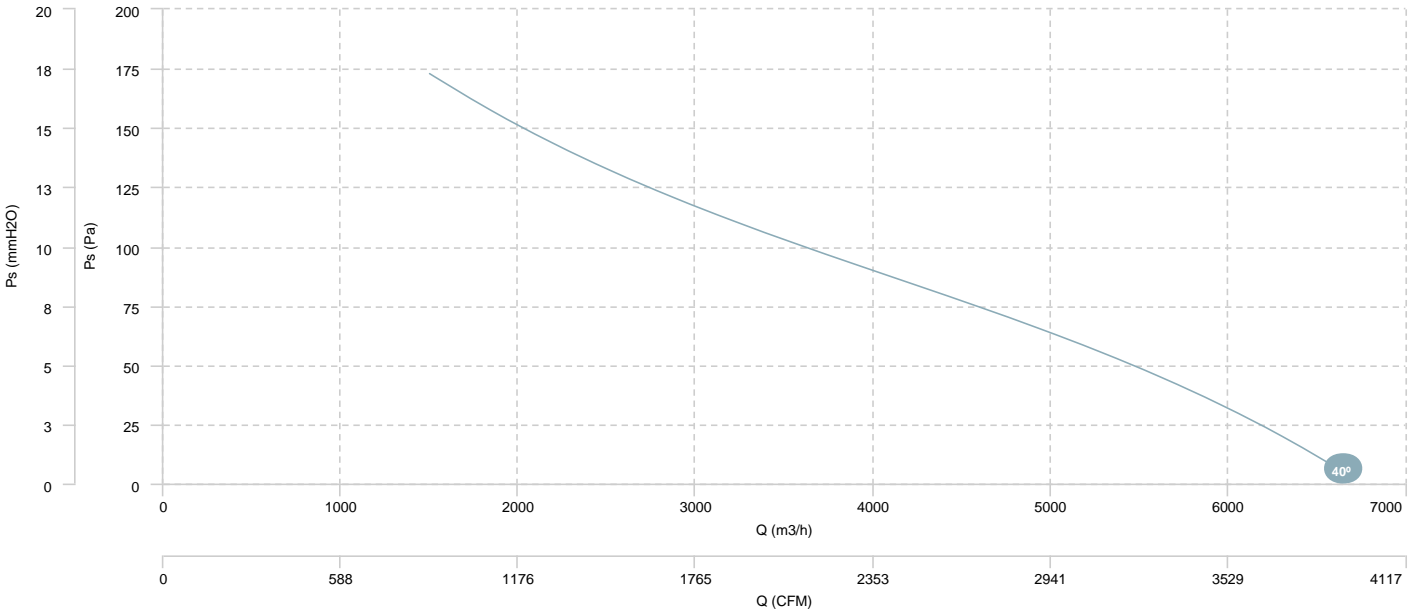

AIR FLOW - ABSORBED POWER

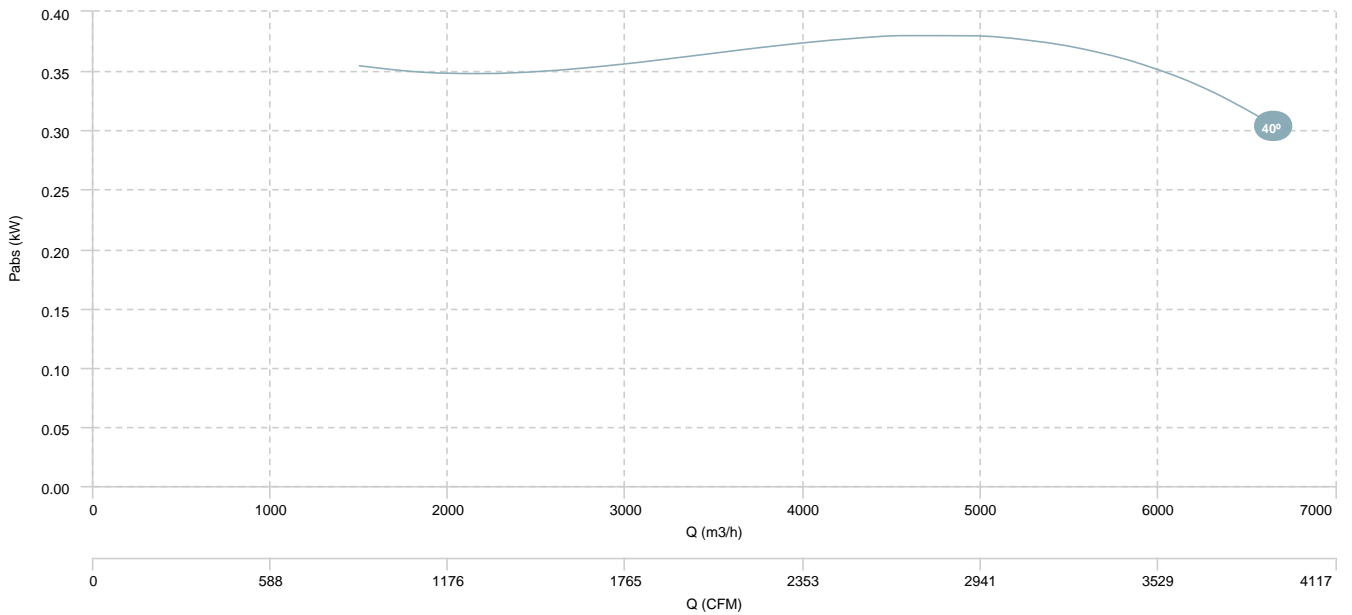

HBF 45 T4/T8 0,8/0,2kW (A5:6) F400

AIR FLOW - PRESSURE (4 poles)

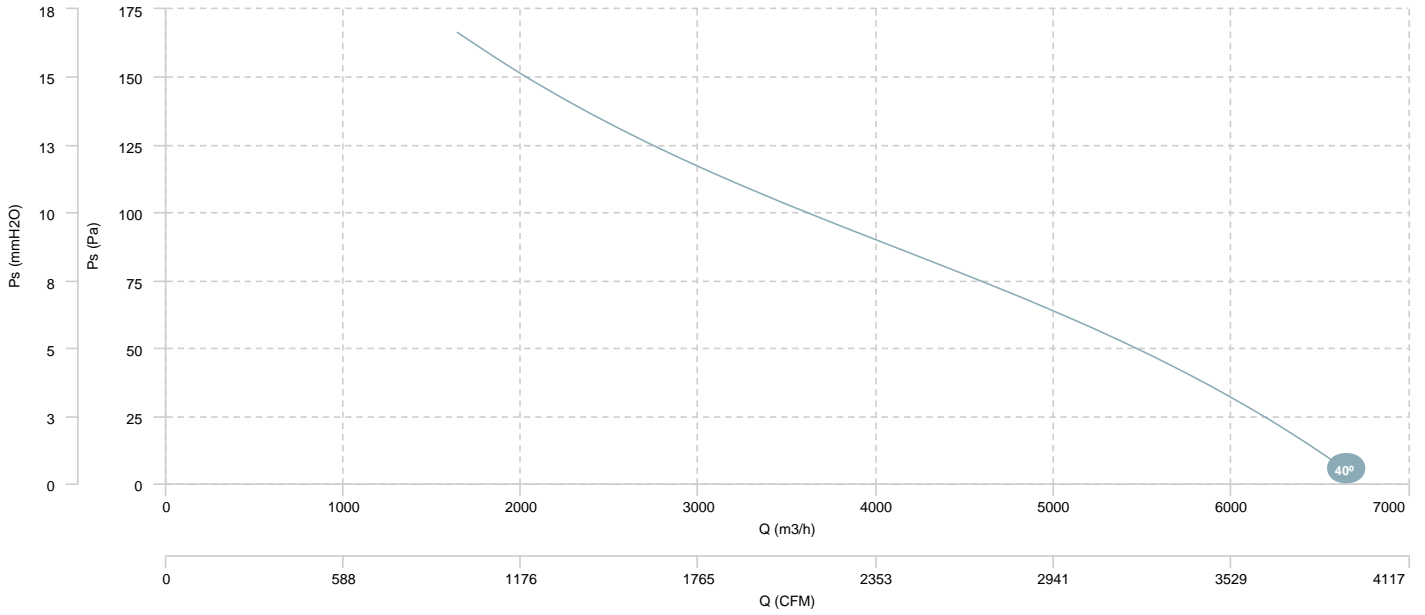

AIR FLOW - ABSORBED POWER (4 poles)

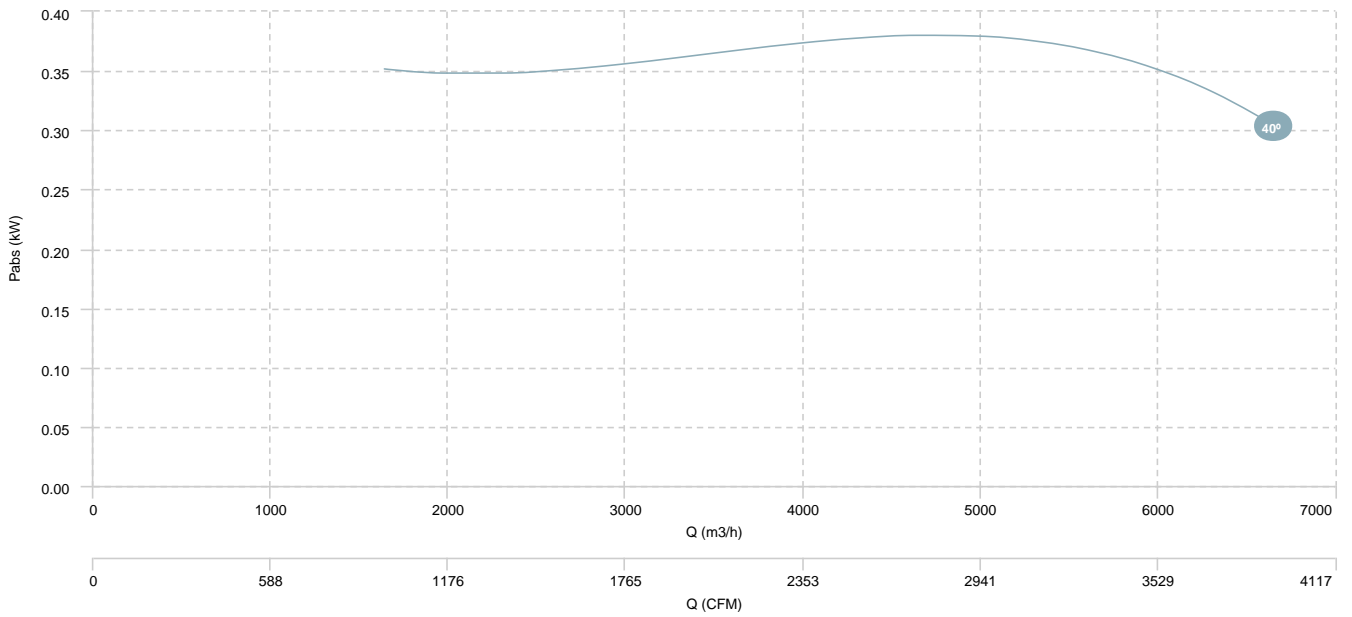

HBF 45 T4/T8 0,8/0,2kW (A5:6) F400

AIR FLOW - PRESSURE (8 poles)

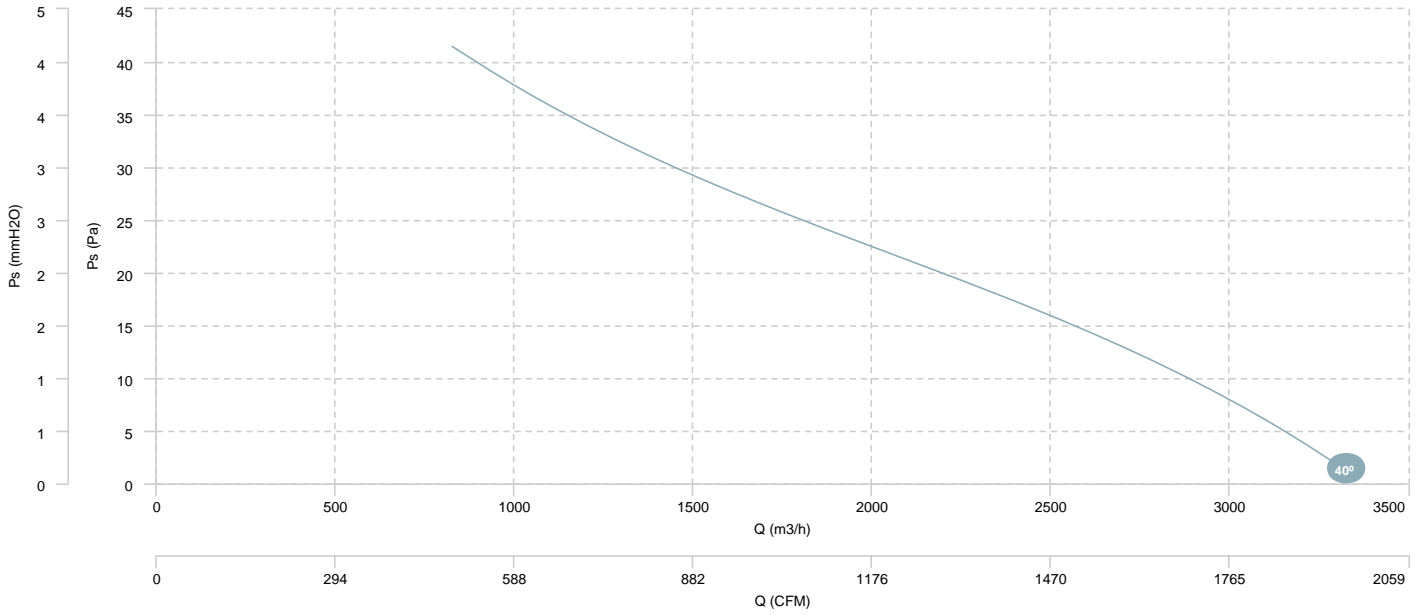

HBF 50 T4 0,75kW (A5:6) F400

AIR FLOW - PRESSURE

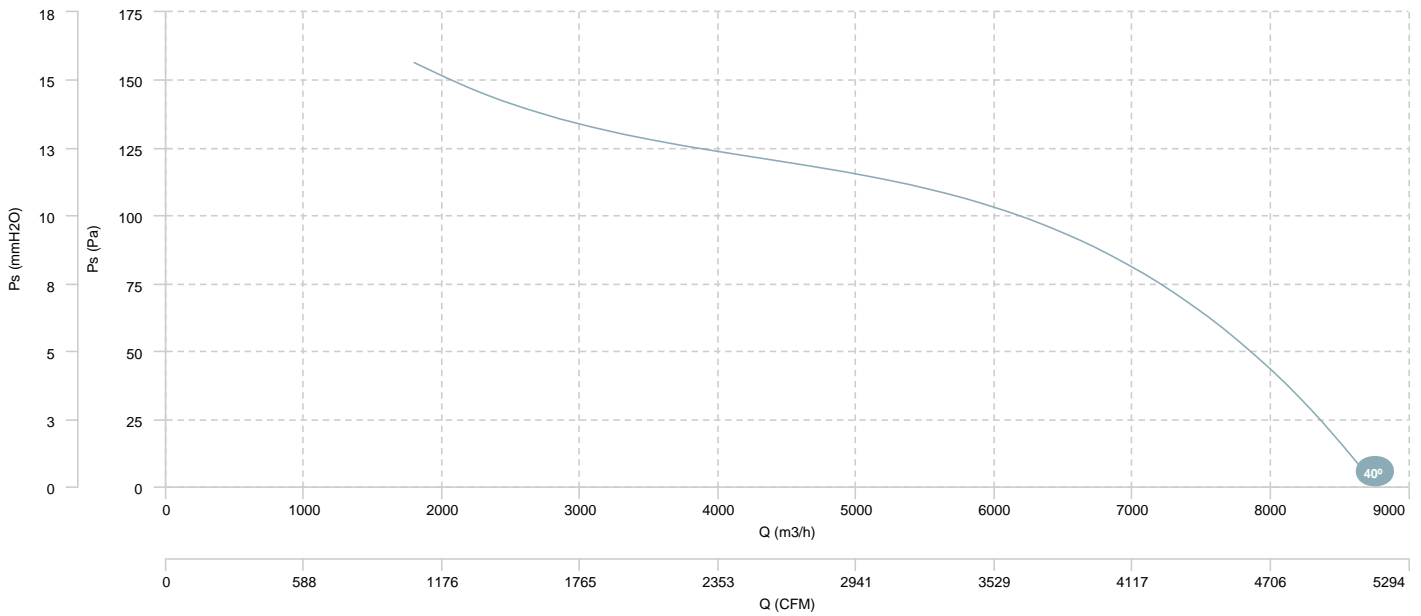

AIR FLOW - ABSORBED POWER

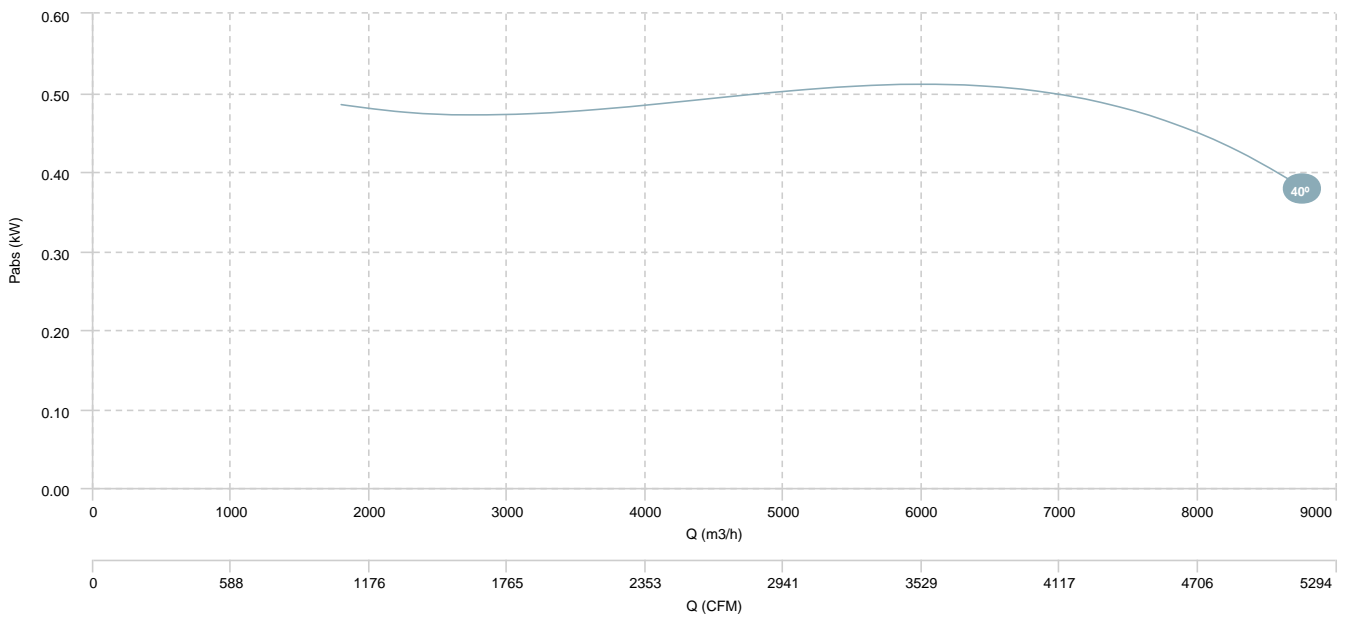

HBF 50 T6 0,75kW (A5:6) F400

AIR FLOW - PRESSURE

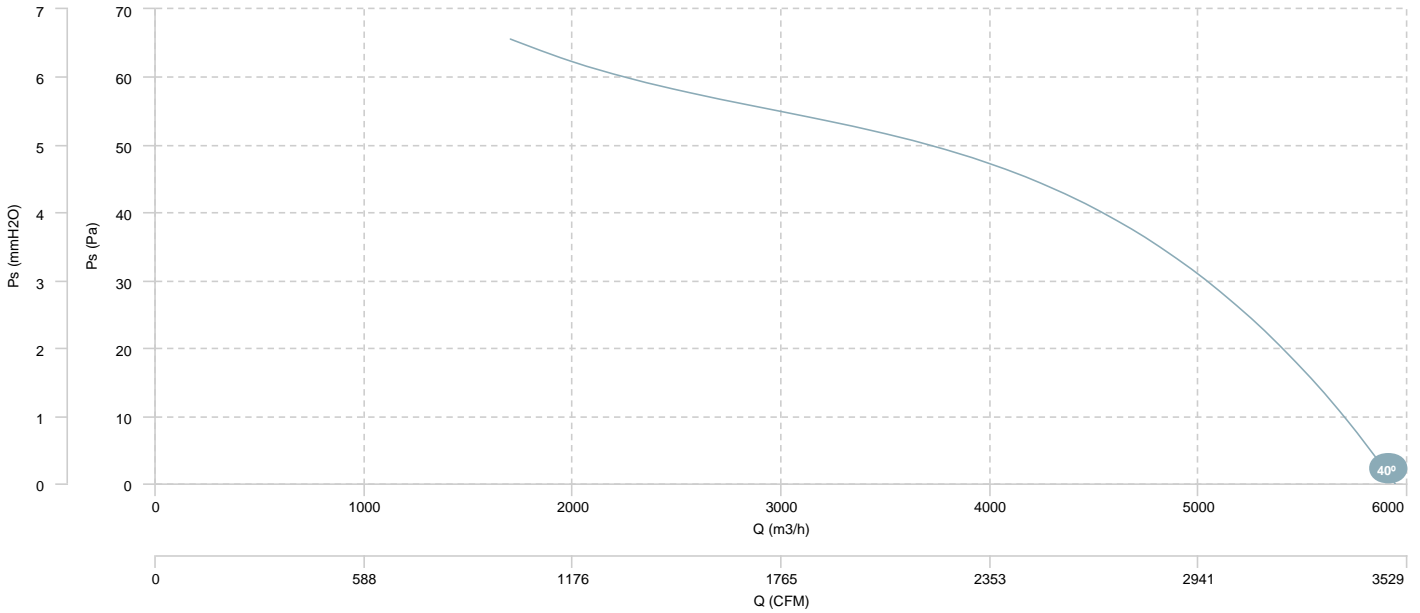

AIR FLOW - ABSORBED POWER

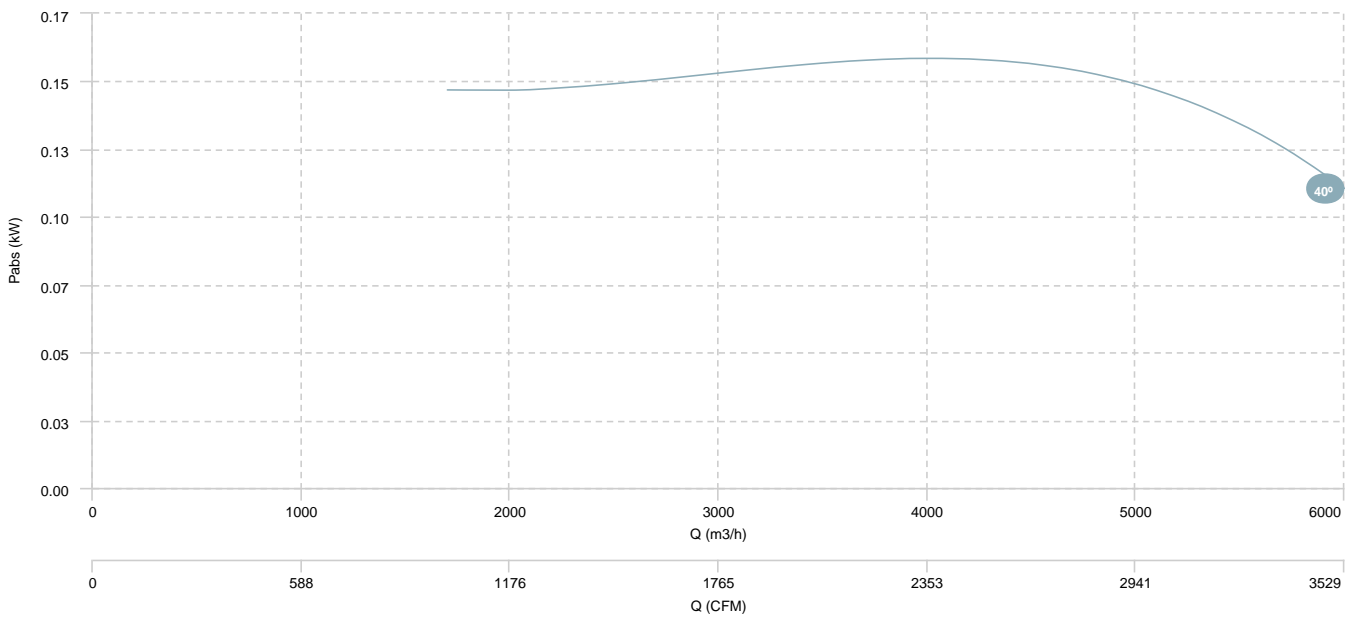

HBF 50 T4/T8 0,8/0,2kW (A5:6) F400

AIR FLOW - PRESSURE (4 poles)

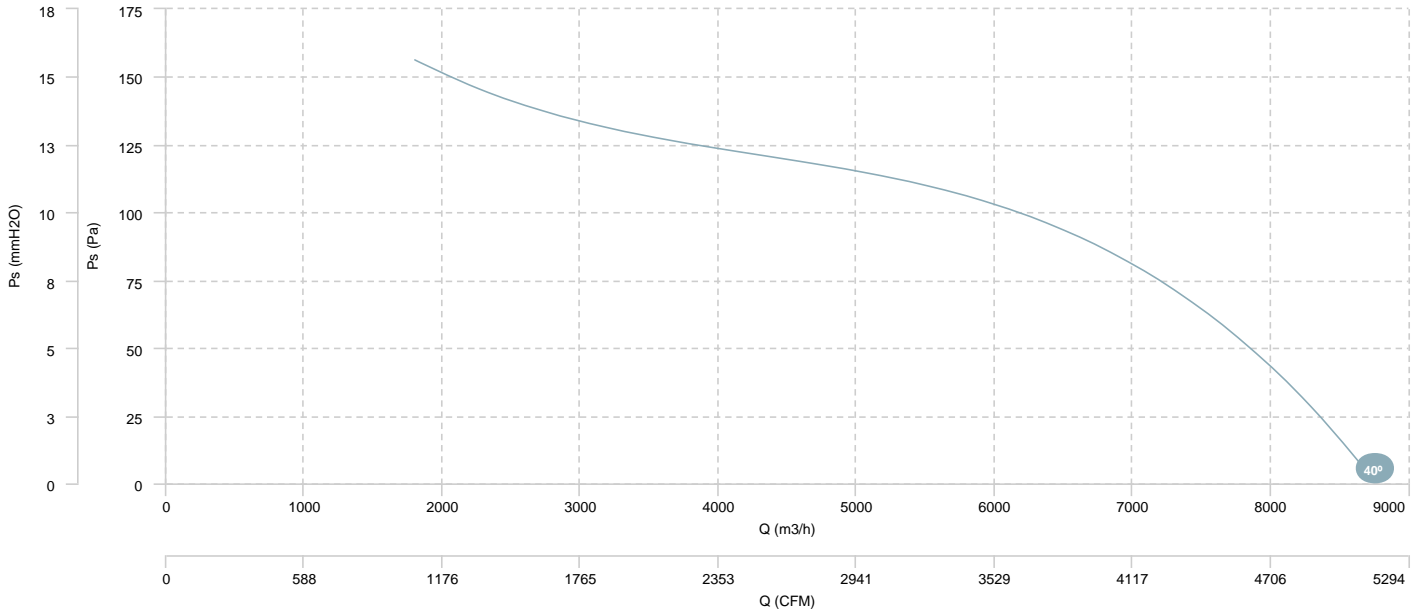

AIR FLOW - ABSORBED POWER (4 poles)

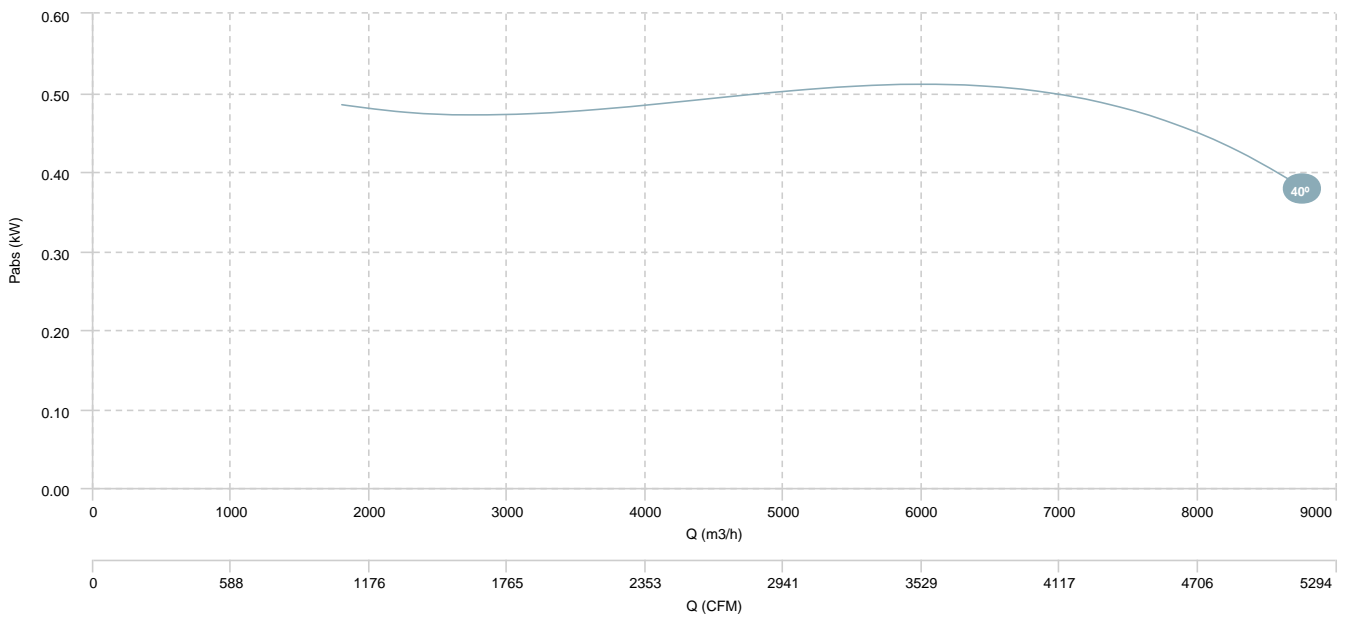

HBF 50 T4/T8 0,8/0,2kW (A5:6) F400

AIR FLOW - PRESSURE (8 poles)

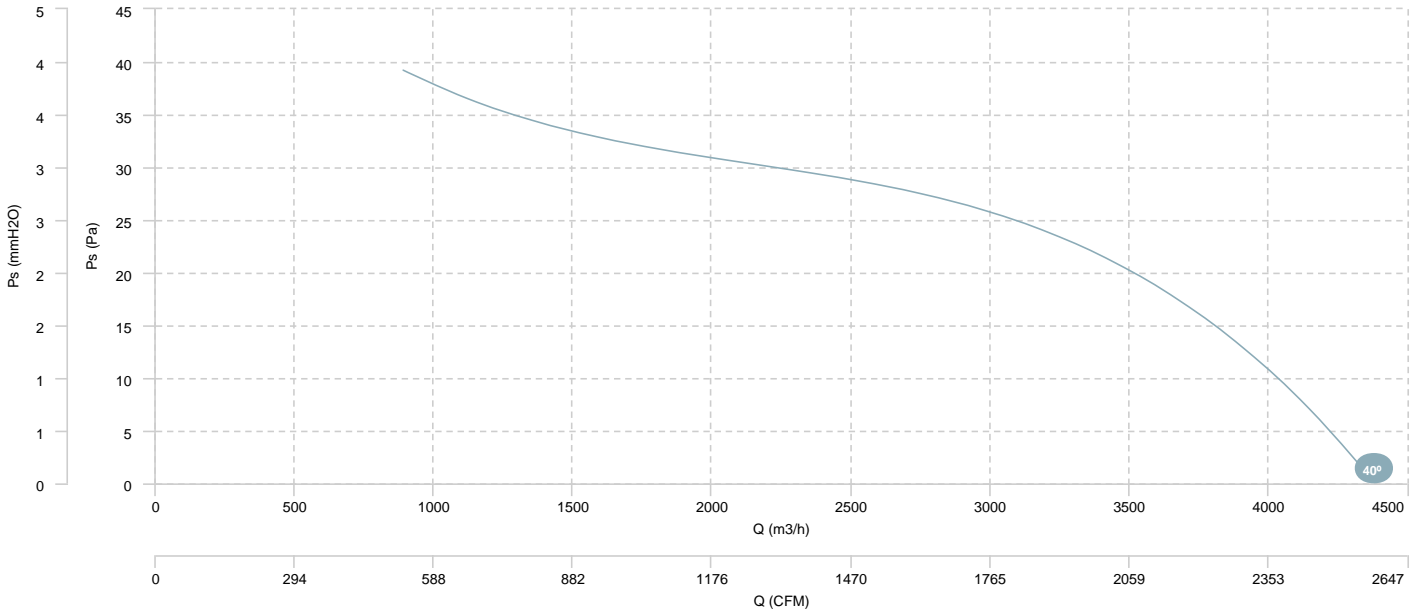

HBF 56 T4 0,75kW (A5:6) F400

HBF 56 T4 1,1kW (A5:6) F400

HBF 56 T4 1,5kW (A5:6) F400

AIR FLOW - PRESSURE

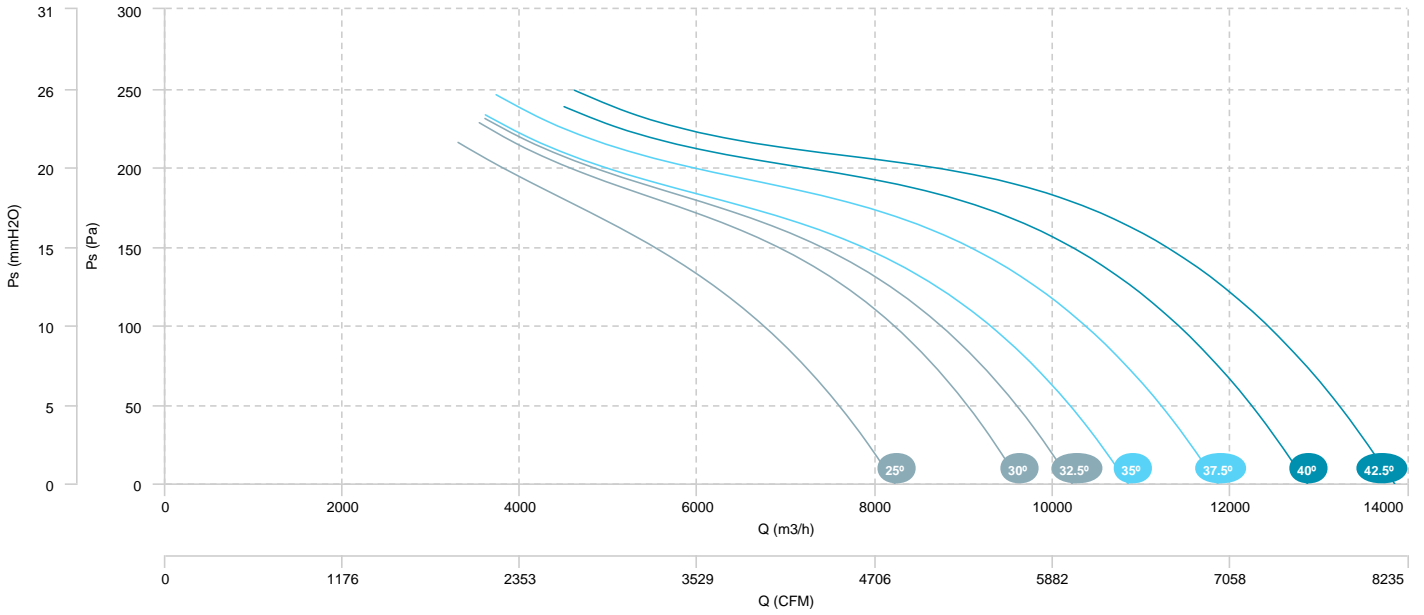

AIR FLOW - ABSORBED POWER

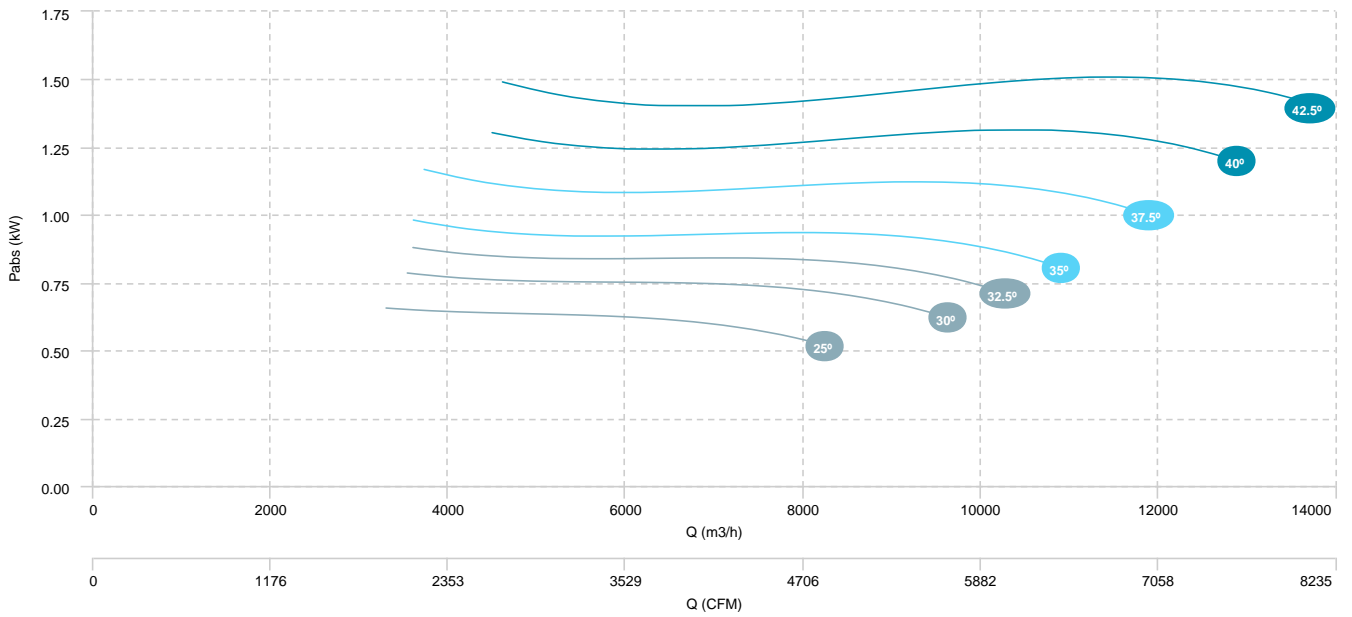

HBF 56 T6 0,75kW (A5:6) F400

AIR FLOW - PRESSURE

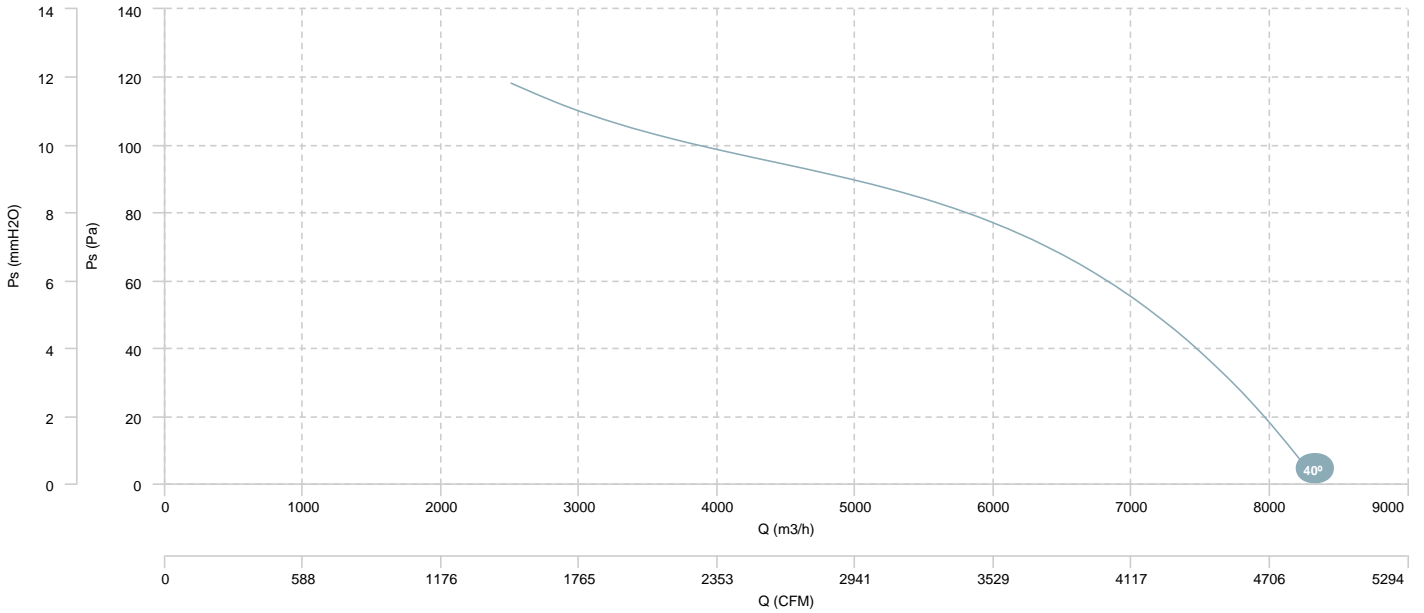

AIR FLOW - ABSORBED POWER

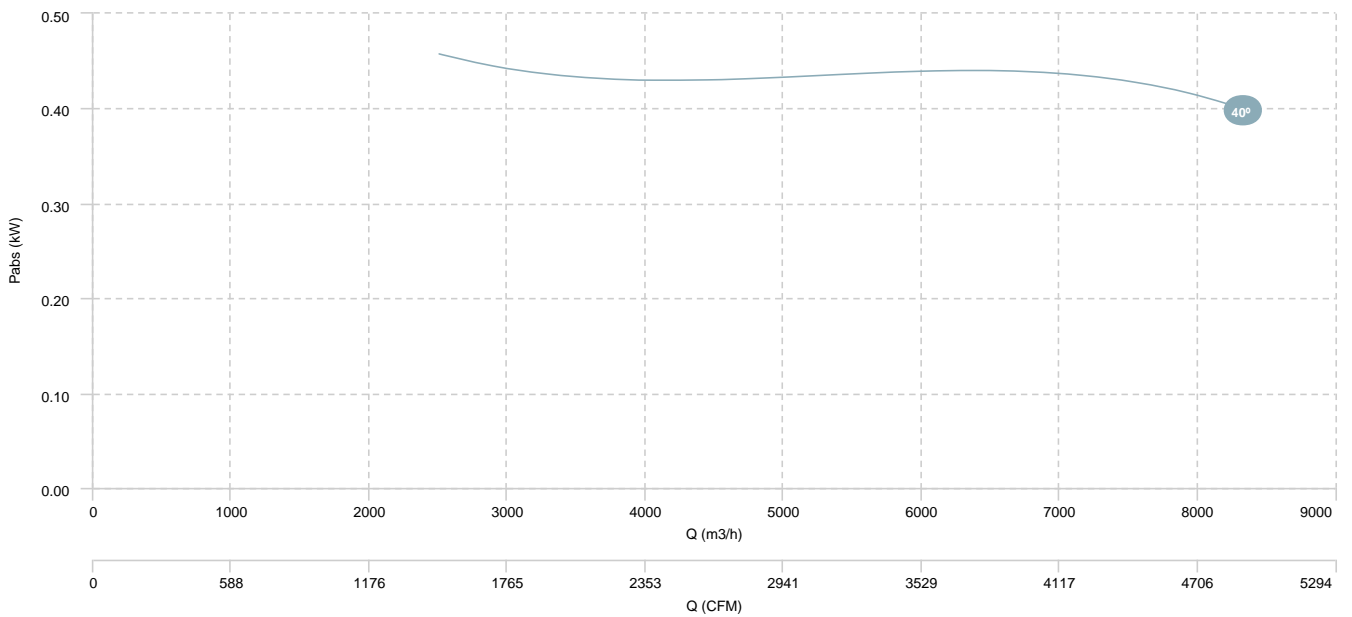

HBF 56 T4/T8 0,8/0,2kW (A5:6) F400

HBF 56 T4/T8 1,2/0,3kW (A5:6) F400

HBF 56 T4/T8 1,6/0,4kW (A5:6) F400

AIR FLOW - PRESSURE (4 poles)

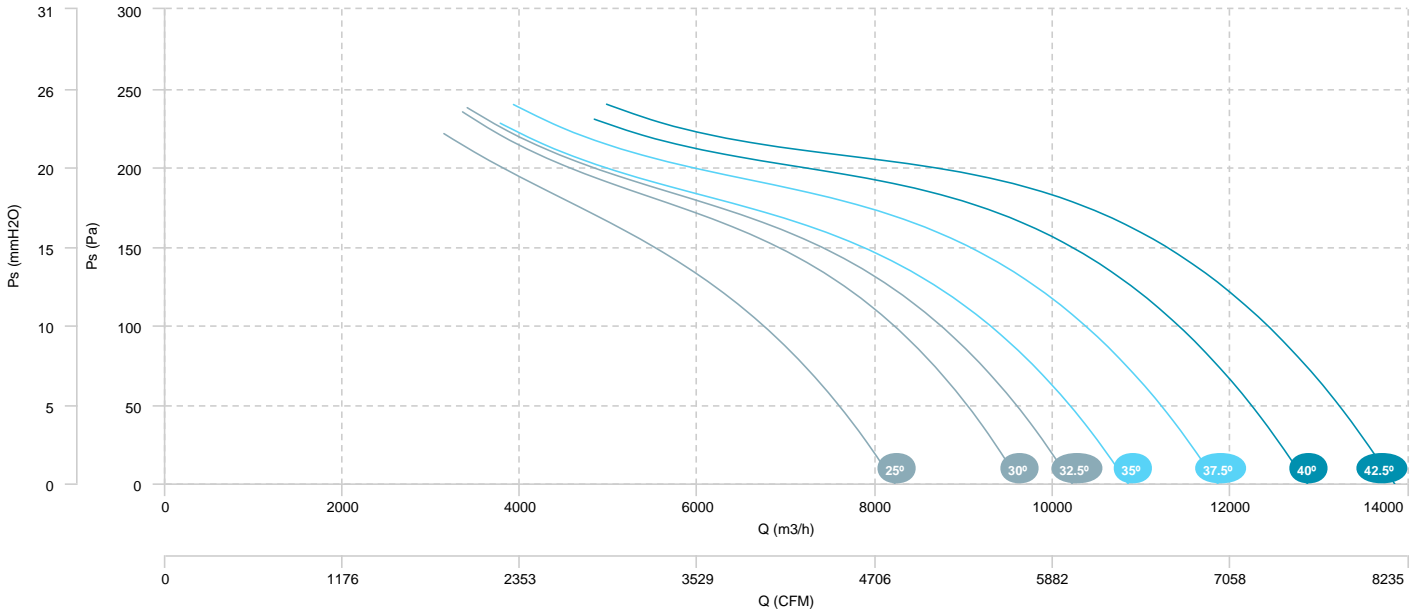

AIR FLOW - ABSORBED POWER (4 poles)

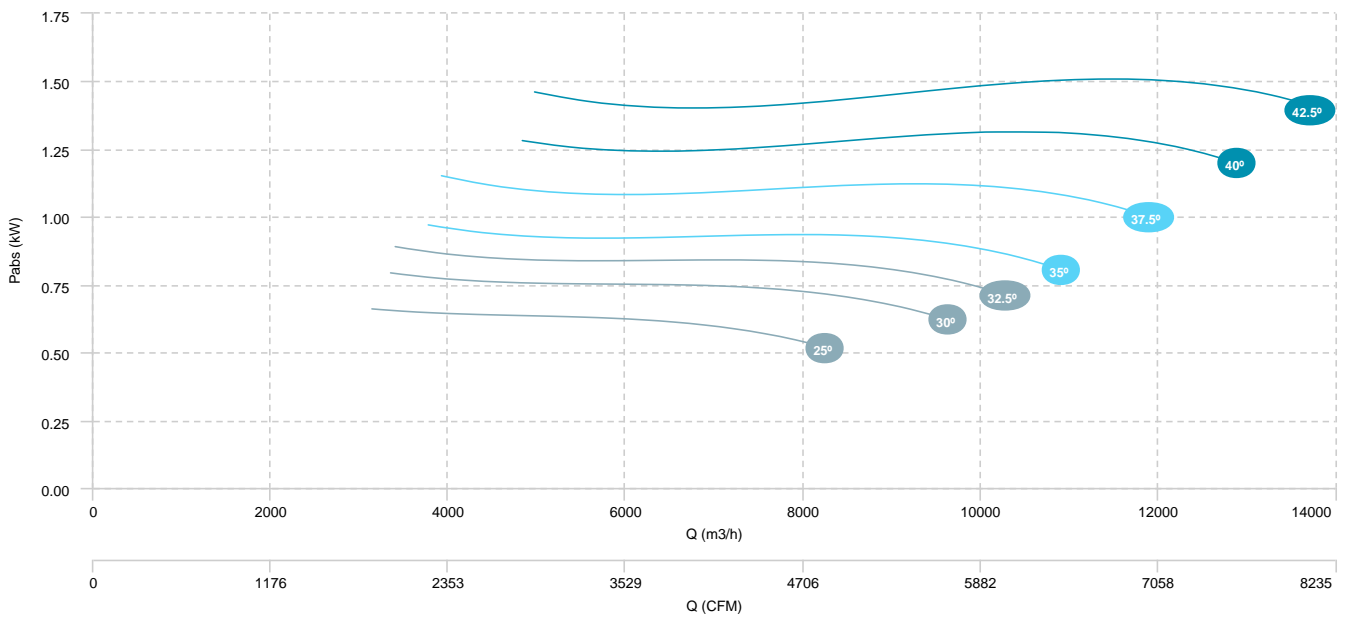

HBF 56 T4/T8 0,8/0,2kW (A5:6) F400

HBF 56 T4/T8 1,2/0,3kW (A5:6) F400

HBF 56 T4/T8 1,6/0,4kW (A5:6) F400

AIR FLOW - PRESSURE (8 poles)

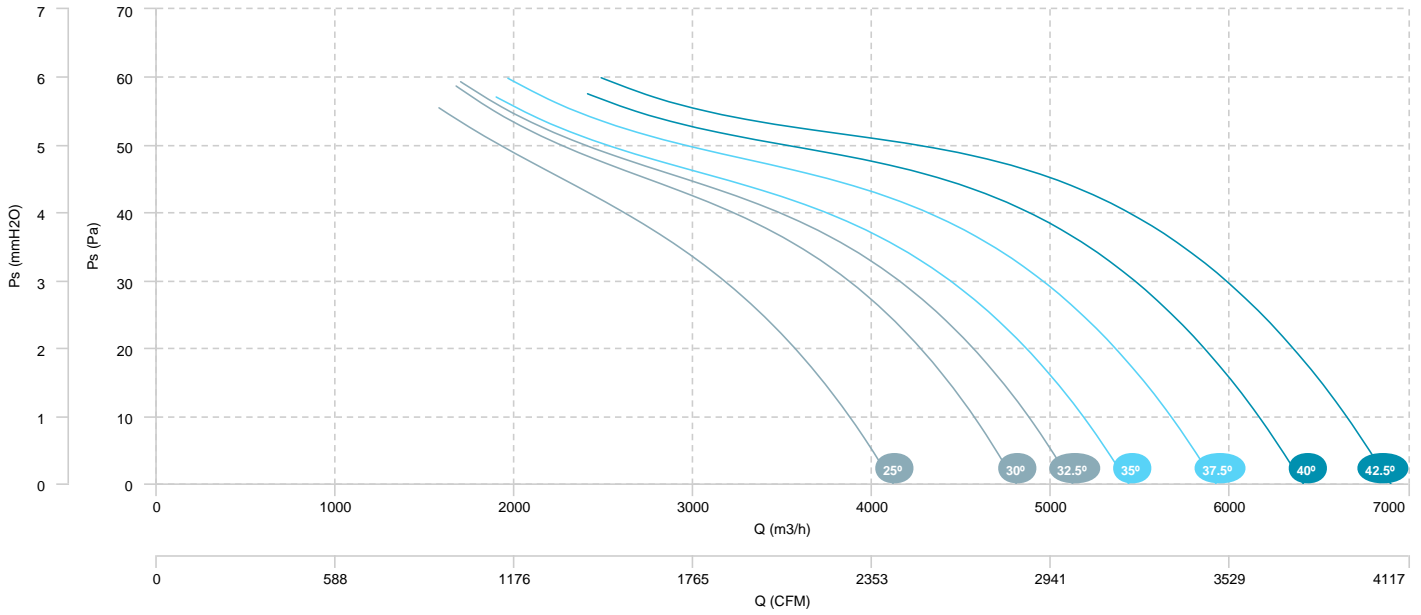

<p>■ HBF 63 T4 0,75kW (A5:6) F400</p> <p>■ HBF 63 T4 2,2kW (A5:6) F400</p>	<p>■ HBF 63 T4 1,1kW (A5:6) F400</p>	<p>■ HBF 63 T4 1,5kW (A5:6) F400</p>
--	--------------------------------------	--------------------------------------

AIR FLOW - PRESSURE

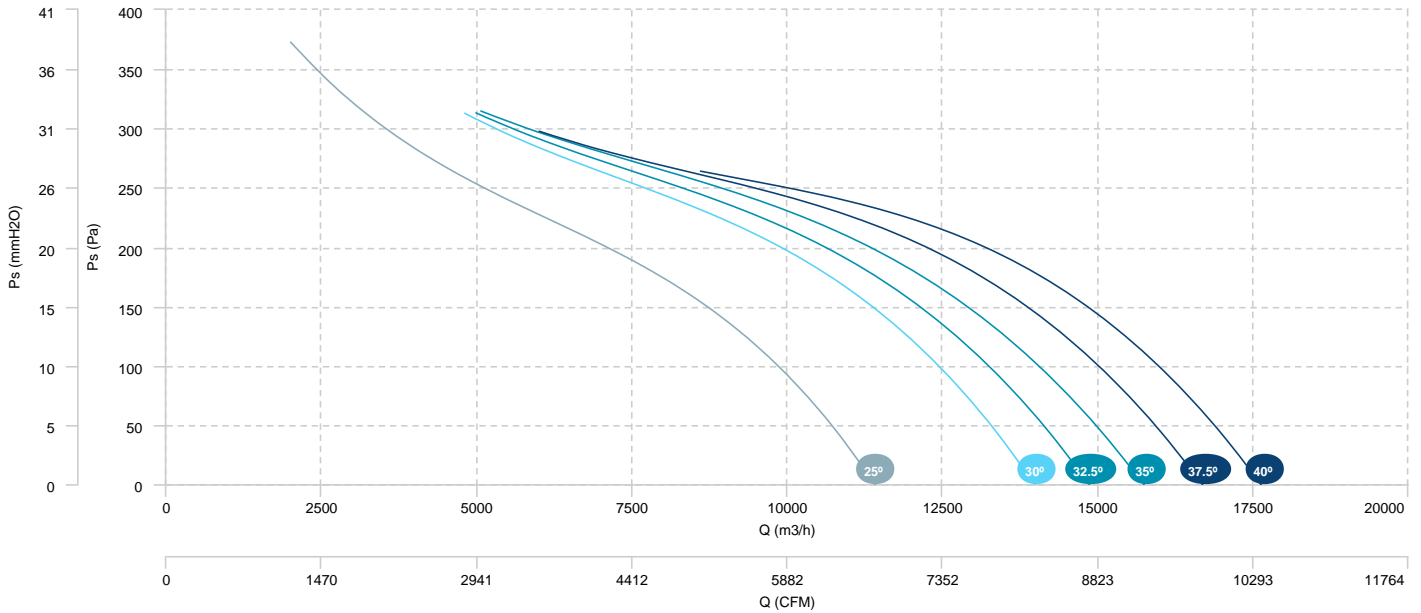

AIR FLOW - ABSORBED POWER

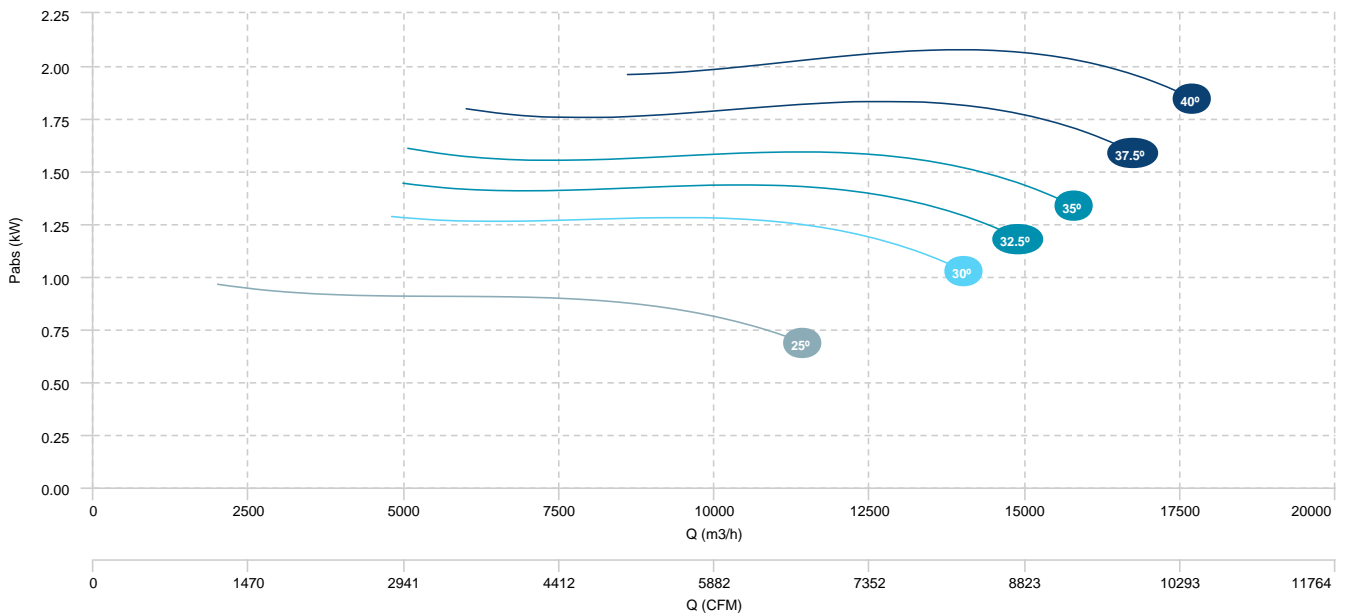

HBF 63 T6 0,75kW (A5:6) F400

AIR FLOW - PRESSURE

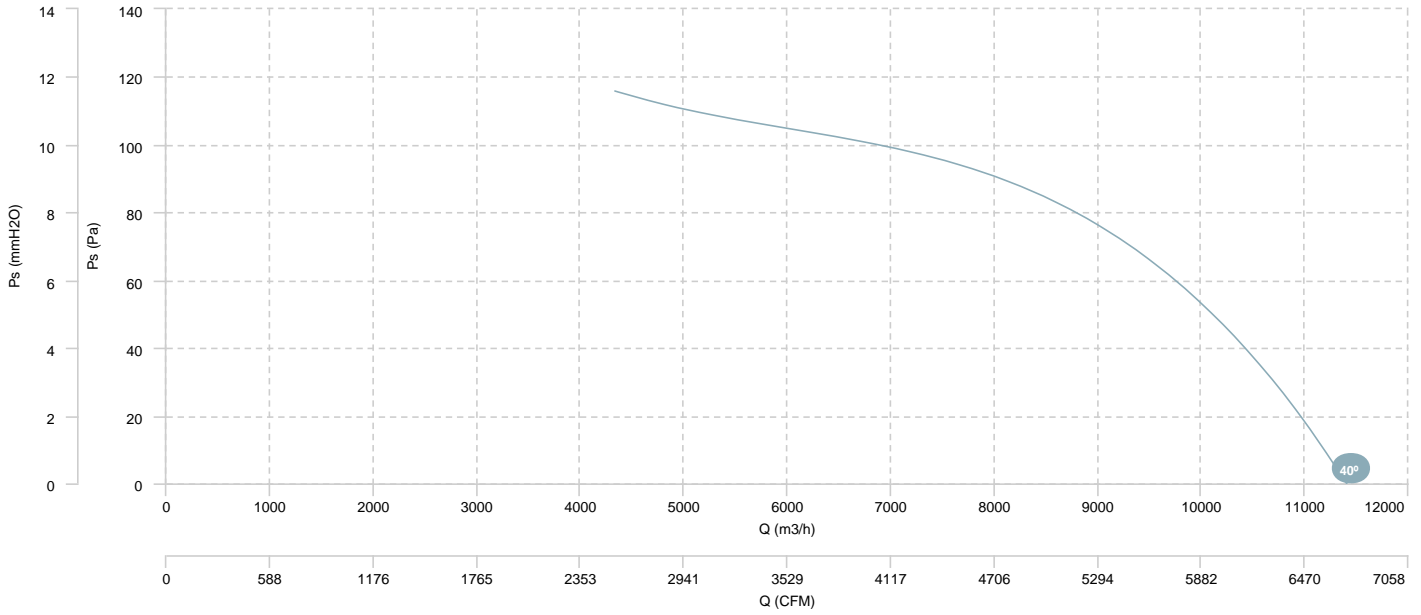

AIR FLOW - ABSORBED POWER

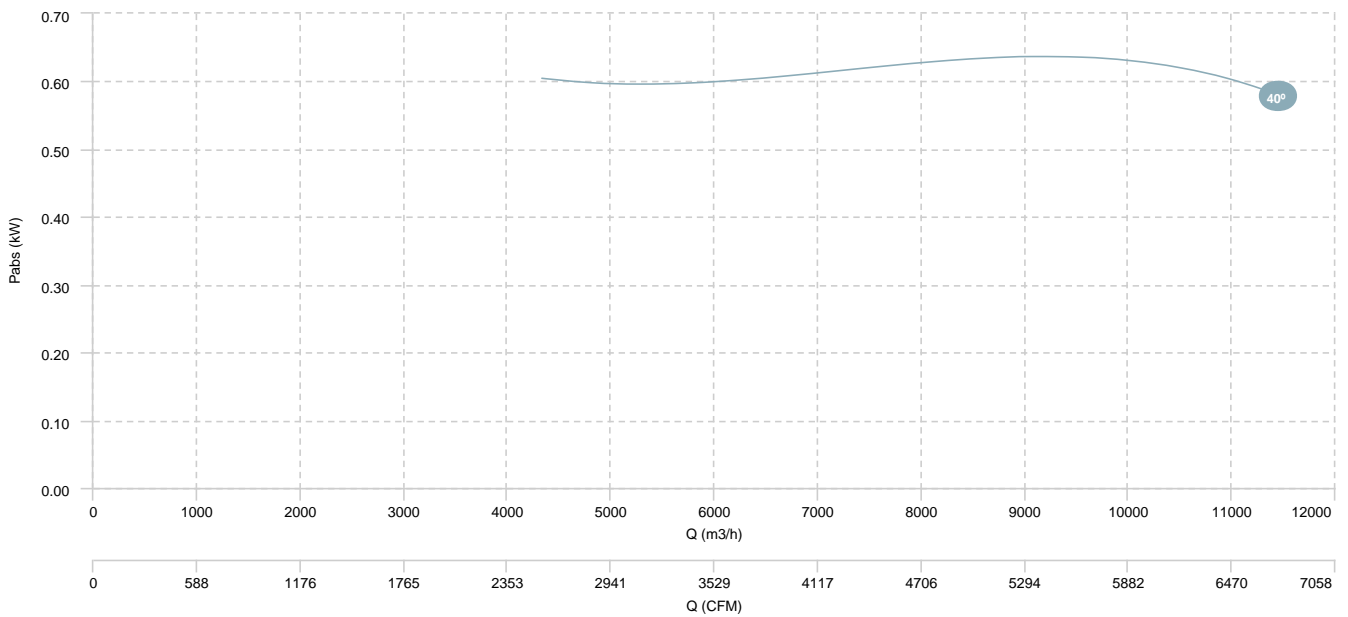

<p>HBF 63 T4/T8 0,8/0,2kW (A5:6) F400</p> <p>HBF 63 T4/T8 2,2/0,37kW (A5:6) F400</p>	<p>HBF 63 T4/T8 1,2/0,3kW (A5:6) F400</p>	<p>HBF 63 T4/T8 1,6/0,4kW (A5:6) F400</p>
--	---	---

AIR FLOW - PRESSURE (4 poles)

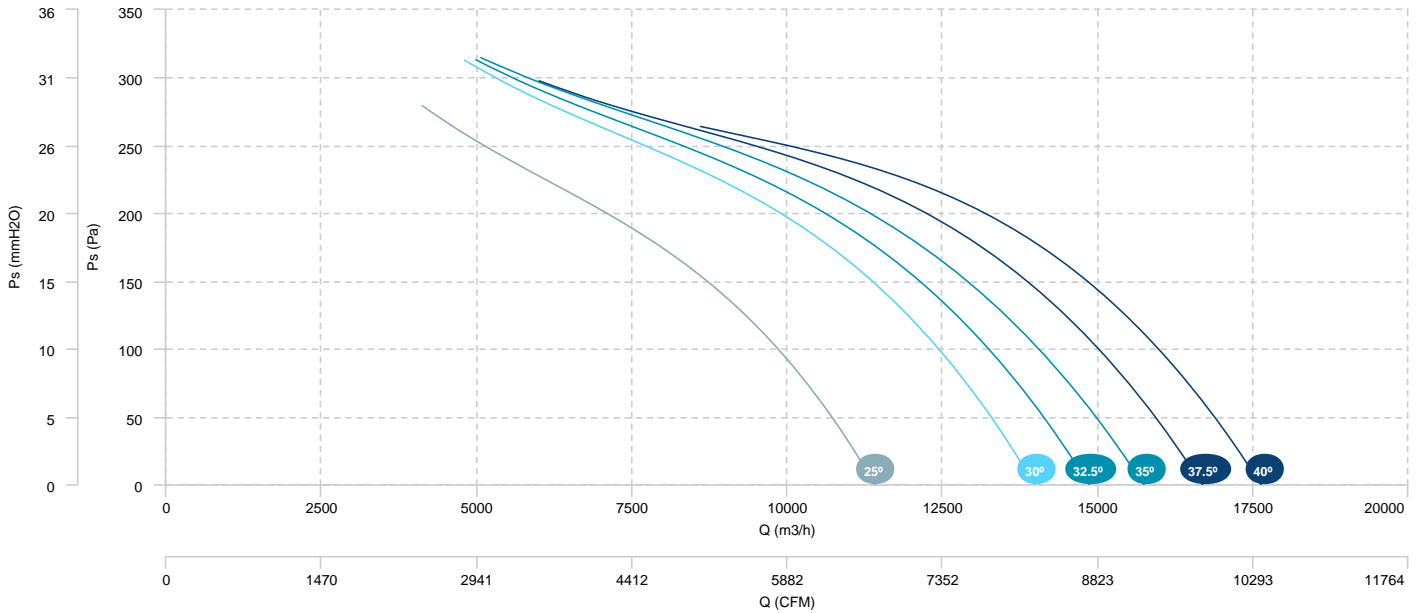

AIR FLOW - ABSORBED POWER (4 poles)

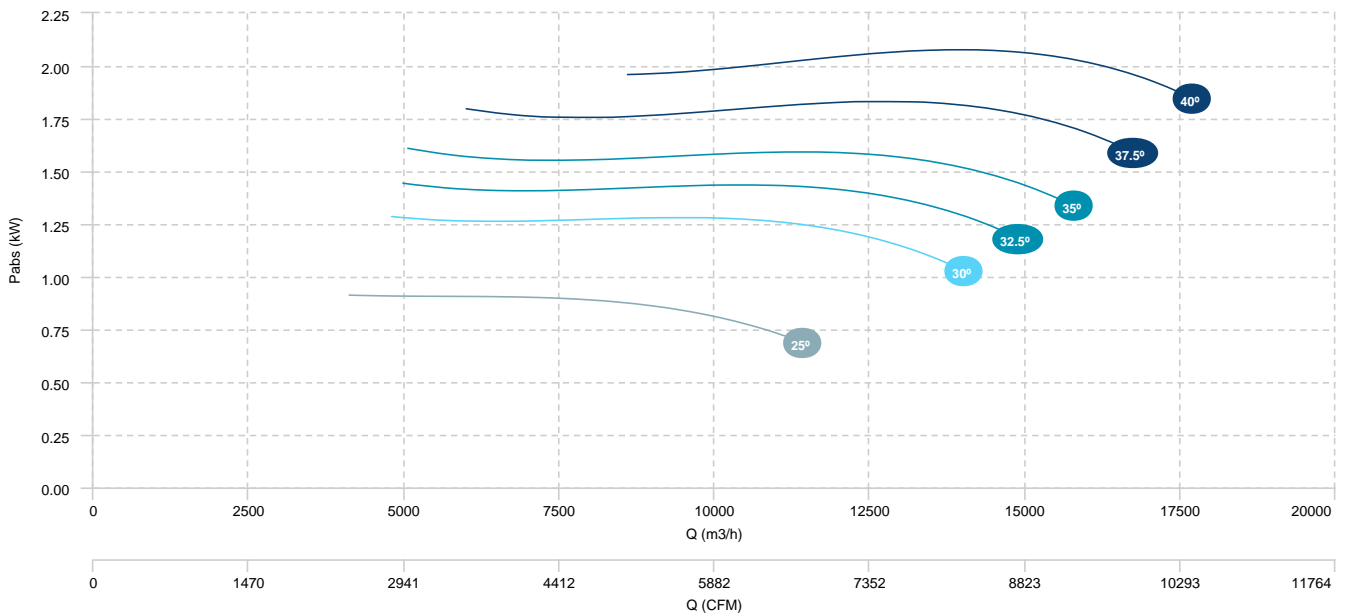

HBF 63 T4/T8 0,8/0,2kW (A5:6) F400

HBF 63 T4/T8 1,2/0,3kW (A5:6) F400

HBF 63 T4/T8 1,6/0,4kW (A5:6) F400

HBF 63 T4/T8 2,2/0,37kW (A5:6) F400

AIR FLOW - PRESSURE (8 poles)

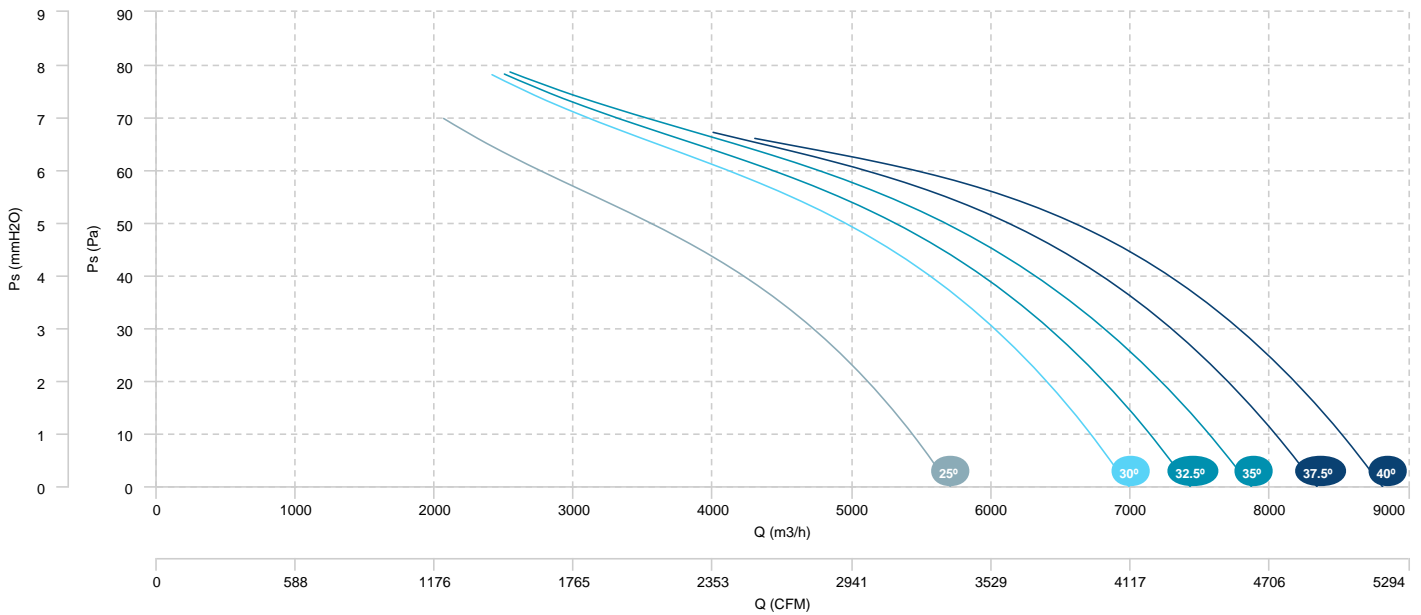

<p>HBF 71 T4 0,75kW (A5:6) F400</p> <p>HBF 71 T4 2,2kW (A5:6) F400</p>	<p>HBF 71 T4 1,1kW (A5:6) F400</p> <p>HBF 71 T4 3kW (A5:6) F400</p>	<p>HBF 71 T4 1,5kW (A5:6) F400</p>
--	---	------------------------------------

AIR FLOW - PRESSURE

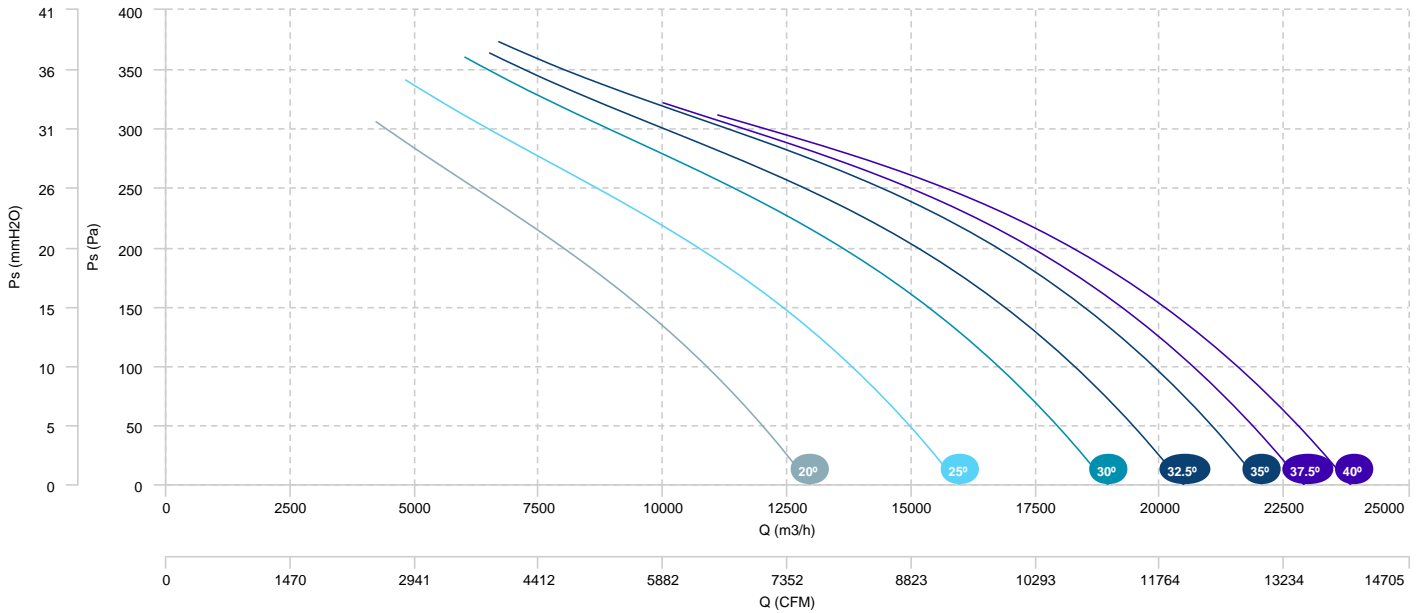

AIR FLOW - ABSORBED POWER

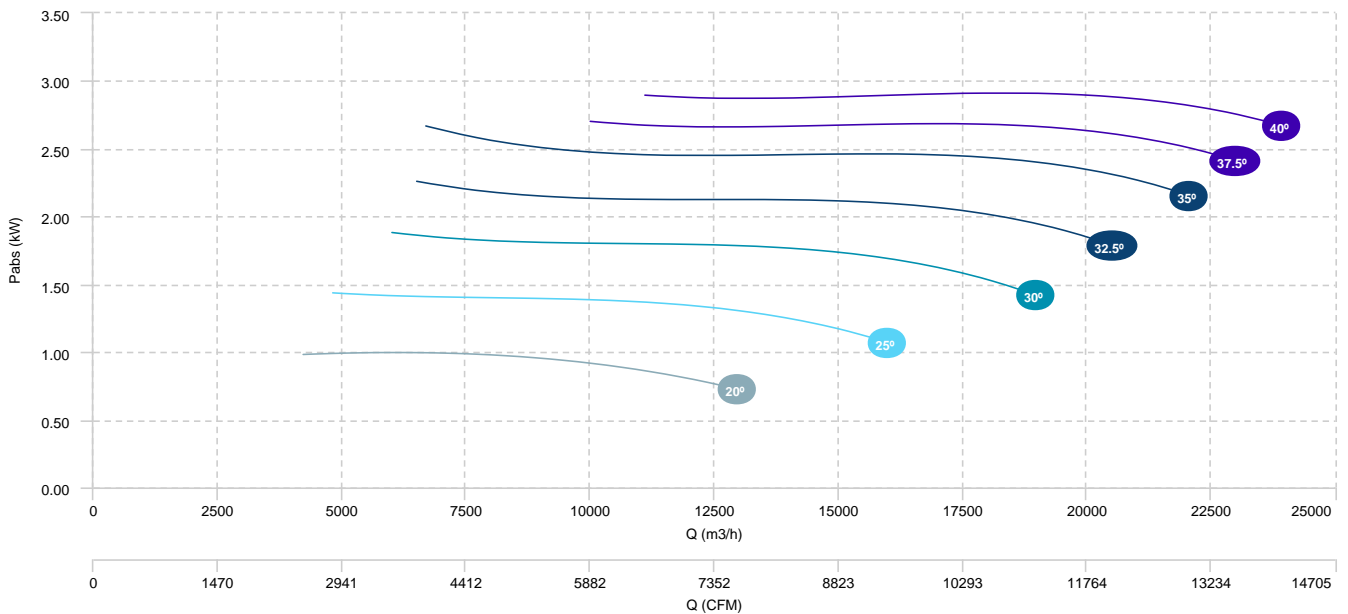

HBF 71 T6 0,75kW (A5:6) F400

AIR FLOW - PRESSURE

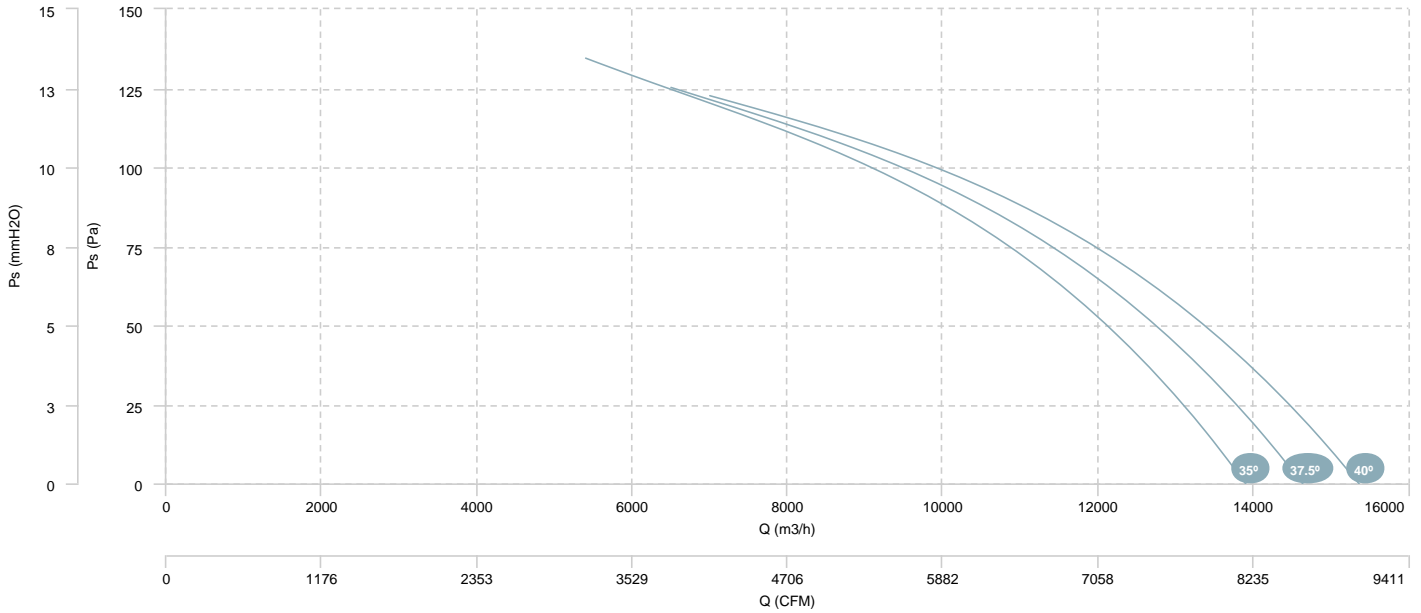

AIR FLOW - ABSORBED POWER

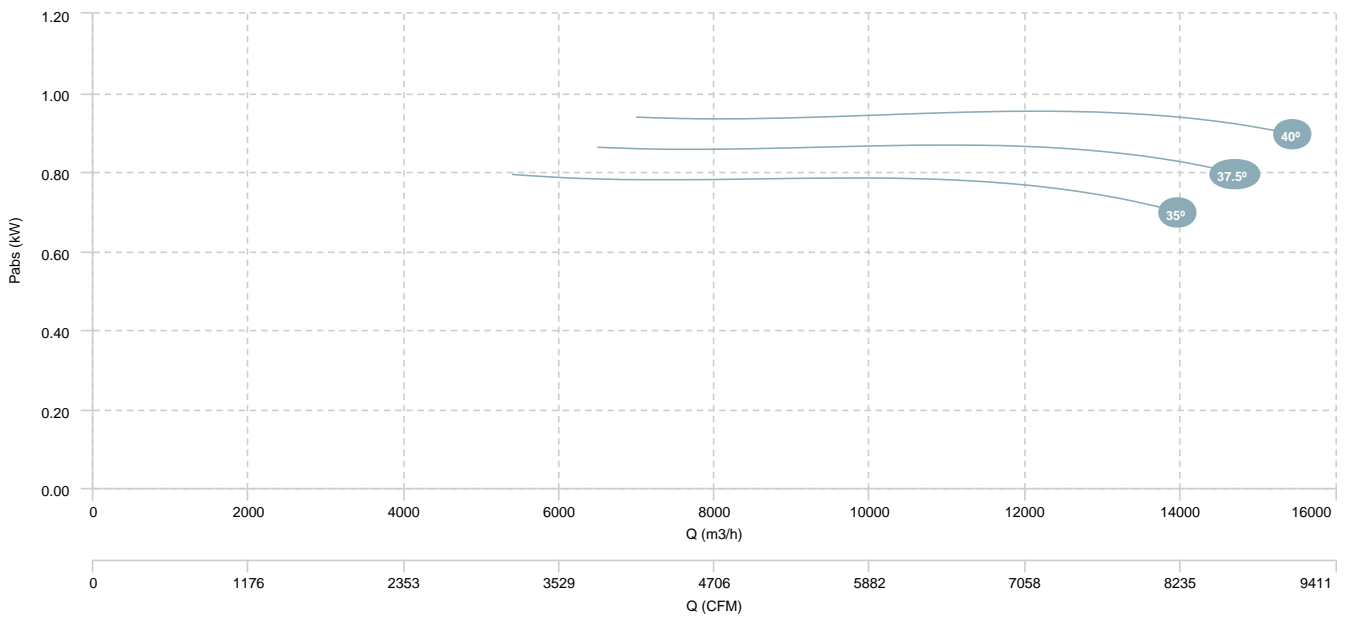

<p>HBF 71 T4/T8 0,8/0,2kW (A5:6) F400</p> <p>HBF 71 T4/T8 2,2/0,37kW (A5:6) F400</p>	<p>HBF 71 T4/T8 1,2/0,3kW (A5:6) F400</p> <p>HBF 71 T4/T8 3/0,55kW (A5:6) F400</p>	<p>HBF 71 T4/T8 1,6/0,4kW (A5:6) F400</p>
--	--	---

AIR FLOW - PRESSURE (4 poles)

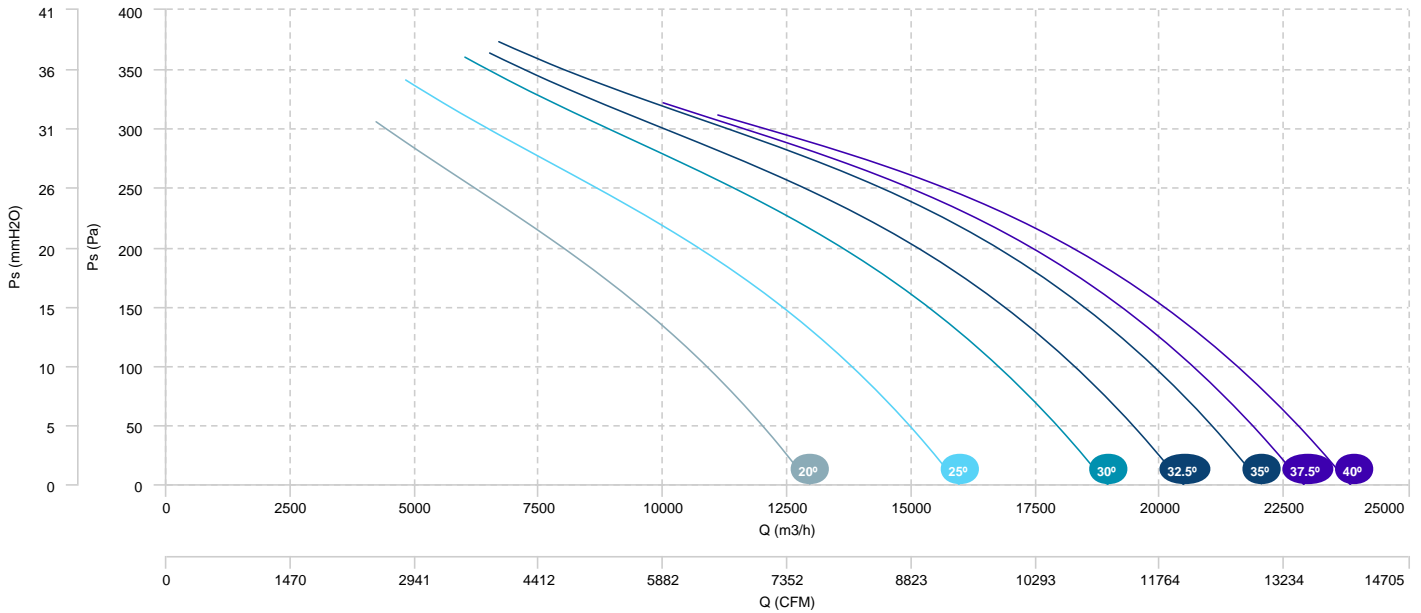

AIR FLOW - ABSORBED POWER (4 poles)

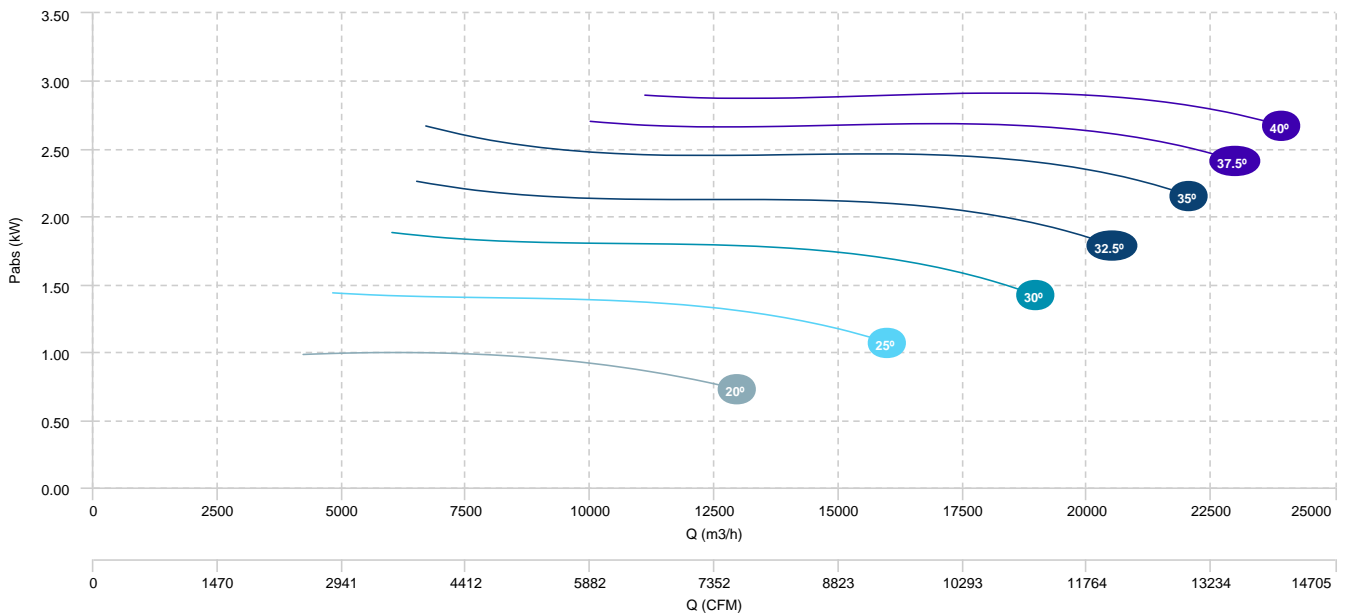

<p>HBF 71 T4/T8 0,8/0,2kW (A5:6) F400</p> <p>HBF 71 T4/T8 2,2/0,37kW (A5:6) F400</p>	<p>HBF 71 T4/T8 1,2/0,3kW (A5:6) F400</p> <p>HBF 71 T4/T8 3/0,55kW (A5:6) F400</p>	<p>HBF 71 T4/T8 1,6/0,4kW (A5:6) F400</p>
--	--	---

AIR FLOW - PRESSURE (8 poles)

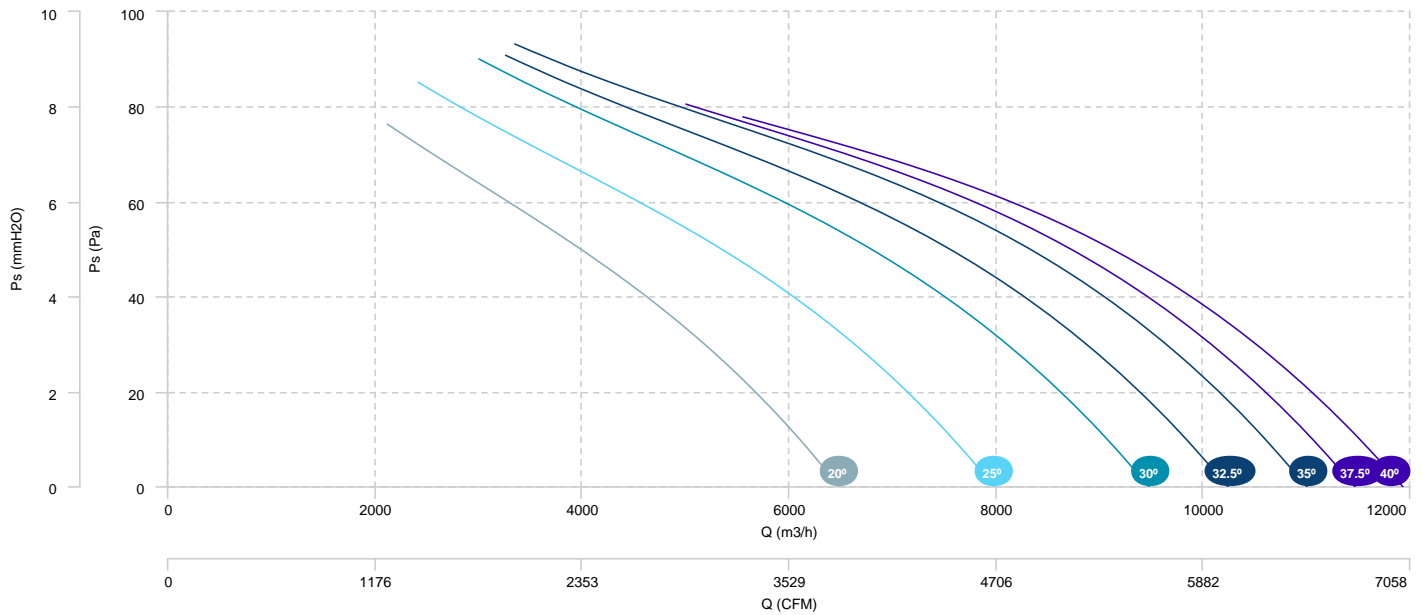

HBF 80 T4 3kW (A5:6) F400

HBF 80 T4 4kW (A5:6) F400

AIR FLOW - PRESSURE

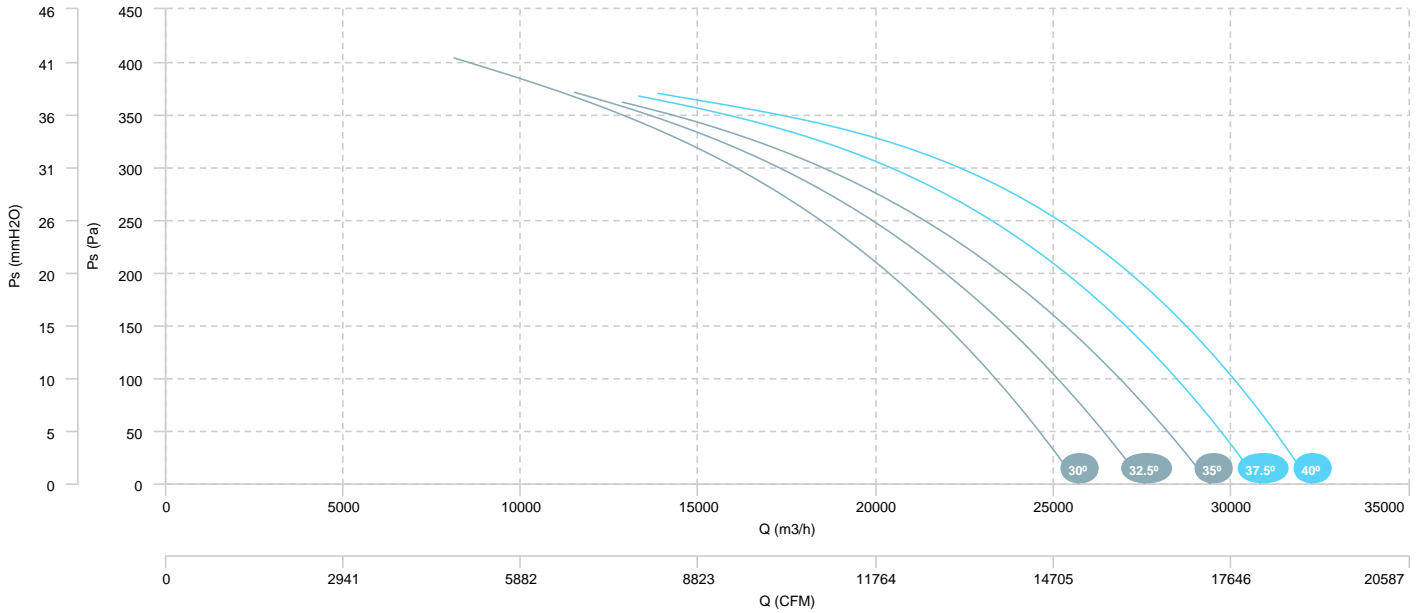

AIR FLOW - ABSORBED POWER

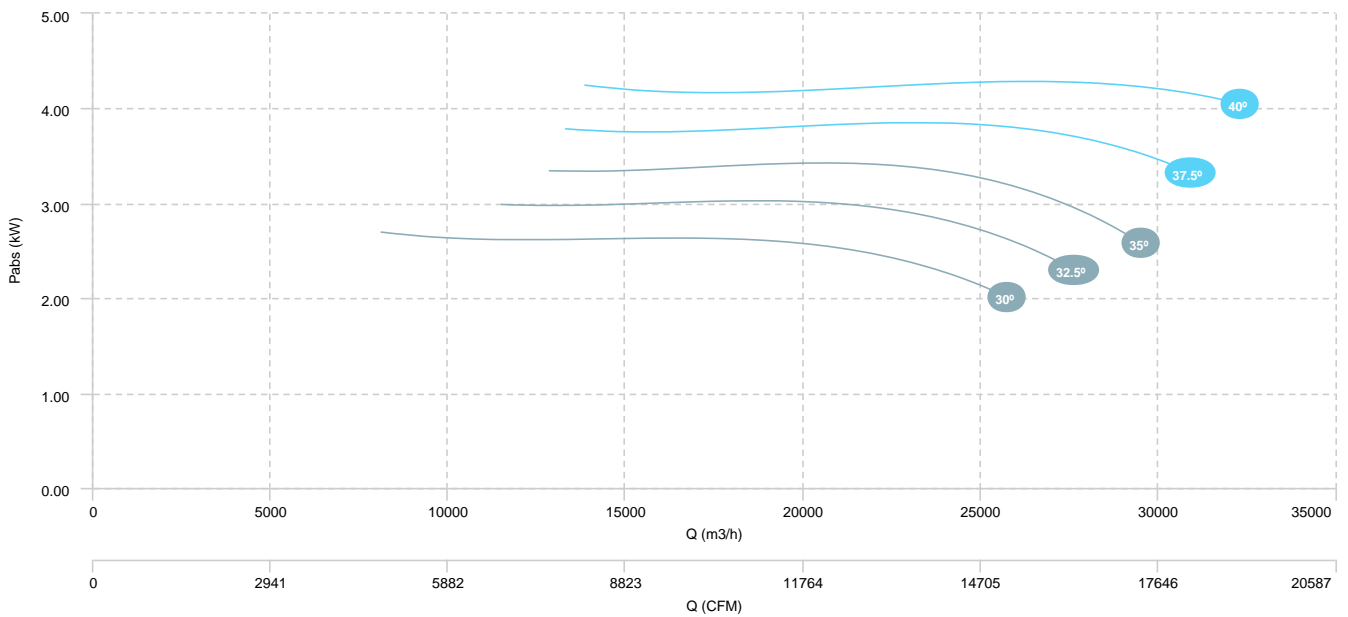

HBF 80 T6 0,75kW (A5:6) F400
HBF 80 T6 2,2kW (A5:6) F400

HBF 80 T6 1,1kW (A5:6) F400

HBF 80 T6 1,5kW (A5:6) F400

AIR FLOW - PRESSURE

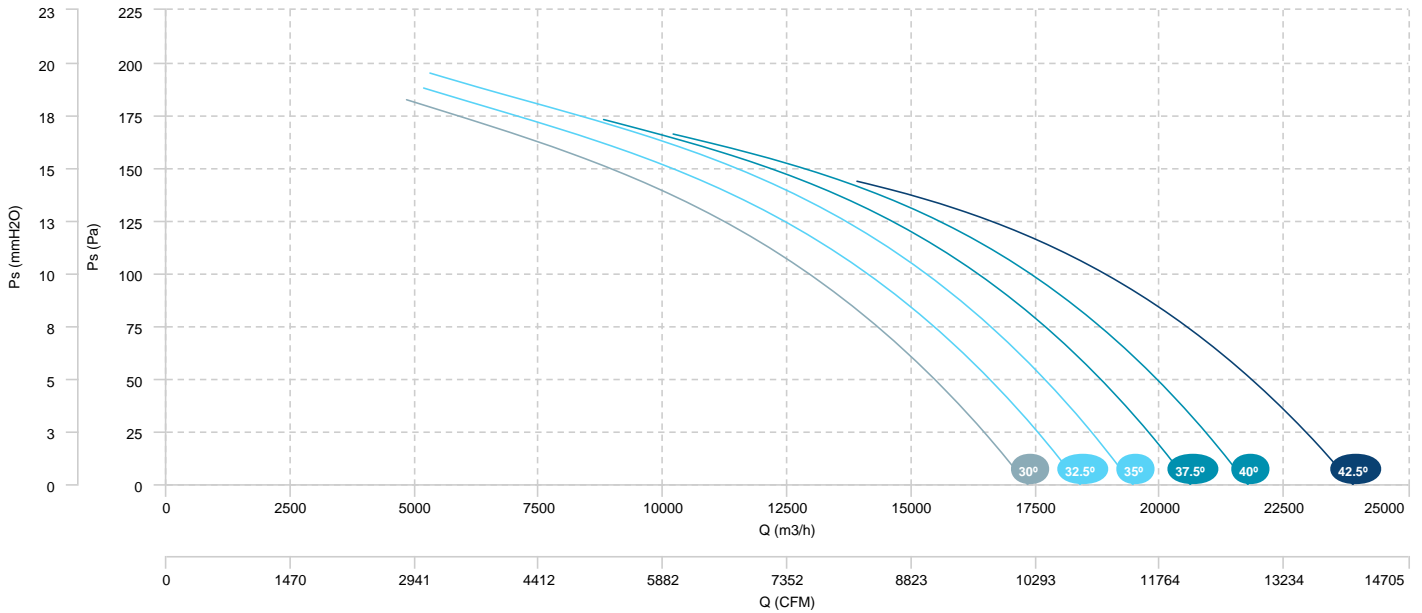

AIR FLOW - ABSORBED POWER

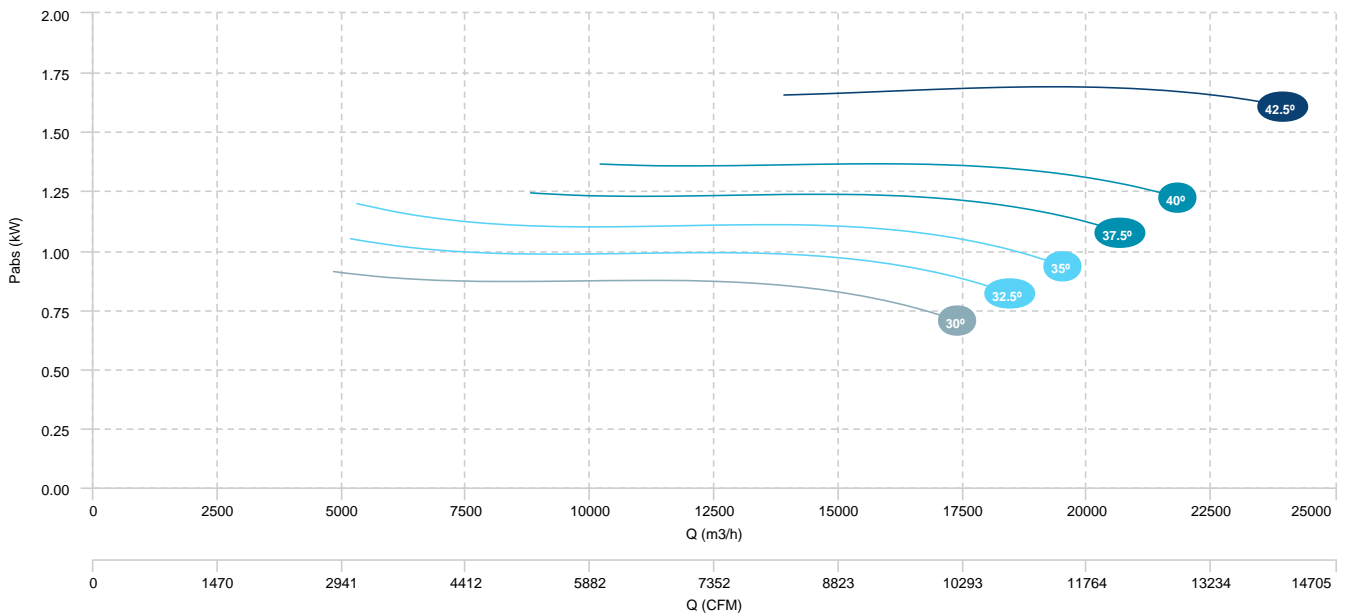

HBF 80 T4/T8 3/0,55kW (A5:6) F400

HBF 80 T4/T8 4/0,75kW (A5:6) F400

AIR FLOW - PRESSURE (4 poles)

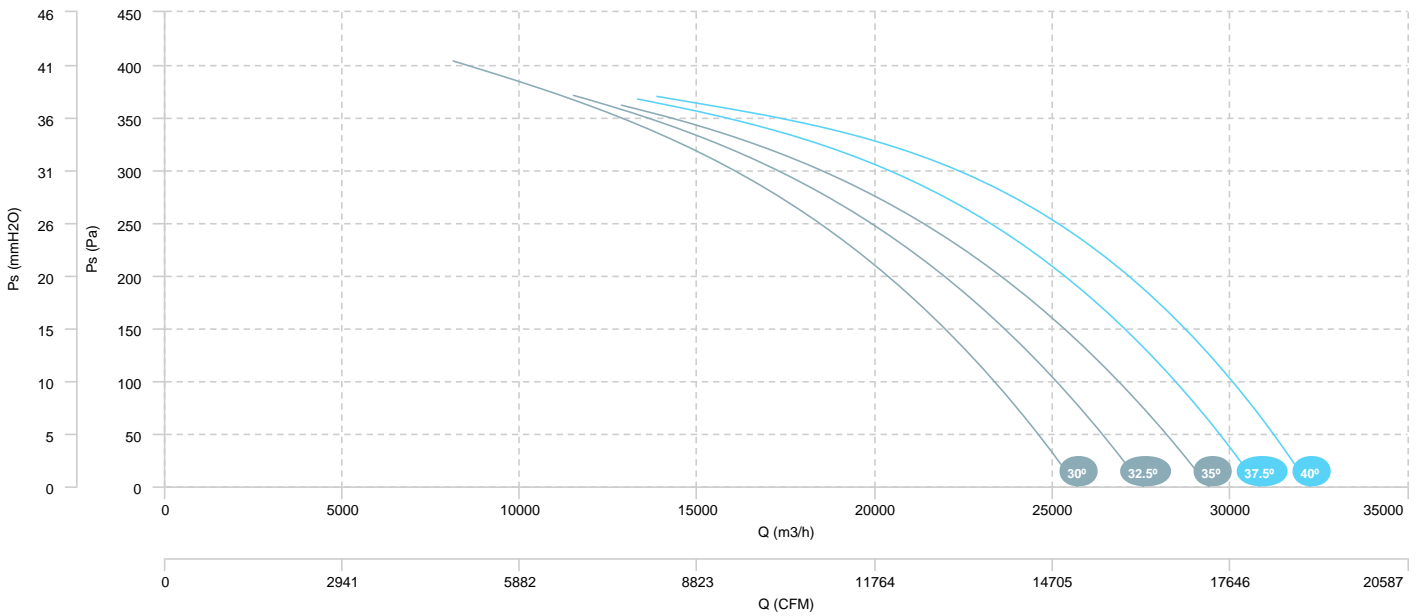

AIR FLOW - ABSORBED POWER (4 poles)

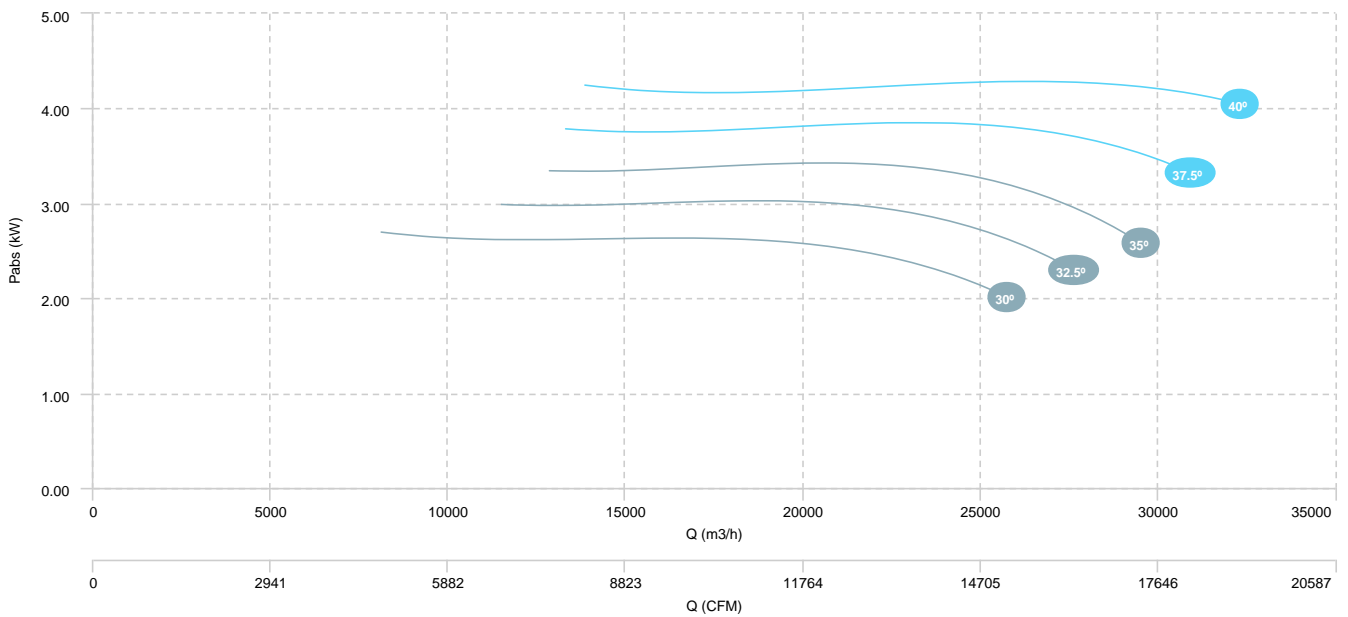

HBF 80 T4/T8 3/0,55kW (A5:6) F400

HBF 80 T4/T8 4/0,75kW (A5:6) F400

AIR FLOW - PRESSURE (8 poles)

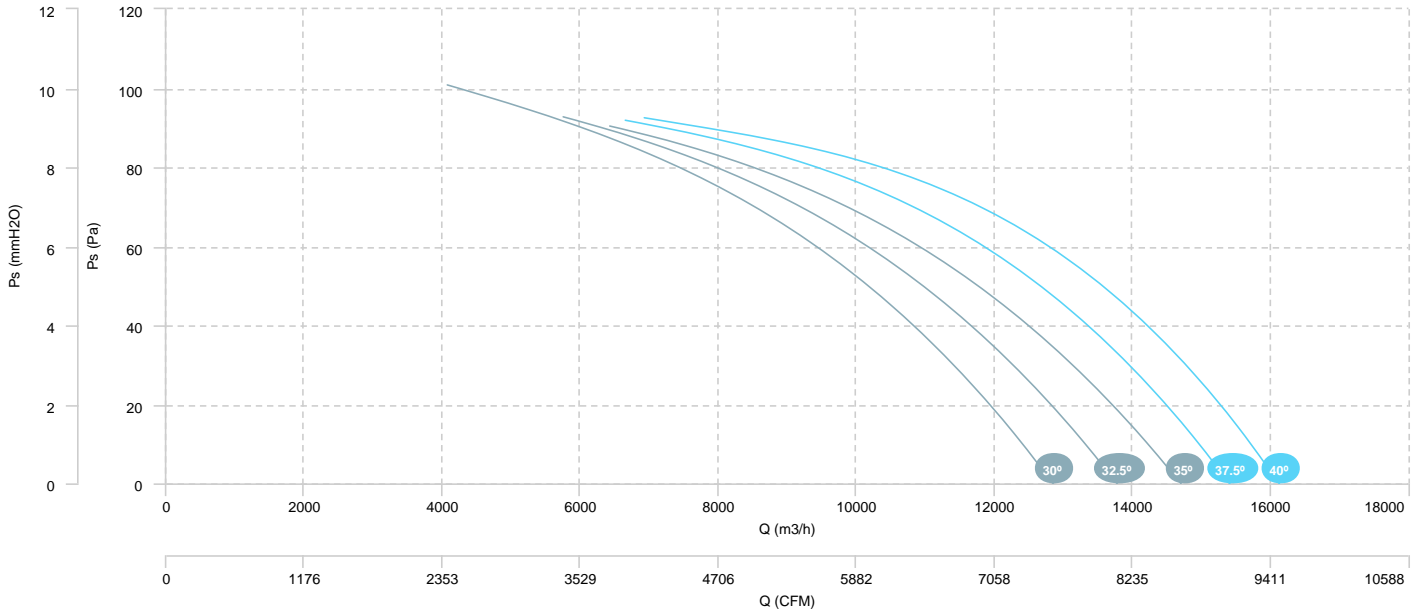

<p>HBF 90 T4 5,5kW (A3:8) F400</p> <p>HBF 90 T4 15kW (A3:8) F400</p>	<p>HBF 90 T4 7,5kW (A3:8) F400</p>	<p>HBF 90 T4 11kW (A3:8) F400</p>
--	------------------------------------	-----------------------------------

AIR FLOW - PRESSURE

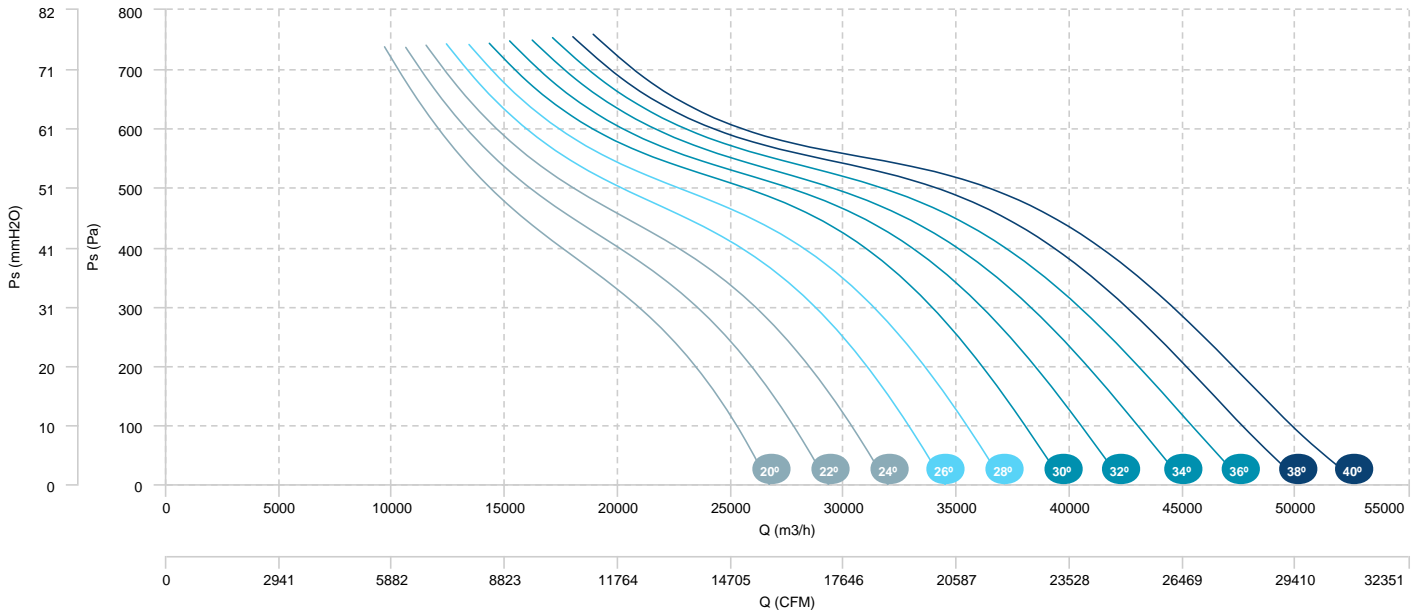

AIR FLOW - ABSORBED POWER

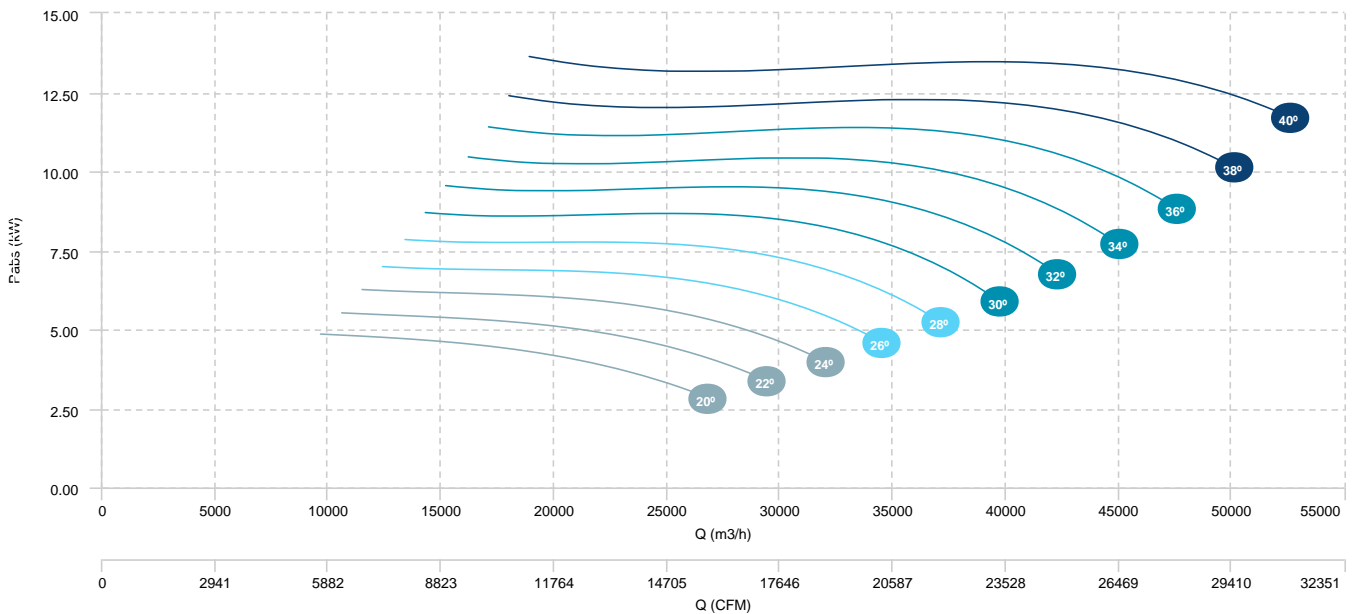

<p>HBF 90 T4 3kW (A3:4) F400</p> <p>HBF 90 T4 7,5kW (A3:4) F400</p>	<p>HBF 90 T4 4kW (A3:4) F400</p> <p>HBF 90 T4 11kW (A3:4) F400</p>	<p>HBF 90 T4 5,5kW (A3:4) F400</p>
---	--	------------------------------------

AIR FLOW - PRESSURE

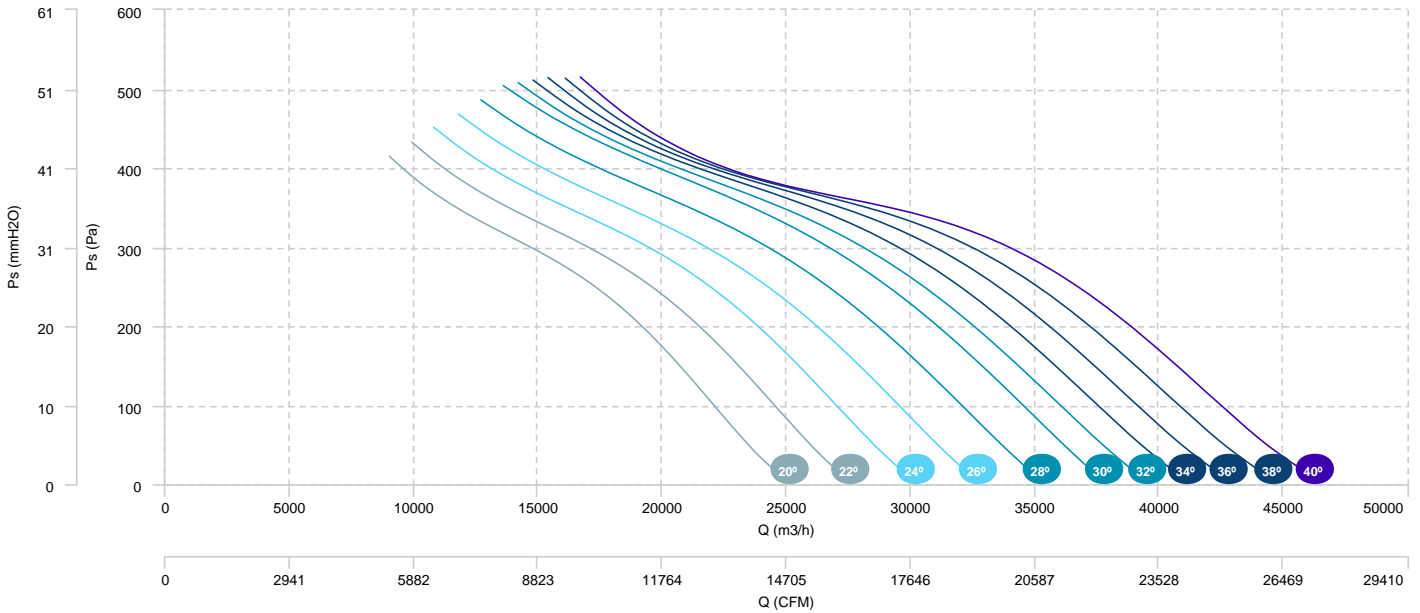

AIR FLOW - ABSORBED POWER

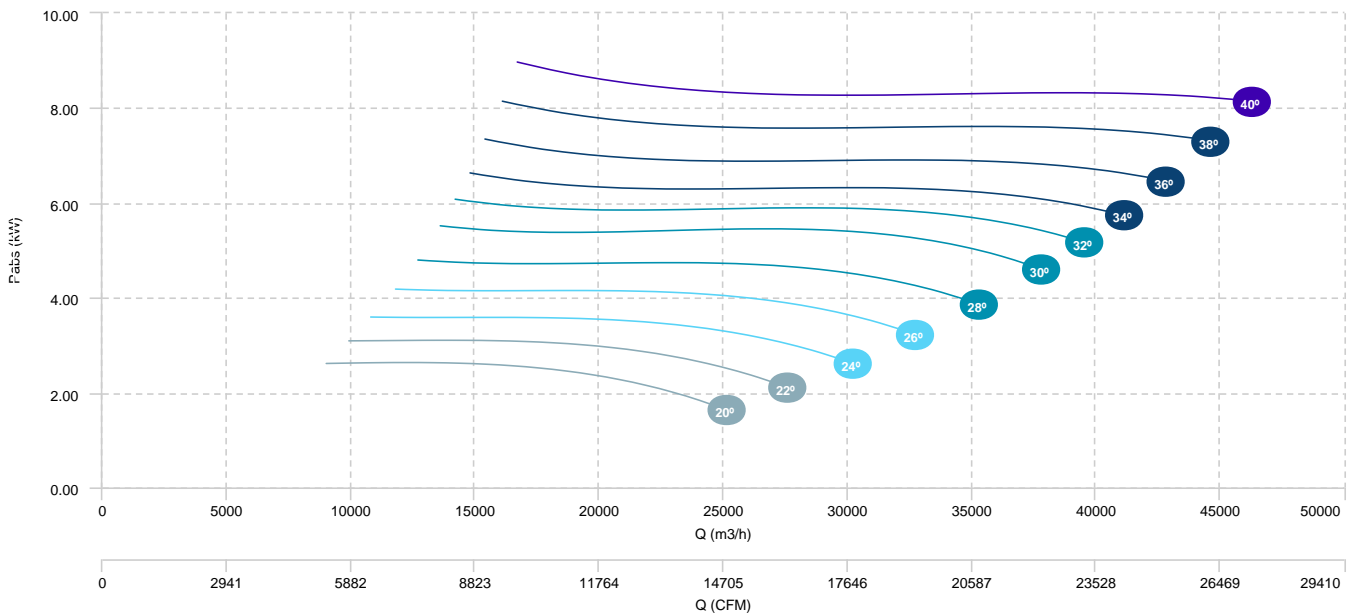

<p>HBF 90 T6 1,5kW (A3:8) F400</p> <p>HBF 90 T6 4kW (A3:8) F400</p>	<p>HBF 90 T6 2,2kW (A3:8) F400</p>	<p>HBF 90 T6 3kW (A3:8) F400</p>
---	------------------------------------	----------------------------------

AIR FLOW - PRESSURE

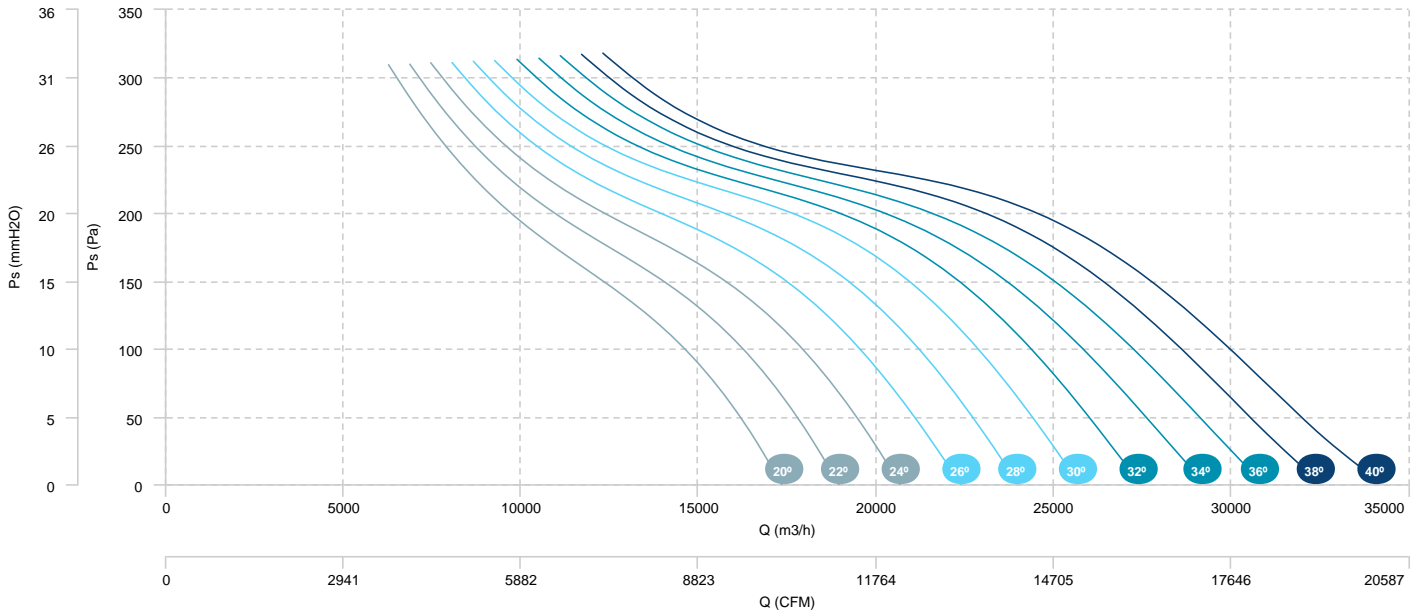

AIR FLOW - ABSORBED POWER

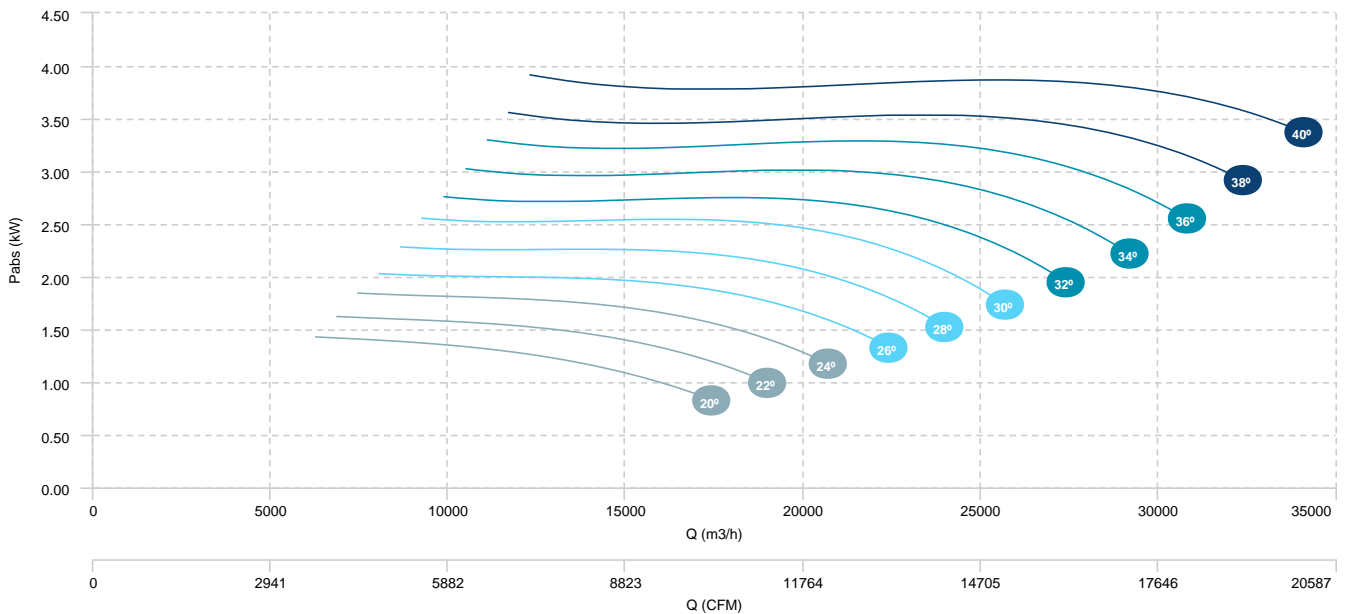

HBF 90 T6 1,5kW (A3:4) F400

HBF 90 T6 2,2kW (A3:4) F400

AIR FLOW - PRESSURE

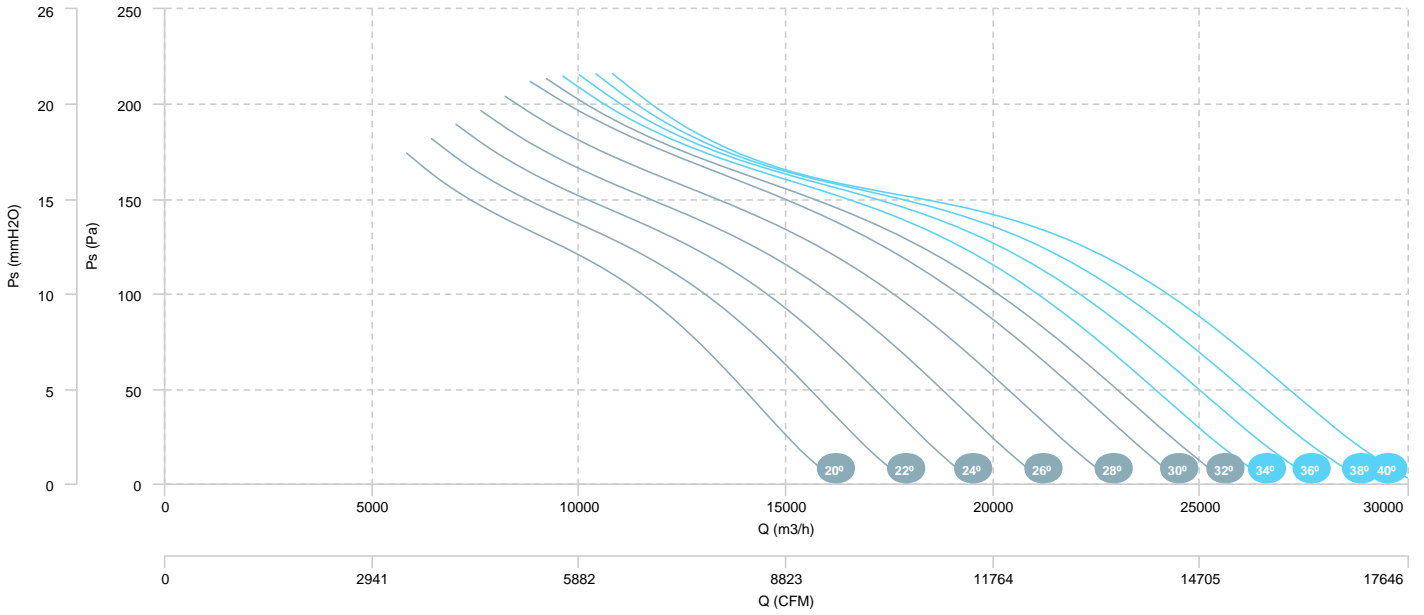

AIR FLOW - ABSORBED POWER

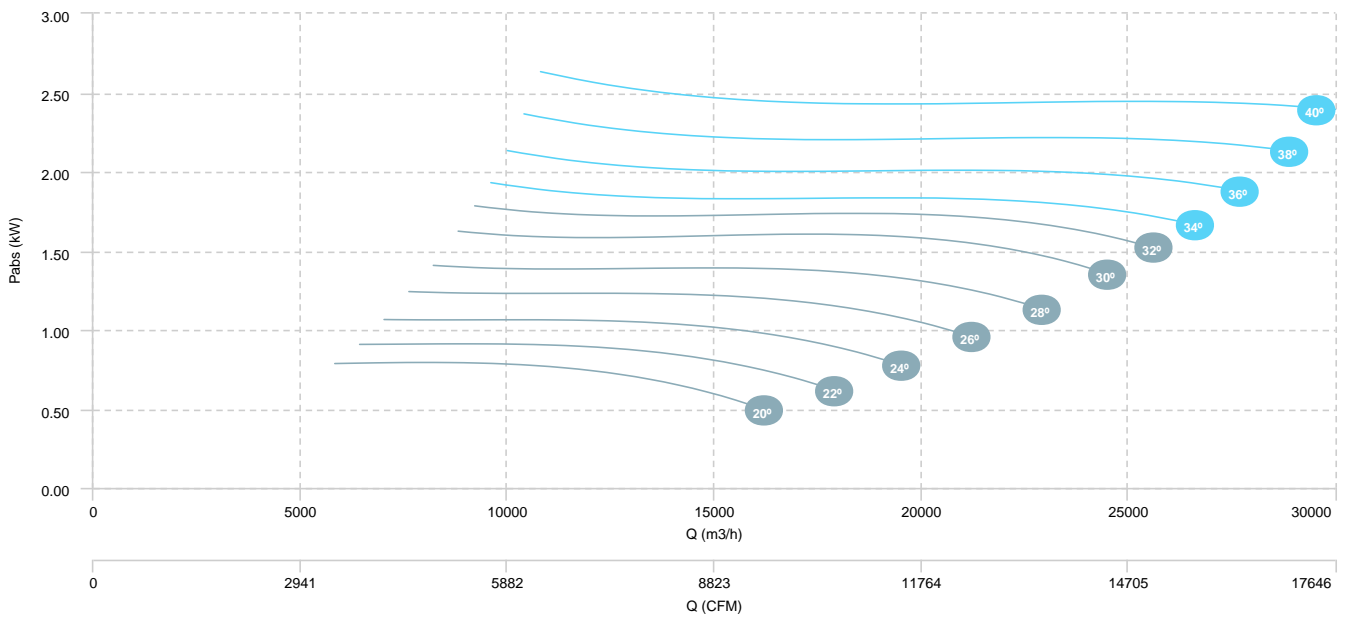

<p>HBF 90 T4/T8 5,5/1,1kW (A3:8) F400</p> <p>HBF 90 T4/T8 14/3,5kW (A3:8) F400</p>	<p>HBF 90 T4/T8 7,5/1,5kW (A3:8) F400</p>	<p>HBF 90 T4/T8 11/3kW (A3:8) F400</p>
--	---	--

AIR FLOW - PRESSURE (4 poles)

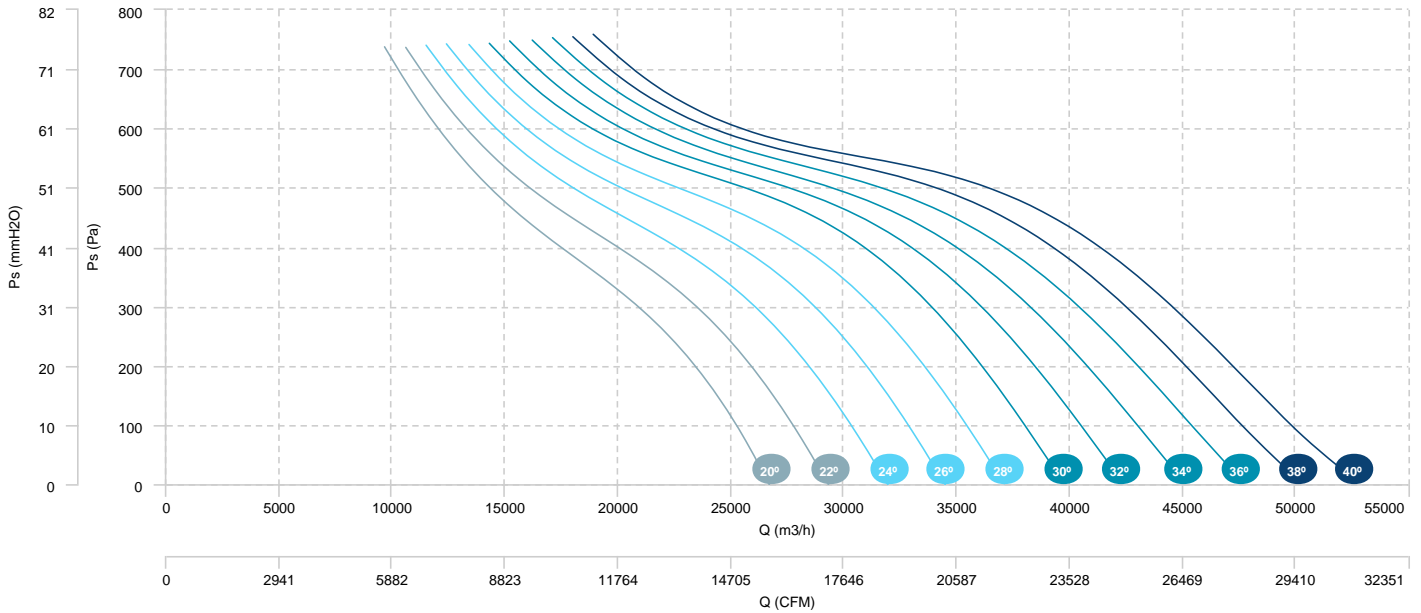

AIR FLOW - ABSORBED POWER (4 poles)

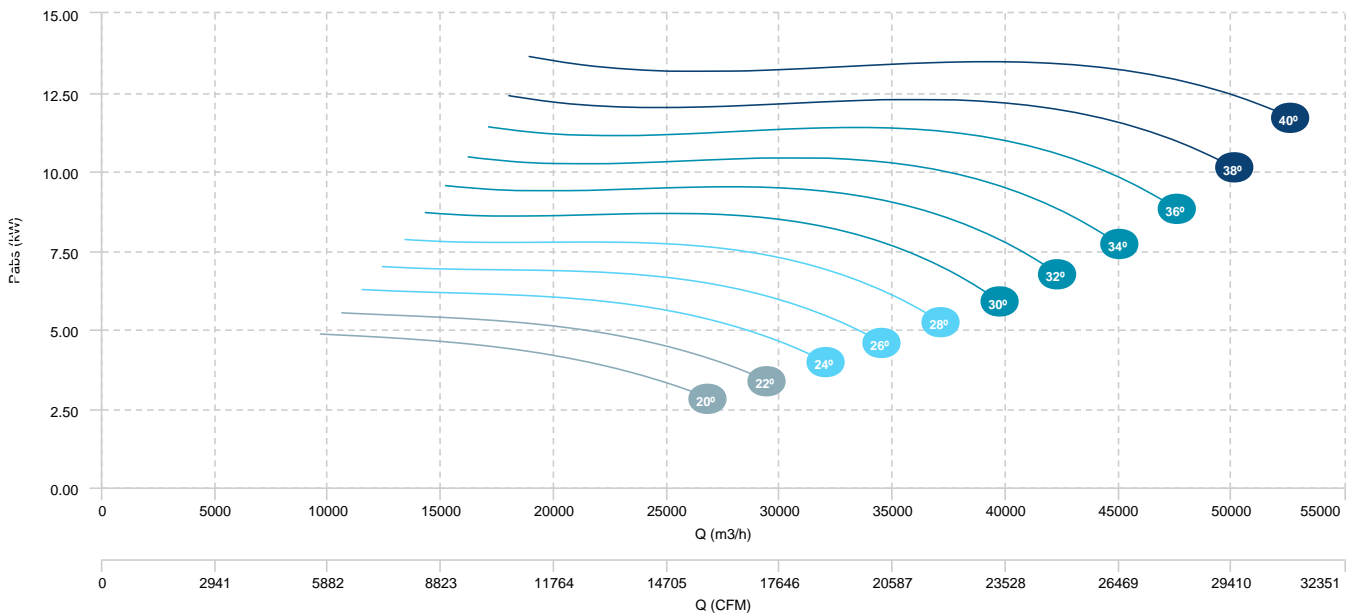

HBF 90 T4/T8 5,5/1,1kW (A3:8) F400

HBF 90 T4/T8 7,5/1,5kW (A3:8) F400

HBF 90 T4/T8 11/3kW (A3:8) F400

HBF 90 T4/T8 14/3,5kW (A3:8) F400

AIR FLOW - PRESSURE (8 poles)

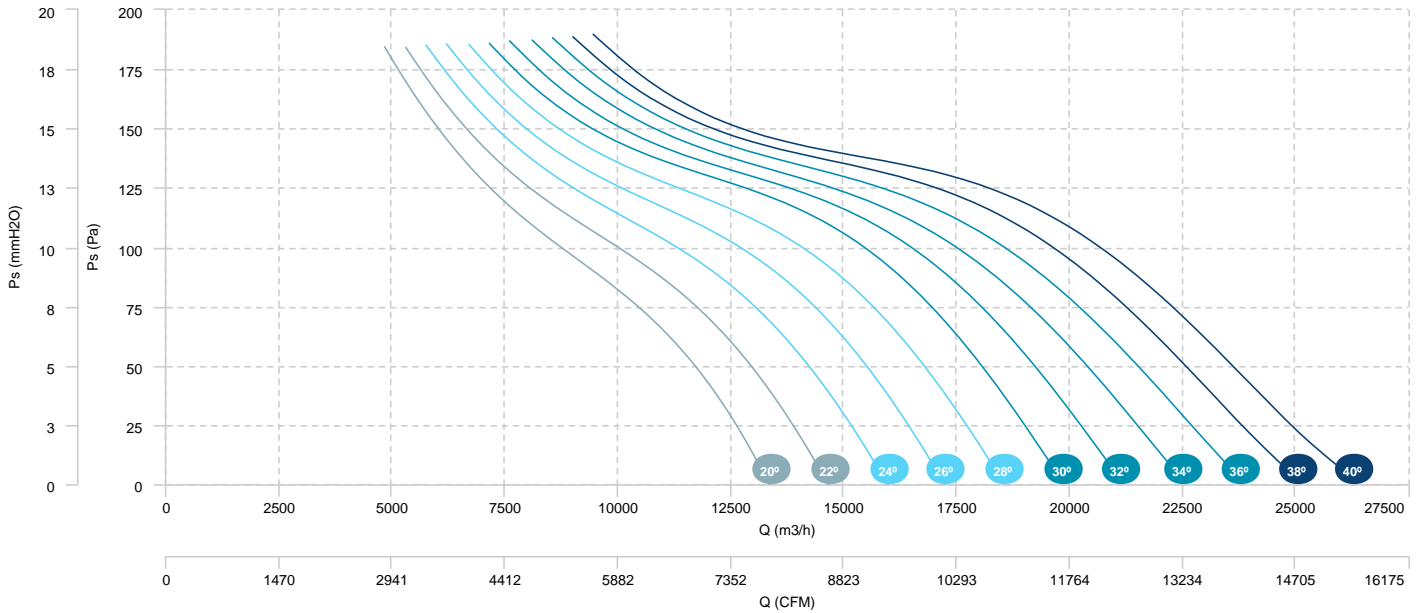

<p>HBF 90 T4/T8 2,8/0,7kW (A3:4) F400</p> <p>HBF 90 T4/T8 7,5/1,5kW (A3:4) F400</p>	<p>HBF 90 T4/T8 4/0,75kW (A3:4) F400</p> <p>HBF 90 T4/T8 11/3kW (A3:4) F400</p>	<p>HBF 90 T4/T8 5,5/1,1kW (A3:4) F400</p>
---	---	---

AIR FLOW - PRESSURE (4 poles)

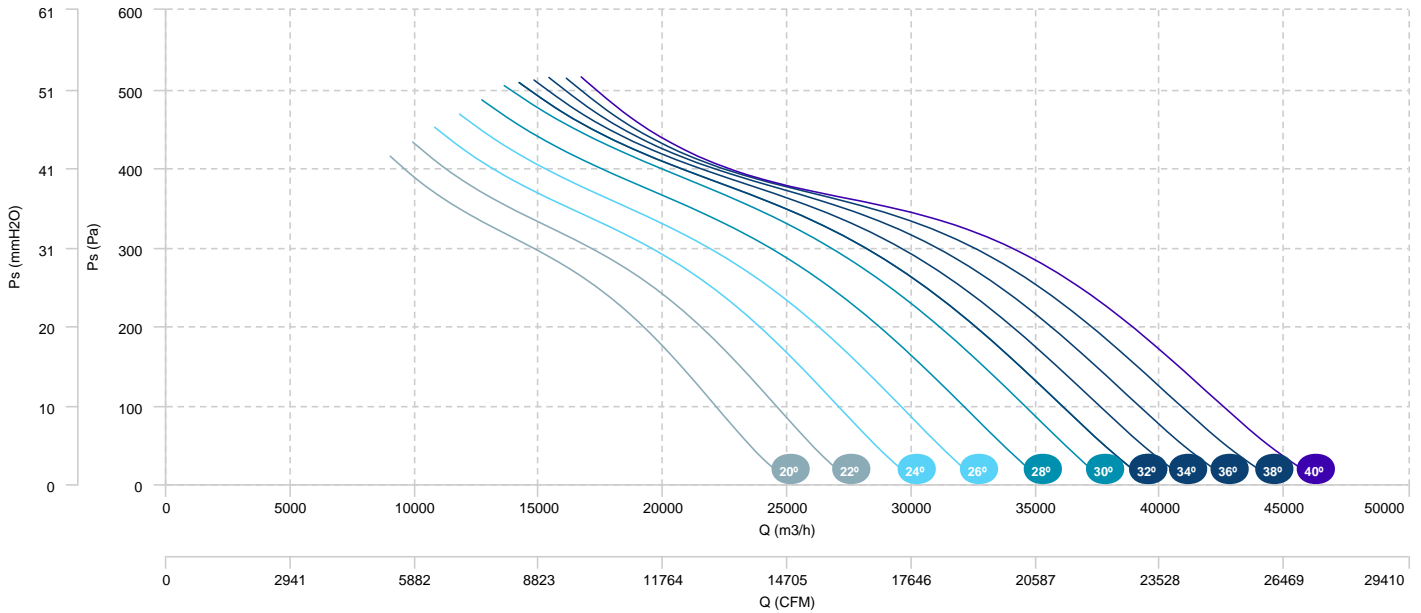

AIR FLOW - ABSORBED POWER (4 poles)

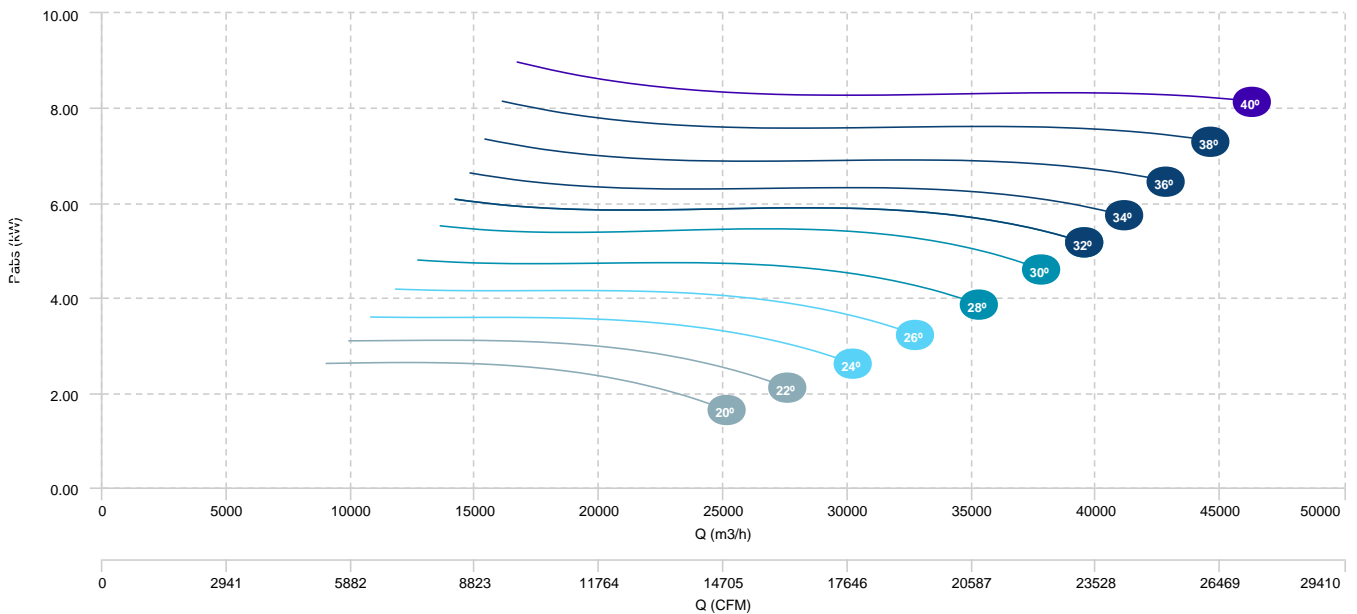

<p>HBF 90 T4/T8 2,8/0,7kW (A3:4) F400</p> <p>HBF 90 T4/T8 7,5/1,5kW (A3:4) F400</p>	<p>HBF 90 T4/T8 4/0,75kW (A3:4) F400</p> <p>HBF 90 T4/T8 11/3kW (A3:4) F400</p>	<p>HBF 90 T4/T8 5,5/1,1kW (A3:4) F400</p>
---	---	---

AIR FLOW - PRESSURE (8 poles)

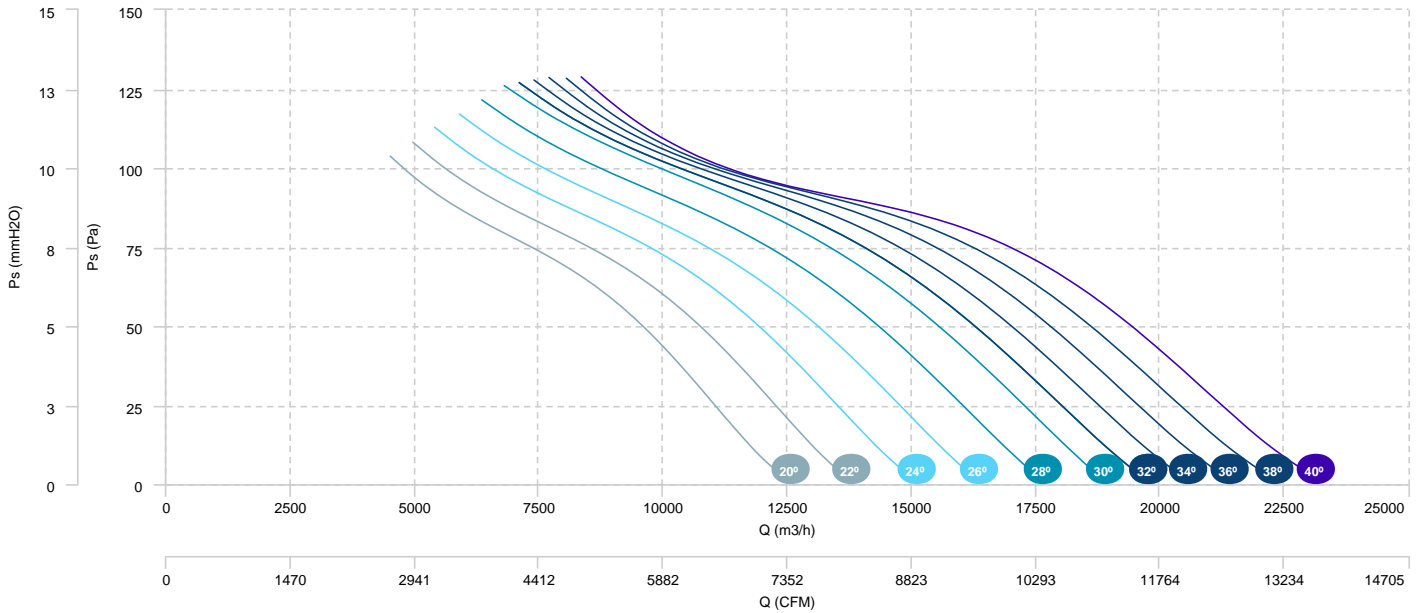

<p>HBF 100 T4 7,5kW (A3:8) F400</p> <p>HBF 100 T4 18,5kW (A3:8) F400</p>	<p>HBF 100 T4 11kW (A3:8) F400</p> <p>HBF 100 T4 22kW (A3:8) F400</p>	<p>HBF 100 T4 15kW (A3:8) F400</p>
--	---	------------------------------------

AIR FLOW - PRESSURE

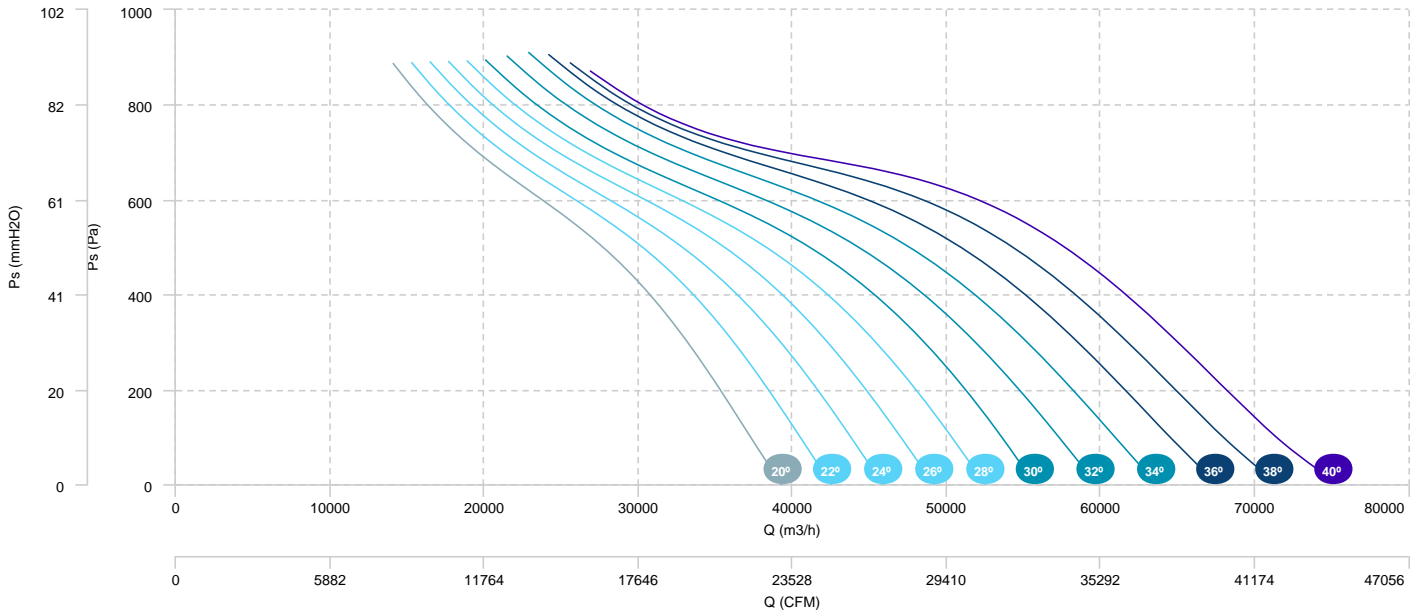

AIR FLOW - ABSORBED POWER

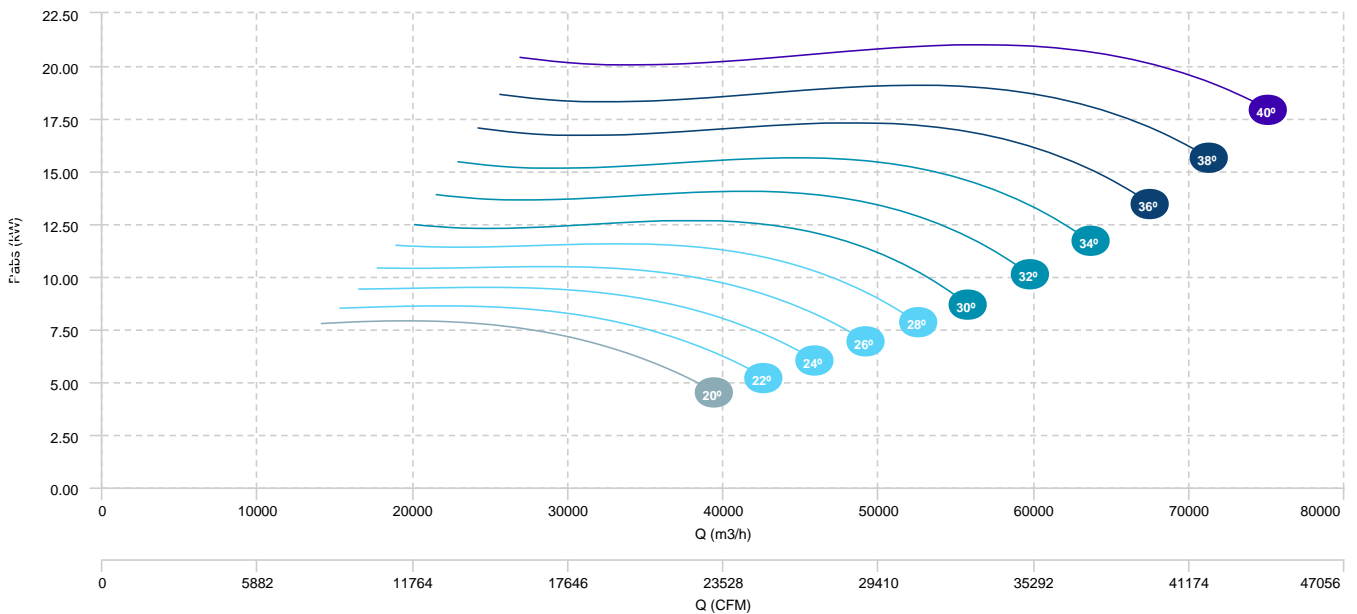

<p>HBF 100 T4 5,5kW (A3:4) F400</p> <p>HBF 100 T4 15kW (A3:4) F400</p>	<p>HBF 100 T4 7,5kW (A3:4) F400</p>	<p>HBF 100 T4 11kW (A3:4) F400</p>
--	-------------------------------------	------------------------------------

AIR FLOW - PRESSURE

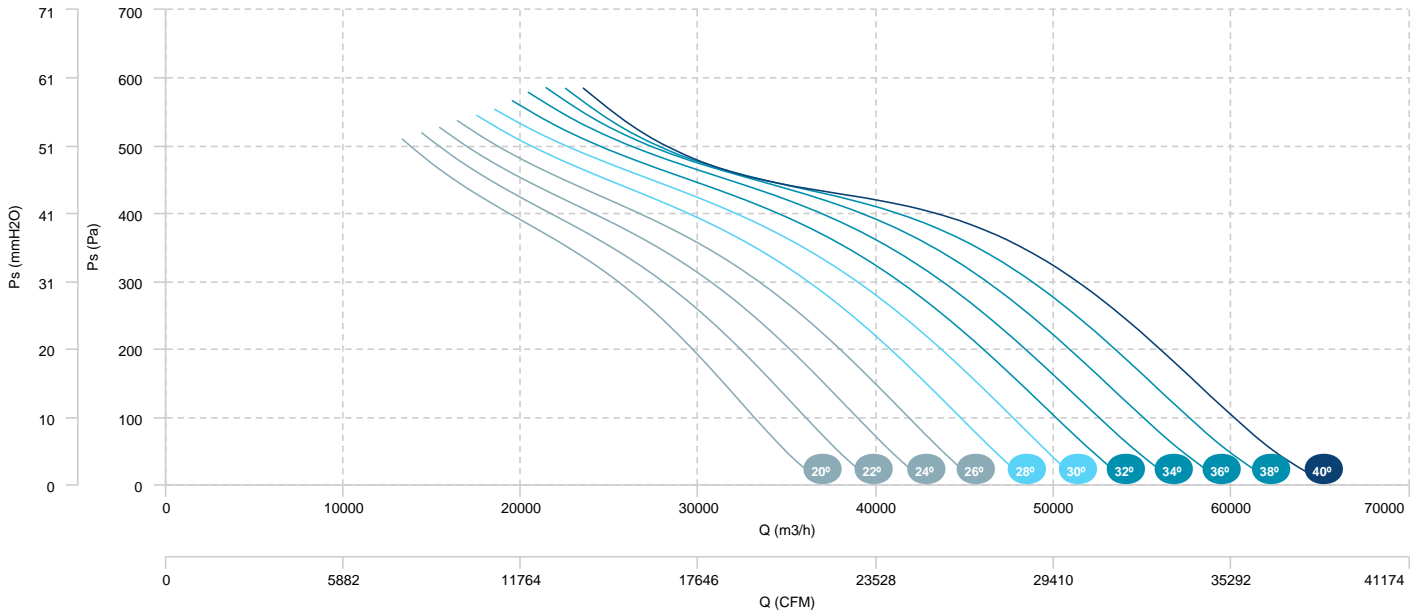

AIR FLOW - ABSORBED POWER

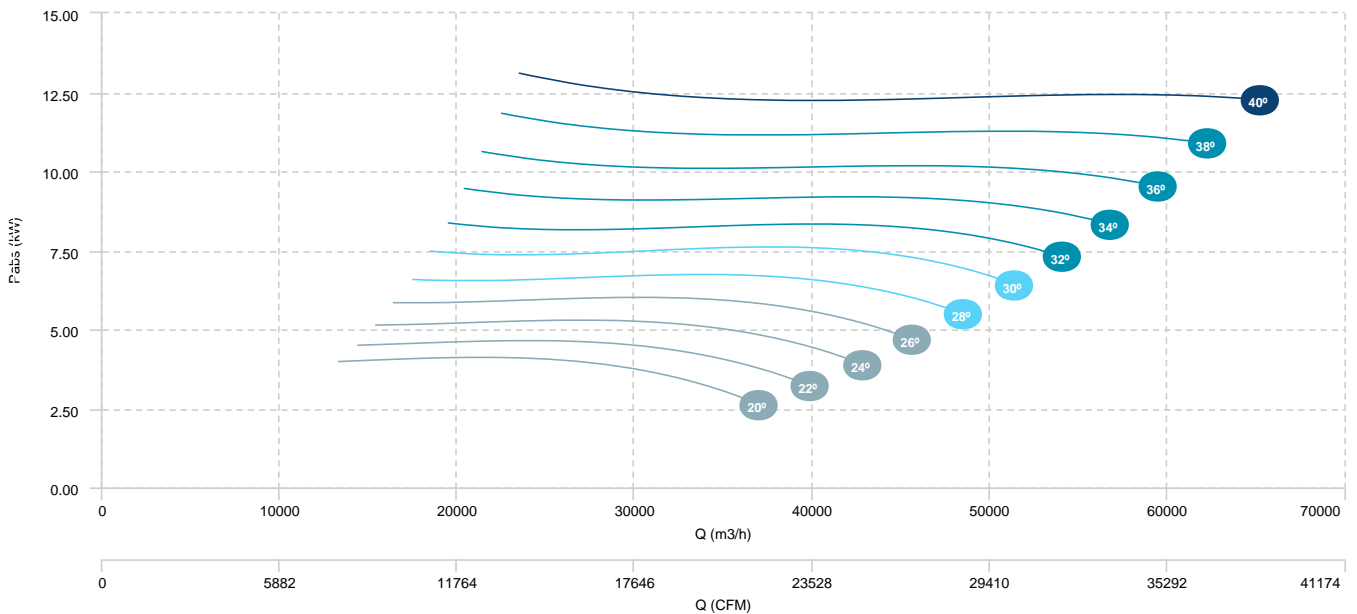

HBF 100 T6 2,2kW (A3:8) F400
HBF 100 T6 5,5kW (A3:8) F400

HBF 100 T6 3kW (A3:8) F400

HBF 100 T6 4kW (A3:8) F400

AIR FLOW - PRESSURE

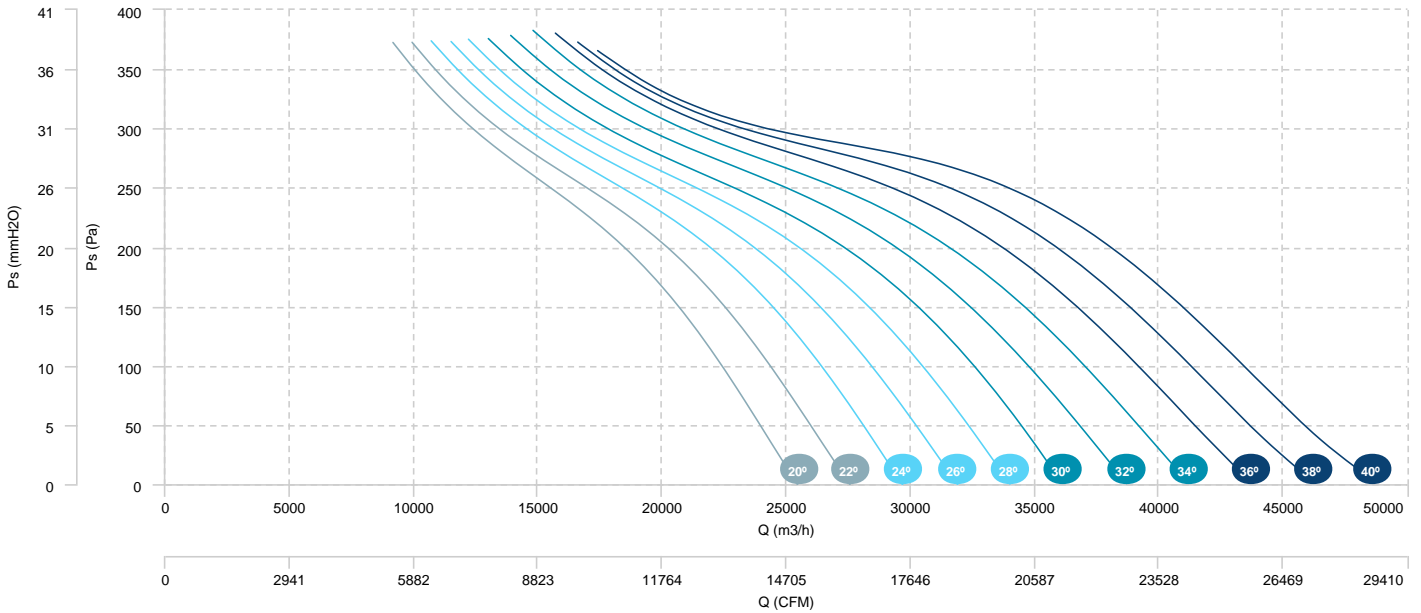

AIR FLOW - ABSORBED POWER

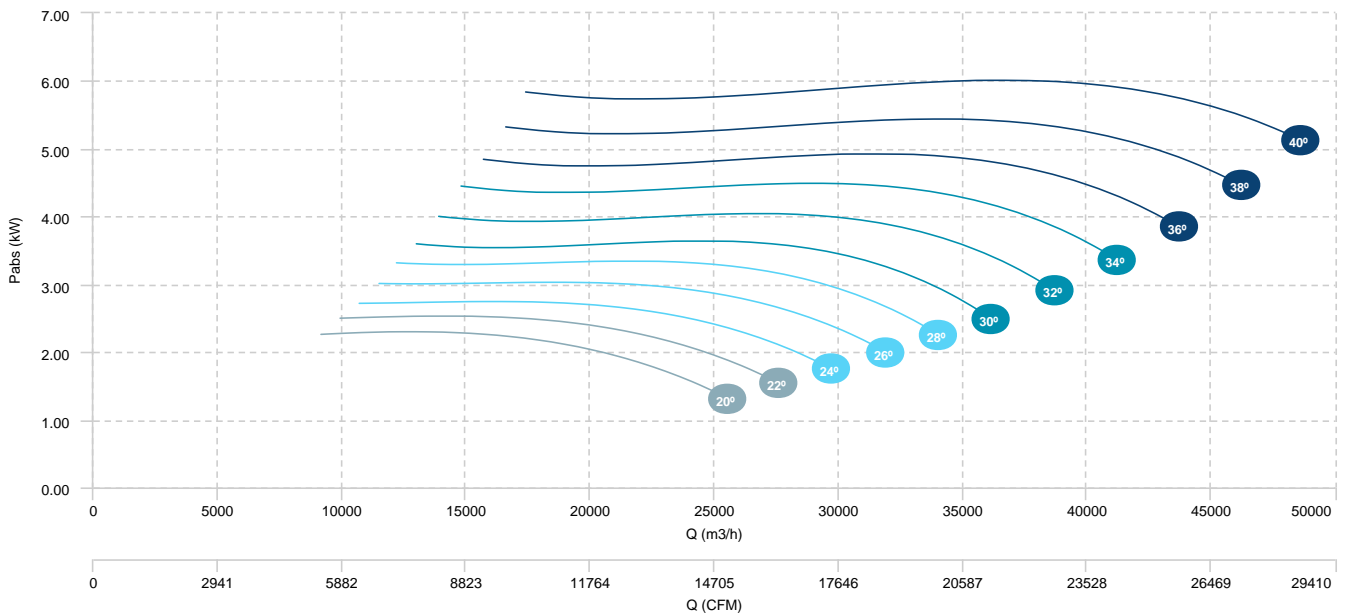

<p>■ HBF 100 T6 1,5kW (A3:4) F400</p> <p>■ HBF 100 T6 4kW (A3:4) F400</p>	<p>■ HBF 100 T6 2,2kW (A3:4) F400</p>	<p>■ HBF 100 T6 3kW (A3:4) F400</p>
---	---------------------------------------	-------------------------------------

AIR FLOW - PRESSURE

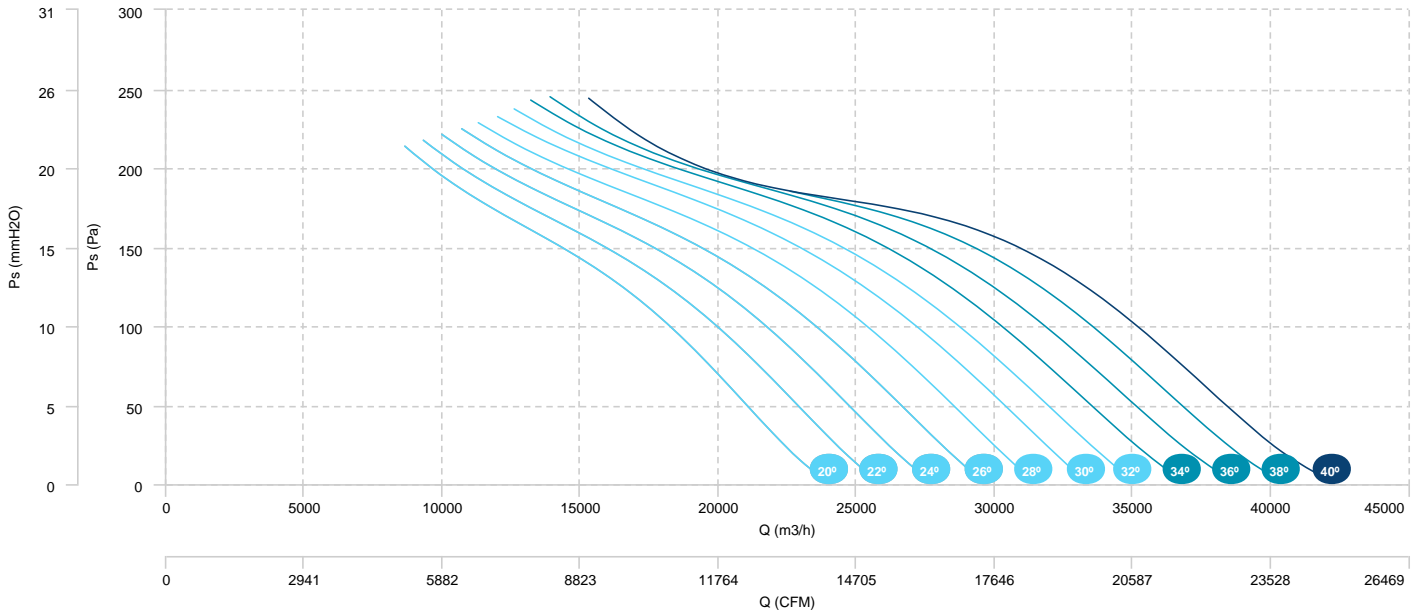

AIR FLOW - ABSORBED POWER

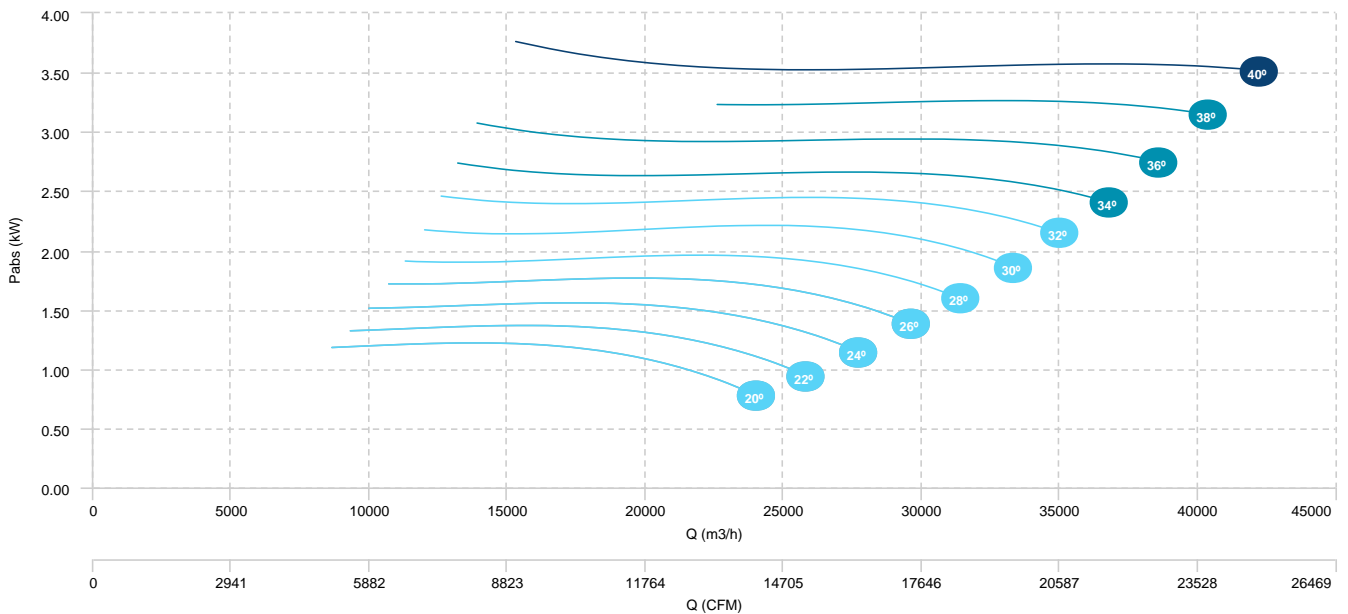

<p>HBF 100 T4/T8 7,5/1,5kW (A3:8) F400</p> <p>HBF 100 T4/T8 17/4,3kW (A3:8) F400</p>	<p>HBF 100 T4/T8 11/3kW (A3:8) F400</p> <p>HBF 100 T4/T8 20/5kW (A3:8) F400</p>	<p>HBF 100 T4/T8 14/3,5kW (A3:8) F400</p>
--	---	---

AIR FLOW - PRESSURE (4 poles)

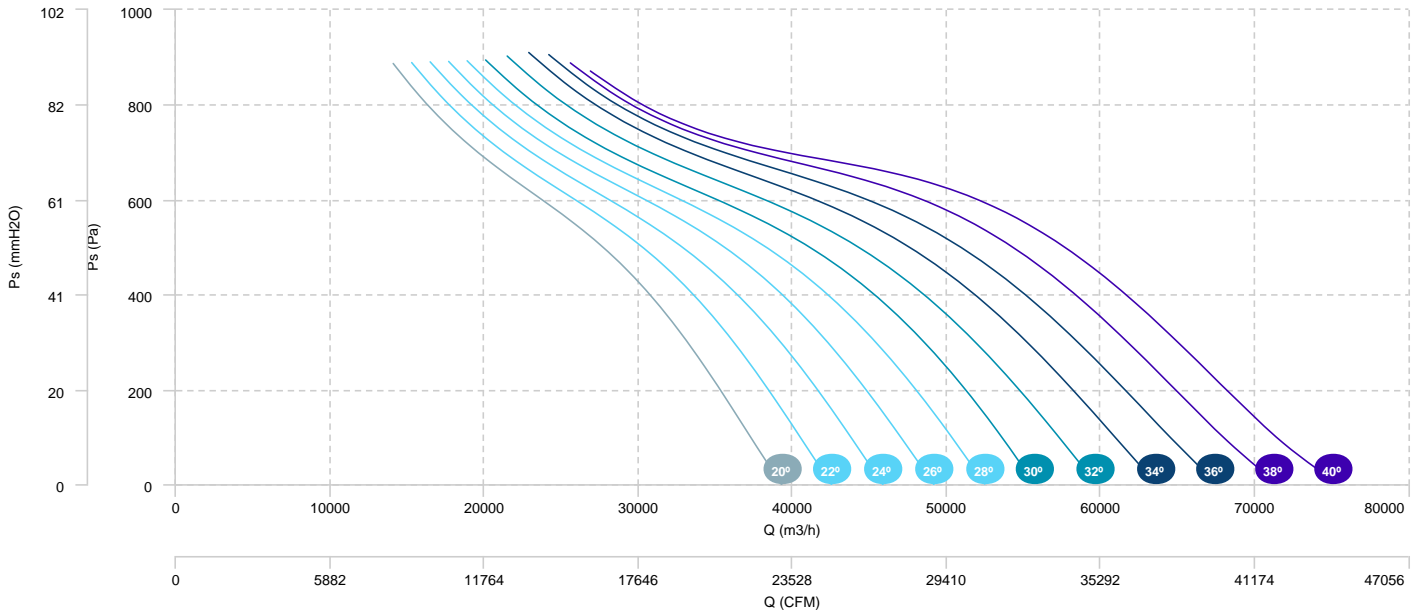

AIR FLOW - ABSORBED POWER (4 poles)

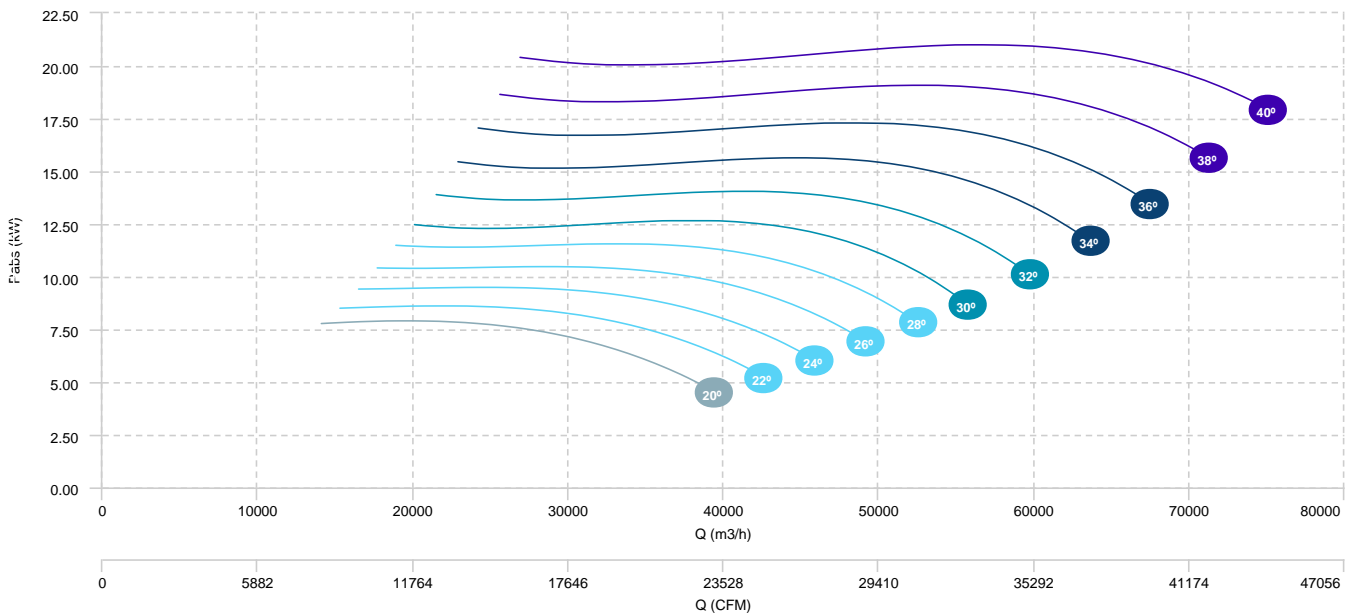

<p>HBF 100 T4/T8 7,5/1,5kW (A3:8) F400</p> <p>HBF 100 T4/T8 17/4,3kW (A3:8) F400</p>	<p>HBF 100 T4/T8 11/3kW (A3:8) F400</p> <p>HBF 100 T4/T8 20/5kW (A3:8) F400</p>	<p>HBF 100 T4/T8 14/3,5kW (A3:8) F400</p>
--	---	---

AIR FLOW - PRESSURE (8 poles)

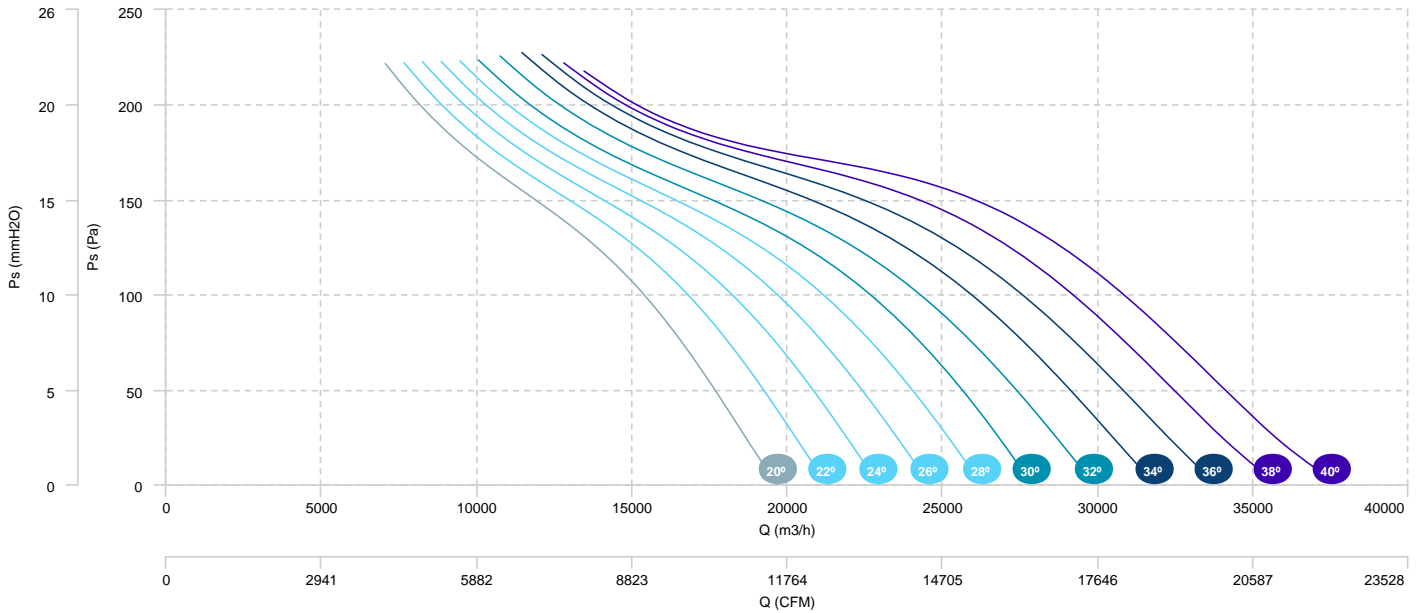

<p>HBF 100 T4/T8 5,5/1,1kW (A3:4) F400</p> <p>HBF 100 T4/T8 14/3,5kW (A3:4) F400</p>	<p>HBF 100 T4/T8 7,5/1,5kW (A3:4) F400</p>	<p>HBF 100 T4/T8 11/3kW (A3:4) F400</p>
--	--	---

AIR FLOW - PRESSURE (4 poles)

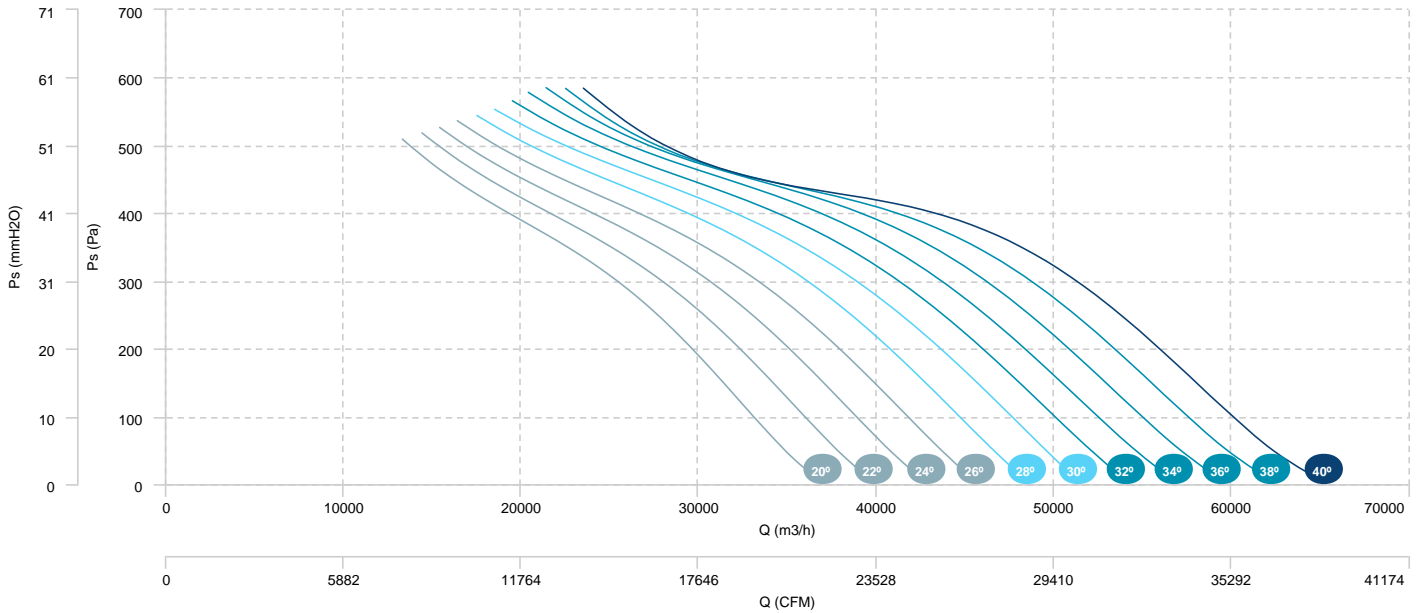

AIR FLOW - ABSORBED POWER (4 poles)

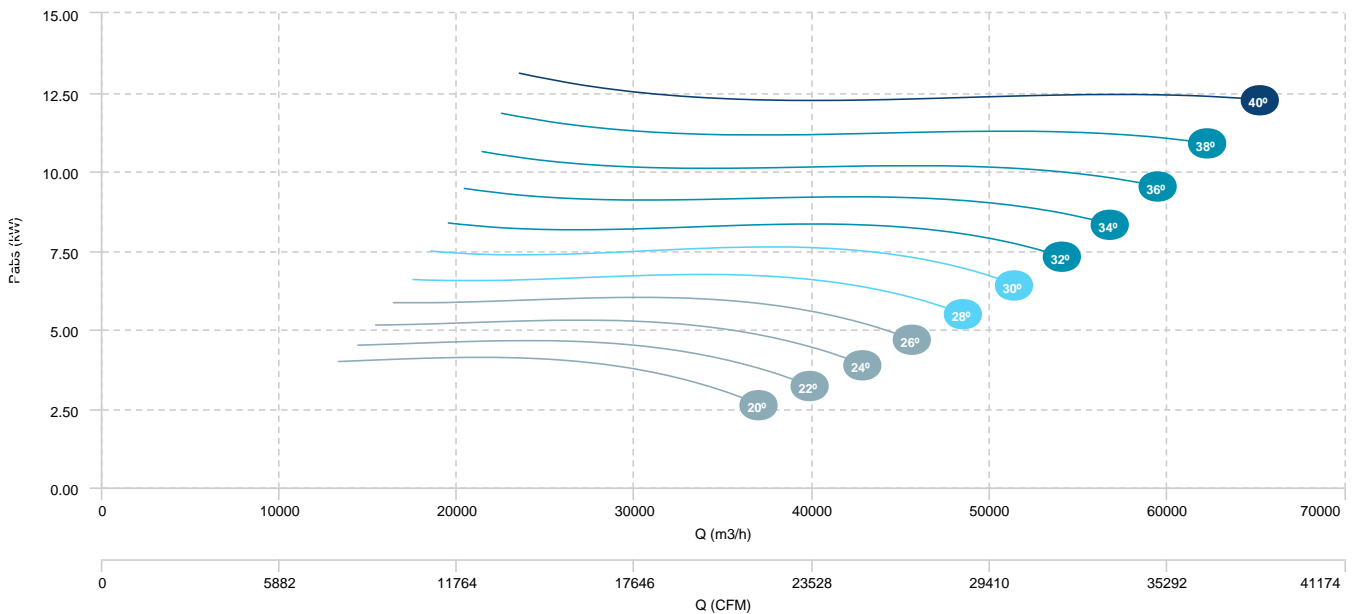

HBF 100 T4/T8 5,5/1,1kW (A3:4) F400

HBF 100 T4/T8 7,5/1,5kW (A3:4) F400

HBF 100 T4/T8 11/3kW (A3:4) F400

HBF 100 T4/T8 14/3,5kW (A3:4) F400

AIR FLOW - PRESSURE (8 poles)

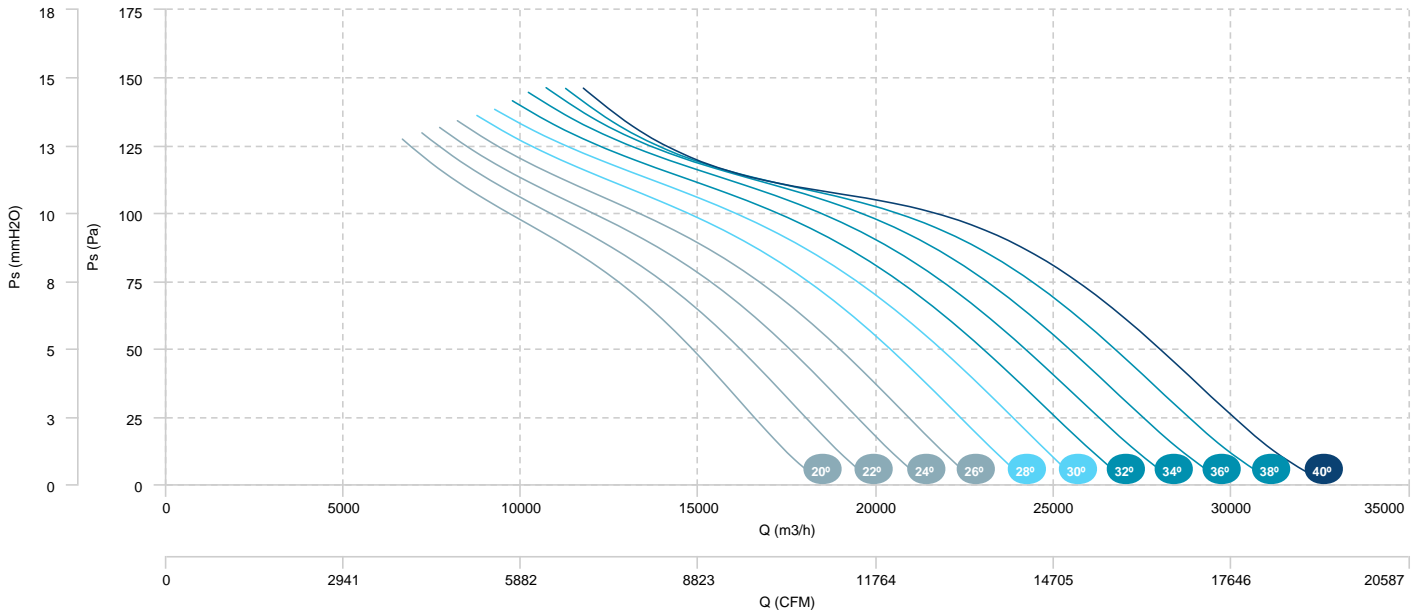

<p>HBF 112 T4 11kW (A3:8) F400</p> <p>HBF 112 T4 22kW (A3:8) F400</p>	<p>HBF 112 T4 15kW (A3:8) F400</p> <p>HBF 112 T4 30kW (A3:8) F400</p>	<p>HBF 112 T4 18,5kW (A3:8) F400</p>
---	---	--------------------------------------

AIR FLOW - PRESSURE

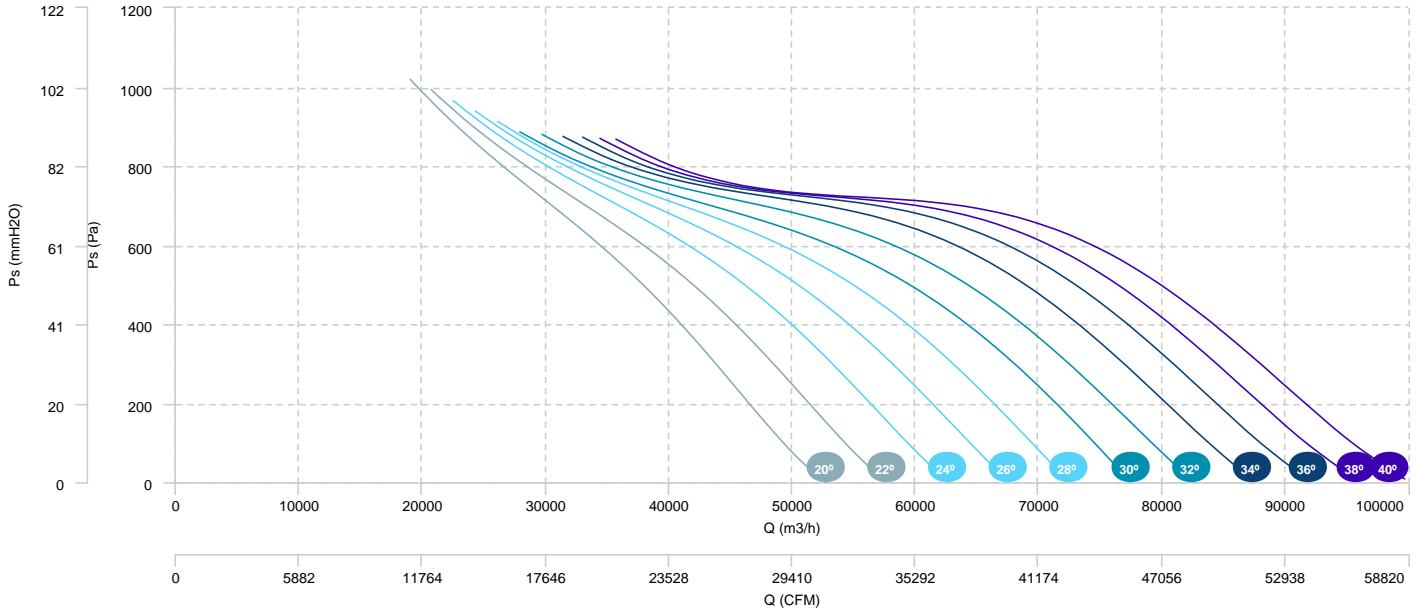

AIR FLOW - ABSORBED POWER

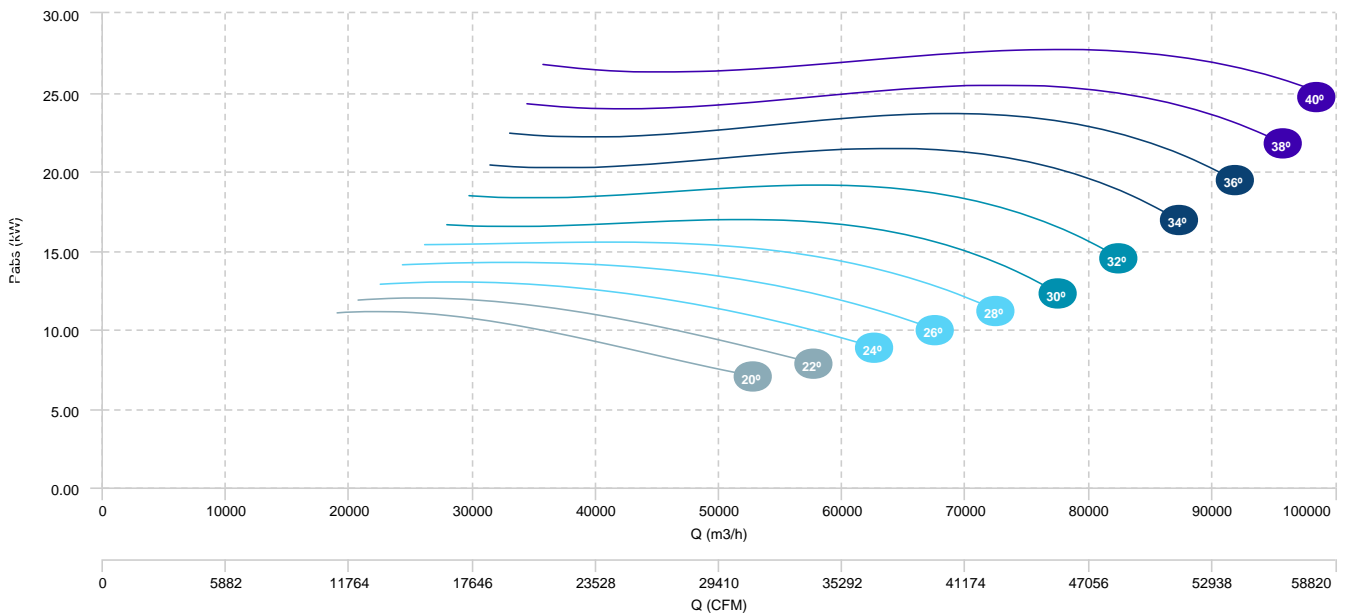

<p>HBF 112 T4 5,5kW (A3:4) F400</p> <p>HBF 112 T4 15kW (A3:4) F400</p>	<p>HBF 112 T4 7,5kW (A3:4) F400</p> <p>HBF 112 T4 18,5kW (A3:4) F400</p>	<p>HBF 112 T4 11kW (A3:4) F400</p>
--	--	------------------------------------

AIR FLOW - PRESSURE

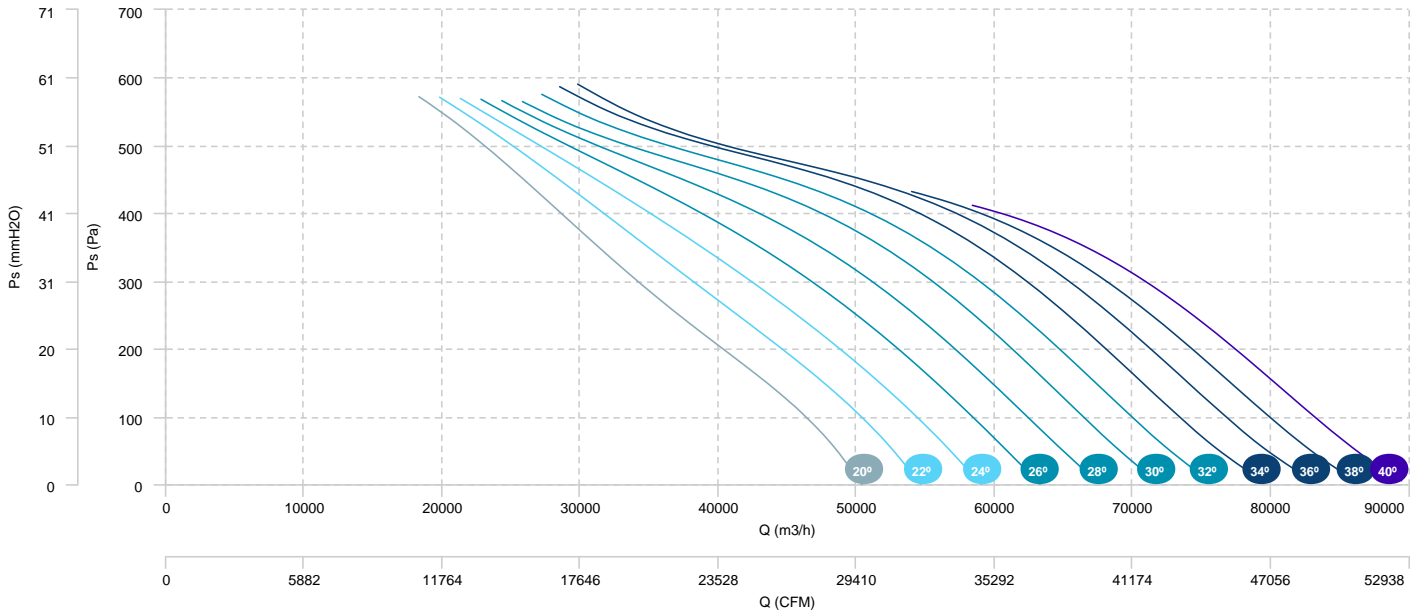

AIR FLOW - ABSORBED POWER

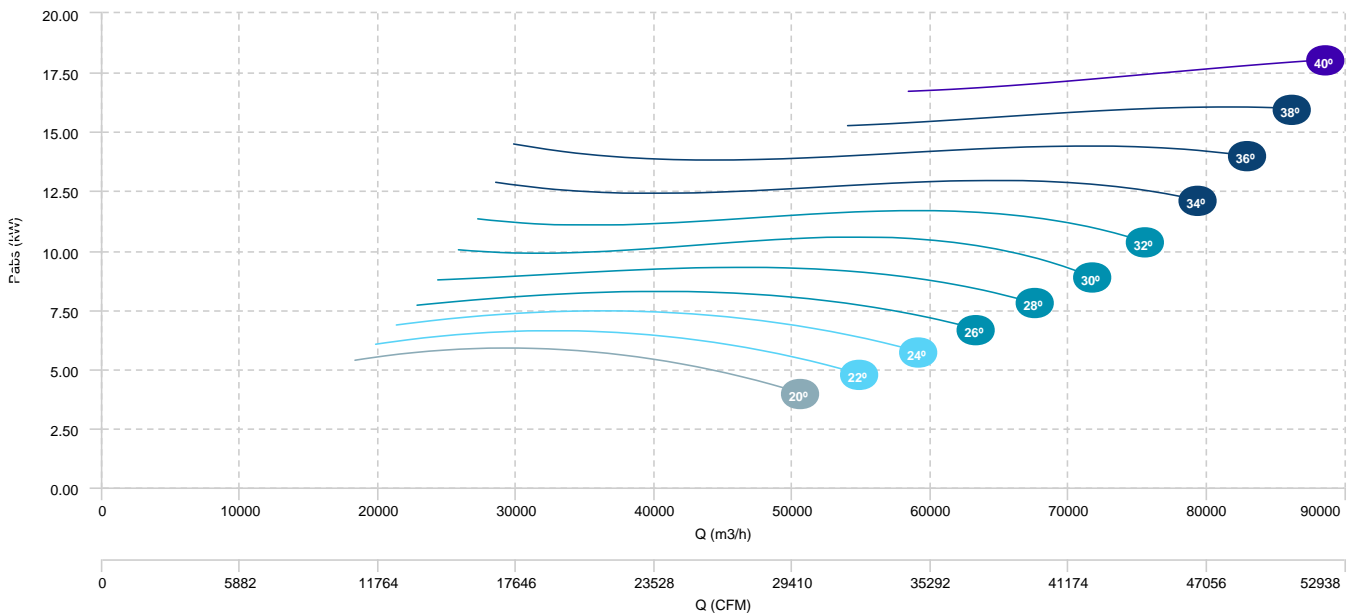

HBF 112 T6 3kW (A3:8) F400
HBF 112 T6 7,5kW (A3:8) F400

HBF 112 T6 4kW (A3:8) F400

HBF 112 T6 5,5kW (A3:8) F400

AIR FLOW - PRESSURE

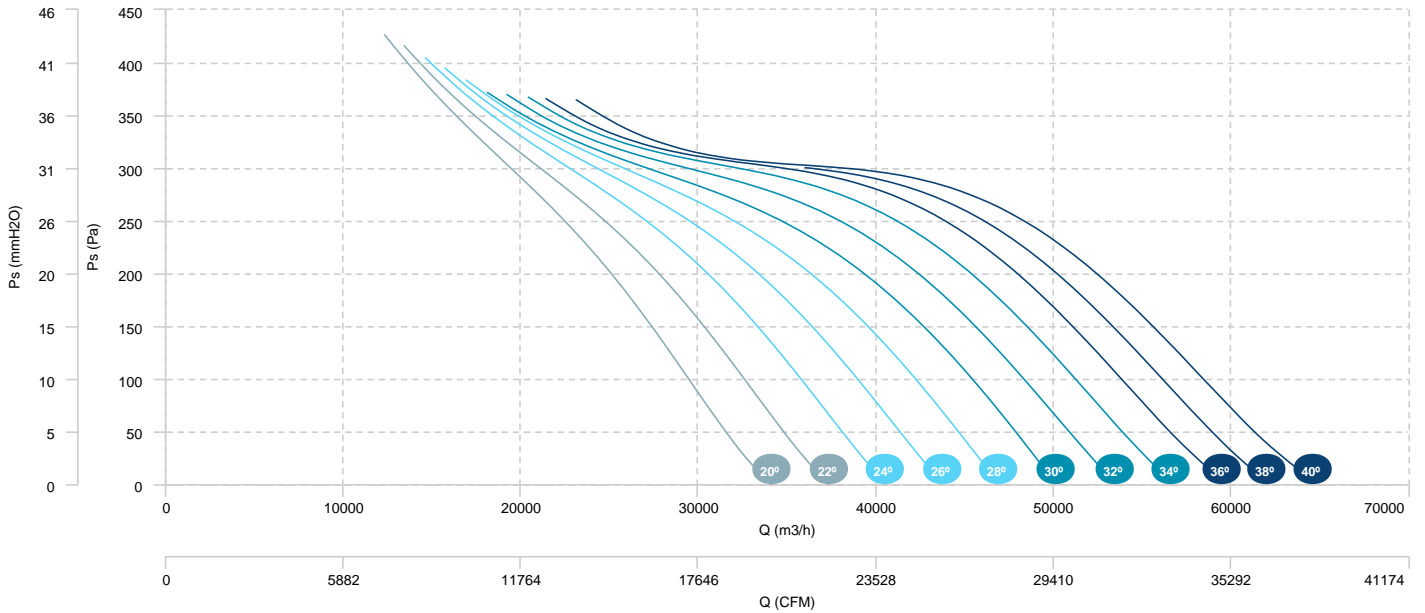

AIR FLOW - ABSORBED POWER

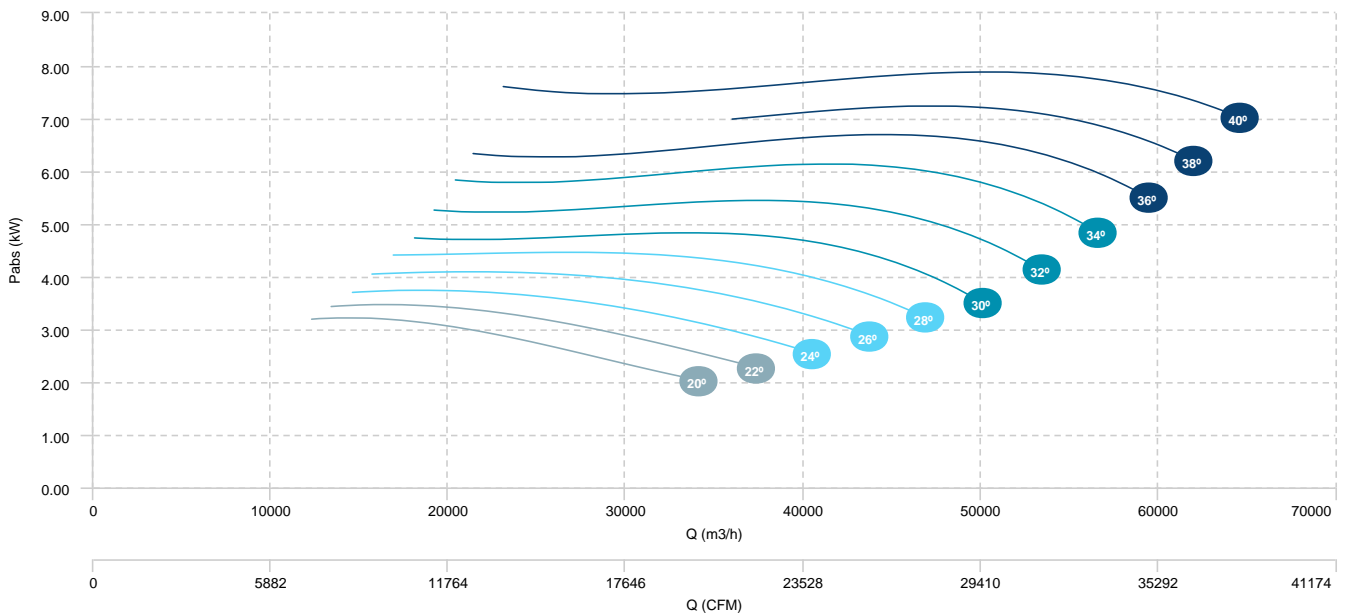

HBF 112 T6 2,2kW (A3:4) F400
HBF 112 T6 5,5kW (A3:4) F400

HBF 112 T6 3kW (A3:4) F400

HBF 112 T6 4kW (A3:4) F400

AIR FLOW - PRESSURE

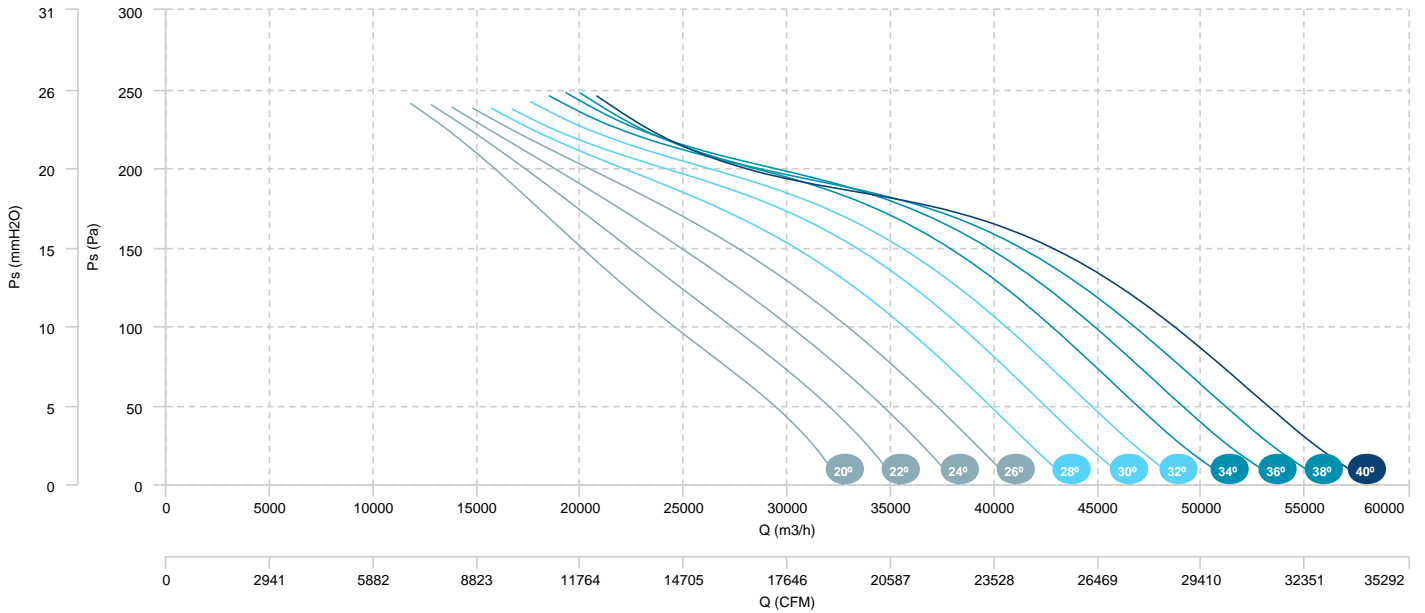

AIR FLOW - ABSORBED POWER

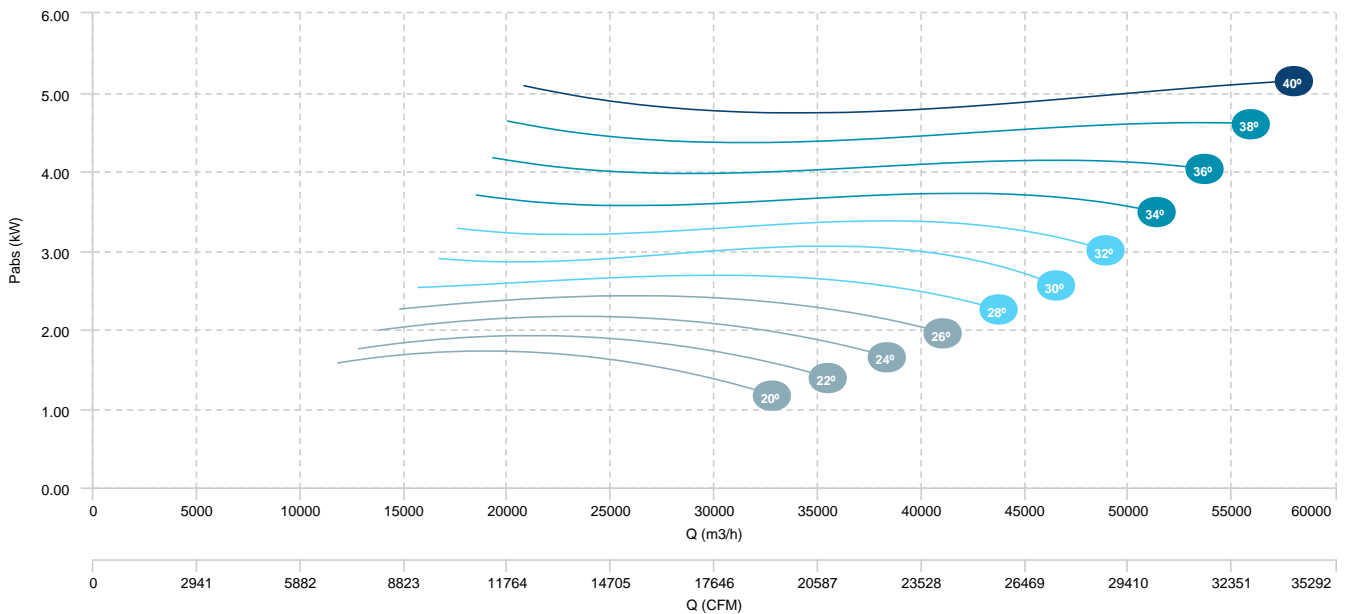

<p>HBF 112 T4/T8 11/3kW (A3:8) F400</p> <p>HBF 112 T4/T8 20/5kW (A3:8) F400</p>	<p>HBF 112 T4/T8 14/3,5kW (A3:8) F400</p> <p>HBF 112 T4/T8 28/6,5kW (A3:8) F400</p>	<p>HBF 112 T4/T8 17/4,3kW (A3:8) F400</p>
---	---	---

AIR FLOW - PRESSURE (4 poles)

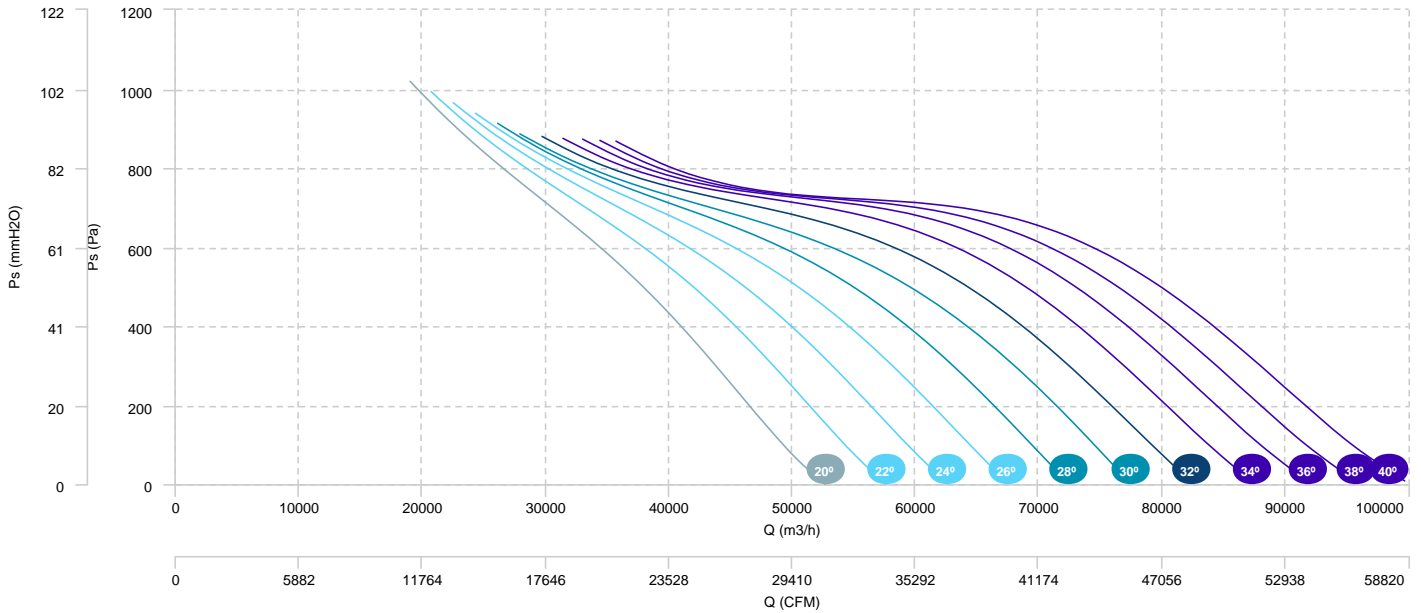

AIR FLOW - ABSORBED POWER (4 poles)

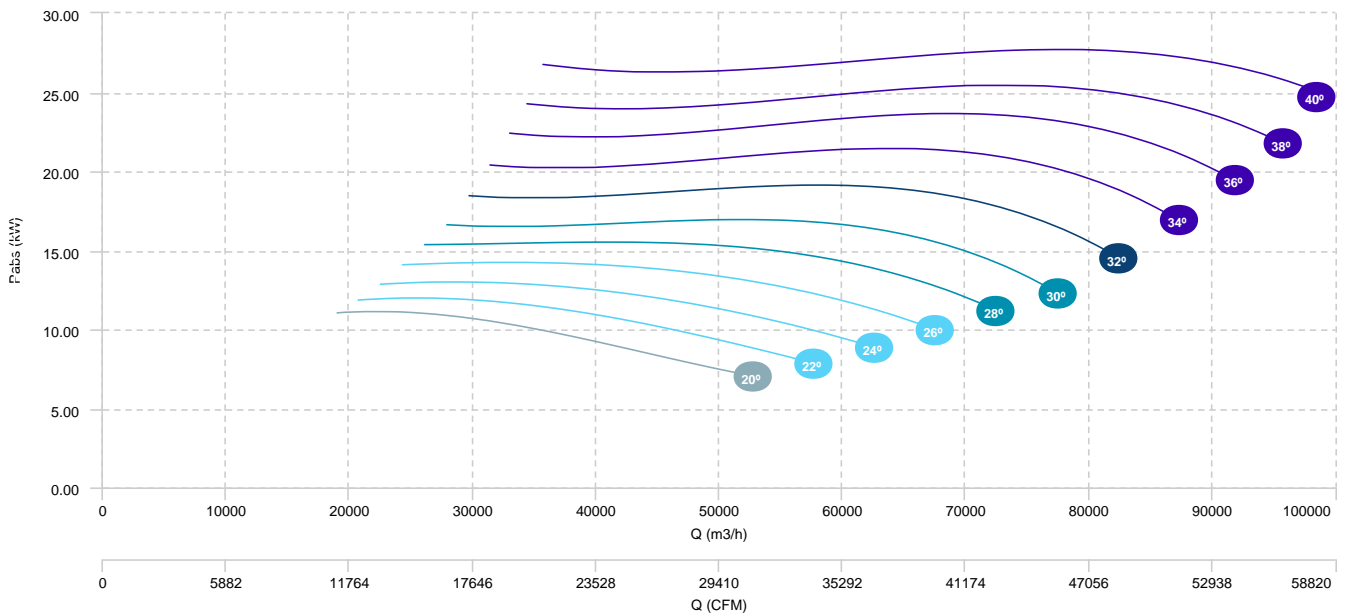

<p>■ HBF 112 T4/T8 11/3kW (A3:8) F400</p> <p>■ HBF 112 T4/T8 20/5kW (A3:8) F400</p>	<p>■ HBF 112 T4/T8 14/3,5kW (A3:8) F400</p> <p>■ HBF 112 T4/T8 28/6,5kW (A3:8) F400</p>	<p>■ HBF 112 T4/T8 17/4,3kW (A3:8) F400</p>
---	---	---

AIR FLOW - PRESSURE (8 poles)

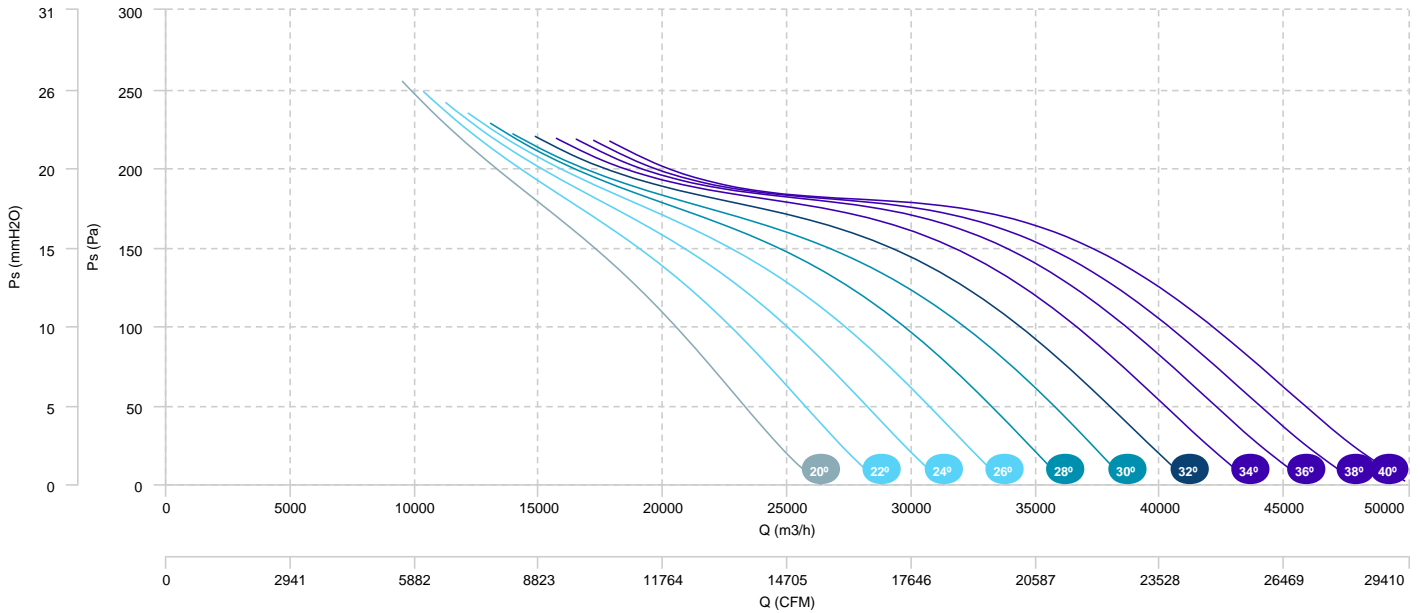

<p>HBF 112 T4/T8 5,5/1,1kW (A3:4) F400</p> <p>HBF 112 T4/T8 14/3,5kW (A3:4) F400</p>	<p>HBF 112 T4/T8 7,5/1,5kW (A3:4) F400</p> <p>HBF 112 T4/T8 17/4,3kW (A3:4) F400</p>	<p>HBF 112 T4/T8 11/3kW (A3:4) F400</p>
--	--	---

AIR FLOW - PRESSURE (4 poles)

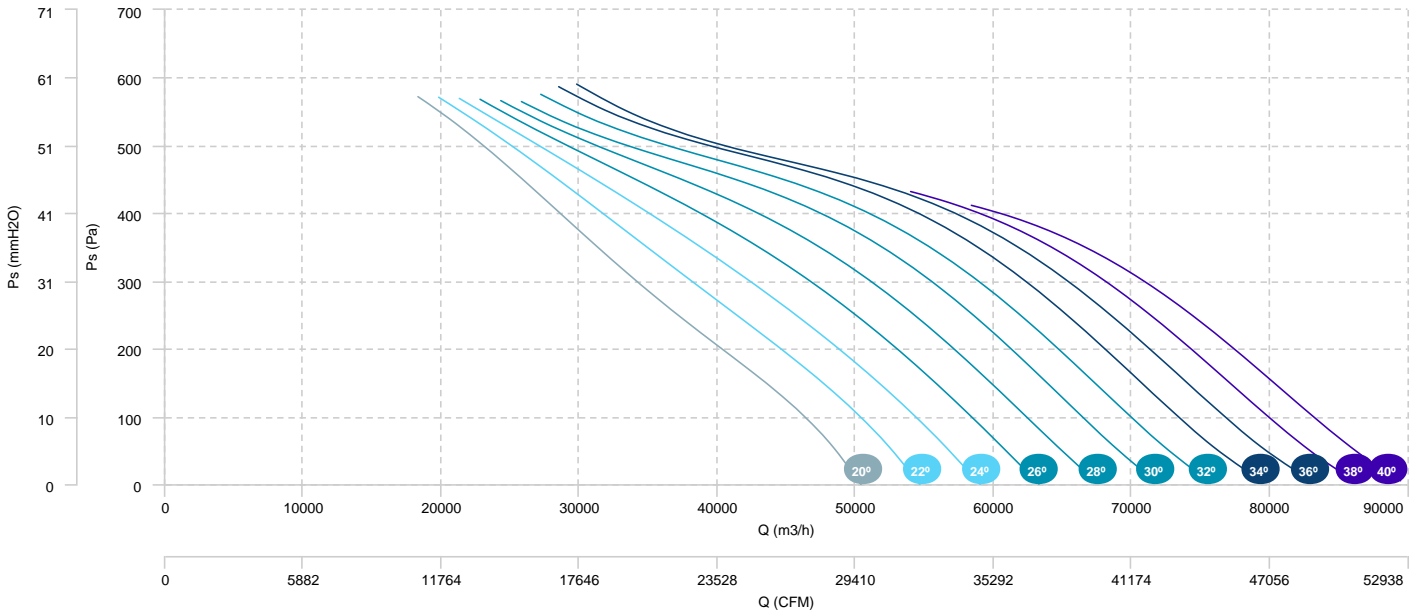

AIR FLOW - ABSORBED POWER (4 poles)

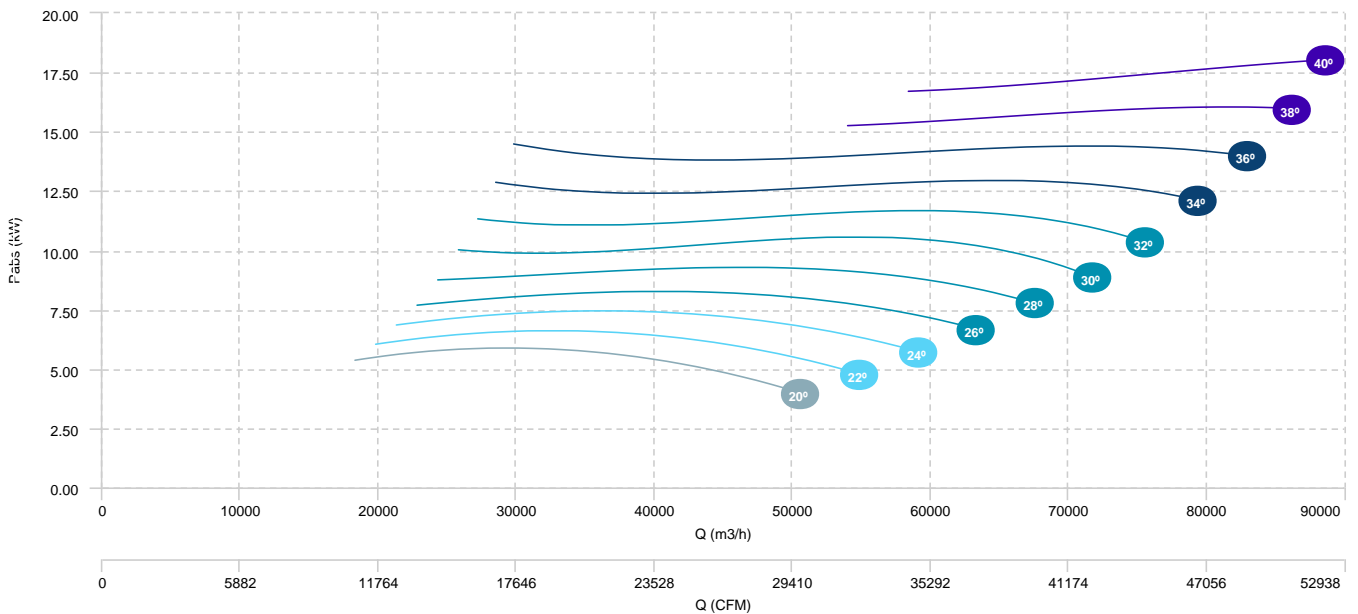

<p>HBF 112 T4/T8 5,5/1,1kW (A3:4) F400</p> <p>HBF 112 T4/T8 14/3,5kW (A3:4) F400</p>	<p>HBF 112 T4/T8 7,5/1,5kW (A3:4) F400</p> <p>HBF 112 T4/T8 17/4,3kW (A3:4) F400</p>	<p>HBF 112 T4/T8 11/3kW (A3:4) F400</p>
--	--	---

AIR FLOW - PRESSURE (8 poles)

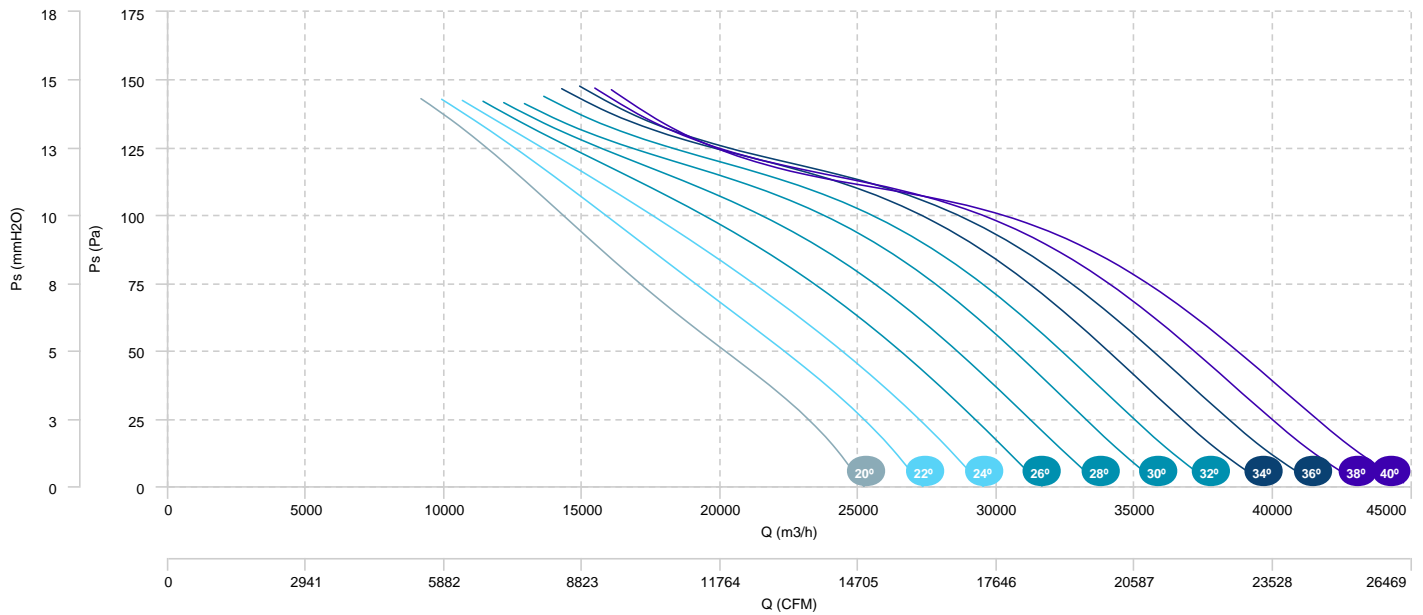

<p>HBF 125 T4 18,5kW (A3:8) F400</p> <p>HBF 125 T4 37kW (A3:8) F400</p>	<p>HBF 125 T4 22kW (A3:8) F400</p> <p>HBF 125 T4 45kW (A3:8) F400</p>	<p>HBF 125 T4 30kW (A3:8) F400</p>
---	---	------------------------------------

AIR FLOW - PRESSURE

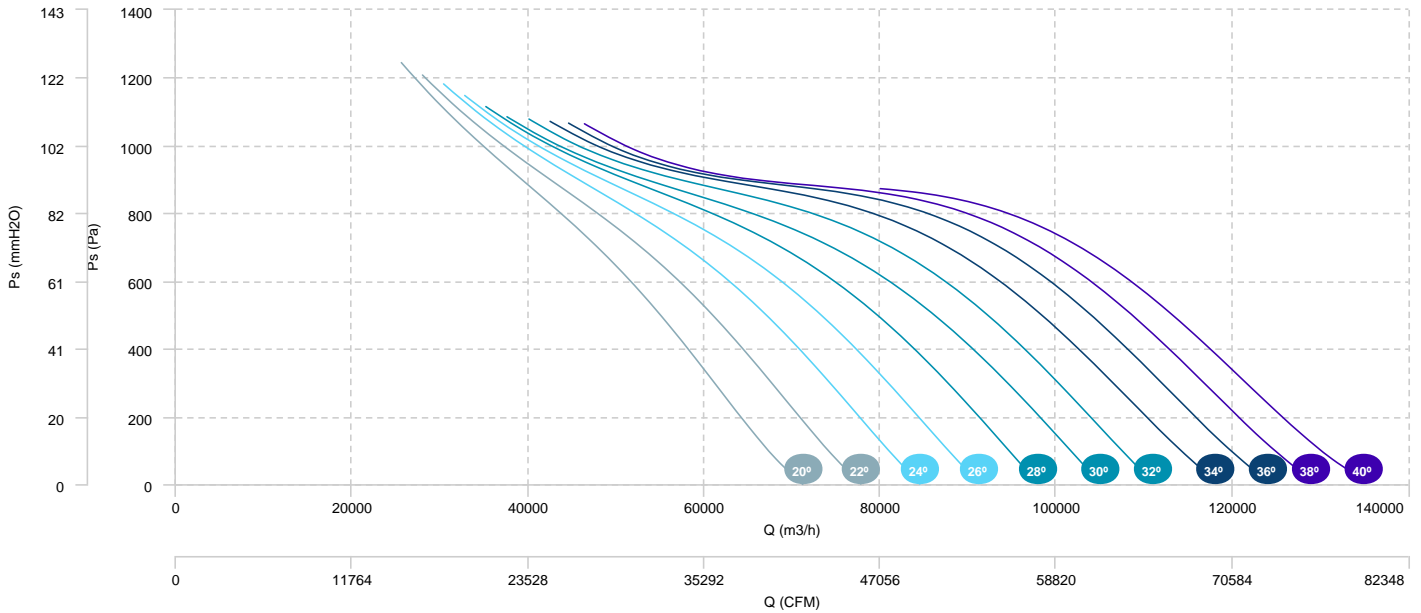

AIR FLOW - ABSORBED POWER

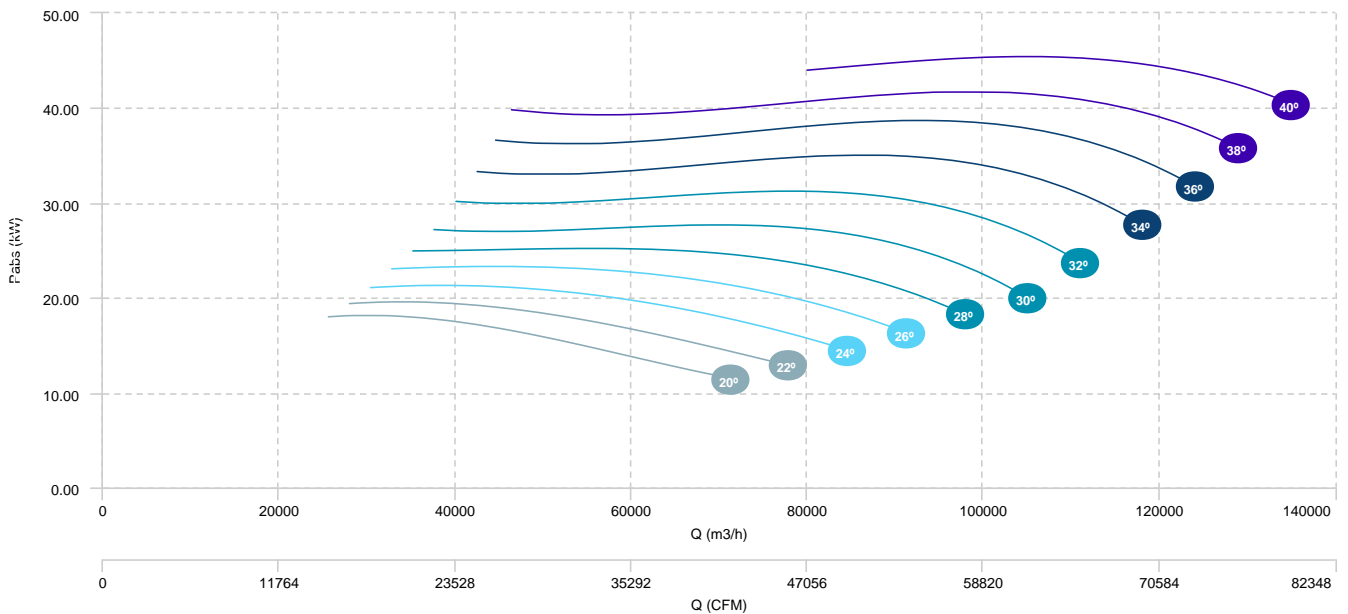

HBF 125 T4 11kW (A3:4) F400	HBF 125 T4 15kW (A3:4) F400	HBF 125 T4 18,5kW (A3:4) F400
HBF 125 T4 22kW (A3:4) F400	HBF 125 T4 30kW (A3:4) F400	

AIR FLOW - PRESSURE

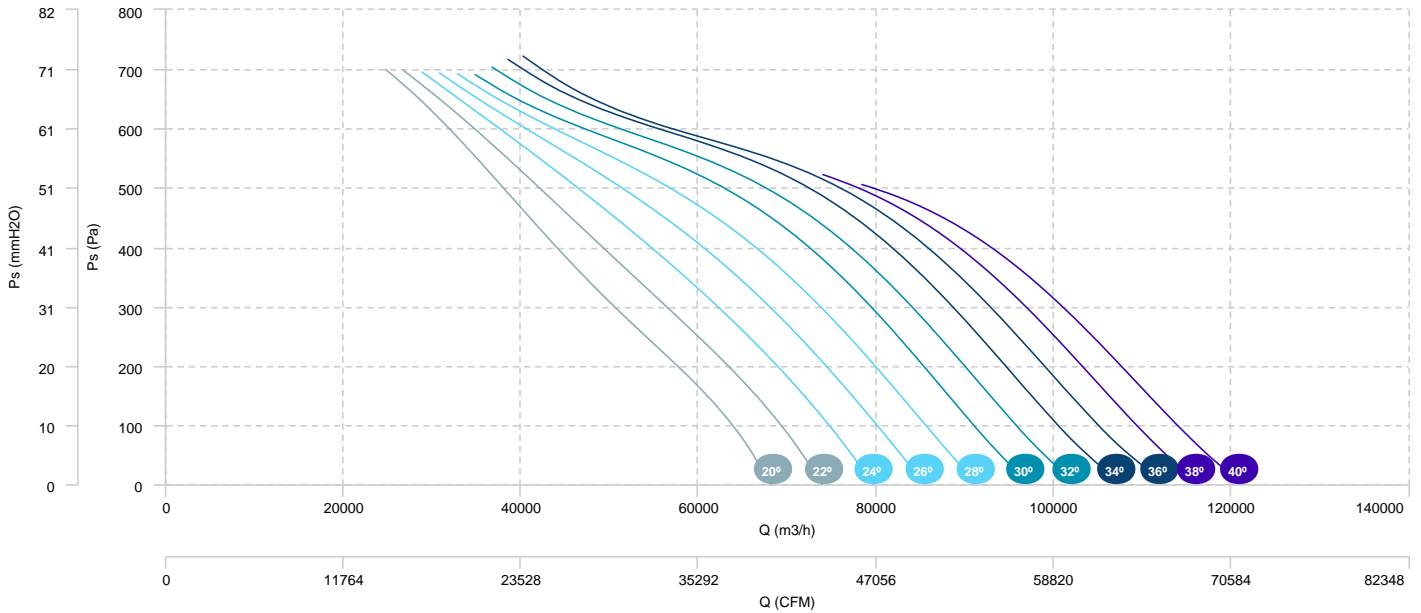

AIR FLOW - ABSORBED POWER

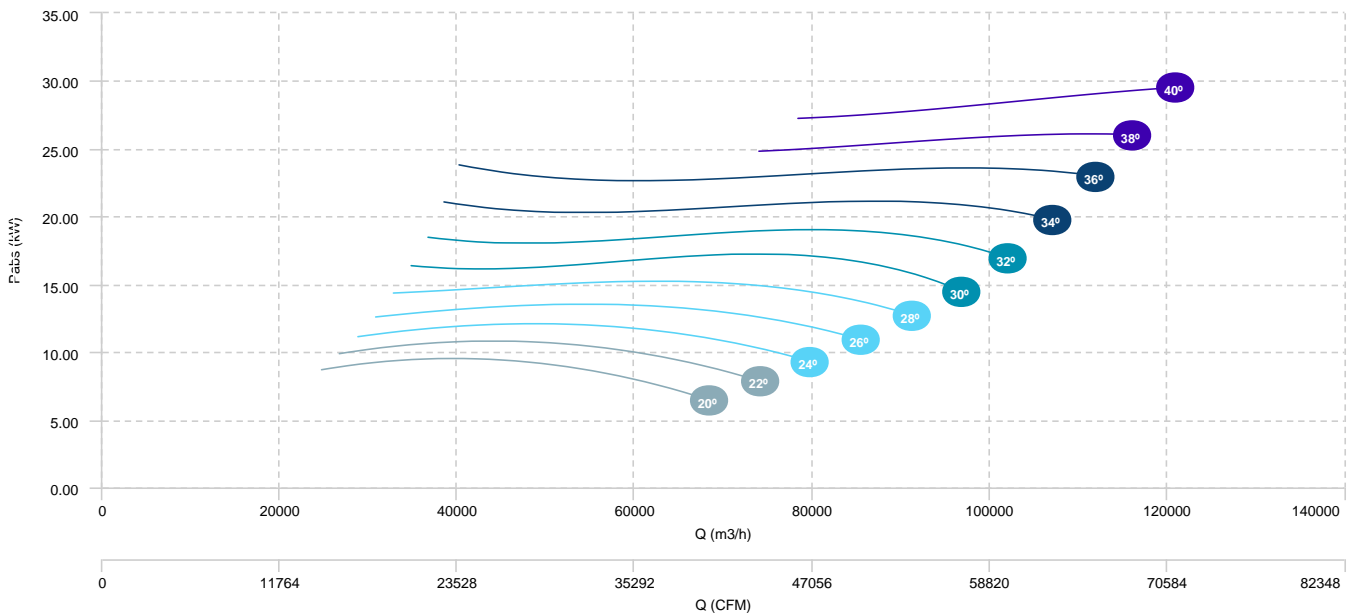

HBF 125 T6 3kW (A3:4) F400
 HBF 125 T6 7,5kW (A3:4) F400

HBF 125 T6 4kW (A3:4) F400

HBF 125 T6 5,5kW (A3:4) F400

AIR FLOW - PRESSURE

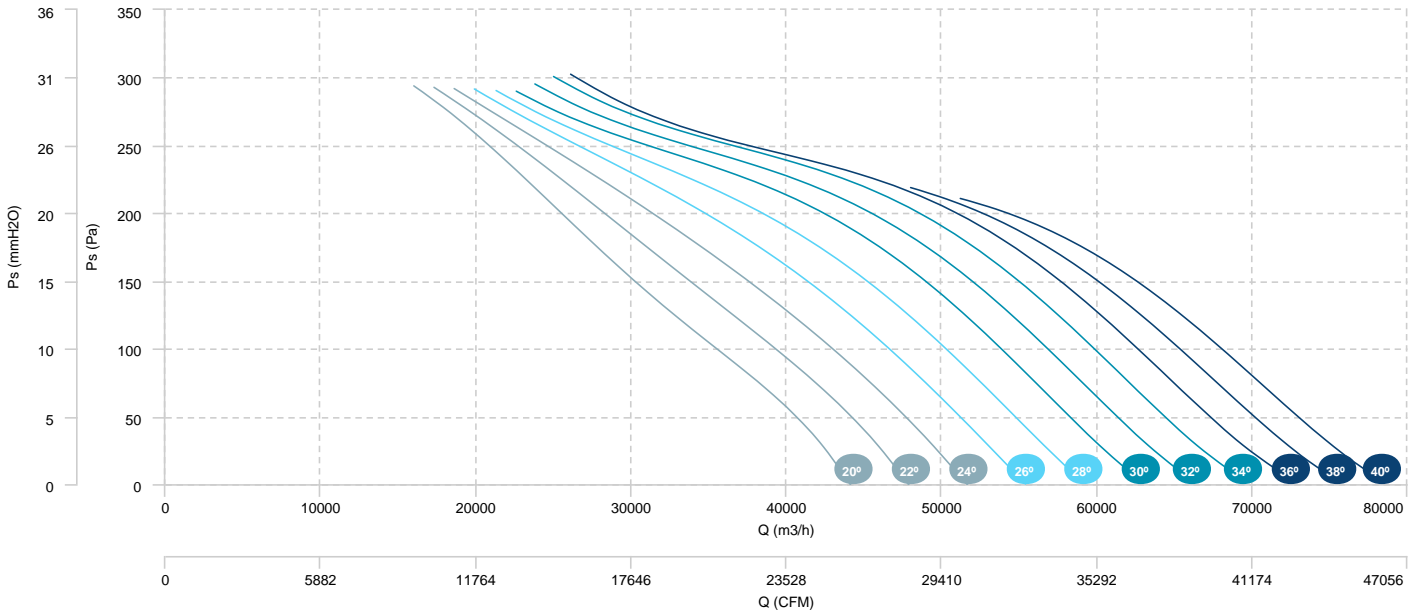

AIR FLOW - ABSORBED POWER

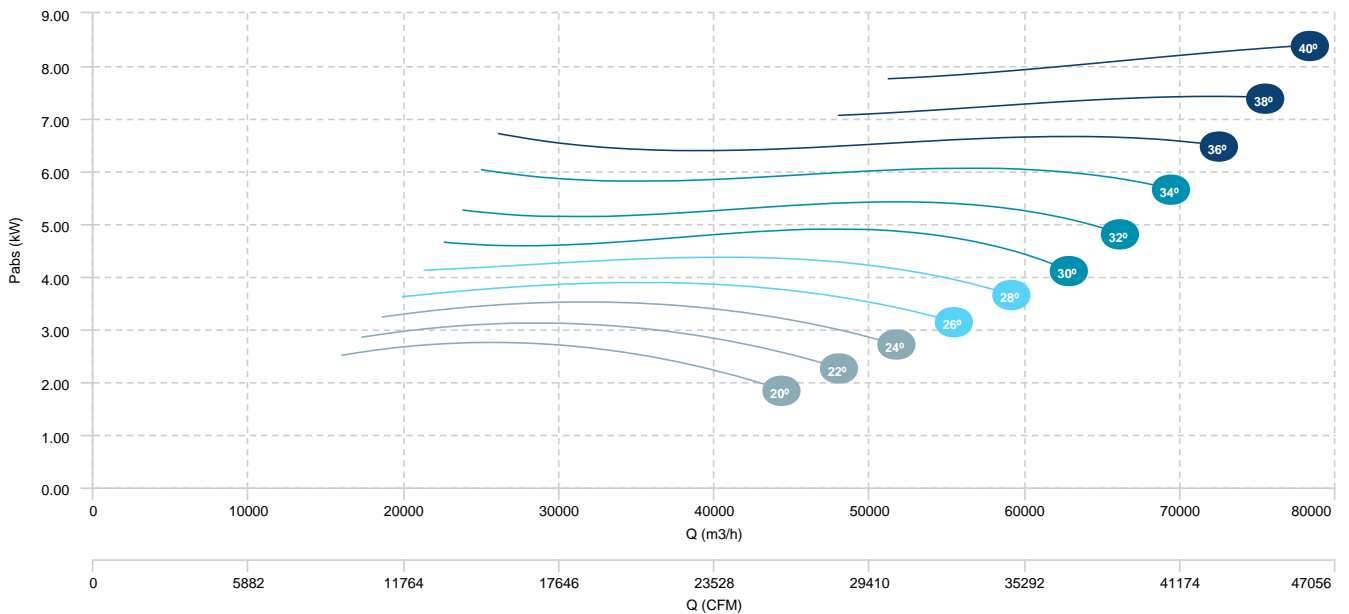

<p>HBF 125 T6 5,5kW (A3:8) F400</p> <p>HBF 125 T6 15kW (A3:8) F400</p>	<p>HBF 125 T6 7,5kW (A3:8) F400</p>	<p>HBF 125 T6 11kW (A3:8) F400</p>
--	-------------------------------------	------------------------------------

AIR FLOW - PRESSURE

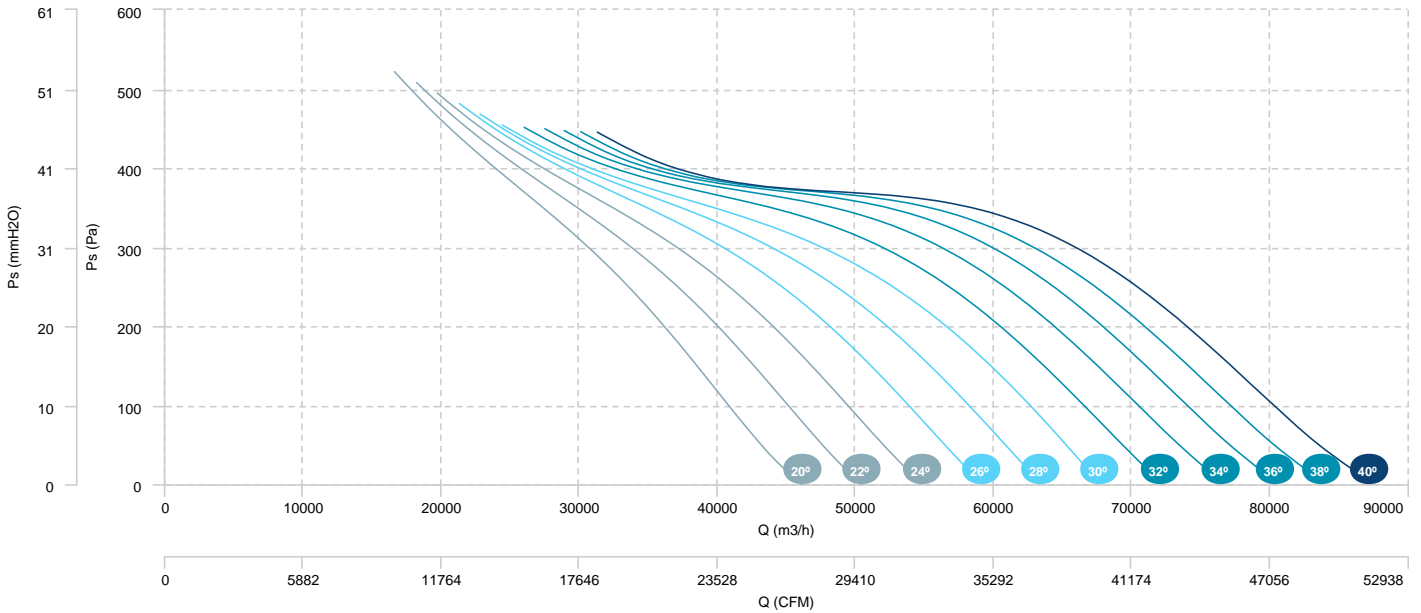

AIR FLOW - ABSORBED POWER

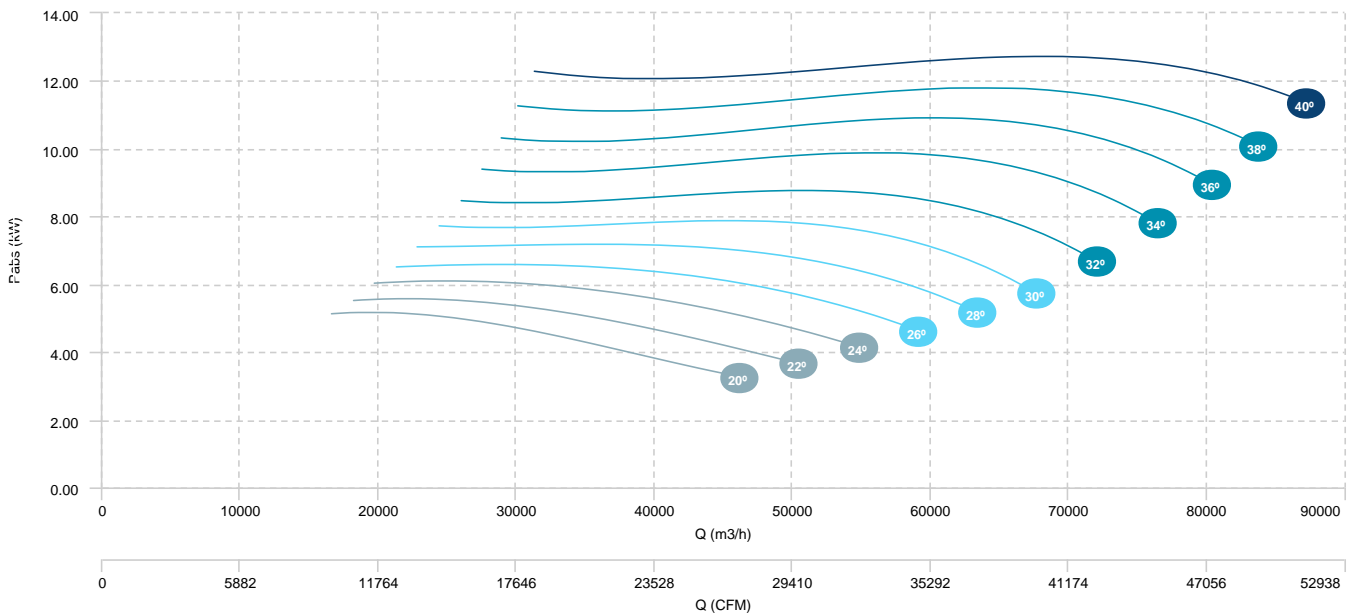

HBF 125 T4/T8 20/5kW (A3:8) F400
 HBF 125 T4/T8 44/11kW (A3:8) F400

HBF 125 T4/T8 28/6,5kW (A3:8) F400

HBF 125 T4/T8 37/9,2kW (A3:8) F400

AIR FLOW - PRESSURE (4 poles)

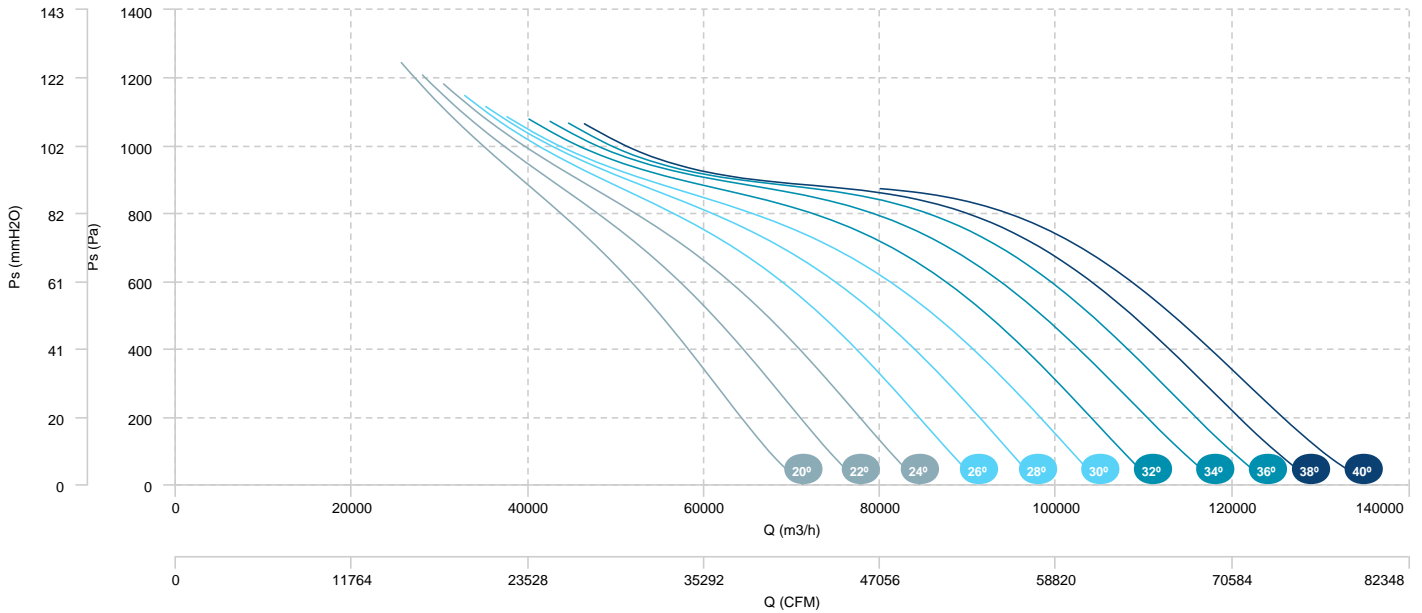

AIR FLOW - ABSORBED POWER (4 poles)

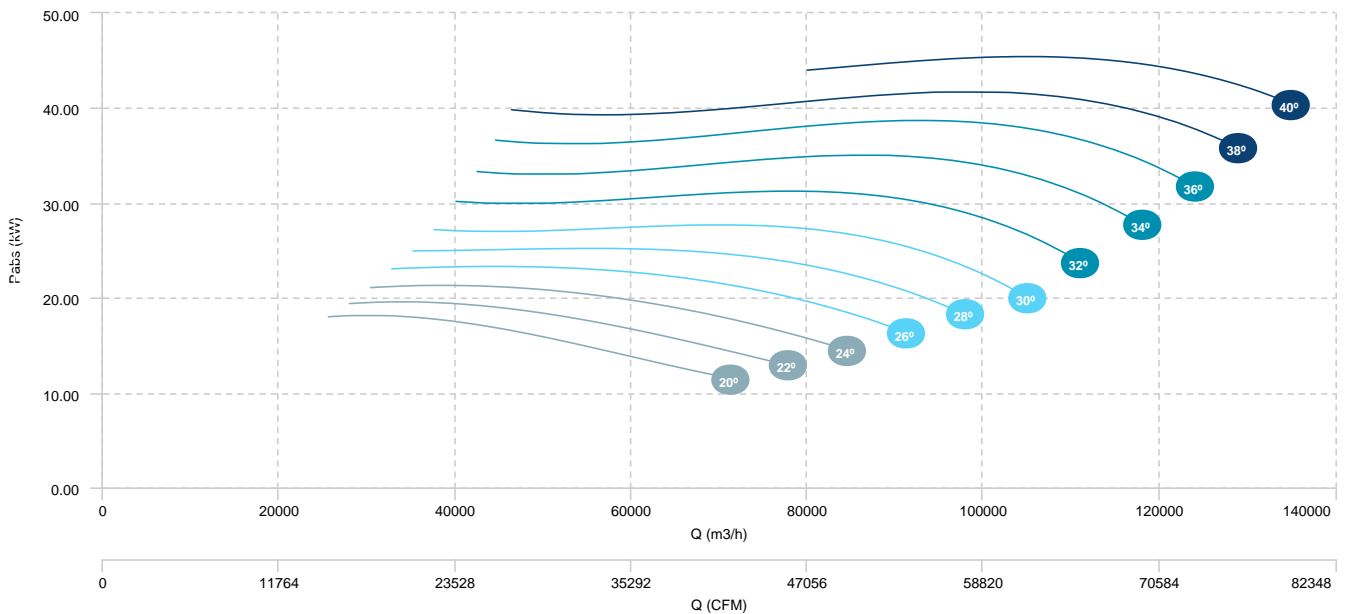

HBF 125 T4/T8 20/5kW (A3:8) F400

HBF 125 T4/T8 28/6,5kW (A3:8) F400

HBF 125 T4/T8 37/9,2kW (A3:8) F400

HBF 125 T4/T8 44/11kW (A3:8) F400

AIR FLOW - PRESSURE (8 poles)

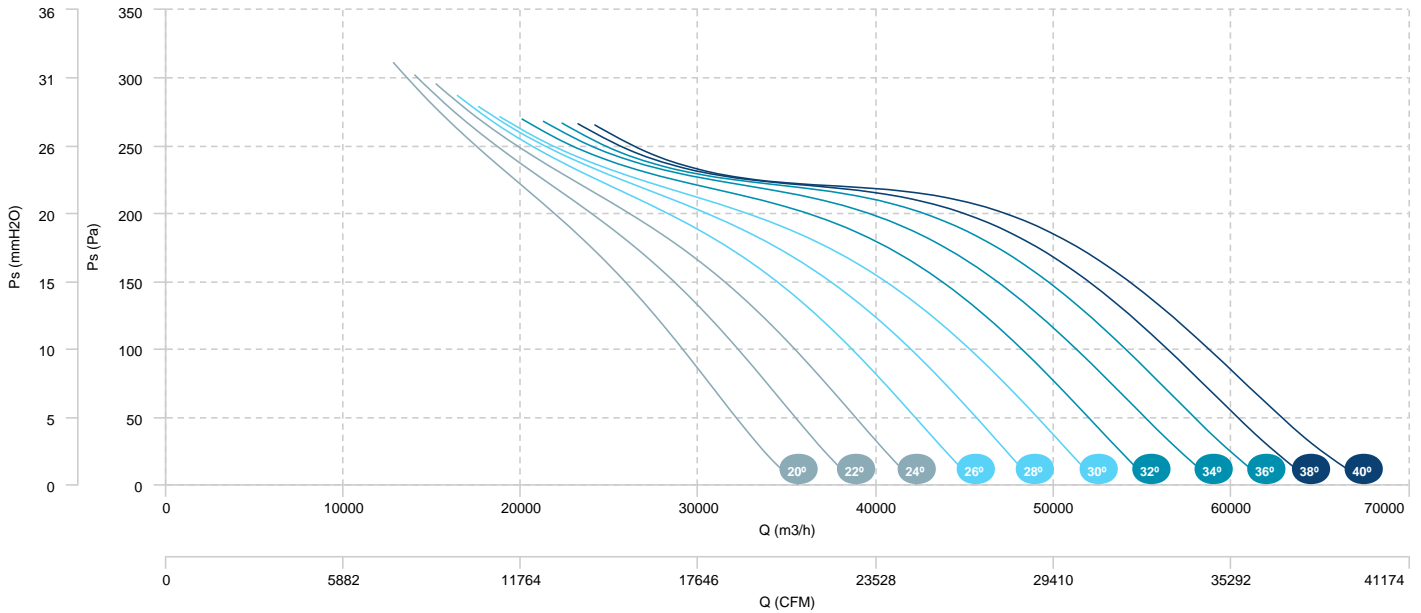

<p>HBF 125 T4/T8 11/3kW (A3:4) F400</p> <p>HBF 125 T4/T8 20/5kW (A3:4) F400</p>	<p>HBF 125 T4/T8 14/3,5kW (A3:4) F400</p> <p>HBF 125 T4/T8 28/6,5kW (A3:4) F400</p>	<p>HBF 125 T4/T8 17/4,3kW (A3:4) F400</p>
---	---	---

AIR FLOW - PRESSURE (4 poles)

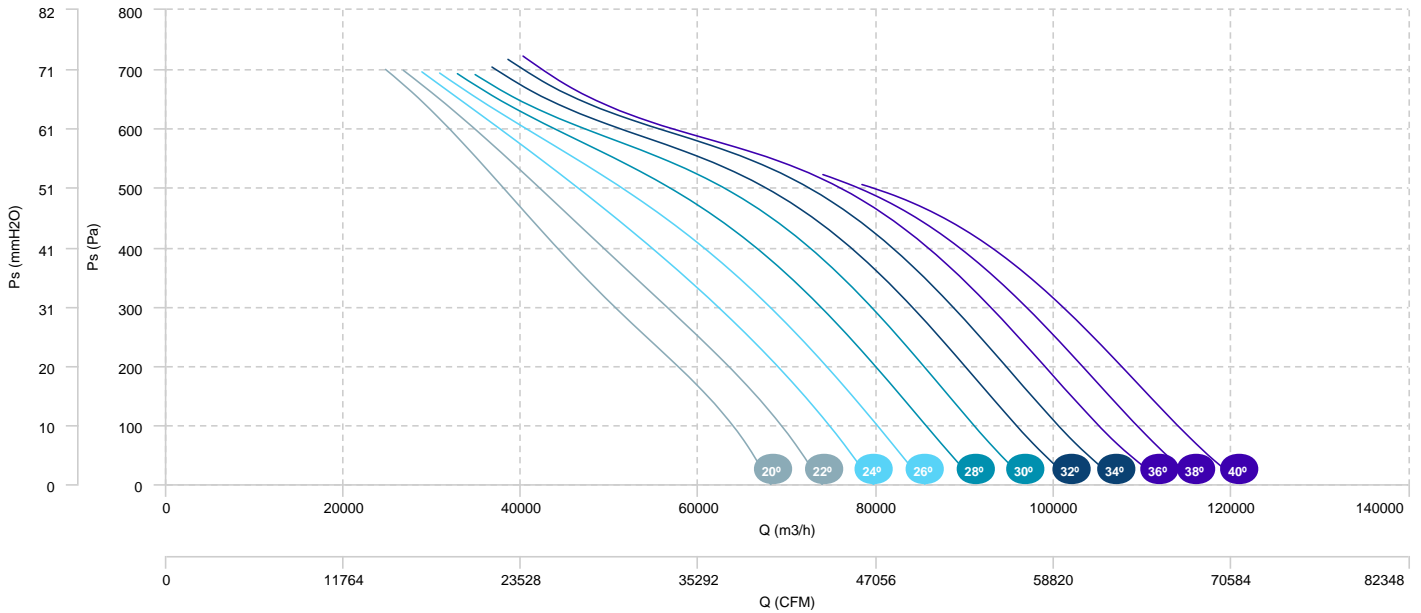

AIR FLOW - ABSORBED POWER (4 poles)

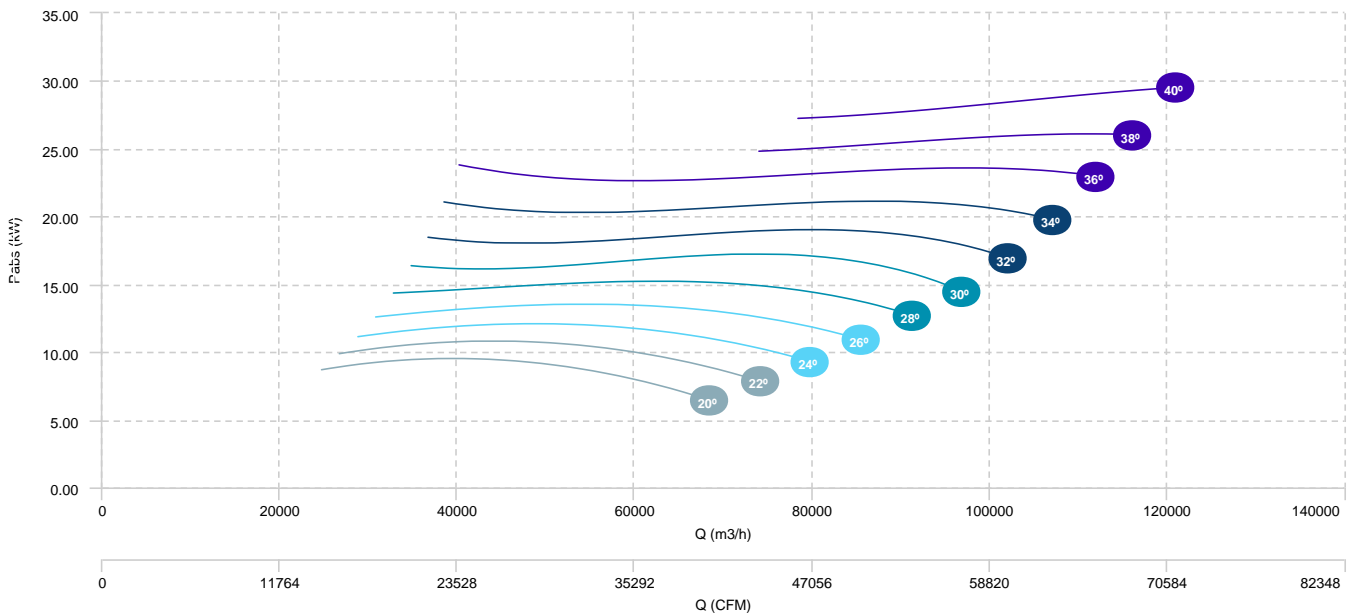

<p>HBF 125 T4/T8 11/3kW (A3:4) F400</p> <p>HBF 125 T4/T8 20/5kW (A3:4) F400</p>	<p>HBF 125 T4/T8 14/3,5kW (A3:4) F400</p> <p>HBF 125 T4/T8 28/6,5kW (A3:4) F400</p>	<p>HBF 125 T4/T8 17/4,3kW (A3:4) F400</p>
---	---	---

AIR FLOW - PRESSURE (8 poles)

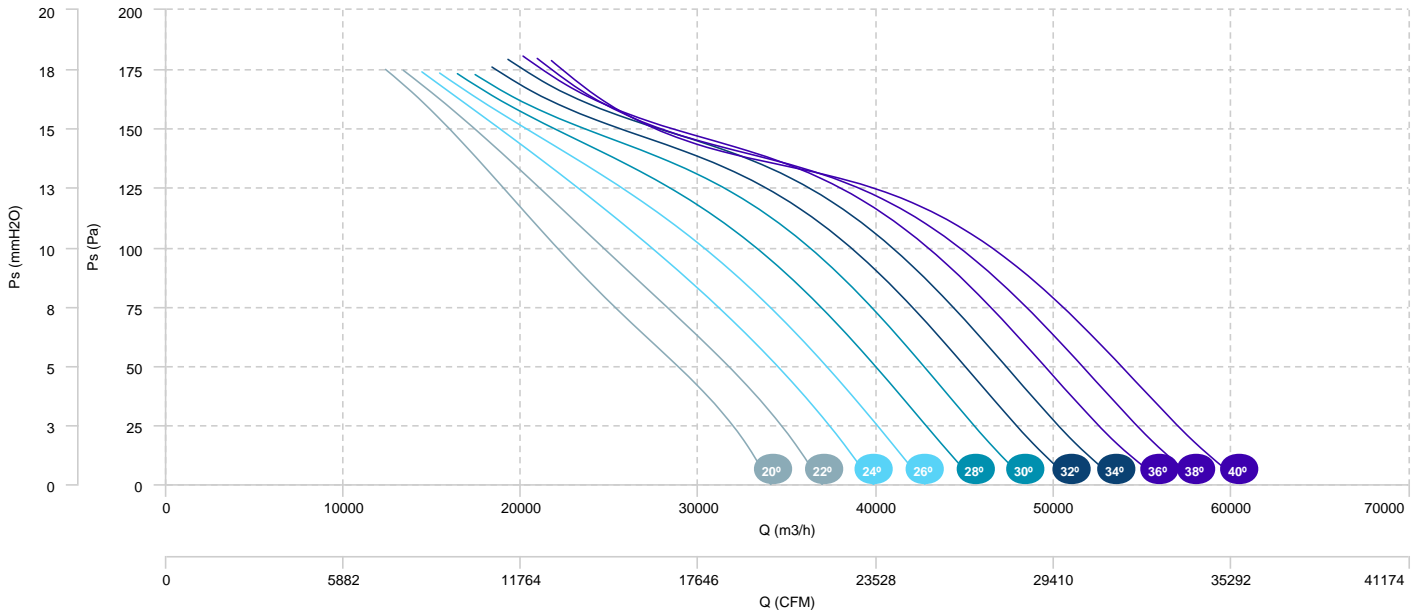

Dane akustyczne

Hałas / 4 poles

		Sound power Lw dB (A)								
Model		63 Hz	125 Hz	250 Hz	500 Hz	1000 Hz	2000 Hz	4000 Hz	8000 Hz	Total
HBF 45 T4 0,75kW (A5:6) F400 (40°)	Inlet	50	57	62	67	70	70	71	64	76
HBF 50 T4 0,75kW (A5:6) F400 (40°)	Inlet	53	60	65	69	72	71	72	66	78
HBF 56 T4 0,75kW (A5:6) F400 (25°)	Inlet	54	62	67	75	79	76	78	70	84
HBF 56 T4 0,75kW (A5:6) F400 (33°)	Inlet	54	61	66	75	75	76	79	70	83
HBF 56 T4 0,75kW (A5:6) F400 (30°)	Inlet	56	63	68	77	78	78	80	72	85
HBF 56 T4 1,1kW (A5:6) F400 (37°)	Inlet	54	61	66	75	74	76	78	69	82
HBF 56 T4 1,1kW (A5:6) F400 (35°)	Inlet	53	60	65	74	73	75	78	69	82
HBF 56 T4 1,5kW (A5:6) F400 (40°)	Inlet	56	63	68	76	75	76	79	70	83
HBF 56 T4 1,5kW (A5:6) F400 (43°)	Inlet	58	65	70	76	76	77	79	70	84
HBF 63 T4 0,75kW (A5:6) F400 (25°)	Inlet	57	66	71	80	80	79	80	75	86
HBF 63 T4 1,1kW (A5:6) F400 (30°)	Inlet	60	68	74	80	80	79	82	77	87
HBF 63 T4 1,5kW (A5:6) F400 (35°)	Inlet	59	67	72	75	76	76	79	73	83
HBF 63 T4 1,5kW (A5:6) F400 (33°)	Inlet	59	68	73	77	78	77	80	75	85
HBF 63 T4 2,2kW (A5:6) F400 (40°)	Inlet	60	67	72	77	78	78	80	73	85
HBF 63 T4 2,2kW (A5:6) F400 (37°)	Inlet	59	67	72	76	77	77	79	73	84
HBF 71 T4 0,75kW (A5:6) F400 (20°)	Inlet	55	66	71	86	85	82	84	76	91
HBF 71 T4 1,1kW (A5:6) F400 (25°)	Inlet	59	67	72	84	84	82	84	75	90
HBF 71 T4 1,5kW (A5:6) F400 (30°)	Inlet	61	68	73	82	82	83	84	73	89
HBF 71 T4 2,2kW (A5:6) F400 (35°)	Inlet	62	69	74	76	80	82	83	72	87
HBF 71 T4 2,2kW (A5:6) F400 (33°)	Inlet	62	69	74	79	81	83	84	73	88
HBF 71 T4 3kW (A5:6) F400 (40°)	Inlet	67	73	79	81	84	85	86	76	91
HBF 71 T4 3kW (A5:6) F400 (37°)	Inlet	65	71	77	79	82	84	85	74	89
HBF 80 T4 3kW (A5:6) F400 (35°)	Inlet	62	69	74	79	82	82	86	76	89
HBF 80 T4 3kW (A5:6) F400 (33°)	Inlet	63	70	75	81	85	84	88	80	91
HBF 80 T4 3kW (A5:6) F400 (30°)	Inlet	64	71	76	83	87	86	90	83	94
HBF 80 T4 4kW (A5:6) F400 (37°)	Inlet	64	71	76	80	83	83	86	76	90
HBF 80 T4 4kW (A5:6) F400 (40°)	Inlet	66	73	78	82	84	84	86	76	91
HBF 90 T4 3kW (A3:4) F400 (22°)	Inlet	61	69	74	83	87	87	86	77	92
HBF 90 T4 3kW (A3:4) F400 (20°)	Inlet	57	68	73	84	88	88	86	78	93
HBF 90 T4 4kW (A3:4) F400 (26°)	Inlet	64	71	76	83	85	85	84	76	91
HBF 90 T4 4kW (A3:4) F400 (24°)	Inlet	63	70	75	83	86	86	85	77	91
HBF 90 T4 5,5kW (A3:4) F400 (30°)	Inlet	66	73	78	83	83	83	83	75	89
HBF 90 T4 5,5kW (A3:4) F400 (28°)	Inlet	65	72	77	83	84	84	84	76	90
HBF 90 T4 5,5kW (A3:4) F400 (32°)	Inlet	66	73	78	82	83	83	83	75	89
HBF 90 T4 5,5kW (A3:8) F400 (22°)	Inlet	69	80	88	90	92	87	88	78	97
HBF 90 T4 5,5kW (A3:8) F400 (20°)	Inlet	69	81	90	91	93	87	88	78	98

Sound power Lw dB (A)

Model		63 Hz	125 Hz	250 Hz	500 Hz	1000 Hz	2000 Hz	4000 Hz	8000 Hz	Total
HBF 90 T4 5,5kW (A3:8) F400 (24°)	Inlet	69	79	86	89	91	88	88	78	96
HBF 90 T4 7,5kW (A3:4) F400 (34°)	Inlet	65	72	77	81	83	84	82	74	89
HBF 90 T4 7,5kW (A3:4) F400 (38°)	Inlet	67	74	79	82	85	84	83	76	91
HBF 90 T4 7,5kW (A3:4) F400 (36°)	Inlet	66	73	78	81	84	84	82	74	90
HBF 90 T4 7,5kW (A3:8) F400 (28°)	Inlet	70	76	82	87	89	88	87	79	94
HBF 90 T4 7,5kW (A3:8) F400 (26°)	Inlet	70	78	84	88	90	88	88	79	95
HBF 90 T4 11kW (A3:4) F400 (40°)	Inlet	68	75	80	83	87	85	84	77	91
HBF 90 T4 11kW (A3:8) F400 (36°)	Inlet	67	74	79	83	87	87	85	77	92
HBF 90 T4 11kW (A3:8) F400 (34°)	Inlet	67	74	79	84	87	87	85	77	92
HBF 90 T4 11kW (A3:8) F400 (32°)	Inlet	67	74	79	85	87	87	86	78	93
HBF 90 T4 11kW (A3:8) F400 (30°)	Inlet	68	75	80	86	88	88	87	79	94
HBF 90 T4 15kW (A3:8) F400 (40°)	Inlet	71	78	83	84	88	87	84	78	93
HBF 90 T4 15kW (A3:8) F400 (38°)	Inlet	69	76	81	84	87	87	84	77	92
HBF 100 T4 5,5kW (A3:4) F400 (26°)	Inlet	67	75	81	87	90	91	93	88	97
HBF 100 T4 5,5kW (A3:4) F400 (24°)	Inlet	67	76	81	87	91	92	93	89	98
HBF 100 T4 5,5kW (A3:4) F400 (22°)	Inlet	66	76	82	88	91	92	93	90	98
HBF 100 T4 5,5kW (A3:4) F400 (20°)	Inlet	66	76	81	88	91	92	93	90	98
HBF 100 T4 7,5kW (A3:4) F400 (30°)	Inlet	68	74	81	86	90	91	93	86	97
HBF 100 T4 7,5kW (A3:4) F400 (28°)	Inlet	67	75	81	86	90	91	93	87	97
HBF 100 T4 7,5kW (A3:8) F400 (20°)	Inlet	72	81	92	102	100	99	100	95	107
HBF 100 T4 11kW (A3:4) F400 (38°)	Inlet	68	74	81	86	89	90	92	85	96
HBF 100 T4 11kW (A3:4) F400 (36°)	Inlet	69	73	81	86	88	90	91	85	96
HBF 100 T4 11kW (A3:4) F400 (34°)	Inlet	69	73	81	85	88	90	91	85	96
HBF 100 T4 11kW (A3:4) F400 (32°)	Inlet	68	74	81	86	89	90	92	86	96
HBF 100 T4 11kW (A3:8) F400 (28°)	Inlet	72	79	87	93	96	95	96	91	102
HBF 100 T4 11kW (A3:8) F400 (24°)	Inlet	72	79	89	97	97	97	98	93	104
HBF 100 T4 11kW (A3:8) F400 (22°)	Inlet	72	80	91	100	99	98	99	94	106
HBF 100 T4 11kW (A3:8) F400 (26°)	Inlet	72	79	88	95	96	96	97	92	103
HBF 100 T4 15kW (A3:4) F400 (40°)	Inlet	68	75	81	87	90	91	92	86	97
HBF 100 T4 15kW (A3:8) F400 (34°)	Inlet	71	78	83	88	92	93	94	88	99
HBF 100 T4 15kW (A3:8) F400 (32°)	Inlet	71	79	84	90	93	94	95	89	100
HBF 100 T4 15kW (A3:8) F400 (30°)	Inlet	72	79	86	91	95	95	96	90	101
HBF 100 T4 18,5kW (A3:8) F400 (38°)	Inlet	71	78	83	88	92	94	94	88	99
HBF 100 T4 18,5kW (A3:8) F400 (36°)	Inlet	70	77	82	87	91	93	94	87	99
HBF 100 T4 22kW (A3:8) F400 (40°)	Inlet	71	79	84	89	92	94	95	89	100
HBF 112 T4 5,5kW (A3:4) F400 (20°)	Inlet	66	78	83	90	94	94	96	92	101
HBF 112 T4 7,5kW (A3:4) F400 (22°)	Inlet	68	79	84	90	94	95	96	92	102
HBF 112 T4 7,5kW (A3:4) F400 (24°)	Inlet	69	78	83	90	93	94	96	91	101
HBF 112 T4 11kW (A3:4) F400 (32°)	Inlet	70	77	82	87	91	92	94	87	98

Sound power Lw dB (A)

Model		63 Hz	125 Hz	250 Hz	500 Hz	1000 Hz	2000 Hz	4000 Hz	8000 Hz	Total
HBF 112 T4 11kW (A3:4) F400 (30°)	Inlet	71	78	83	88	92	93	94	88	99
HBF 112 T4 11kW (A3:4) F400 (28°)	Inlet	71	78	83	89	92	93	95	89	99
HBF 112 T4 11kW (A3:4) F400 (26°)	Inlet	70	78	83	89	93	94	95	90	100
HBF 112 T4 11kW (A3:8) F400 (22°)	Inlet	73	81	91	99	100	102	102	96	107
HBF 112 T4 11kW (A3:8) F400 (20°)	Inlet	73	82	92	101	101	103	103	97	109
HBF 112 T4 15kW (A3:4) F400 (38°)	Inlet	71	77	83	88	91	92	93	87	98
HBF 112 T4 15kW (A3:4) F400 (34°)	Inlet	70	76	82	87	90	92	93	86	98
HBF 112 T4 15kW (A3:4) F400 (36°)	Inlet	71	76	83	87	90	92	93	86	98
HBF 112 T4 15kW (A3:8) F400 (26°)	Inlet	74	81	89	96	98	100	100	94	106
HBF 112 T4 15kW (A3:8) F400 (24°)	Inlet	73	81	90	97	99	101	101	95	106
HBF 112 T4 15kW (A3:8) F400 (28°)	Inlet	74	81	88	94	98	99	99	94	105
HBF 112 T4 18,5kW (A3:4) F400 (40°)	Inlet	72	79	84	89	91	93	94	87	99
HBF 112 T4 18,5kW (A3:8) F400 (32°)	Inlet	74	81	86	91	96	97	97	91	103
HBF 112 T4 18,5kW (A3:8) F400 (30°)	Inlet	74	80	87	93	97	99	99	93	104
HBF 112 T4 22kW (A3:8) F400 (34°)	Inlet	73	80	85	90	94	96	96	89	101
HBF 112 T4 22kW (A3:8) F400 (36°)	Inlet	73	80	85	90	93	95	95	89	101
HBF 112 T4 30kW (A3:8) F400 (40°)	Inlet	74	81	86	90	94	96	95	90	101
HBF 112 T4 30kW (A3:8) F400 (38°)	Inlet	73	80	85	90	94	96	95	89	101
HBF 125 T4 11kW (A3:4) F400 (22°)	Inlet	75	86	91	98	102	103	105	101	109
HBF 125 T4 11kW (A3:4) F400 (20°)	Inlet	72	85	90	98	102	102	104	101	109
HBF 125 T4 15kW (A3:4) F400 (28°)	Inlet	75	82	87	93	96	98	99	93	104
HBF 125 T4 15kW (A3:4) F400 (26°)	Inlet	76	84	89	94	98	99	101	95	106
HBF 125 T4 15kW (A3:4) F400 (24°)	Inlet	75	85	90	96	100	101	103	98	107
HBF 125 T4 18,5kW (A3:4) F400 (32°)	Inlet	74	81	86	90	94	96	96	90	102
HBF 125 T4 18,5kW (A3:4) F400 (30°)	Inlet	74	81	86	91	95	96	97	91	102
HBF 125 T4 18,5kW (A3:8) F400 (22°)	Inlet	79	86	93	102	107	110	109	104	114
HBF 125 T4 18,5kW (A3:8) F400 (20°)	Inlet	78	86	93	103	108	111	110	105	115
HBF 125 T4 22kW (A3:4) F400 (36°)	Inlet	74	81	86	90	93	95	96	88	101
HBF 125 T4 22kW (A3:4) F400 (34°)	Inlet	73	80	85	90	93	95	96	88	101
HBF 125 T4 22kW (A3:8) F400 (24°)	Inlet	78	85	92	100	106	108	108	102	113
HBF 125 T4 22kW (A3:8) F400 (26°)	Inlet	78	85	91	98	104	106	106	100	111
HBF 125 T4 30kW (A3:4) F400 (40°)	Inlet	75	82	87	91	93	96	96	89	102
HBF 125 T4 30kW (A3:4) F400 (38°)	Inlet	74	81	86	91	93	95	96	89	101
HBF 125 T4 30kW (A3:8) F400 (30°)	Inlet	77	83	90	96	101	103	104	97	108
HBF 125 T4 30kW (A3:8) F400 (28°)	Inlet	78	84	91	97	102	105	105	98	110
HBF 125 T4 30kW (A3:8) F400 (32°)	Inlet	77	83	89	95	99	102	102	94	107
HBF 125 T4 37kW (A3:8) F400 (36°)	Inlet	77	83	89	93	96	98	98	91	104
HBF 125 T4 37kW (A3:8) F400 (34°)	Inlet	77	83	89	94	97	99	100	92	105
HBF 125 T4 45kW (A3:8) F400 (40°)	Inlet	76	83	88	93	96	98	97	90	103

Sound power Lw dB (A)

Model		63 Hz	125 Hz	250 Hz	500 Hz	1000 Hz	2000 Hz	4000 Hz	8000 Hz	Total
HBF 125 T4 45kW (A3:8) F400 (38°)	Inlet	76	83	88	93	96	98	97	91	104

Hałas / 6 poles
Sound power Lw dB (A)

Model		63 Hz	125 Hz	250 Hz	500 Hz	1000 Hz	2000 Hz	4000 Hz	8000 Hz	Total
HBF 50 T6 0,75kW (A5:6) F400 (40°)	Inlet	44	51	56	60	63	62	64	57	69
HBF 56 T6 0,75kW (A5:6) F400 (40°)	Inlet	47	54	59	67	66	67	70	61	74
HBF 63 T6 0,75kW (A5:6) F400 (40°)	Inlet	51	58	63	68	69	69	71	64	76
HBF 71 T6 0,75kW (A5:6) F400 (40°)	Inlet	59	65	71	73	76	77	78	68	83
HBF 71 T6 0,75kW (A5:6) F400 (37°)	Inlet	56	63	68	70	73	75	76	65	81
HBF 71 T6 0,75kW (A5:6) F400 (35°)	Inlet	54	61	66	67	71	73	74	63	79
HBF 80 T6 0,75kW (A5:6) F400 (30°)	Inlet	55	62	67	74	78	77	81	74	85
HBF 80 T6 1,1kW (A5:6) F400 (33°)	Inlet	54	61	66	72	76	75	79	71	83
HBF 80 T6 1,1kW (A5:6) F400 (35°)	Inlet	53	60	65	70	73	74	77	67	81
HBF 80 T6 1,5kW (A5:6) F400 (37°)	Inlet	55	62	67	71	74	75	77	68	81
HBF 80 T6 1,5kW (A5:6) F400 (40°)	Inlet	57	64	69	73	75	76	77	68	82
HBF 80 T6 2,2kW (A5:6) F400 (43°)	Inlet	58	65	70	74	76	76	77	68	82
HBF 90 T6 1,5kW (A3:4) F400 (20°)	Inlet	47	58	63	74	78	78	77	69	83
HBF 90 T6 1,5kW (A3:4) F400 (26°)	Inlet	55	62	67	74	75	75	75	67	81
HBF 90 T6 1,5kW (A3:4) F400 (22°)	Inlet	51	60	65	74	77	77	76	68	83
HBF 90 T6 1,5kW (A3:4) F400 (30°)	Inlet	57	64	69	73	73	73	74	66	80
HBF 90 T6 1,5kW (A3:4) F400 (24°)	Inlet	54	61	66	74	76	76	76	67	82
HBF 90 T6 1,5kW (A3:4) F400 (32°)	Inlet	57	64	69	73	74	74	73	65	80
HBF 90 T6 1,5kW (A3:4) F400 (28°)	Inlet	56	63	68	73	74	74	74	66	81
HBF 90 T6 1,5kW (A3:8) F400 (24°)	Inlet	60	69	77	80	82	78	78	69	86
HBF 90 T6 1,5kW (A3:8) F400 (22°)	Inlet	60	71	79	81	83	78	78	69	87
HBF 90 T6 1,5kW (A3:8) F400 (20°)	Inlet	60	72	81	82	84	78	79	69	88
HBF 90 T6 2,2kW (A3:4) F400 (36°)	Inlet	56	63	68	72	75	75	73	65	80
HBF 90 T6 2,2kW (A3:4) F400 (40°)	Inlet	59	66	71	73	77	75	74	67	82
HBF 90 T6 2,2kW (A3:4) F400 (38°)	Inlet	58	65	70	73	76	75	74	66	81
HBF 90 T6 2,2kW (A3:4) F400 (34°)	Inlet	56	63	68	72	74	74	73	65	80
HBF 90 T6 2,2kW (A3:8) F400 (30°)	Inlet	59	66	71	77	79	79	78	70	84
HBF 90 T6 2,2kW (A3:8) F400 (28°)	Inlet	60	67	73	78	80	78	78	70	85
HBF 90 T6 2,2kW (A3:8) F400 (26°)	Inlet	60	68	75	79	81	78	78	69	86
HBF 90 T6 3kW (A3:8) F400 (36°)	Inlet	58	65	70	74	77	77	75	68	83
HBF 90 T6 3kW (A3:8) F400 (34°)	Inlet	57	64	69	74	77	78	76	68	83
HBF 90 T6 3kW (A3:8) F400 (32°)	Inlet	58	65	70	76	78	78	77	69	84
HBF 90 T6 4kW (A3:8) F400 (40°)	Inlet	61	68	73	75	79	78	75	68	84

Sound power Lw dB (A)

Model		63 Hz	125 Hz	250 Hz	500 Hz	1000 Hz	2000 Hz	4000 Hz	8000 Hz	Total
HBF 90 T6 4kW (A3:8) F400 (38°)	Inlet	59	66	71	74	78	78	75	68	83
HBF 100 T6 1,5kW (A3:4) F400 (26°)	Inlet	57	66	71	77	81	82	83	78	88
HBF 100 T6 1,5kW (A3:4) F400 (20°)	Inlet	56	67	72	78	82	83	84	81	89
HBF 100 T6 1,5kW (A3:4) F400 (24°)	Inlet	57	66	72	78	82	82	84	79	89
HBF 100 T6 1,5kW (A3:4) F400 (22°)	Inlet	57	67	72	78	82	83	84	80	89
HBF 100 T6 2,2kW (A3:4) F400 (26°)	Inlet	57	66	71	77	81	82	83	78	88
HBF 100 T6 2,2kW (A3:4) F400 (20°)	Inlet	56	67	72	78	82	83	84	81	89
HBF 100 T6 2,2kW (A3:4) F400 (32°)	Inlet	59	64	71	76	79	81	83	76	87
HBF 100 T6 2,2kW (A3:4) F400 (30°)	Inlet	58	65	71	77	80	81	83	77	87
HBF 100 T6 2,2kW (A3:4) F400 (28°)	Inlet	58	65	71	77	81	81	83	78	88
HBF 100 T6 2,2kW (A3:4) F400 (24°)	Inlet	57	66	72	78	82	82	84	79	89
HBF 100 T6 2,2kW (A3:4) F400 (22°)	Inlet	57	67	72	78	82	83	84	80	89
HBF 100 T6 2,2kW (A3:8) F400 (22°)	Inlet	63	71	82	90	89	88	89	85	96
HBF 100 T6 2,2kW (A3:8) F400 (20°)	Inlet	63	71	83	92	91	89	90	86	97
HBF 100 T6 3kW (A3:4) F400 (38°)	Inlet	59	65	72	77	80	81	82	76	87
HBF 100 T6 3kW (A3:4) F400 (34°)	Inlet	59	63	71	76	79	80	82	76	86
HBF 100 T6 3kW (A3:4) F400 (36°)	Inlet	59	64	71	76	79	80	82	76	86
HBF 100 T6 3kW (A3:8) F400 (24°)	Inlet	62	70	80	88	88	87	88	83	94
HBF 100 T6 3kW (A3:8) F400 (28°)	Inlet	62	70	78	84	86	86	87	81	92
HBF 100 T6 3kW (A3:8) F400 (26°)	Inlet	62	70	79	86	87	87	87	82	93
HBF 100 T6 4kW (A3:4) F400 (40°)	Inlet	59	66	72	77	81	81	83	76	87
HBF 100 T6 4kW (A3:8) F400 (34°)	Inlet	61	68	73	78	82	84	85	78	89
HBF 100 T6 4kW (A3:8) F400 (32°)	Inlet	62	69	75	80	84	85	85	79	90
HBF 100 T6 4kW (A3:8) F400 (30°)	Inlet	62	69	77	82	85	86	86	80	92
HBF 100 T6 5,5kW (A3:8) F400 (36°)	Inlet	61	68	73	78	82	84	84	78	89
HBF 100 T6 5,5kW (A3:8) F400 (40°)	Inlet	62	69	74	79	83	85	85	79	90
HBF 100 T6 5,5kW (A3:8) F400 (38°)	Inlet	61	68	73	79	82	84	85	79	90
HBF 112 T6 2,2kW (A3:4) F400 (26°)	Inlet	60	69	74	80	83	84	86	80	90
HBF 112 T6 2,2kW (A3:4) F400 (24°)	Inlet	59	69	74	80	84	85	86	81	91
HBF 112 T6 2,2kW (A3:4) F400 (22°)	Inlet	58	69	74	81	85	85	87	82	92
HBF 112 T6 2,2kW (A3:4) F400 (20°)	Inlet	56	68	73	80	84	85	87	82	91
HBF 112 T6 3kW (A3:4) F400 (28°)	Inlet	61	68	73	79	83	84	85	79	90
HBF 112 T6 3kW (A3:4) F400 (32°)	Inlet	61	67	73	78	81	83	84	78	89
HBF 112 T6 3kW (A3:4) F400 (30°)	Inlet	61	68	73	79	82	83	85	78	89
HBF 112 T6 3kW (A3:8) F400 (22°)	Inlet	64	72	81	89	90	92	92	87	98
HBF 112 T6 3kW (A3:8) F400 (20°)	Inlet	64	72	82	91	91	93	93	88	99
HBF 112 T6 4kW (A3:4) F400 (38°)	Inlet	62	68	74	78	81	83	84	77	89
HBF 112 T6 4kW (A3:4) F400 (36°)	Inlet	61	67	73	78	81	82	84	77	88
HBF 112 T6 4kW (A3:4) F400 (34°)	Inlet	61	66	73	78	81	82	84	77	88

Sound power Lw dB (A)

Model		63 Hz	125 Hz	250 Hz	500 Hz	1000 Hz	2000 Hz	4000 Hz	8000 Hz	Total
HBF 112 T6 4kW (A3:8) F400 (28°)	Inlet	64	71	79	85	89	90	90	84	95
HBF 112 T6 4kW (A3:8) F400 (26°)	Inlet	64	71	79	86	89	90	90	85	96
HBF 112 T6 4kW (A3:8) F400 (24°)	Inlet	64	71	80	88	90	91	91	86	96
HBF 112 T6 5,5kW (A3:4) F400 (40°)	Inlet	63	69	75	79	82	84	84	78	89
HBF 112 T6 5,5kW (A3:8) F400 (30°)	Inlet	65	71	78	83	88	89	89	84	94
HBF 112 T6 5,5kW (A3:8) F400 (34°)	Inlet	64	71	76	81	84	86	87	80	92
HBF 112 T6 5,5kW (A3:8) F400 (32°)	Inlet	64	71	77	82	86	88	88	82	93
HBF 112 T6 7,5kW (A3:8) F400 (38°)	Inlet	64	71	76	81	84	86	86	80	91
HBF 112 T6 7,5kW (A3:8) F400 (36°)	Inlet	63	70	75	80	84	86	86	79	91
HBF 112 T6 7,5kW (A3:8) F400 (40°)	Inlet	64	71	76	81	85	87	86	80	92
HBF 125 T6 3kW (A3:4) F400 (24°)	Inlet	66	75	80	87	90	91	93	88	98
HBF 125 T6 3kW (A3:4) F400 (22°)	Inlet	65	77	82	89	92	93	95	91	99
HBF 125 T6 3kW (A3:4) F400 (20°)	Inlet	63	76	81	89	92	92	94	91	99
HBF 125 T6 4kW (A3:4) F400 (26°)	Inlet	66	74	79	85	89	90	91	86	96
HBF 125 T6 4kW (A3:4) F400 (28°)	Inlet	66	73	78	83	87	88	89	84	94
HBF 125 T6 5,5kW (A3:4) F400 (34°)	Inlet	64	71	76	81	84	85	86	79	91
HBF 125 T6 5,5kW (A3:4) F400 (32°)	Inlet	64	71	76	81	84	86	87	80	92
HBF 125 T6 5,5kW (A3:4) F400 (30°)	Inlet	65	72	77	81	85	87	88	81	92
HBF 125 T6 5,5kW (A3:8) F400 (24°)	Inlet	69	76	83	90	96	98	98	92	103
HBF 125 T6 5,5kW (A3:8) F400 (22°)	Inlet	69	77	84	92	97	100	99	94	105
HBF 125 T6 5,5kW (A3:8) F400 (20°)	Inlet	69	77	84	93	98	101	101	95	106
HBF 125 T6 7,5kW (A3:4) F400 (40°)	Inlet	65	72	77	82	84	86	87	80	92
HBF 125 T6 7,5kW (A3:4) F400 (38°)	Inlet	65	72	77	81	84	86	86	79	91
HBF 125 T6 7,5kW (A3:4) F400 (36°)	Inlet	64	71	76	81	83	85	86	79	91
HBF 125 T6 7,5kW (A3:8) F400 (30°)	Inlet	68	74	80	86	91	93	94	87	98
HBF 125 T6 7,5kW (A3:8) F400 (28°)	Inlet	68	74	81	87	93	95	95	89	100
HBF 125 T6 7,5kW (A3:8) F400 (26°)	Inlet	69	75	82	89	94	97	96	90	102
HBF 125 T6 11kW (A3:8) F400 (38°)	Inlet	67	74	79	84	87	89	88	81	94
HBF 125 T6 11kW (A3:8) F400 (36°)	Inlet	67	74	79	84	87	89	89	82	94
HBF 125 T6 11kW (A3:8) F400 (34°)	Inlet	68	74	80	84	88	90	90	83	95
HBF 125 T6 11kW (A3:8) F400 (32°)	Inlet	68	74	80	85	90	92	92	85	97
HBF 125 T6 15kW (A3:8) F400 (40°)	Inlet	67	74	79	83	87	89	87	81	93

Hałas / 4/8 poles
Sound power Lw dB (A)

Model		63 Hz	125 Hz	250 Hz	500 Hz	1000 Hz	2000 Hz	4000 Hz	8000 Hz	Total
HBF 45 T4/T8 0,8/0,2kW (A5:6) F400 (1500 RPM - 40°)	Inlet	50	57	62	67	70	70	71	64	76

Sound power Lw dB (A)

Model		63 Hz	125 Hz	250 Hz	500 Hz	1000 Hz	2000 Hz	4000 Hz	8000 Hz	Total
HBF 45 T4/T8 0,8/0,2kW (A5:6) F400 (750 RPM - 40°)	Inlet	35	42	47	52	55	55	56	49	61
HBF 50 T4/T8 0,8/0,2kW (A5:6) F400 (750 RPM - 40°)	Inlet	38	45	50	54	57	56	57	51	63
HBF 50 T4/T8 0,8/0,2kW (A5:6) F400 (1500 RPM - 40°)	Inlet	53	60	65	69	72	71	72	66	78
HBF 56 T4/T8 0,8/0,2kW (A5:6) F400 (750 RPM - 33°)	Inlet	39	46	51	60	60	61	64	55	68
HBF 56 T4/T8 0,8/0,2kW (A5:6) F400 (750 RPM - 25°)	Inlet	39	47	52	60	64	61	63	55	69
HBF 56 T4/T8 0,8/0,2kW (A5:6) F400 (750 RPM - 30°)	Inlet	41	48	53	62	63	62	65	57	69
HBF 56 T4/T8 0,8/0,2kW (A5:6) F400 (1500 RPM - 25°)	Inlet	54	62	67	75	79	76	78	70	84
HBF 56 T4/T8 0,8/0,2kW (A5:6) F400 (1500 RPM - 33°)	Inlet	54	61	66	75	75	76	79	70	83
HBF 56 T4/T8 0,8/0,2kW (A5:6) F400 (1500 RPM - 30°)	Inlet	56	63	68	77	78	78	80	72	85
HBF 56 T4/T8 1,2/0,3kW (A5:6) F400 (750 RPM - 37°)	Inlet	39	46	51	59	59	60	63	54	67
HBF 56 T4/T8 1,2/0,3kW (A5:6) F400 (750 RPM - 35°)	Inlet	38	45	50	58	58	60	62	54	66
HBF 56 T4/T8 1,2/0,3kW (A5:6) F400 (1500 RPM - 37°)	Inlet	54	61	66	75	74	76	78	69	82
HBF 56 T4/T8 1,2/0,3kW (A5:6) F400 (1500 RPM - 35°)	Inlet	53	60	65	74	73	75	78	69	82
HBF 56 T4/T8 1,6/0,4kW (A5:6) F400 (750 RPM - 40°)	Inlet	41	48	53	60	60	61	63	55	68
HBF 56 T4/T8 1,6/0,4kW (A5:6) F400 (750 RPM - 43°)	Inlet	43	50	55	61	61	62	64	55	69
HBF 56 T4/T8 1,6/0,4kW (A5:6) F400 (1500 RPM - 40°)	Inlet	56	63	68	76	75	76	79	70	83
HBF 56 T4/T8 1,6/0,4kW (A5:6) F400 (1500 RPM - 43°)	Inlet	58	65	70	76	76	77	79	70	84
HBF 63 T4/T8 0,8/0,2kW (A5:6) F400 (750 RPM - 25°)	Inlet	42	51	56	65	65	64	65	60	71
HBF 63 T4/T8 0,8/0,2kW (A5:6) F400 (1500 RPM - 25°)	Inlet	57	66	71	80	80	79	80	75	86
HBF 63 T4/T8 1,2/0,3kW (A5:6) F400 (750 RPM - 30°)	Inlet	45	53	59	65	65	64	67	62	72
HBF 63 T4/T8 1,2/0,3kW (A5:6) F400 (1500 RPM - 30°)	Inlet	60	68	74	80	80	79	82	77	87
HBF 63 T4/T8 1,6/0,4kW (A5:6) F400 (750 RPM - 35°)	Inlet	43	52	57	60	61	60	64	58	68
HBF 63 T4/T8 1,6/0,4kW (A5:6) F400 (1500 RPM - 35°)	Inlet	59	67	72	75	76	76	79	73	83

Sound power Lw dB (A)

Model		63 Hz	125 Hz	250 Hz	500 Hz	1000 Hz	2000 Hz	4000 Hz	8000 Hz	Total
HBF 63 T4/T8 1,6/0,4kW (A5:6) F400 (750 RPM - 33°)	Inlet	44	52	58	62	63	62	65	60	70
HBF 63 T4/T8 1,6/0,4kW (A5:6) F400 (1500 RPM - 33°)	Inlet	59	68	73	77	78	77	80	75	85
HBF 63 T4/T8 2,2/0,37kW (A5:6) F400 (750 RPM - 37°)	Inlet	44	52	57	61	62	62	64	58	69
HBF 63 T4/T8 2,2/0,37kW (A5:6) F400 (750 RPM - 40°)	Inlet	45	52	57	62	62	63	65	58	70
HBF 63 T4/T8 2,2/0,37kW (A5:6) F400 (1500 RPM - 40°)	Inlet	60	67	72	77	78	78	80	73	85
HBF 63 T4/T8 2,2/0,37kW (A5:6) F400 (1500 RPM - 37°)	Inlet	59	67	72	76	77	77	79	73	84
HBF 71 T4/T8 0,8/0,2kW (A5:6) F400 (750 RPM - 20°)	Inlet	40	51	56	71	70	67	69	61	76
HBF 71 T4/T8 0,8/0,2kW (A5:6) F400 (1500 RPM - 20°)	Inlet	55	66	71	86	85	82	84	76	91
HBF 71 T4/T8 1,2/0,3kW (A5:6) F400 (750 RPM - 25°)	Inlet	44	51	56	69	68	67	69	60	75
HBF 71 T4/T8 1,2/0,3kW (A5:6) F400 (1500 RPM - 25°)	Inlet	59	67	72	84	84	82	84	75	90
HBF 71 T4/T8 1,6/0,4kW (A5:6) F400 (750 RPM - 30°)	Inlet	46	53	58	67	67	68	69	58	74
HBF 71 T4/T8 1,6/0,4kW (A5:6) F400 (1500 RPM - 30°)	Inlet	61	68	73	82	82	83	84	73	89
HBF 71 T4/T8 2,2/0,37kW (A5:6) F400 (750 RPM - 35°)	Inlet	47	54	59	61	65	67	68	57	72
HBF 71 T4/T8 2,2/0,37kW (A5:6) F400 (750 RPM - 33°)	Inlet	46	53	58	64	66	68	68	58	73
HBF 71 T4/T8 2,2/0,37kW (A5:6) F400 (1500 RPM - 35°)	Inlet	62	69	74	76	80	82	83	72	87
HBF 71 T4/T8 2,2/0,37kW (A5:6) F400 (1500 RPM - 33°)	Inlet	62	69	74	79	81	83	84	73	88
HBF 71 T4/T8 3/0,55kW (A5:6) F400 (750 RPM - 40°)	Inlet	52	58	64	66	69	70	71	61	76
HBF 71 T4/T8 3/0,55kW (A5:6) F400 (750 RPM - 37°)	Inlet	50	56	62	64	67	69	70	59	74
HBF 71 T4/T8 3/0,55kW (A5:6) F400 (1500 RPM - 40°)	Inlet	67	73	79	81	84	85	86	76	91
HBF 71 T4/T8 3/0,55kW (A5:6) F400 (1500 RPM - 37°)	Inlet	65	71	77	79	82	84	85	74	89
HBF 80 T4/T8 3/0,55kW (A5:6) F400 (750 RPM - 35°)	Inlet	47	54	59	64	67	67	71	61	74
HBF 80 T4/T8 3/0,55kW (A5:6) F400 (1500 RPM - 35°)	Inlet	62	69	74	79	82	82	86	76	89
HBF 80 T4/T8 3/0,55kW (A5:6) F400 (750 RPM - 33°)	Inlet	48	55	60	66	69	69	73	64	76

Sound power Lw dB (A)

Model		63 Hz	125 Hz	250 Hz	500 Hz	1000 Hz	2000 Hz	4000 Hz	8000 Hz	Total
HBF 80 T4/T8 3/0,55kW (A5:6) F400 (1500 RPM - 33°)	Inlet	63	70	75	81	85	84	88	80	91
HBF 80 T4/T8 3/0,55kW (A5:6) F400 (1500 RPM - 30°)	Inlet	64	71	76	83	87	86	90	83	94
HBF 80 T4/T8 3/0,55kW (A5:6) F400 (750 RPM - 30°)	Inlet	49	56	61	68	72	71	74	68	79
HBF 80 T4/T8 4/0,75kW (A5:6) F400 (750 RPM - 37°)	Inlet	49	56	61	65	68	68	71	61	75
HBF 80 T4/T8 4/0,75kW (A5:6) F400 (1500 RPM - 37°)	Inlet	64	71	76	80	83	83	86	76	90
HBF 80 T4/T8 4/0,75kW (A5:6) F400 (750 RPM - 40°)	Inlet	51	58	63	67	69	69	70	61	76
HBF 80 T4/T8 4/0,75kW (A5:6) F400 (1500 RPM - 40°)	Inlet	66	73	78	82	84	84	86	76	91
HBF 90 T4/T8 2,8/0,7kW (A3:4) F400 (1420 RPM - 22°)	Inlet	61	69	74	83	87	87	86	77	92
HBF 90 T4/T8 2,8/0,7kW (A3:4) F400 (1420 RPM - 20°)	Inlet	57	68	73	84	88	88	86	78	93
HBF 90 T4/T8 2,8/0,7kW (A3:4) F400 (720 RPM - 22°)	Inlet	45	53	58	67	71	71	70	62	76
HBF 90 T4/T8 2,8/0,7kW (A3:4) F400 (720 RPM - 20°)	Inlet	41	52	57	68	72	72	70	62	77
HBF 90 T4/T8 4/0,75kW (A3:4) F400 (1420 RPM - 26°)	Inlet	64	71	76	83	85	85	84	76	91
HBF 90 T4/T8 4/0,75kW (A3:4) F400 (1420 RPM - 24°)	Inlet	63	70	75	83	86	86	85	77	91
HBF 90 T4/T8 4/0,75kW (A3:4) F400 (720 RPM - 26°)	Inlet	48	55	60	67	69	69	68	60	75
HBF 90 T4/T8 4/0,75kW (A3:4) F400 (720 RPM - 24°)	Inlet	47	54	59	67	70	70	69	61	75
HBF 90 T4/T8 5,5/1,1kW (A3:4) F400 (1420 RPM - 30°)	Inlet	66	73	78	83	83	83	83	75	89
HBF 90 T4/T8 5,5/1,1kW (A3:4) F400 (1420 RPM - 28°)	Inlet	65	72	77	83	84	84	84	76	90
HBF 90 T4/T8 5,5/1,1kW (A3:4) F400 (1420 RPM - 32°)	Inlet	66	73	78	82	83	83	83	75	89
HBF 90 T4/T8 5,5/1,1kW (A3:4) F400 (720 RPM - 32°)	Inlet	50	57	62	66	67	67	67	59	73
HBF 90 T4/T8 5,5/1,1kW (A3:4) F400 (720 RPM - 30°)	Inlet	51	58	63	67	67	67	67	59	74
HBF 90 T4/T8 5,5/1,1kW (A3:4) F400 (720 RPM - 28°)	Inlet	49	56	61	67	68	68	68	60	74
HBF 90 T4/T8 5,5/1,1kW (A3:8) F400 (1420 RPM - 22°)	Inlet	69	80	88	90	92	87	88	78	97
HBF 90 T4/T8 5,5/1,1kW (A3:8) F400 (1420 RPM - 20°)	Inlet	69	81	90	91	93	87	88	78	98

Sound power Lw dB (A)

Model		63 Hz	125 Hz	250 Hz	500 Hz	1000 Hz	2000 Hz	4000 Hz	8000 Hz	Total
HBF 90 T4/T8 5,5/1,1kW (A3:8) F400 (720 RPM - 22°)	Inlet	53	64	72	74	76	72	72	62	81
HBF 90 T4/T8 5,5/1,1kW (A3:8) F400 (720 RPM - 20°)	Inlet	53	65	74	75	77	71	72	62	82
HBF 90 T4/T8 7,5/1,5kW (A3:4) F400 (1420 RPM - 34°)	Inlet	65	72	77	81	83	84	82	74	89
HBF 90 T4/T8 7,5/1,5kW (A3:4) F400 (1420 RPM - 38°)	Inlet	67	74	79	82	85	84	83	76	91
HBF 90 T4/T8 7,5/1,5kW (A3:4) F400 (1420 RPM - 36°)	Inlet	66	73	78	81	84	84	82	74	90
HBF 90 T4/T8 7,5/1,5kW (A3:4) F400 (1420 RPM - 32°)	Inlet	66	73	78	82	83	83	83	75	89
HBF 90 T4/T8 7,5/1,5kW (A3:4) F400 (720 RPM - 38°)	Inlet	51	58	63	66	69	69	67	60	75
HBF 90 T4/T8 7,5/1,5kW (A3:4) F400 (720 RPM - 36°)	Inlet	50	57	62	66	68	68	67	58	74
HBF 90 T4/T8 7,5/1,5kW (A3:4) F400 (720 RPM - 34°)	Inlet	50	57	62	66	67	68	66	58	73
HBF 90 T4/T8 7,5/1,5kW (A3:4) F400 (720 RPM - 32°)	Inlet	50	57	62	66	67	67	67	59	73
HBF 90 T4/T8 7,5/1,5kW (A3:8) F400 (1420 RPM - 28°)	Inlet	70	76	82	87	89	88	87	79	94
HBF 90 T4/T8 7,5/1,5kW (A3:8) F400 (1420 RPM - 26°)	Inlet	70	78	84	88	90	88	88	79	95
HBF 90 T4/T8 7,5/1,5kW (A3:8) F400 (1420 RPM - 24°)	Inlet	69	79	86	89	91	88	88	78	96
HBF 90 T4/T8 7,5/1,5kW (A3:8) F400 (720 RPM - 28°)	Inlet	54	60	66	71	73	72	71	63	79
HBF 90 T4/T8 7,5/1,5kW (A3:8) F400 (720 RPM - 26°)	Inlet	54	62	68	72	74	72	72	63	79
HBF 90 T4/T8 7,5/1,5kW (A3:8) F400 (720 RPM - 24°)	Inlet	54	63	70	73	75	72	72	63	80
HBF 90 T4/T8 11/3kW (A3:4) F400 (1420 RPM - 40°)	Inlet	68	75	80	83	87	85	84	77	91
HBF 90 T4/T8 11/3kW (A3:4) F400 (720 RPM - 40°)	Inlet	52	59	64	67	71	69	68	61	75
HBF 90 T4/T8 11/3kW (A3:8) F400 (1420 RPM - 36°)	Inlet	67	74	79	83	87	87	85	77	92
HBF 90 T4/T8 11/3kW (A3:8) F400 (1420 RPM - 34°)	Inlet	67	74	79	84	87	87	85	77	92
HBF 90 T4/T8 11/3kW (A3:8) F400 (1420 RPM - 32°)	Inlet	67	74	79	85	87	87	86	78	93
HBF 90 T4/T8 11/3kW (A3:8) F400 (1420 RPM - 30°)	Inlet	68	75	80	86	88	88	87	79	94
HBF 90 T4/T8 11/3kW (A3:8) F400 (720 RPM - 36°)	Inlet	51	58	63	67	71	71	69	61	76

Sound power Lw dB (A)

Model		63 Hz	125 Hz	250 Hz	500 Hz	1000 Hz	2000 Hz	4000 Hz	8000 Hz	Total
HBF 90 T4/T8 11/3kW (A3:8) F400 (720 RPM - 34°)	Inlet	51	58	63	68	71	71	69	61	76
HBF 90 T4/T8 11/3kW (A3:8) F400 (720 RPM - 32°)	Inlet	52	59	64	69	71	72	70	62	77
HBF 90 T4/T8 11/3kW (A3:8) F400 (720 RPM - 30°)	Inlet	52	59	64	70	72	72	71	63	78
HBF 90 T4/T8 14/3,5kW (A3:8) F400 (1420 RPM - 40°)	Inlet	71	78	83	84	88	87	84	78	93
HBF 90 T4/T8 14/3,5kW (A3:8) F400 (1420 RPM - 38°)	Inlet	69	76	81	84	87	87	84	77	92
HBF 90 T4/T8 14/3,5kW (A3:8) F400 (720 RPM - 40°)	Inlet	55	62	67	68	72	71	68	62	77
HBF 90 T4/T8 14/3,5kW (A3:8) F400 (720 RPM - 38°)	Inlet	53	60	65	68	71	71	69	61	77
HBF 100 T4/T8 5,5/1,1kW (A3:4) F400 (1420 RPM - 26°)	Inlet	67	75	81	87	90	91	93	88	97
HBF 100 T4/T8 5,5/1,1kW (A3:4) F400 (1420 RPM - 24°)	Inlet	67	76	81	87	91	92	93	89	98
HBF 100 T4/T8 5,5/1,1kW (A3:4) F400 (1420 RPM - 22°)	Inlet	66	76	82	88	91	92	93	90	98
HBF 100 T4/T8 5,5/1,1kW (A3:4) F400 (1420 RPM - 20°)	Inlet	66	76	81	88	91	92	93	90	98
HBF 100 T4/T8 5,5/1,1kW (A3:4) F400 (720 RPM - 26°)	Inlet	51	59	65	71	74	75	77	72	82
HBF 100 T4/T8 5,5/1,1kW (A3:4) F400 (720 RPM - 24°)	Inlet	51	60	66	72	75	76	77	73	82
HBF 100 T4/T8 5,5/1,1kW (A3:4) F400 (720 RPM - 22°)	Inlet	50	60	66	72	76	76	77	74	82
HBF 100 T4/T8 5,5/1,1kW (A3:4) F400 (720 RPM - 20°)	Inlet	50	60	66	72	76	76	77	74	82
HBF 100 T4/T8 7,5/1,5kW (A3:4) F400 (1420 RPM - 30°)	Inlet	68	74	81	86	90	91	93	86	97
HBF 100 T4/T8 7,5/1,5kW (A3:4) F400 (1420 RPM - 28°)	Inlet	67	75	81	86	90	91	93	87	97
HBF 100 T4/T8 7,5/1,5kW (A3:4) F400 (720 RPM - 30°)	Inlet	52	59	65	70	74	75	77	70	81
HBF 100 T4/T8 7,5/1,5kW (A3:4) F400 (720 RPM - 28°)	Inlet	51	59	65	71	74	75	77	71	81
HBF 100 T4/T8 7,5/1,5kW (A3:8) F400 (1420 RPM - 20°)	Inlet	72	81	92	102	100	99	100	95	107
HBF 100 T4/T8 7,5/1,5kW (A3:8) F400 (720 RPM - 20°)	Inlet	56	65	76	86	84	83	84	79	91
HBF 100 T4/T8 11/3kW (A3:4) F400 (1420 RPM - 38°)	Inlet	68	74	81	86	89	90	92	85	96
HBF 100 T4/T8 11/3kW (A3:4) F400 (1420 RPM - 36°)	Inlet	69	73	81	86	88	90	91	85	96

Sound power Lw dB (A)

Model		63 Hz	125 Hz	250 Hz	500 Hz	1000 Hz	2000 Hz	4000 Hz	8000 Hz	Total
HBF 100 T4/T8 11/3kW (A3:4) F400 (1420 RPM - 34°)	Inlet	69	73	81	85	88	90	91	85	96
HBF 100 T4/T8 11/3kW (A3:4) F400 (1420 RPM - 32°)	Inlet	68	74	81	86	89	90	92	86	96
HBF 100 T4/T8 11/3kW (A3:4) F400 (720 RPM - 38°)	Inlet	52	58	65	70	73	74	76	69	80
HBF 100 T4/T8 11/3kW (A3:4) F400 (720 RPM - 36°)	Inlet	53	57	65	70	72	74	75	69	80
HBF 100 T4/T8 11/3kW (A3:4) F400 (720 RPM - 34°)	Inlet	53	57	65	69	72	74	76	69	80
HBF 100 T4/T8 11/3kW (A3:4) F400 (720 RPM - 32°)	Inlet	52	58	65	70	73	74	76	70	80
HBF 100 T4/T8 11/3kW (A3:8) F400 (1420 RPM - 28°)	Inlet	72	79	87	93	96	95	96	91	102
HBF 100 T4/T8 11/3kW (A3:8) F400 (1420 RPM - 24°)	Inlet	72	79	89	97	97	97	98	93	104
HBF 100 T4/T8 11/3kW (A3:8) F400 (1420 RPM - 22°)	Inlet	72	80	91	100	99	98	99	94	106
HBF 100 T4/T8 11/3kW (A3:8) F400 (1420 RPM - 26°)	Inlet	72	79	88	95	96	96	97	92	103
HBF 100 T4/T8 11/3kW (A3:8) F400 (720 RPM - 28°)	Inlet	56	63	71	77	80	80	80	75	86
HBF 100 T4/T8 11/3kW (A3:8) F400 (720 RPM - 26°)	Inlet	56	63	72	79	80	80	81	76	87
HBF 100 T4/T8 11/3kW (A3:8) F400 (720 RPM - 24°)	Inlet	56	64	73	81	82	81	82	77	88
HBF 100 T4/T8 11/3kW (A3:8) F400 (720 RPM - 22°)	Inlet	56	64	75	84	83	82	83	78	90
HBF 100 T4/T8 14/3,5kW (A3:4) F400 (1420 RPM - 40°)	Inlet	68	75	81	87	90	91	92	86	97
HBF 100 T4/T8 14/3,5kW (A3:4) F400 (720 RPM - 40°)	Inlet	52	59	66	71	75	75	76	70	81
HBF 100 T4/T8 14/3,5kW (A3:8) F400 (1420 RPM - 32°)	Inlet	71	79	84	90	93	94	95	89	100
HBF 100 T4/T8 14/3,5kW (A3:8) F400 (1420 RPM - 30°)	Inlet	72	79	86	91	95	95	96	90	101
HBF 100 T4/T8 14/3,5kW (A3:8) F400 (720 RPM - 32°)	Inlet	55	63	68	74	77	78	79	73	84
HBF 100 T4/T8 14/3,5kW (A3:8) F400 (720 RPM - 30°)	Inlet	56	63	70	75	79	79	80	74	85
HBF 100 T4/T8 17/4,3kW (A3:8) F400 (1420 RPM - 36°)	Inlet	70	77	82	87	91	93	94	87	99
HBF 100 T4/T8 17/4,3kW (A3:8) F400 (1420 RPM - 34°)	Inlet	71	78	83	88	92	93	94	88	99
HBF 100 T4/T8 17/4,3kW (A3:8) F400 (720 RPM - 36°)	Inlet	54	61	66	71	75	77	78	72	83

Sound power Lw dB (A)

Model		63 Hz	125 Hz	250 Hz	500 Hz	1000 Hz	2000 Hz	4000 Hz	8000 Hz	Total
HBF 100 T4/T8 17/4,3kW (A3:8) F400 (720 RPM - 34°)	Inlet	55	62	67	72	76	77	78	72	83
HBF 100 T4/T8 20/5kW (A3:8) F400 (1420 RPM - 38°)	Inlet	71	78	83	88	92	94	94	88	99
HBF 100 T4/T8 20/5kW (A3:8) F400 (1420 RPM - 40°)	Inlet	71	79	84	89	92	94	95	89	100
HBF 100 T4/T8 20/5kW (A3:8) F400 (720 RPM - 40°)	Inlet	56	63	68	73	76	78	79	73	84
HBF 100 T4/T8 20/5kW (A3:8) F400 (720 RPM - 38°)	Inlet	55	62	67	72	76	78	78	72	83
HBF 112 T4/T8 5,5/1,1kW (A3:4) F400 (1420 RPM - 20°)	Inlet	66	78	83	90	94	94	96	92	101
HBF 112 T4/T8 5,5/1,1kW (A3:4) F400 (720 RPM - 20°)	Inlet	50	62	67	74	78	78	80	76	85
HBF 112 T4/T8 7,5/1,5kW (A3:4) F400 (1420 RPM - 22°)	Inlet	68	79	84	90	94	95	96	92	102
HBF 112 T4/T8 7,5/1,5kW (A3:4) F400 (1420 RPM - 24°)	Inlet	69	78	83	90	93	94	96	91	101
HBF 112 T4/T8 7,5/1,5kW (A3:4) F400 (720 RPM - 24°)	Inlet	53	62	67	74	77	78	80	75	85
HBF 112 T4/T8 7,5/1,5kW (A3:4) F400 (720 RPM - 22°)	Inlet	52	63	68	74	78	79	81	76	86
HBF 112 T4/T8 11/3kW (A3:4) F400 (1420 RPM - 32°)	Inlet	70	77	82	87	91	92	94	87	98
HBF 112 T4/T8 11/3kW (A3:4) F400 (1420 RPM - 30°)	Inlet	71	78	83	88	92	93	94	88	99
HBF 112 T4/T8 11/3kW (A3:4) F400 (1420 RPM - 28°)	Inlet	71	78	83	89	92	93	95	89	99
HBF 112 T4/T8 11/3kW (A3:4) F400 (1420 RPM - 26°)	Inlet	70	78	83	89	93	94	95	90	100
HBF 112 T4/T8 11/3kW (A3:4) F400 (720 RPM - 32°)	Inlet	55	61	67	72	75	76	78	71	82
HBF 112 T4/T8 11/3kW (A3:4) F400 (720 RPM - 30°)	Inlet	55	62	67	72	76	77	78	72	83
HBF 112 T4/T8 11/3kW (A3:4) F400 (720 RPM - 28°)	Inlet	55	62	67	73	76	77	79	73	83
HBF 112 T4/T8 11/3kW (A3:4) F400 (720 RPM - 26°)	Inlet	54	62	67	73	77	78	79	74	84
HBF 112 T4/T8 11/3kW (A3:8) F400 (1420 RPM - 20°)	Inlet	73	82	92	101	101	103	103	97	109
HBF 112 T4/T8 11/3kW (A3:8) F400 (720 RPM - 20°)	Inlet	57	66	76	85	85	87	87	81	93
HBF 112 T4/T8 14/3,5kW (A3:4) F400 (1420 RPM - 34°)	Inlet	70	76	82	87	90	92	93	86	98
HBF 112 T4/T8 14/3,5kW (A3:4) F400 (1420 RPM - 36°)	Inlet	71	76	83	87	90	92	93	86	98

Sound power Lw dB (A)

Model		63 Hz	125 Hz	250 Hz	500 Hz	1000 Hz	2000 Hz	4000 Hz	8000 Hz	Total
HBF 112 T4/T8 14/3,5kW (A3:4) F400 (720 RPM - 36°)	Inlet	55	60	67	71	74	76	77	70	82
HBF 112 T4/T8 14/3,5kW (A3:4) F400 (720 RPM - 34°)	Inlet	54	60	66	71	74	76	77	70	82
HBF 112 T4/T8 14/3,5kW (A3:8) F400 (1420 RPM - 26°)	Inlet	74	81	89	96	98	100	100	94	106
HBF 112 T4/T8 14/3,5kW (A3:8) F400 (1420 RPM - 24°)	Inlet	73	81	90	97	99	101	101	95	106
HBF 112 T4/T8 14/3,5kW (A3:8) F400 (1420 RPM - 22°)	Inlet	73	81	91	99	100	102	102	96	107
HBF 112 T4/T8 14/3,5kW (A3:8) F400 (720 RPM - 26°)	Inlet	58	65	73	80	83	84	84	78	90
HBF 112 T4/T8 14/3,5kW (A3:8) F400 (720 RPM - 24°)	Inlet	57	65	74	81	83	85	85	79	90
HBF 112 T4/T8 14/3,5kW (A3:8) F400 (720 RPM - 22°)	Inlet	57	65	75	83	84	86	86	80	91
HBF 112 T4/T8 17/4,3kW (A3:4) F400 (1420 RPM - 40°)	Inlet	72	79	84	89	91	93	94	87	99
HBF 112 T4/T8 17/4,3kW (A3:4) F400 (1420 RPM - 38°)	Inlet	71	77	83	88	91	92	93	87	98
HBF 112 T4/T8 17/4,3kW (A3:4) F400 (720 RPM - 40°)	Inlet	56	63	68	73	76	77	78	71	83
HBF 112 T4/T8 17/4,3kW (A3:4) F400 (720 RPM - 38°)	Inlet	55	61	67	72	75	76	78	71	82
HBF 112 T4/T8 17/4,3kW (A3:8) F400 (1420 RPM - 30°)	Inlet	74	80	87	93	97	99	99	93	104
HBF 112 T4/T8 17/4,3kW (A3:8) F400 (1420 RPM - 28°)	Inlet	74	81	88	94	98	99	99	94	105
HBF 112 T4/T8 17/4,3kW (A3:8) F400 (720 RPM - 30°)	Inlet	58	65	72	77	81	83	83	77	88
HBF 112 T4/T8 17/4,3kW (A3:8) F400 (720 RPM - 28°)	Inlet	58	65	72	78	82	83	83	78	89
HBF 112 T4/T8 20/5kW (A3:8) F400 (1420 RPM - 32°)	Inlet	74	81	86	91	96	97	97	91	103
HBF 112 T4/T8 20/5kW (A3:8) F400 (720 RPM - 32°)	Inlet	58	65	70	76	80	81	81	75	87
HBF 112 T4/T8 28/6,5kW (A3:8) F400 (1420 RPM - 34°)	Inlet	73	80	85	90	94	96	96	89	101
HBF 112 T4/T8 28/6,5kW (A3:8) F400 (1420 RPM - 40°)	Inlet	74	81	86	90	94	96	95	90	101
HBF 112 T4/T8 28/6,5kW (A3:8) F400 (1420 RPM - 38°)	Inlet	73	80	85	90	94	96	95	89	101
HBF 112 T4/T8 28/6,5kW (A3:8) F400 (1420 RPM - 36°)	Inlet	73	80	85	90	93	95	95	89	101
HBF 112 T4/T8 28/6,5kW (A3:8) F400 (720 RPM - 40°)	Inlet	58	65	70	74	78	80	80	74	85

Sound power Lw dB (A)

Model		63 Hz	125 Hz	250 Hz	500 Hz	1000 Hz	2000 Hz	4000 Hz	8000 Hz	Total
HBF 112 T4/T8 28/6,5kW (A3:8) F400 (720 RPM - 38°)	Inlet	57	64	69	74	78	80	80	73	85
HBF 112 T4/T8 28/6,5kW (A3:8) F400 (720 RPM - 36°)	Inlet	57	64	69	74	77	79	80	73	85
HBF 112 T4/T8 28/6,5kW (A3:8) F400 (720 RPM - 34°)	Inlet	57	64	69	74	78	80	80	73	85
HBF 125 T4/T8 11/3kW (A3:4) F400 (1420 RPM - 22°)	Inlet	75	86	91	98	102	103	105	101	109
HBF 125 T4/T8 11/3kW (A3:4) F400 (1420 RPM - 20°)	Inlet	72	85	90	98	102	102	104	101	109
HBF 125 T4/T8 11/3kW (A3:4) F400 (720 RPM - 22°)	Inlet	59	70	75	82	86	87	89	85	93
HBF 125 T4/T8 11/3kW (A3:4) F400 (720 RPM - 20°)	Inlet	56	69	74	82	86	86	88	85	93
HBF 125 T4/T8 14/3,5kW (A3:4) F400 (1420 RPM - 26°)	Inlet	76	84	89	94	98	99	101	95	106
HBF 125 T4/T8 14/3,5kW (A3:4) F400 (1420 RPM - 24°)	Inlet	75	85	90	96	100	101	103	98	107
HBF 125 T4/T8 14/3,5kW (A3:4) F400 (720 RPM - 26°)	Inlet	60	68	73	78	82	83	85	80	90
HBF 125 T4/T8 14/3,5kW (A3:4) F400 (720 RPM - 24°)	Inlet	59	69	74	80	84	85	87	82	91
HBF 125 T4/T8 17/4,3kW (A3:4) F400 (1420 RPM - 28°)	Inlet	75	82	87	93	96	98	99	93	104
HBF 125 T4/T8 17/4,3kW (A3:4) F400 (1420 RPM - 30°)	Inlet	74	81	86	91	95	96	97	91	102
HBF 125 T4/T8 17/4,3kW (A3:4) F400 (720 RPM - 30°)	Inlet	58	65	70	75	79	80	81	75	86
HBF 125 T4/T8 17/4,3kW (A3:4) F400 (720 RPM - 28°)	Inlet	60	67	72	77	80	82	83	77	88
HBF 125 T4/T8 20/5kW (A3:4) F400 (1420 RPM - 34°)	Inlet	73	80	85	90	93	95	96	88	101
HBF 125 T4/T8 20/5kW (A3:4) F400 (1420 RPM - 32°)	Inlet	74	81	86	90	94	96	96	90	102
HBF 125 T4/T8 20/5kW (A3:4) F400 (720 RPM - 34°)	Inlet	58	65	70	74	77	79	80	72	85
HBF 125 T4/T8 20/5kW (A3:4) F400 (720 RPM - 32°)	Inlet	58	65	70	75	78	80	81	74	86
HBF 125 T4/T8 20/5kW (A3:8) F400 (1420 RPM - 24°)	Inlet	78	85	92	100	106	108	108	102	113
HBF 125 T4/T8 20/5kW (A3:8) F400 (1420 RPM - 22°)	Inlet	79	86	93	102	107	110	109	104	114
HBF 125 T4/T8 20/5kW (A3:8) F400 (1420 RPM - 20°)	Inlet	78	86	93	103	108	111	110	105	115
HBF 125 T4/T8 20/5kW (A3:8) F400 (720 RPM - 24°)	Inlet	62	70	76	84	90	92	92	86	97

Sound power Lw dB (A)

Model		63 Hz	125 Hz	250 Hz	500 Hz	1000 Hz	2000 Hz	4000 Hz	8000 Hz	Total
HBF 125 T4/T8 20/5kW (A3:8) F400 (720 RPM - 22°)	Inlet	63	70	77	86	91	94	93	88	98
HBF 125 T4/T8 20/5kW (A3:8) F400 (720 RPM - 20°)	Inlet	62	71	78	87	92	95	94	89	99
HBF 125 T4/T8 28/6,5kW (A3:4) F400 (1420 RPM - 40°)	Inlet	75	82	87	91	93	96	96	89	102
HBF 125 T4/T8 28/6,5kW (A3:4) F400 (1420 RPM - 38°)	Inlet	74	81	86	91	93	95	96	89	101
HBF 125 T4/T8 28/6,5kW (A3:4) F400 (1420 RPM - 36°)	Inlet	74	81	86	90	93	95	96	88	101
HBF 125 T4/T8 28/6,5kW (A3:4) F400 (720 RPM - 40°)	Inlet	59	66	71	75	78	80	80	73	86
HBF 125 T4/T8 28/6,5kW (A3:4) F400 (720 RPM - 38°)	Inlet	58	65	70	75	77	79	80	73	85
HBF 125 T4/T8 28/6,5kW (A3:4) F400 (720 RPM - 36°)	Inlet	58	65	70	74	77	79	80	72	85
HBF 125 T4/T8 28/6,5kW (A3:8) F400 (1420 RPM - 30°)	Inlet	77	83	90	96	101	103	104	97	108
HBF 125 T4/T8 28/6,5kW (A3:8) F400 (1420 RPM - 28°)	Inlet	78	84	91	97	102	105	105	98	110
HBF 125 T4/T8 28/6,5kW (A3:8) F400 (1420 RPM - 26°)	Inlet	78	85	91	98	104	106	106	100	111
HBF 125 T4/T8 28/6,5kW (A3:8) F400 (720 RPM - 30°)	Inlet	62	67	74	80	85	87	88	81	92
HBF 125 T4/T8 28/6,5kW (A3:8) F400 (720 RPM - 28°)	Inlet	62	68	75	81	86	89	89	82	94
HBF 125 T4/T8 28/6,5kW (A3:8) F400 (720 RPM - 26°)	Inlet	62	69	75	82	88	90	90	84	95
HBF 125 T4/T8 37/9,2kW (A3:8) F400 (1420 RPM - 36°)	Inlet	77	83	89	93	96	98	98	91	104
HBF 125 T4/T8 37/9,2kW (A3:8) F400 (1420 RPM - 34°)	Inlet	77	83	89	94	97	99	100	92	105
HBF 125 T4/T8 37/9,2kW (A3:8) F400 (1420 RPM - 32°)	Inlet	77	83	89	95	99	102	102	94	107
HBF 125 T4/T8 37/9,2kW (A3:8) F400 (720 RPM - 36°)	Inlet	61	68	73	77	81	83	82	75	88
HBF 125 T4/T8 37/9,2kW (A3:8) F400 (720 RPM - 34°)	Inlet	61	68	73	78	81	84	84	76	89
HBF 125 T4/T8 37/9,2kW (A3:8) F400 (720 RPM - 32°)	Inlet	61	67	73	79	83	86	86	79	91
HBF 125 T4/T8 44/11kW (A3:8) F400 (1420 RPM - 40°)	Inlet	76	83	88	93	96	98	97	90	103
HBF 125 T4/T8 44/11kW (A3:8) F400 (1420 RPM - 38°)	Inlet	76	83	88	93	96	98	97	91	104
HBF 125 T4/T8 44/11kW (A3:8) F400 (720 RPM - 40°)	Inlet	60	67	72	77	80	82	81	74	87

Sound power Lw dB (A)

Model		63 Hz	125 Hz	250 Hz	500 Hz	1000 Hz	2000 Hz	4000 Hz	8000 Hz	Total
HBF 125 T4/T8 44/11kW (A3:8) F400 (720 RPM - 38°)	Inlet	60	67	72	77	80	82	82	75	88

erp data

ERP	
Fan type	Axial fan
Instalation category	A
Efficiency category	Static
The fan has to be installed with FSC	No

ERP / 4 poles

Model	Motor power (kW)	Maximum efficiency point data						
		Max. efficiency (%)	Efficiency grade (N) (N)	Air Flow (m3/h)	Ps (Pa)	Pabs (kW)	speed (rpm)	Specific ratio
HBF 45 T4 0,75kW (A5:6) F400 (°)	0,75	25,22	34,25	3.938,40	91,48	0,37	1404	1,00
HBF 50 T4 0,75kW (A5:6) F400 (°)	0,75	33,75	41,93	5.631,13	108,38	0,51	1404	1,00
HBF 56 T4 0,75kW (A5:6) F400 (°)	0,75	38,49	46,08	5.286,46	156,65	0,63	1404	1,00
HBF 56 T4 0,75kW (A5:6) F400 (°)	0,75	38,91	45,71	6.799,71	163,76	0,84	1404	1,00
HBF 56 T4 0,75kW (A5:6) F400 (°)	0,75	40,36	47,48	6.377,29	162,70	0,75	1404	1,00
HBF 56 T4 1,1kW (A5:6) F400 (°)	1,1	35,94	41,99	7.864,11	175,27	1,11	1392	1,00
HBF 56 T4 1,1kW (A5:6) F400 (°)	1,1	37,33	43,85	7.198,19	163,79	0,93	1392	1,00
HBF 56 T4 1,5kW (A5:6) F400 (°)	1,5	35,35	41	8.575,19	185,04	1,28	1410	1,00
HBF 56 T4 1,5kW (A5:6) F400 (°)	1,5	35,43	40,72	9.299,95	193,09	1,46	1410	1,00
HBF 63 T4 0,75kW (A5:6) F400 (°)	0,75	46,63	53,25	7.384,78	192,08	0,90	1404	1,00
HBF 63 T4 1,1kW (A5:6) F400 (°)	1,1	46,52	52,17	9.056,31	221,36	1,28	1392	1,00
HBF 63 T4 1,5kW (A5:6) F400 (°)	1,5	42,12	47,20	10.066,20	229,21	1,58	1410	1,00
HBF 63 T4 1,5kW (A5:6) F400 (°)	1,5	44,39	49,74	9.588,71	224,77	1,43	1410	1,00
HBF 63 T4 2,2kW (A5:6) F400 (°)	2,2	38,35	42,73	11.588,88	230,37	2,03	1420	1,00
HBF 63 T4 2,2kW (A5:6) F400 (°)	2,2	40,03	44,74	10.830,65	229,31	1,81	1420	1,00
HBF 71 T4 0,75kW (A5:6) F400 (°)	0,75	47,01	53,39	7.908,74	201,69	0,98	1404	1,00
HBF 71 T4 1,1kW (A5:6) F400 (°)	1,1	45,67	51,11	9.865,86	221,15	1,39	1392	1,00
HBF 71 T4 1,5kW (A5:6) F400 (°)	1,5	46,22	50,95	11.855,32	240,58	1,80	1410	1,00
HBF 71 T4 2,2kW (A5:6) F400 (°)	2,2	42,32	46,19	14.007,05	256,86	2,46	1420	1,00
HBF 71 T4 2,2kW (A5:6) F400 (°)	2,2	43,85	48,11	12.922	248,26	2,13	1420	1,00
HBF 71 T4 3kW (A5:6) F400 (°)	3	39,37	42,79	15.295,05	255,96	2,89	1420	1,00
HBF 71 T4 3kW (A5:6) F400 (°)	3	40,72	44,36	14.637,66	255,51	2,67	1420	1,00
HBF 80 T4 3kW (A5:6) F400 (°)	3	47,47	50,44	18.603,39	298,09	3,41	1420	1,00
HBF 80 T4 3kW (A5:6) F400 (°)	3	49,89	53,19	17.421,07	297,07	3,02	1420	1,00
HBF 80 T4 3kW (A5:6) F400 (°)	3	53,27	56,95	16.269,95	295,38	2,63	1420	1,00
HBF 80 T4 4kW (A5:6) F400 (°)	4	46,01	48,67	20.008,80	305,30	3,81	1428	1,00
HBF 80 T4 4kW (A5:6) F400 (°)	4	45,44	47,83	21.569,23	310,17	4,22	1428	1,00
HBF 90 T4 3kW (A3:4) F400 (°)	3	48,40	51,64	16.269,79	312,06	3,09	1420	1,00



Model	Motor power (kW)	Maximum efficiency point data						
		Max. efficiency (%)	Efficiency grade (N) (N)	Air Flow (m3/h)	Ps (Pa)	Pabs (kW)	speed (rpm)	Specific ratio
HBF 90 T4 3kW (A3:4) F400 (°)	3	49,88	53,58	14.806,82	298,15	2,61	1420	1,00
HBF 90 T4 4kW (A3:4) F400 (°)	4	46,06	48,49	19.259,13	340,14	4,15	1428	1,00
HBF 90 T4 4kW (A3:4) F400 (°)	4	47,50	50,34	17.768,06	326,89	3,58	1428	1,00
HBF 90 T4 5,5kW (A3:4) F400 (°)	5,5	43,92	45,63	22.345,93	367,81	5,41	1450	1,00
HBF 90 T4 5,5kW (A3:4) F400 (°)	5,5	45,22	47,29	20.822,29	353,92	4,73	1450	1,00
HBF 90 T4 5,5kW (A3:4) F400 (°)	5,5	42,44	43,93	23.455,15	367,14	5,86	1450	1,00
HBF 90 T4 5,5kW (A3:8) F400 (°)	5,5	47,68	49,45	17.497,66	461,40	5,27	1450	1,00
HBF 90 T4 5,5kW (A3:8) F400 (°)	5,5	48,67	50,84	15.786,74	450,04	4,57	1450	1,00
HBF 90 T4 5,5kW (A3:8) F400 (°)	5,5	46,56	47,96	19.242,52	472,46	6,05	1450	1,00
HBF 90 T4 7,5kW (A3:4) F400 (°)	7,5	41,38	42,67	24.607,17	366,35	6,30	1453	1,00
HBF 90 T4 7,5kW (A3:4) F400 (°)	7,5	37,31	38,09	27.009,72	360,41	7,58	1453	1,00
HBF 90 T4 7,5kW (A3:4) F400 (°)	7,5	39,50	40,55	25.787,41	364,05	6,88	1453	1,00
HBF 90 T4 7,5kW (A3:8) F400 (°)	7,5	45,05	45,76	22.907,92	496,52	7,76	1453	1,00
HBF 90 T4 7,5kW (A3:8) F400 (°)	7,5	46,06	47,13	21.070,55	483,55	6,84	1453	1,00
HBF 90 T4 11kW (A3:4) F400 (°)	11	35,47	36,01	28.252,71	356,23	8,28	1470	1,00
HBF 90 T4 11kW (A3:8) F400 (°)	11	40,70	40,69	29.199,51	527,28	11,30	1470	1,00
HBF 90 T4 11kW (A3:8) F400 (°)	11	41,82	41,88	27.753,29	520,19	10,39	1470	1,00
HBF 90 T4 11kW (A3:8) F400 (°)	11	43,24	43,40	26.309,90	515,21	9,50	1470	1,00
HBF 90 T4 11kW (A3:8) F400 (°)	11	44,52	44,93	24.798,94	510,53	8,67	1470	1,00
HBF 90 T4 15kW (A3:8) F400 (°)	15	38,50	38,36	32.064,08	543,37	13,28	1465	1,00
HBF 90 T4 15kW (A3:8) F400 (°)	15	39,99	39,92	30.693,75	535,39	12,16	1465	1,00
HBF 100 T4 5,5kW (A3:4) F400 (°)	5,5	51,87	53,30	26.551,96	401	5,98	1450	1,00
HBF 100 T4 5,5kW (A3:4) F400 (°)	5,5	53,50	55,28	24.581,71	393,08	5,28	1450	1,00
HBF 100 T4 5,5kW (A3:4) F400 (°)	5,5	55,29	57,42	22.619,79	386,25	4,64	1450	1,00
HBF 100 T4 5,5kW (A3:4) F400 (°)	5,5	56,41	58,86	20.842,55	377,22	4,11	1450	1,00
HBF 100 T4 7,5kW (A3:4) F400 (°)	7,5	49,06	49,88	30.676,32	415,55	7,49	1453	1,00
HBF 100 T4 7,5kW (A3:4) F400 (°)	7,5	50,77	51,90	28.592,36	409,27	6,67	1453	1,00
HBF 100 T4 7,5kW (A3:8) F400 (°)	7,5	55,47	56,16	23.417,68	607,83	7,82	1453	1,00
HBF 100 T4 11kW (A3:4) F400 (°)	11	41,52	41,52	37.883,88	424,19	11,15	1470	1,00
HBF 100 T4 11kW (A3:4) F400 (°)	11	43,81	43,89	35.974,38	428,43	10,10	1470	1,00
HBF 100 T4 11kW (A3:4) F400 (°)	11	45,92	46,20	34.144,20	427,62	9,11	1470	1,00
HBF 100 T4 11kW (A3:4) F400 (°)	11	47,76	48,32	32.382,92	421,97	8,22	1470	1,00
HBF 100 T4 11kW (A3:8) F400 (°)	11	51,03	51,01	31.641,86	617,34	11,55	1470	1,00
HBF 100 T4 11kW (A3:8) F400 (°)	11	53,94	54,11	27.456,87	612,59	9,47	1470	1,00
HBF 100 T4 11kW (A3:8) F400 (°)	11	55,20	55,65	25.420,36	610,20	8,56	1470	1,00
HBF 100 T4 11kW (A3:8) F400 (°)	11	52,54	52,58	29.528,86	615,77	10,48	1470	1,00
HBF 100 T4 15kW (A3:4) F400 (°)	15	39,45	39,38	39.773,65	420,72	12,24	1465	1,00
HBF 100 T4 15kW (A3:8) F400 (°)	15	47,09	46,83	38.099,12	641,83	15,45	1465	1,00



Model	Motor power (kW)	Maximum efficiency point data						
		Max. efficiency (%)	Efficiency grade (N) (N)	Air Flow (m3/h)	Ps (Pa)	Pabs (kW)	speed (rpm)	Specific ratio
HBF 100 T4 15kW (A3:8) F400 (°)	15	48,58	48,41	35.858,39	631,14	13,92	1465	1,00
HBF 100 T4 15kW (A3:8) F400 (°)	15	50,05	49,95	33.667,23	620,57	12,57	1465	1,00
HBF 100 T4 18,5kW (A3:8) F400 (°)	18,5	43,92	43,51	42.881,99	657,50	18,71	1465	1,00
HBF 100 T4 18,5kW (A3:8) F400 (°)	18,5	45,47	45,14	40.435,64	650,15	17,04	1465	1,00
HBF 100 T4 22kW (A3:8) F400 (°)	22	42,42	41,94	45.506,86	663,64	20,54	1465	1,00
HBF 112 T4 5,5kW (A3:4) F400 (°)	5,5	58,57	60,07	25.650,99	454,24	5,82	1450	1,00
HBF 112 T4 7,5kW (A3:4) F400 (°)	7,5	57,62	58,79	28.722,21	445,68	6,56	1453	1,00
HBF 112 T4 7,5kW (A3:4) F400 (°)	7,5	56,18	57,03	31.958,45	439,65	7,40	1453	1,00
HBF 112 T4 11kW (A3:4) F400 (°)	11	50,77	50,76	45.167,47	447,36	11,30	1470	1,00
HBF 112 T4 11kW (A3:4) F400 (°)	11	52,52	52,59	42.650,78	440,51	10,20	1470	1,00
HBF 112 T4 11kW (A3:4) F400 (°)	11	54,03	54,29	38.950,75	437	9,18	1470	1,00
HBF 112 T4 11kW (A3:4) F400 (°)	11	55,47	56,03	35.408,75	436,25	8,21	1470	1,00
HBF 112 T4 11kW (A3:8) F400 (°)	11	59,52	59,49	33.497,64	695,11	11,64	1470	1,00
HBF 112 T4 11kW (A3:8) F400 (°)	11	59,41	59,44	30.195,59	708	10,66	1470	1,00
HBF 112 T4 15kW (A3:8) F400 (°)	15	57,78	57,60	40.666,11	670,97	14,07	1465	1,00
HBF 112 T4 15kW (A3:8) F400 (°)	15	59,10	58,99	37.062,48	681,23	12,72	1465	1,00
HBF 112 T4 15kW (A3:8) F400 (°)	15	56,50	56,24	44.285,27	663,23	15,50	1465	1,00
HBF 112 T4 18,5kW (A3:8) F400 (°)	18,5	53,40	52,98	51.076,20	674,33	18,96	1465	1,00
HBF 112 T4 18,5kW (A3:8) F400 (°)	18,5	55,48	55,15	47.984,32	657,81	16,90	1465	1,00
HBF 112 T4 22kW (A3:8) F400 (°)	22	51,62	51,12	54.223,31	690,24	21,10	1465	1,00
HBF 112 T4 22kW (A3:8) F400 (°)	22	49,77	49,20	57.042,61	699,22	23,14	1465	1,00
HBF 112 T4 30kW (A3:8) F400 (°)	30	46,45	45,76	62.509,16	704,62	27,06	1470	1,00
HBF 112 T4 30kW (A3:8) F400 (°)	30	48,48	47,85	59.738,16	701,78	24,86	1470	1,00
HBF 125 T4 11kW (A3:4) F400 (°)	11	58,21	58,24	38.867,01	544,20	10,72	1470	1,00
HBF 125 T4 11kW (A3:4) F400 (°)	11	59,70	59,89	34.627,57	555,89	9,43	1470	1,00
HBF 125 T4 15kW (A3:4) F400 (°)	15	54,41	54,17	52.641,94	533,79	15,06	1465	1,00
HBF 125 T4 15kW (A3:4) F400 (°)	15	55,99	55,85	47.908,39	532,86	13,44	1465	1,00
HBF 125 T4 15kW (A3:4) F400 (°)	15	57,13	57,08	43.235,32	536,37	12,01	1465	1,00
HBF 125 T4 18,5kW (A3:4) F400 (°)	18,5	51,38	50,99	60.950,03	546,90	18,40	1465	1,00
HBF 125 T4 18,5kW (A3:4) F400 (°)	18,5	53,14	52,83	57.616,06	538,43	16,65	1465	1,00
HBF 125 T4 18,5kW (A3:8) F400 (°)	18,5	60,33	59,91	45.513,87	844,37	18,92	1465	1,00
HBF 125 T4 18,5kW (A3:8) F400 (°)	18,5	60,17	59,82	40.816,50	865,45	17,39	1465	1,00
HBF 125 T4 22kW (A3:4) F400 (°)	22	46,40	45,84	67.695,79	552,09	22,74	1465	1,00
HBF 125 T4 22kW (A3:4) F400 (°)	22	49,42	48,94	64.631,14	554,34	20,49	1465	1,00
HBF 125 T4 22kW (A3:8) F400 (°)	22	59,65	59,16	50.101,18	832,37	20,84	1465	1,00
HBF 125 T4 22kW (A3:8) F400 (°)	22	58,26	57,69	54.888,01	820,52	23,04	1465	1,00
HBF 125 T4 30kW (A3:8) F400 (°)	30	55,98	55,28	64.842,17	805,03	27,60	1470	1,00
HBF 125 T4 30kW (A3:8) F400 (°)	30	57,49	56,85	59.887,35	810,69	25,16	1470	1,00



Model	Motor power (kW)	Maximum efficiency point data						
		Max. efficiency (%)	Efficiency grade (N) (N)	Air Flow (m3/h)	Ps (Pa)	Pabs (kW)	speed (rpm)	Specific ratio
HBF 125 T4 30kW (A3:8) F400 (°)	30	53,89	53,09	68.709,09	827,35	30,96	1470	1,00
HBF 125 T4 37kW (A3:8) F400 (°)	37	50,51	49,55	77.349,10	853,45	37,87	1475	1,00
HBF 125 T4 37kW (A3:8) F400 (°)	37	52,01	51,13	73.025,87	843,98	34,43	1475	1,00
HBF 125 T4 45kW (A3:8) F400 (°)	45	46,52	45,44	84.191,86	861,51	44,34	1475	1,00
HBF 125 T4 45kW (A3:8) F400 (°)	45	48,98	47,97	80.875,45	856,90	40,79	1475	1,00

ERP / 6 poles

Model	Motor power (kW)	Maximum efficiency point data						
		Max. efficiency (%)	Efficiency grade (N) (N)	Air Flow (m3/h)	Ps (Pa)	Pabs (kW)	speed (rpm)	Specific ratio
HBF 50 T6 0,75kW (A5:6) F400 (°)	0,75	26,51	37,89	3.801,51	49,14	0,16	923	1,00
HBF 56 T6 0,75kW (A5:6) F400 (°)	0,55	30,33	38,94	5.459,45	84,52	0,44	923	1,00
HBF 63 T6 0,75kW (A5:6) F400 (°)	0,55	34,06	41,69	7.615,85	94,49	0,62	923	1,00
HBF 71 T6 0,75kW (A5:6) F400 (°)	0,75	30,27	36,76	9.801,75	101,01	0,94	923	1,00
HBF 71 T6 0,75kW (A5:6) F400 (°)	0,75	31,83	38,57	9.342,20	101,35	0,86	923	1,00
HBF 71 T6 0,75kW (A5:6) F400 (°)	0,75	33,76	40,76	8.892	102,10	0,78	923	1,00
HBF 80 T6 0,75kW (A5:6) F400 (°)	0,75	46,42	53,13	10.781,95	130,20	0,87	923	1,00
HBF 80 T6 1,1kW (A5:6) F400 (°)	1,1	45,75	52,11	11.564,61	135,49	0,99	920	1,00
HBF 80 T6 1,1kW (A5:6) F400 (°)	1,1	45,38	51,44	12.346,06	140,98	1,11	920	1,00
HBF 80 T6 1,5kW (A5:6) F400 (°)	1,5	43,39	49,15	13.270,90	139,67	1,23	933	1,00
HBF 80 T6 1,5kW (A5:6) F400 (°)	1,5	42,03	47,52	14.230,04	138,45	1,36	933	1,00
HBF 80 T6 2,2kW (A5:6) F400 (°)	2,2	35,88	40,81	15.634,47	132,64	1,67	948	1,00
HBF 90 T6 1,5kW (A3:4) F400 (°)	1,5	44,99	51,97	9.583,78	124,98	0,79	933	1,00
HBF 90 T6 1,5kW (A3:4) F400 (°)	1,5	42,25	48,02	12.493,84	142,68	1,23	933	1,00
HBF 90 T6 1,5kW (A3:4) F400 (°)	1,5	44,95	51,55	10.556,97	131,26	0,91	933	1,00
HBF 90 T6 1,5kW (A3:4) F400 (°)	1,5	40,51	45,57	14.458,45	154,42	1,59	933	1,00
HBF 90 T6 1,5kW (A3:4) F400 (°)	1,5	43,62	49,78	11.508,58	137,15	1,06	933	1,00
HBF 90 T6 1,5kW (A3:4) F400 (°)	1,5	39,16	44	15.175,88	153,82	1,73	933	1,00
HBF 90 T6 1,5kW (A3:4) F400 (°)	1,5	41,76	47,18	13.448,72	148,79	1,39	933	1,00
HBF 90 T6 1,5kW (A3:8) F400 (°)	1,5	43,13	47,88	12.501,64	197,85	1,78	933	1,00
HBF 90 T6 1,5kW (A3:8) F400 (°)	1,5	44,11	49,24	11.328,69	193,42	1,55	933	1,00
HBF 90 T6 1,5kW (A3:8) F400 (°)	1,5	44,93	50,45	10.229,46	188,94	1,34	933	1,00
HBF 90 T6 2,2kW (A3:4) F400 (°)	2,2	36,98	41,41	16.731,31	152,65	2	948	1,00
HBF 90 T6 2,2kW (A3:4) F400 (°)	2,2	32,98	36,88	18.362,87	149,62	2,43	948	1,00
HBF 90 T6 2,2kW (A3:4) F400 (°)	2,2	34,92	39,08	17.489,63	151,36	2,20	948	1,00
HBF 90 T6 2,2kW (A3:4) F400 (°)	2,2	38,76	43,43	15.956,21	153,67	1,83	948	1,00



Model	Motor power (kW)	Maximum efficiency point data						
		Max. efficiency (%)	Efficiency grade (N) (N)	Air Flow (m3/h)	Ps (Pa)	Pabs (kW)	speed (rpm)	Specific ratio
HBF 90 T6 2,2kW (A3:8) F400 (°)	2,2	41,21	44,98	16.064,98	214,09	2,54	948	1,00
HBF 90 T6 2,2kW (A3:8) F400 (°)	2,2	42,13	46,22	14.838,62	208,75	2,26	948	1,00
HBF 90 T6 2,2kW (A3:8) F400 (°)	2,2	43,04	47,49	13.628,47	203,46	1,99	948	1,00
HBF 90 T6 3kW (A3:8) F400 (°)	3	38,31	41,40	18.908,19	221,14	3,26	965	1,00
HBF 90 T6 3kW (A3:8) F400 (°)	3	39,43	42,75	18.011,07	218,50	3	965	1,00
HBF 90 T6 3kW (A3:8) F400 (°)	3	40,73	44,29	17.055,17	216,34	2,75	965	1,00
HBF 90 T6 4kW (A3:8) F400 (°)	4	36,47	39,13	20.775,85	228	3,81	963	1,00
HBF 90 T6 4kW (A3:8) F400 (°)	4	37,78	40,68	19.832,49	224,67	3,50	963	1,00
HBF 100 T6 1,5kW (A3:4) F400 (°)	1,5	48	52,79	17.179,76	168,57	1,76	933	1,00
HBF 100 T6 1,5kW (A3:4) F400 (°)	1,5	51,69	57,48	13.485,58	158,21	1,22	933	1,00
HBF 100 T6 1,5kW (A3:4) F400 (°)	1,5	49,51	54,63	15.922,72	165,18	1,55	933	1,00
HBF 100 T6 1,5kW (A3:4) F400 (°)	1,5	51,08	56,56	14.653,56	161,73	1,36	933	1,00
HBF 100 T6 2,2kW (A3:4) F400 (°)	1,5	48	52,79	17.179,76	168,57	1,76	948	1,00
HBF 100 T6 2,2kW (A3:4) F400 (°)	1,5	51,69	57,48	13.485,58	158,21	1,22	948	1,00
HBF 100 T6 2,2kW (A3:4) F400 (°)	2,2	44,23	48,15	20.995,57	176,96	2,42	948	1,00
HBF 100 T6 2,2kW (A3:4) F400 (°)	2,2	45,96	50,16	19.862,23	174,86	2,18	948	1,00
HBF 100 T6 2,2kW (A3:4) F400 (°)	2,2	47,55	52,06	18.545,55	171,45	1,94	948	1,00
HBF 100 T6 2,2kW (A3:4) F400 (°)	1,5	49,51	54,63	15.922,72	165,18	1,55	948	1,00
HBF 100 T6 2,2kW (A3:4) F400 (°)	1,5	51,08	56,56	14.653,56	161,73	1,36	948	1,00
HBF 100 T6 2,2kW (A3:8) F400 (°)	2,2	51,21	55,01	16.476,91	256,68	2,51	948	1,00
HBF 100 T6 2,2kW (A3:8) F400 (°)	2,2	51,92	55,99	15.169,13	255,11	2,28	948	1,00
HBF 100 T6 3kW (A3:4) F400 (°)	3	38,98	42,10	24.548,30	178	3,23	965	1,00
HBF 100 T6 3kW (A3:4) F400 (°)	3	43,18	46,85	22.123,26	179,46	2,64	965	1,00
HBF 100 T6 3kW (A3:4) F400 (°)	3	41,08	44,48	23.289,51	179,45	2,92	965	1,00
HBF 100 T6 3kW (A3:8) F400 (°)	3	50,84	54,42	17.792,04	257,31	2,74	965	1,00
HBF 100 T6 3kW (A3:8) F400 (°)	3	47,99	51,02	20.468,71	259,15	3,34	965	1,00
HBF 100 T6 3kW (A3:8) F400 (°)	3	49,37	52,67	19.128,02	258,39	3,03	965	1,00
HBF 100 T6 4kW (A3:4) F400 (°)	4	37,30	40,18	25.772,81	176,56	3,52	963	1,00
HBF 100 T6 4kW (A3:8) F400 (°)	4	44,50	46,75	24.680,80	269,11	4,44	963	1,00
HBF 100 T6 4kW (A3:8) F400 (°)	4	45,88	48,41	23.240,09	265,30	4,01	963	1,00
HBF 100 T6 4kW (A3:8) F400 (°)	4	47,24	50,05	21.823,06	259,99	3,61	963	1,00
HBF 100 T6 5,5kW (A3:8) F400 (°)	5,5	43,47	45,48	26.154,22	273,04	4,85	960	1,00
HBF 100 T6 5,5kW (A3:8) F400 (°)	5,5	40,35	41,83	29.503,31	278,58	5,88	960	1,00
HBF 100 T6 5,5kW (A3:8) F400 (°)	5,5	41,89	43,63	27.803,89	275,54	5,34	960	1,00
HBF 112 T6 2,2kW (A3:4) F400 (°)	2,2	51,44	55,36	22.980,29	183,02	2,41	948	1,00
HBF 112 T6 2,2kW (A3:4) F400 (°)	2,2	52,53	56,76	20.748,94	183,87	2,15	948	1,00
HBF 112 T6 2,2kW (A3:4) F400 (°)	2,2	53,88	58,45	18.574,72	187,51	1,91	948	1,00
HBF 112 T6 2,2kW (A3:4) F400 (°)	2,2	54,23	59,09	16.623,41	190,80	1,71	948	1,00



Model	Motor power (kW)	Maximum efficiency point data						
		Max. efficiency (%)	Efficiency grade (N) (N)	Air Flow (m3/h)	Ps (Pa)	Pabs (kW)	speed (rpm)	Specific ratio
HBF 112 T6 3kW (A3:4) F400 (°)	3	50,81	54,47	25.245,67	183,08	2,66	965	1,00
HBF 112 T6 3kW (A3:4) F400 (°)	3	47,73	50,82	29.265,33	187,47	3,26	965	1,00
HBF 112 T6 3kW (A3:4) F400 (°)	3	49,40	52,76	27.623,78	184,84	2,95	965	1,00
HBF 112 T6 3kW (A3:8) F400 (°)	3	56	59,01	21.778,10	290,64	3,36	965	1,00
HBF 112 T6 3kW (A3:8) F400 (°)	3	55,92	59,16	19.608,60	296,90	3,08	965	1,00
HBF 112 T6 4kW (A3:4) F400 (°)	4	40,84	43,13	33.937,50	184,85	4,37	963	1,00
HBF 112 T6 4kW (A3:4) F400 (°)	4	43,64	46,18	32.509,70	189,55	3,99	963	1,00
HBF 112 T6 4kW (A3:4) F400 (°)	4	46,20	49,02	30.958,51	190,42	3,60	963	1,00
HBF 112 T6 4kW (A3:8) F400 (°)	4	53,43	55,66	28.677,77	278,34	4,46	963	1,00
HBF 112 T6 4kW (A3:8) F400 (°)	4	54,62	57,12	26.316,98	281,58	4,05	963	1,00
HBF 112 T6 4kW (A3:8) F400 (°)	4	55,86	58,64	24.040,42	285,48	3,66	963	1,00
HBF 112 T6 5,5kW (A3:4) F400 (°)	5,5	38,56	40,63	35.410,86	180,06	4,74	960	1,00
HBF 112 T6 5,5kW (A3:8) F400 (°)	5,5	52,93	54,95	31.076,68	276,36	4,82	960	1,00
HBF 112 T6 5,5kW (A3:8) F400 (°)	5,5	49,03	50,43	35.104,47	289,64	6,04	960	1,00
HBF 112 T6 5,5kW (A3:8) F400 (°)	5,5	50,96	52,67	33.100,89	283,06	5,40	960	1,00
HBF 112 T6 7,5kW (A3:8) F400 (°)	7,5	46,28	47,24	38.694,32	294,24	7,08	970	1,00
HBF 112 T6 7,5kW (A3:8) F400 (°)	7,5	47,84	49,02	36.964,24	293,63	6,55	970	1,00
HBF 112 T6 7,5kW (A3:8) F400 (°)	7,5	44,41	45,14	40.492,81	295,56	7,70	970	1,00
HBF 125 T6 3kW (A3:4) F400 (°)	3	53,40	56,30	28.018,57	225,20	3,50	965	1,00
HBF 125 T6 3kW (A3:4) F400 (°)	3	54,75	57,98	25.151,44	228,34	3,10	965	1,00
HBF 125 T6 3kW (A3:4) F400 (°)	3	56,19	59,78	22.380,14	234,07	2,72	965	1,00
HBF 125 T6 4kW (A3:4) F400 (°)	4	52,93	55,56	31.002,15	223,93	3,87	963	1,00
HBF 125 T6 4kW (A3:4) F400 (°)	4	51,57	53,88	34.126,02	224,01	4,32	963	1,00
HBF 125 T6 5,5kW (A3:4) F400 (°)	5,5	46,86	48,34	41.817,50	232,85	5,87	960	1,00
HBF 125 T6 5,5kW (A3:4) F400 (°)	5,5	49,08	50,87	39.514,98	229,55	5,24	960	1,00
HBF 125 T6 5,5kW (A3:4) F400 (°)	5,5	50,80	52,87	37.300,23	226,18	4,74	960	1,00
HBF 125 T6 5,5kW (A3:8) F400 (°)	5,5	56,65	58,09	32.472,13	349,36	5,96	960	1,00
HBF 125 T6 5,5kW (A3:8) F400 (°)	5,5	57,62	59,33	29.427,43	355,11	5,39	960	1,00
HBF 125 T6 5,5kW (A3:8) F400 (°)	5,5	57,44	59,39	26.471,98	362,86	4,95	960	1,00
HBF 125 T6 7,5kW (A3:8) F400 (°)	7,5	53,64	54,32	42.032,28	337,28	7,86	970	1,00
HBF 125 T6 7,5kW (A3:8) F400 (°)	7,5	54,83	55,77	38.760,28	340,40	7,17	970	1,00
HBF 125 T6 7,5kW (A3:8) F400 (°)	7,5	56,09	57,28	35.571,49	344,23	6,51	970	1,00
HBF 125 T6 11kW (A3:8) F400 (°)	11	46,87	46,84	52.275,06	360,26	11,53	970	1,00
HBF 125 T6 11kW (A3:8) F400 (°)	11	48,44	48,48	49.919,01	358,48	10,67	970	1,00
HBF 125 T6 11kW (A3:8) F400 (°)	11	50,25	50,35	47.408,37	353,84	9,71	970	1,00
HBF 125 T6 11kW (A3:8) F400 (°)	11	52,34	52,75	44.711,09	346,17	8,69	970	1,00
HBF 125 T6 15kW (A3:8) F400 (°)	15	45,55	45,47	54.803,88	361,22	12,43	970	1,00

ERP / 4/8 poles

Model	Motor power (kW)	Maximum efficiency point data						
		Max. efficiency (%)	Efficiency grade (N) (N)	Air Flow (m3/h)	Ps (Pa)	Pabs (kW)	speed (rpm)	Specific ratio
HBF 45 T4/T8 0,8/0,2kW (A5:6) F400 (°)	0,8/0,2	25,22	34,25	3.938,40	91,48	0,37	1500	1,00
HBF 50 T4/T8 0,8/0,2kW (A5:6) F400 (°)	0,8/0,2	33,75	41,93	5.631,13	108,38	0,51	1500	1,00
HBF 56 T4/T8 0,8/0,2kW (A5:6) F400 (°)	0,8/0,2	38,49	46,08	5.286,46	156,65	0,63	1500	1,00
HBF 56 T4/T8 0,8/0,2kW (A5:6) F400 (°)	0,8/0,2	38,91	45,71	6.799,71	163,76	0,84	1500	1,00
HBF 56 T4/T8 0,8/0,2kW (A5:6) F400 (°)	0,8/0,2	40,36	47,48	6.377,29	162,70	0,75	1500	1,00
HBF 56 T4/T8 1,2/0,3kW (A5:6) F400 (°)	1,2/0,3	35,94	41,99	7.864,11	175,27	1,11	1500	1,00
HBF 56 T4/T8 1,2/0,3kW (A5:6) F400 (°)	1,2/0,3	37,33	43,85	7.198,19	163,79	0,93	1500	1,00
HBF 56 T4/T8 1,6/0,4kW (A5:6) F400 (°)	1,6/0,4	35,35	41	8.575,19	185,04	1,28	1500	1,00
HBF 56 T4/T8 1,6/0,4kW (A5:6) F400 (°)	1,6/0,4	35,43	40,72	9.299,95	193,09	1,46	1500	1,00
HBF 63 T4/T8 0,8/0,2kW (A5:6) F400 (°)	0,8/0,2	46,63	53,25	7.384,78	192,08	0,90	1500	1,00
HBF 63 T4/T8 1,2/0,3kW (A5:6) F400 (°)	1,2/0,3	46,52	52,17	9.056,31	221,36	1,28	1500	1,00
HBF 63 T4/T8 1,6/0,4kW (A5:6) F400 (°)	1,6/0,4	42,12	47,20	10.066,20	229,21	1,58	1500	1,00
HBF 63 T4/T8 1,6/0,4kW (A5:6) F400 (°)	1,6/0,4	44,39	49,74	9.588,71	224,77	1,43	1500	1,00
HBF 63 T4/T8 2,2/0,37kW (A5:6) F400 (°)	2,2/0,37	38,35	42,73	11.588,88	230,37	2,03	1500	1,00
HBF 63 T4/T8 2,2/0,37kW (A5:6) F400 (°)	2,2/0,37	40,03	44,74	10.830,65	229,31	1,81	1500	1,00
HBF 71 T4/T8 0,8/0,2kW (A5:6) F400 (°)	0,8/0,2	47,01	53,39	7.908,74	201,69	0,98	1500	1,00
HBF 71 T4/T8 1,2/0,3kW (A5:6) F400 (°)	1,2/0,3	45,67	51,11	9.865,86	221,15	1,39	1500	1,00
HBF 71 T4/T8 1,6/0,4kW (A5:6) F400 (°)	1,6/0,4	46,22	50,95	11.855,32	240,58	1,80	1500	1,00
HBF 71 T4/T8 2,2/0,37kW (A5:6) F400 (°)	2,2/0,37	42,32	46,19	14.007,05	256,86	2,46	1500	1,00
HBF 71 T4/T8 2,2/0,37kW (A5:6) F400 (°)	2,2/0,37	43,85	48,11	12.922	248,26	2,13	1500	1,00
HBF 71 T4/T8 3/0,55kW (A5:6) F400 (°)	3/0,55	39,37	42,79	15.295,05	255,96	2,89	1500	1,00
HBF 71 T4/T8 3/0,55kW (A5:6) F400 (°)	3/0,55	40,72	44,36	14.637,66	255,51	2,67	1500	1,00
HBF 80 T4/T8 3/0,55kW (A5:6) F400 (°)	3/0,55	47,47	50,44	18.603,39	298,09	3,41	1500	1,00
HBF 80 T4/T8 3/0,55kW (A5:6) F400 (°)	3/0,55	49,89	53,19	17.421,07	297,07	3,02	1500	1,00
HBF 80 T4/T8 3/0,55kW (A5:6) F400 (°)	3/0,55	53,27	56,95	16.269,95	295,38	2,63	1500	1,00
HBF 80 T4/T8 4/0,75kW (A5:6) F400 (°)	4/0,75	46,01	48,67	20.008,80	305,30	3,81	1500	1,00
HBF 80 T4/T8 4/0,75kW (A5:6) F400 (°)	4/0,75	45,44	47,83	21.569,23	310,17	4,22	1500	1,00
HBF 90 T4/T8 2,8/0,7kW (A3:4) F400 (°)	2,8/0,7	48,40	51,64	16.269,79	312,06	3,09	1420	1,00
HBF 90 T4/T8 2,8/0,7kW (A3:4) F400 (°)	2,8/0,7	49,88	53,58	14.806,82	298,15	2,61	1420	1,00
HBF 90 T4/T8 4/0,75kW (A3:4) F400 (°)	4/0,75	46,06	48,49	19.259,13	340,14	4,15	1420	1,00
HBF 90 T4/T8 4/0,75kW (A3:4) F400 (°)	4/0,75	47,50	50,34	17.768,06	326,89	3,58	1420	1,00
HBF 90 T4/T8 5,5/1,1kW (A3:4) F400 (°)	5,5/1,1	43,92	45,63	22.345,93	367,81	5,41	1420	1,00
HBF 90 T4/T8 5,5/1,1kW (A3:4) F400 (°)	5,5/1,1	45,22	47,29	20.822,29	353,92	4,73	1420	1,00
HBF 90 T4/T8 5,5/1,1kW (A3:4) F400 (°)	5,5/1,1	42,44	43,93	23.455,15	367,14	5,86	1420	1,00
HBF 90 T4/T8 5,5/1,1kW (A3:8) F400 (°)	5,5/1,1	47,68	49,45	17.497,66	461,40	5,27	1420	1,00
HBF 90 T4/T8 5,5/1,1kW (A3:8) F400 (°)	5,5/1,1	48,67	50,84	15.786,74	450,04	4,57	1420	1,00

Model	Motor power (kW)	Maximum efficiency point data						
		Max. efficiency (%)	Efficiency grade (N) (N)	Air Flow (m3/h)	Ps (Pa)	Pabs (kW)	speed (rpm)	Specific ratio
HBF 90 T4/T8 7,5/1,5kW (A3:4) F400 (°)	7,5/1,5	41,38	42,67	24.607,17	366,35	6,30	1420	1,00
HBF 90 T4/T8 7,5/1,5kW (A3:4) F400 (°)	7,5/1,5	37,31	38,09	27.009,72	360,41	7,58	1420	1,00
HBF 90 T4/T8 7,5/1,5kW (A3:4) F400 (°)	7,5/1,5	39,50	40,55	25.787,41	364,05	6,88	1420	1,00
HBF 90 T4/T8 7,5/1,5kW (A3:4) F400 (°)	7,5/1,5	42,44	43,93	23.455,15	367,14	5,86	1420	1,00
HBF 90 T4/T8 7,5/1,5kW (A3:8) F400 (°)	7,5/1,5	45,05	45,76	22.907,92	496,52	7,76	1420	1,00
HBF 90 T4/T8 7,5/1,5kW (A3:8) F400 (°)	7,5/1,5	46,06	47,13	21.070,55	483,55	6,84	1420	1,00
HBF 90 T4/T8 7,5/1,5kW (A3:8) F400 (°)	7,5/1,5	46,56	47,96	19.242,52	472,46	6,05	1420	1,00
HBF 90 T4/T8 11/3kW (A3:4) F400 (°)	11/3	35,47	36,01	28.252,71	356,23	8,28	1420	1,00
HBF 90 T4/T8 11/3kW (A3:8) F400 (°)	11/3	40,70	40,69	29.199,51	527,28	11,30	1420	1,00
HBF 90 T4/T8 11/3kW (A3:8) F400 (°)	11/3	41,82	41,88	27.753,29	520,19	10,39	1420	1,00
HBF 90 T4/T8 11/3kW (A3:8) F400 (°)	11/3	43,24	43,40	26.309,90	515,21	9,50	1420	1,00
HBF 90 T4/T8 11/3kW (A3:8) F400 (°)	11/3	44,52	44,93	24.798,94	510,53	8,67	1420	1,00
HBF 90 T4/T8 14/3,5kW (A3:8) F400 (°)	14/3,5	38,50	38,36	32.064,08	543,37	13,28	1420	1,00
HBF 90 T4/T8 14/3,5kW (A3:8) F400 (°)	14/3,5	39,99	39,92	30.693,75	535,39	12,16	1420	1,00
HBF 100 T4/T8 5,5/1,1kW (A3:4) F400 (°)	5,5/1,1	51,87	53,30	26.551,96	401	5,98	1420	1,00
HBF 100 T4/T8 5,5/1,1kW (A3:4) F400 (°)	5,5/1,1	53,50	55,28	24.581,71	393,08	5,28	1420	1,00
HBF 100 T4/T8 5,5/1,1kW (A3:4) F400 (°)	5,5/1,1	55,29	57,42	22.619,79	386,25	4,64	1420	1,00
HBF 100 T4/T8 5,5/1,1kW (A3:4) F400 (°)	5,5/1,1	56,41	58,86	20.842,55	377,22	4,11	1420	1,00
HBF 100 T4/T8 7,5/1,5kW (A3:4) F400 (°)	7,5/1,5	49,06	49,88	30.676,32	415,55	7,49	1420	1,00
HBF 100 T4/T8 7,5/1,5kW (A3:4) F400 (°)	7,5/1,5	50,77	51,90	28.592,36	409,27	6,67	1420	1,00
HBF 100 T4/T8 7,5/1,5kW (A3:8) F400 (°)	7,5/1,5	55,47	56,16	23.417,68	607,83	7,82	1420	1,00
HBF 100 T4/T8 11/3kW (A3:4) F400 (°)	11/3	41,52	41,52	37.883,88	424,19	11,15	1420	1,00
HBF 100 T4/T8 11/3kW (A3:4) F400 (°)	11/3	43,81	43,89	35.974,38	428,43	10,10	1420	1,00
HBF 100 T4/T8 11/3kW (A3:4) F400 (°)	11/3	45,92	46,20	34.144,20	427,62	9,11	1420	1,00
HBF 100 T4/T8 11/3kW (A3:4) F400 (°)	11/3	47,76	48,32	32.382,92	421,97	8,22	1420	1,00
HBF 100 T4/T8 11/3kW (A3:8) F400 (°)	11/3	51,03	51,01	31.641,86	617,34	11,55	1420	1,00
HBF 100 T4/T8 11/3kW (A3:8) F400 (°)	11/3	53,94	54,11	27.456,87	612,59	9,47	1420	1,00
HBF 100 T4/T8 11/3kW (A3:8) F400 (°)	11/3	55,20	55,65	25.420,36	610,20	8,56	1420	1,00
HBF 100 T4/T8 11/3kW (A3:8) F400 (°)	11/3	52,54	52,58	29.528,86	615,77	10,48	1420	1,00
HBF 100 T4/T8 14/3,5kW (A3:4) F400 (°)	14/3,5	39,45	39,38	39.773,65	420,72	12,24	1420	1,00
HBF 100 T4/T8 14/3,5kW (A3:8) F400 (°)	14/3,5	48,58	48,41	35.858,39	631,14	13,92	1420	1,00
HBF 100 T4/T8 14/3,5kW (A3:8) F400 (°)	14/3,5	50,05	49,95	33.667,23	620,57	12,57	1420	1,00
HBF 100 T4/T8 17/4,3kW (A3:8) F400 (°)	17/4,3	45,47	45,14	40.435,64	650,15	17,04	1420	1,00
HBF 100 T4/T8 17/4,3kW (A3:8) F400 (°)	17/4,3	47,09	46,83	38.099,12	641,83	15,45	1420	1,00
HBF 100 T4/T8 20/5kW (A3:8) F400 (°)	20/5	43,92	43,51	42.881,99	657,50	18,71	1420	1,00
HBF 100 T4/T8 20/5kW (A3:8) F400 (°)	20/5	42,42	41,94	45.506,86	663,64	20,54	1420	1,00
HBF 112 T4/T8 5,5/1,1kW (A3:4) F400 (°)	5,5/1,1	58,57	60,07	25.650,99	454,24	5,82	1420	1,00
HBF 112 T4/T8 7,5/1,5kW (A3:4) F400 (°)	7,5/1,5	57,62	58,79	28.722,21	445,68	6,56	1420	1,00



Model	Motor power (kW)	Maximum efficiency point data						
		Max. efficiency (%)	Efficiency grade (N) (N)	Air Flow (m3/h)	Ps (Pa)	Pabs (kW)	speed (rpm)	Specific ratio
HBF 112 T4/T8 7,5/1,5kW (A3:4) F400 (°)	7,5/1,5	56,18	57,03	31.958,45	439,65	7,40	1420	1,00
HBF 112 T4/T8 11/3kW (A3:4) F400 (°)	11/3	50,77	50,76	45.167,47	447,36	11,30	1420	1,00
HBF 112 T4/T8 11/3kW (A3:4) F400 (°)	11/3	52,52	52,59	42.650,78	440,51	10,20	1420	1,00
HBF 112 T4/T8 11/3kW (A3:4) F400 (°)	11/3	54,03	54,29	38.950,75	437	9,18	1420	1,00
HBF 112 T4/T8 11/3kW (A3:4) F400 (°)	11/3	55,47	56,03	35.408,75	436,25	8,21	1420	1,00
HBF 112 T4/T8 11/3kW (A3:8) F400 (°)	11/3	59,41	59,44	30.195,59	708	10,66	1420	1,00
HBF 112 T4/T8 14/3,5kW (A3:4) F400 (°)	14/3,5	48,91	48,82	47.787,36	454,15	12,54	1420	1,00
HBF 112 T4/T8 14/3,5kW (A3:4) F400 (°)	14/3,5	46,10	45,93	50.091,11	451,84	13,88	1420	1,00
HBF 112 T4/T8 14/3,5kW (A3:8) F400 (°)	14/3,5	57,78	57,60	40.666,11	670,97	14,07	1420	1,00
HBF 112 T4/T8 14/3,5kW (A3:8) F400 (°)	14/3,5	59,10	58,99	37.062,48	681,23	12,72	1420	1,00
HBF 112 T4/T8 14/3,5kW (A3:8) F400 (°)	14/3,5	59,52	59,49	33.497,64	695,11	11,64	1420	1,00
HBF 112 T4/T8 17/4,3kW (A3:8) F400 (°)	17/4,3	55,48	55,15	47.984,32	657,81	16,90	1420	1,00
HBF 112 T4/T8 17/4,3kW (A3:8) F400 (°)	17/4,3	56,50	56,24	44.285,27	663,23	15,50	1420	1,00
HBF 112 T4/T8 20/5kW (A3:8) F400 (°)	20/5	53,40	52,98	51.076,20	674,33	18,96	1420	1,00
HBF 112 T4/T8 28/6,5kW (A3:8) F400 (°)	28/6,5	51,62	51,12	54.223,31	690,24	21,10	1420	1,00
HBF 112 T4/T8 28/6,5kW (A3:8) F400 (°)	28/6,5	46,45	45,76	62.509,16	704,62	27,06	1420	1,00
HBF 112 T4/T8 28/6,5kW (A3:8) F400 (°)	28/6,5	48,48	47,85	59.738,16	701,78	24,86	1420	1,00
HBF 112 T4/T8 28/6,5kW (A3:8) F400 (°)	28/6,5	49,77	49,20	57.042,61	699,22	23,14	1420	1,00
HBF 125 T4/T8 11/3kW (A3:4) F400 (°)	11/3	58,21	58,24	38.867,01	544,20	10,72	1420	1,00
HBF 125 T4/T8 11/3kW (A3:4) F400 (°)	11/3	59,70	59,89	34.627,57	555,89	9,43	1420	1,00
HBF 125 T4/T8 14/3,5kW (A3:4) F400 (°)	14/3,5	55,99	55,85	47.908,39	532,86	13,44	1420	1,00
HBF 125 T4/T8 14/3,5kW (A3:4) F400 (°)	14/3,5	57,13	57,08	43.235,32	536,37	12,01	1420	1,00
HBF 125 T4/T8 17/4,3kW (A3:4) F400 (°)	17/4,3	54,41	54,17	52.641,94	533,79	15,06	1420	1,00
HBF 125 T4/T8 17/4,3kW (A3:4) F400 (°)	17/4,3	53,14	52,83	57.616,06	538,43	16,65	1420	1,00
HBF 125 T4/T8 20/5kW (A3:4) F400 (°)	20/5	49,42	48,94	64.631,14	554,34	20,49	1420	1,00
HBF 125 T4/T8 20/5kW (A3:4) F400 (°)	20/5	51,38	50,99	60.950,03	546,90	18,40	1420	1,00
HBF 125 T4/T8 20/5kW (A3:8) F400 (°)	20/5	59,65	59,16	50.101,18	832,37	20,84	1420	1,00
HBF 125 T4/T8 20/5kW (A3:8) F400 (°)	20/5	60,33	59,91	45.513,87	844,37	18,92	1420	1,00
HBF 125 T4/T8 20/5kW (A3:8) F400 (°)	20/5	60,17	59,82	40.816,50	865,45	17,39	1420	1,00
HBF 125 T4/T8 28/6,5kW (A3:8) F400 (°)	28/6,5	55,98	55,28	64.842,17	805,03	27,60	1420	1,00
HBF 125 T4/T8 28/6,5kW (A3:8) F400 (°)	28/6,5	57,49	56,85	59.887,35	810,69	25,16	1420	1,00
HBF 125 T4/T8 28/6,5kW (A3:8) F400 (°)	28/6,5	58,26	57,69	54.888,01	820,52	23,04	1420	1,00
HBF 125 T4/T8 37/9,2kW (A3:8) F400 (°)	37/9,2	50,51	49,55	77.349,10	853,45	37,87	1420	1,00
HBF 125 T4/T8 37/9,2kW (A3:8) F400 (°)	37/9,2	52,01	51,13	73.025,87	843,98	34,43	1420	1,00
HBF 125 T4/T8 37/9,2kW (A3:8) F400 (°)	37/9,2	53,89	53,09	68.709,09	827,35	30,96	1420	1,00
HBF 125 T4/T8 44/11kW (A3:8) F400 (°)	44/11	46,52	45,44	84.191,86	861,51	44,34	1420	1,00
HBF 125 T4/T8 44/11kW (A3:8) F400 (°)	44/11	48,98	47,97	80.875,45	856,90	40,79	1420	1,00

