

HM



LONG CASED VARIABLE PITCHBLADES

MANUFACTURING FEATURES:

- Reinforced fan casing manufactured in rolling steel sheet.
- Motor-impeller modular assembly for complete versatility.
- Epoxy powder finishing coat.
- Standard asynchronous squirrel-cage motor with IP-55 protection and Class F insulation. Manufactured with standard voltages: 230V 50Hz in single phase motors and 230/400V 50Hz in three phase motors up to 4kW and 400/690V 50Hz for higher powers.
- HM : Polyamide impeller with variable pitch angle reinforced with fibreglass
- HMA : Cast aluminium impeller with variable pitch angle.

APPLICATIONS:

Designed for inline installation, they are suitable for:

- Air renewal in buildings and industries.
- Smoke extraction (max 50-60°C).
- Maximum working temperature: 1ph 50°C, 3ph 60°C.

UNDER REQUEST:

- 100% reversible impeller.
- 60Hz fans and special voltages.
- Hot-dipped galvanised or stainless steel housing.

Accessories



AC BA-400 BAD CPM



FILTRO EMC INT PC2 PCP

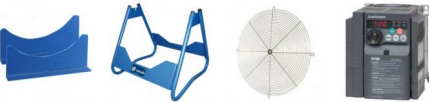

PO PS RP SFC



SIL-C / SIL-CN TIAC

## Technical data

### Single-phase motor / 2 poles

Code	Model	R.P.M.	Rated I. (A) 230V	Rated power kW	Max. Airflow m3/h	Sound db (A)*	Weight	Connect. diagram
26136306__P	HM 35 M2 0,55kW (A0:6)	2800	3,71	0,55	4.690	59	16	1
26139306__P	HM 35 M2 1,1kW (A0:6)	2800	6,71	1,10	5.760	57	16	1

### Single-phase motor / 4 poles

Code	Model	R.P.M.	Rated I. (A) 230V	Rated power kW	Max. Airflow m3/h	Sound db (A)*	Weight	Connect. diagram
26135306__P	HM 35 M4 0,12kW (A0:6)	1380	1,15	0,12	3.100	42	12	1
26140306__P	HM 40 M4 0,25kW (A0:6)	1400	1,93	0,25	4.690	48	19	1
26145306__P	HM 45 M4 0,37kW (A0:6)	1400	2,82	0,37	6.610	53	21	1
26150306__P	HM 50 M4 0,55kW (A0:6)	1400	3,98	0,55	9.320	52	29	1
26157356__P	HM 56 M4 0,37kW (A5:6)	1400	2,82	0,37	7.230	58	55	1
26158326__P	HM 56 M4 0,55kW (A2:6)	1400	3,98	0,55	8.290	56	57	1
26158356__P	HM 56 M4 0,55kW (A5:6)	1400	3,98	0,55	8.680	58	57	1

### Single-phase motor / 6 poles

Code	Model	R.P.M.	Rated I. (A) 230V	Rated power kW	Max. Airflow m3/h	Sound db (A)*	Weight	Connect. diagram
26143306__P	HM 40 M6 0,04kW (A0:6)	920	0,6	0,04	2.760	36	15	1
26149306__P	HM 45 M6 0,13kW (A0:6)	920	1,3	0,13	4.710	41	18	1
26152306__P	HM 50 M6 0,13kW (A0:6)	920	1,3	0,13	6.040	43	27	1
26156326__P	HM 56 M6 0,25kW (A2:6)	870	2,42	0,25	7.710	45	55	1
26156356__P	HM 56 M6 0,25kW (A5:6)	870	2,42	0,25	7.700	47	55	1
26157326__P	HM 56 M6 0,37kW (A2:6)	890	2,9	0,37	9.000	46	55	1
26157356__P	HM 56 M6 0,37kW (A5:6)	890	2,9	0,37	8.770	47	55	1
26163356__P	HM 63 M6 0,37kW (A5:6)	890	2,9	0,37	10.760	49	63	1
26164329__P	HM 63 M6 0,55kW (A2:9)	890	3,9	0,55	11.900	49	68	1
26164356__P	HM 63 M6 0,55kW (A5:6)	890	3,9	0,55	12.050	49	64	1
26171326__P	HM 71 M6 0,55kW (A2:6)	890	3,9	0,55	15.500	49	73	1
26171329__P	HM 71 M6 0,55kW (A2:9)	890	3,9	0,55	12.700	53	73	1

### Three-phase motor / 2 poles

Code	Model	R.P.M.	Rated I. (A) 400V	Rated power kW	Max. Airflow m3/h	Sound db (A)*	Weight	Connect. diagram
26136606__P	HM 35 T2 0,55kW (A0:6)	2800	1,29	0,55	4.690	59	16	2
26139606__P	HM 35 T2 1,1kW (A0:6)	2800	2,33	1,10	5.760	57	16	2
26142606__P	HM 40 T2 1,1kW (A0:6)	2800	2,33	1,10	7.850	61	25	2
26144694__P	HM 45 T2 0,75kW (A9:4)	2800	1,58	0,75	7.860	67	23	2
26143694__P	HM 45 T2 1,1kW (A9:4)	2800	2,33	1,10	9.160	61	25	2
26143698__P	HM 45 T2 1,1kW (A9:8)	2800	2,33	1,10	7.850	72	25	2
26146606__P	HM 45 T2 1,5kW (A0:6)	2865	3,14	1,50	9.560	68	29	2
26146694__P	HM 45 T2 1,5kW (A9:4)	2865	3,14	1,50	11.000	61	29	2
26146698__P	HM 45 T2 1,5kW (A9:8)	2865	3,14	1,50	9.460	66	30	2
26148606__P	HM 45 T2 2,2kW (A0:6)	2840	4,58	2,20	12.160	63	32	2
26148694__P	HM 45 T2 2,2kW (A9:4)	2840	4,58	2,20	13.400	61	31	2
26148698__P	HM 45 T2 2,2kW (A9:8)	2840	4,58	2,20	11.600	64	32	2
26149694__P	HM 45 T2 3kW (A9:4)	2880	5,92	3	14.200	66	39	2
26149698__P	HM 45 T2 3kW (A9:8)	2880	5,92	3	13.100	62	40	2
26153694__P	HM 50 T2 1,1kW (A9:4)	2800	2,33	1,10	9.800	72	29	2
26154694__P	HM 50 T2 1,5kW (A9:4)	2865	3,14	1,50	11.900	66	33	2
26154698__P	HM 50 T2 1,5kW (A9:8)	2865	3,14	1,50	10.000	72	33	2
26155694__P	HM 50 T2 2,2kW (A9:4)	2840	4,58	2,20	15.800	63	35	2
26155698__P	HM 50 T2 2,2kW (A9:8)	2840	4,58	2,20	12.400	67	37	2
26152694__P	HM 50 T2 3kW (A9:4)	2880	5,92	3	17.600	65	43	2
26152698__P	HM 50 T2 3kW (A9:8)	2880	5,92	3	15.300	66	43	2
26151694__P	HM 50 T2 4kW (A9:4)	2880	7,63	4	18.500	68	48	2
26151698__P	HM 50 T2 4kW (A9:8)	2880	7,63	4	17.400	65	50	2
26161694__P	HM 56 T2 1,5kW (A9:4)	2865	3,14	1,50	12.200	72	56	2
26162694__P	HM 56 T2 2,2kW (A9:4)	2840	4,58	2,20	14.700	67	58	2
26162698__P	HM 56 T2 2,2kW (A9:8)	2840	4,58	2,20	12.600	73	62	2
26160694__P	HM 56 T2 3kW (A9:4)	2880	5,92	3	19.900	65	66	2
26160698__P	HM 56 T2 3kW (A9:8)	2880	5,92	3	15.500	68	70	2
26159694__P	HM 56 T2 4kW (A9:4)	2880	7,63	4	22.500	66	71	2
26159698__P	HM 56 T2 4kW (A9:8)	2880	7,63	4	19.700	68	71	2
26158695__P	HM 56 T2 5,5kW (A9:5)	2910	10,6	5,50	24.500	72	83	2
26158690__P	HM 56 T2 5,5kW (A9:10)	2910	10,6	5,50	20.700	72	87	2
26157690__P	HM 56 T2 7,5kW (A9:10)	2910	14,1	7,50	23.500	71	95	2
26167694__P	HM 63 T2 1,5kW (A9:4)	2865	3,14	1,50	14.500	71	61	2
26168694__P	HM 63 T2 2,2kW (A9:4)	2840	4,58	2,20	17.900	67	63	2
26169694__P	HM 63 T2 3kW (A9:4)	2880	5,92	3	22.700	66	75	2
26169698__P	HM 63 T2 3kW (A9:8)	2880	5,92	3	15.100	72	75	2

Code	Model	R.P.M.	Rated I. (A) 400V	Rated power kW	Max. Airflow m3/h	Sound db (A)*	Weight	Connect. diagram
26170694__P	HM 63 T2 4kW (A9:4)	2880	7,63	4	25.400	66	76	2
26170698__P	HM 63 T2 4kW (A9:8)	2880	7,63	4	19.200	69	80	2
26171690__P	HM 63 T2 5,5kW (A9:10)	2910	10,6	5,50	21.200	74	92	2
26166695__P	HM 63 T2 7,5kW (A9:5)	2910	14,1	7,50	28.700	73	96	2
26166690__P	HM 63 T2 7,5kW (A9:10)	2910	14,1	7,50	26.900	72	100	2
26165695__P	HM 63 T2 11kW (A9:5)	2940	20,8	11	33.500	73	160	2
26165690__P	HM 63 T2 11kW (A9:10)	2940	20,8	11	31.100	74	160	2
26164690__P	HM 63 T2 15kW (A9:10)	2935	27,4	15	36.500	77	173	2

### Three-phase motor / 4 poles

Code	Model	R.P.M.	Rated I. (A) 400V	Rated power kW	Max. Airflow m3/h	Sound db (A)*	Weight	Connect. diagram
26135606__P	HM 35 T4 0,12kW (A0:6)	1400	0,46	0,12	3.100	42	12	2
26140606__P	HM 40 T4 0,25kW (A0:6)	1400	0,79	0,25	4.690	48	19	2
26147606__P	HM 45 T4 0,55kW (A0:6)	1400	1,49	0,55	7.260	50	21	2
26150606__P	HM 50 T4 0,55kW (A0:6)	1400	1,49	0,55	9.320	52	29	2
26157656__P	HM 56 T4 0,37kW (A5:6)	1400	1,07	0,37	7.230	58	55	2
26158626__P	HM 56 T4 0,55kW (A2:6)	1400	1,49	0,55	8.290	56	57	2
26158629__P	HM 56 T4 0,55kW (A2:9)	1400	1,49	0,55	6.590	56	60	2
26158656__P	HM 56 T4 0,55kW (A5:6)	1400	1,49	0,55	8.680	58	57	2
26159626__P	HM 56 T4 0,75kW (A2:6)	1410	1,63	0,75	10.500	54	58	2
26159629__P	HM 56 T4 0,75kW (A2:9)	1410	1,63	0,75	8.170	56	59	2
26159656__P	HM 56 T4 0,75kW (A5:6)	1410	1,63	0,75	10.810	57	58	2
26160626__P	HM 56 T4 1,1kW (A2:6)	1450	2,49	1,10	12.900	54	59	2
26160629__P	HM 56 T4 1,1kW (A2:9)	1450	2,49	1,10	11.700	57	62	2
26160656__P	HM 56 T4 1,1kW (A5:6)	1450	2,49	1,10	12.520	56	59	2
26161626__P	HM 56 T4 1,5kW (A2:6)	1440	3,26	1,50	13.900	56	62	2
26161629__P	HM 56 T4 1,5kW (A2:9)	1440	3,26	1,50	13.600	57	64	2
26161656__P	HM 56 T4 1,5kW (A5:6)	1440	3,26	1,50	13.560	57	61	2
26164626__P	HM 63 T4 0,55kW (A2:6)	1400	1,49	0,55	9.020	54	64	2
26165626__P	HM 63 T4 0,75kW (A2:6)	1410	1,63	0,75	11.400	57	65	2
26165629__P	HM 63 T4 0,75kW (A2:9)	1410	1,63	0,75	9.120	59	69	2
26165656__P	HM 63 T4 0,75kW (A5:6)	1410	1,63	0,75	12.020	60	65	2
26166626__P	HM 63 T4 1,1kW (A2:6)	1450	2,49	1,10	15.000	56	69	2
26166629__P	HM 63 T4 1,1kW (A2:9)	1450	2,49	1,10	11.700	59	73	2
26166656__P	HM 63 T4 1,1kW (A5:6)	1450	2,49	1,10	14.740	61	69	2
26167626__P	HM 63 T4 1,5kW (A2:6)	1440	3,26	1,50	18.300	56	71	2

Code	Model	R.P.M.	Rated I. (A) 400V	Rated power kW	Max. Airflow m3/h	Sound db (A)*	Weight	Connect. diagram
26167629__P	HM 63 T4 1,5kW (A2:9)	1440	3,26	1,50	15.700	59	75	2
26167656__P	HM 63 T4 1,5kW (A5:6)	1440	3,26	1,50	16.610	57	71	2
26168626__P	HM 63 T4 2,2kW (A2:6)	1435	4,64	2,20	20.100	57	72	2
26168629__P	HM 63 T4 2,2kW (A2:9)	1435	4,64	2,20	20.300	60	76	2
26168656__P	HM 63 T4 2,2kW (A5:6)	1435	4,64	2,20	18.630	58	72	2
26169629__P	HM 63 T4 3kW (A2:9)	1420	6,17	3	21.800	60	77	2
26172626__P	HM 71 T4 0,75KW (A2:6)	1410	1,63	0,75	12.000	63	77	2
26172656__P	HM 71 T4 0,75kW (A5:6)	1410	1,63	0,75	13.630	65	78	2
26173626__P	HM 71 T4 1,1kW (A2:6)	1450	2,49	1,10	15.500	62	80	2
26173629__P	HM 71 T4 1,1kW (A2:9)	1450	2,49	1,10	12.100	65	82	2
26173656__P	HM 71 T4 1,1kW (A5:6)	1450	2,49	1,10	16.800	64	80	2
26174626__P	HM 71 T4 1,5kW (A2:6)	1440	3,26	1,50	20.800	60	82	2
26174629__P	HM 71 T4 1,5kW (A2:9)	1440	3,26	1,50	15.700	64	84	2
26174656__P	HM 71 T4 1,5kW (A5:6)	1440	3,26	1,50	19.960	63	82	2
26175626__P	HM 71 T4 2,2kW (A2:6)	1435	4,64	2,20	25.300	59	87	2
26175629__P	HM 71 T4 2,2kW (A2:9)	1435	4,64	2,20	21.600	63	88	2
26175656__P	HM 71 T4 2,2kW (A5:6)	1435	4,64	2,20	23.200	61	87	2
26176626__P	HM 71 T4 3kW (A2:6)	1420	6,17	3	27.900	60	89	2
26176629__P	HM 71 T4 3kW (A2:9)	1420	6,17	3	25.300	63	91	2
26176656__P	HM 71 T4 3kW (A5:6)	1420	6,17	3	25.160	63	89	2
26181626__P	HM 80 T4 1,1KW (A2:6)	1450	2,49	1,10	15.400	63	80	2
26182626__P	HM 80 T4 1,5KW (A2:6)	1440	3,26	1,50	20.300	63	84	2
26182629__P	HM 80 T4 1,5KW (A2:9)	1440	3,26	1,50	16.200	71	85	2
26183626__P	HM 80 T4 2,2kW (A2:6)	1435	4,64	2,20	27.900	63	93	2
26183629__P	HM 80 T4 2,2kW (A2:9)	1435	4,64	2,20	21.200	69	96	2
26184626__P	HM 80 T4 3kW (A2:6)	1420	6,17	3	32.500	62	97	2
26184629__P	HM 80 T4 3kW (A2:9)	1420	6,17	3	26.400	67	100	2
26184656__P	HM 80 T4 3kW (A5:6)	1420	6,17	3	31.090	63	97	2
26185626__P	HM 80 T4 4kW (A2:6)	1440	8,32	4	36.100	62	108	2
26185629__P	HM 80 T4 4kW (A2:9)	1440	8,32	4	31.900	66	110	2
26185656__P	HM 80 T4 4kW (A5:6)	1440	8,32	4	34.000	64	108	2
26186626__P	HM 80 T4 5,5kW (A2:6)	1460	10,5	5,50	39.000	62	110	2
26186629__P	HM 80 T4 5,5kW (A2:9)	1460	10,5	5,50	38.200	65	113	2
26193663__P	HM 90 T4 3kW (A6:3)	1420	6,17	3	30.700	61	109	2
26194663__P	HM 90 T4 4kW (A6:3)	1440	8,32	4	37.700	64	120	2
26195663__P	HM 90 T4 5,5kW (A6:3)	1460	10,5	5,50	41.400	67	124	2
26195666__P	HM 90 T4 5,5kW (A6:6)	1460	10,5	5,50	33.400	71	128	2
26196663__P	HM 90 T4 7,5kW (A6:3)	1455	14,1	7,50	45.700	68	136	2
26196666__P	HM 90 T4 7,5kW (A6:6)	1455	14,1	7,50	40.800	72	141	2

Code	Model	R.P.M.	Rated I. (A) 400V	Rated power kW	Max. Airflow m3/h	Sound db (A)*	Weight	Connect. diagram
26197663__P	HM 90 T4 11kW (A6:3)	1455	21,2	11	49.700	70	177	2
26197666__P	HM 90 T4 11kW (A6:6)	1455	21,2	11	48.700	69	181	2
26198666__P	HM 90 T4 15kW (A6:6)	1465	29,8	15	56.500	69	201	2
26114663__P	HM 100 T4 5,5kW (A6:3)	1460	10,5	5,50	48.700	68	138	2
26115663__P	HM 100 T4 7,5kW (A6:3)	1455	14,1	7,50	55.500	68	152	2
26115666__P	HM 100 T4 7,5kW (A6:6)	1455	14,1	7,50	44.200	76	155	2
26116663__P	HM 100 T4 11kW (A6:3)	1455	21,2	11	63.000	69	192	2
26116666__P	HM 100 T4 11kW (A6:6)	1455	21,2	11	56.200	76	197	2
26117663__P	HM 100 T4 15kW (A6:3)	1465	29,8	15	67.100	71	218	2
26117666__P	HM 100 T4 15kW (A6:6)	1465	29,8	15	63.500	75	221	2
26118666__P	HM 100 T4 18,5kW (A6:6)	1470	35,6	18,50	71.200	73	261	2
26119666__P	HM 100 T4 22kW (A6:6)	1465	40,1	22	78.300	73	270	2
26123663__P	HM 112 T4 5,5kW (A6:3)	1460	10,5	5,50	52.700	73	165	2
26124663__P	HM 112 T4 7,5kW (A6:3)	1455	14,1	7,50	63.400	74	175	2
26125663__P	HM 112 T4 11kW (A6:3)	1455	21,2	11	72.600	73	212	2
26125666__P	HM 112 T4 11kW (A6:6)	1455	21,2	11	55.700	78	218	2
26126663__P	HM 112 T4 15kW (A6:3)	1465	29,8	15	83.600	73	233	2
26126666__P	HM 112 T4 15kW (A6:6)	1465	29,8	15	72.700	77	238	2
26127663__P	HM 112 T4 18,5kW (A6:3)	1470	35,6	18,50	87.300	74	270	2
26127666__P	HM 112 T4 18,5kW (A6:6)	1470	35,6	18,50	77.900	77	275	2
26128663__P	HM 112 T4 22kW (A6:3)	1465	40,1	22	89.800	74	271	2
26128666__P	HM 112 T4 22kW (A6:6)	1465	40,1	22	88.400	75	276	2
26129666__P	HM 112 T4 30kW (A6:6)	1475	56,3	30	104.000	76	322	2
27106674__P	HM 125 T4 11kW (A7:4)	1455	21,2	11	71.400	83	252	2
27107674__P	HM 125 T4 15kW (A7:4)	1465	29,8	15	85.800	80	275	2
27107678__P	HM 125 T4 15kW (A7:8)	1465	29,8	15	66.300	89	280	2
27108674__P	HM 125 T4 18,5kW (A7:4)	1470	35,6	18,50	99.200	76	320	2
27108678__P	HM 125 T4 18,5kW (A7:8)	1470	35,6	18,50	73.800	87	323	2
27109674__P	HM 125 T4 22kW (A7:4)	1465	40,1	22	105.000	75	317	2
27109678__P	HM 125 T4 22kW (A7:8)	1465	40,1	22	81.800	86	324	2
27110674__P	HM 125 T4 30kW (A7:4)	1475	56,3	30	117.000	75	368	2
27110678__P	HM 125 T4 30kW (A7:8)	1475	56,3	30	99.200	84	375	2
27111674__P	HM 125 T4 37kW (A7:4)	1470	69,2	37	127.000	76	453	2
27112678__P	HM 125 T4 37kW (A7:8)	1470	69,2	37	114.000	80	500	2
27112678__P	HM 125 T4 45kW (A7:8)	1475	80,7	45	129.000	79	500	2

### Three-phase motor / 6 poles

Code	Model	R.P.M.	Rated I. (A) 400V	Rated power kW	Max. Airflow m3/h	Sound db (A)*	Weight	Connect. diagram
26144606__P	HM 40 T6 0,12kW (A0:6)	850	0,62	0,12	2.760	36	20	2
26149606__P	HM 45 T6 0,13kW (A0:6)	920	0,41	0,13	4.710	41	23	2
26152606__P	HM 50 T6 0,13kW (A0:6)	920	0,41	0,13	6.040	43	27	2
26156656__P	HM 56 T6 0,25kW (A5:6)	900	0,92	0,25	7.700	47	55	2
26157656__P	HM 56 T6 0,37kW (A5:6)	900	1,27	0,37	8.770	47	55	2
26154626__P	HM 56 T6 0,55kW (A2:6)	900	1,8	0,55	9.000	45	55	2
26154629__P	HM 56 T6 0,55kW (A2:9)	900	1,8	0,55	9.510	47	59	2
26163656__P	HM 63 T6 0,37kW (A5:6)	900	1,27	0,37	10.760	49	63	2
26164626__P	HM 63 T6 0,55kW (A2:6)	900	1,8	0,55	13.000	45	65	2
26164629__P	HM 63 T6 0,55kW (A2:9)	900	1,8	0,55	11.900	49	68	2
26164656__P	HM 63 T6 0,55kW (A5:6)	900	1,8	0,55	12.050	49	64	2
26165629__P	HM 63 T6 0,75kW (A2:9)	925	1,95	0,75	14.100	50	69	2
26171626__P	HM 71 T6 0,55kW (A2:6)	900	1,8	0,55	15.500	49	73	2
26171629__P	HM 71 T6 0,55kW (A2:9)	900	1,8	0,55	12.700	53	75	2
26172626__P	HM 71 T6 0,75kW (A2:6)	925	1,95	0,75	18.100	51	73	2
26172629__P	HM 71 T6 0,75kW (A2:9)	925	1,95	0,75	16.400	53	75	2
26172656__P	HM 71 T6 0,75kW (A5:6)	925	1,95	0,75	16.250	53	74	2
26173629__P	HM 71 T6 1,1kW (A2:9)	925	2,78	1,10	19.600	52	78	2
26180626__P	HM 80 T6 0,75kW (A2:6)	925	1,95	0,75	19.500	53	87	2
26180629__P	HM 80 T6 0,75kW (A2:9)	925	1,95	0,75	17.100	58	89	2
26180656__P	HM 80 T6 0,75kW (A5:6)	925	1,95	0,75	18.300	59	87	2
26181626__P	HM 80 T6 1,1kW (A2:6)	925	2,78	1,10	23.400	52	89	2
26181629__P	HM 80 T6 1,1kW (A2:9)	925	2,78	1,10	20.700	56	92	2
26181656__P	HM 80 T6 1,1kW (A5:6)	925	2,78	1,10	20.550	55	89	2
26182626__P	HM 80 T6 1,5kW (A2:6)	940	3,71	1,50	25.300	53	91	2
26182629__P	HM 80 T6 1,5kW (A2:9)	940	3,71	1,50	24.800	55	93	2
26182656__P	HM 80 T6 1,5kW (A5:6)	940	3,71	1,50	22.970	55	90	2
26183629__P	HM 80 T6 2,2kW (A2:9)	965	5,94	2,20	27.100	55	94	2
26183656__P	HM 80 T6 2,2kW (A5:6)	965	5,94	2,20	25.190	56	92	2
26191663__P	HM 90 T6 1,5kW (A6:3)	940	3,71	1,50	26.800	52	100	2
26191666__P	HM 90 T6 1,5kW (A6:6)	940	3,71	1,50	23.500	62	103	2
26192663__P	HM 90 T6 2,2kW (A6:3)	965	5,94	2,20	31.100	59	105	2
26192666__P	HM 90 T6 2,2kW (A6:6)	965	5,94	2,20	28.100	63	108	2
26193663__P	HM 90 T6 3kW (A6:3)	960	7,3	3	32.200	61	122	2
26193666__P	HM 90 T6 3kW (A6:6)	960	7,3	3	33.400	60	126	2
26194666__P	HM 90 T6 4kW (A6:6)	960	9,46	4	36.600	60	132	2
26110663__P	HM 100 T6 1,5kW (A6:3)	940	3,71	1,50	31.500	59	118	2
26111663__P	HM 100 T6 2,2kW (A6:3)	965	5,94	2,20	37.900	58	120	2
26111666__P	HM 100 T6 2,2kW (A6:6)	965	5,94	2,20	31.300	66	126	2

Code	Model	R.P.M.	Rated I. (A) 400V	Rated power kW	Max. Airflow m3/h	Sound db (A)*	Weight	Connect. diagram
26112663__P	HM 100 T6 3kW (A6:3)	960	7,3	3	40.800	60	137	2
26112666__P	HM 100 T6 3kW (A6:6)	960	7,3	3	36.400	66	144	2
26113663__P	HM 100 T6 4kW (A6:3)	960	9,46	4	43.500	62	147	2
26113666__P	HM 100 T6 4kW (A6:6)	960	9,46	4	41.100	65	150	2
26114666__P	HM 100 T6 5,5kW (A6:6)	960	12,8	5,50	48.700	63	154	2
26115666__P	HM 100 T6 7,5kW (A6:6)	965	15,2	7,50	50.700	65	180	2
26120663__P	HM 112 T6 2,2kW (A6:3)	965	5,94	2,20	41.000	63	149	2
26120666__P	HM 112 T6 2,2kW (A6:6)	965	5,94	2,20	32.500	69	150	2
26121663__P	HM 112 T6 3kW (A6:3)	960	7,3	3	49.400	64	165	2
26121666__P	HM 112 T6 3kW (A6:6)	960	7,3	3	39.800	68	168	2
26122663__P	HM 112 T6 4kW (A6:3)	960	9,46	4	54.200	64	171	2
26122666__P	HM 112 T6 4kW (A6:6)	960	9,46	4	47.100	68	178	2
26123663__P	HM 112 T6 5,5kW (A6:3)	960	12,8	5,50	58.200	64	174	2
26123666__P	HM 112 T6 5,5kW (A6:6)	960	12,8	5,50	53.900	66	181	2
26124666__P	HM 112 T6 7,5kW (A6:6)	965	15,2	7,50	64.100	66	233	2
26125666__P	HM 112 T6 11kW (A6:6)	965	22,6	11	67.300	68	248	2
27102674__P	HM 125 T6 3kW (A7:4)	960	7,3	3	46.300	73	200	2
27103674__P	HM 125 T6 4kW (A7:4)	960	9,46	4	55.600	70	210	2
27104674__P	HM 125 T6 5,5kW (A7:4)	960	12,8	5,50	64.300	66	215	2
27104678__P	HM 125 T6 5,5kW (A7:8)	960	12,8	5,50	47.800	78	219	2
27105674__P	HM 125 T6 7,5kW (A7:4)	965	15,2	7,50	75.700	65	268	2
27105678__P	HM 125 T6 7,5kW (A7:8)	965	15,2	7,50	58.600	75	277	2
27106674__P	HM 125 T6 11kW (A7:4)	965	22,6	11	82.400	66	285	2
27106678__P	HM 125 T6 11kW (A7:8)	965	22,6	11	78.900	69	294	2
27107678__P	HM 125 T6 15kW (A7:8)	970	27,7	15	93.300	68	334	2

## 2 SPEED MOTOR / 2/4 poles

Code	Model	R.P.M.	Rated I. (A) 400V	Rated power kW	Max. Airflow m3/h	Sound db (A)*	Weight	Connect. diagram
26144694__PV	HM 45 T2/T4 0,75/0,18kW (A9:4)	2780	2/0,37	0,75	7.860	-	28	3
26143694__PV	HM 45 T2/T4 1,1/0,25kW (A9:4)	2790	2,5/0,45	1,10	9.160	-	30	3
26143698__PV	HM 45 T2/T4 1,1/0,25kW (A9:8)	2790	2,5/0,45	1,10	7.850	-	25	3
26146694__PV	HM 45 T2/T4 1,5/0,37kW (A9:4)	2810	3,6/0,6	1,50	11.000	-	34	3
26146698__PV	HM 45 T2/T4 1,5/0,37kW (A9:8)	2810	3,6/0,6	1,50	9.460	-	35	3
26148694__PV	HM 45 T2/T4 2,2/0,55kW (A9:4)	2840	5/9,5	2,20	13.400	-	36	3
26148698__PV	HM 45 T2/T4 2,2/0,55kW (A9:8)	2840	5/9,5	2,20	11.600	-	37	3
26149694__PV	HM 45 T2/T4 3/0,75kW (A9:4)	2850	6,4/1,1	3	14.200	-	44	3



Code	Model	R.P.M.	Rated I. (A) 400V	Rated power kW	Max. Airflow m3/h	Sound db (A)*	Weight	Connect. diagram
26149698__PV	HM 45 T2/T4 3/0,75kW (A9:8)	2850	6,4/1,1	3	13.100	-	45	3
26153694__PV	HM 50 T2/T4 1,1/0,25kW (A9:4)	2790	2,5/0,45	1,10	9.800	-	34	3
26154698__PV	HM 50 T2/T4 1,5/0,37kW (A9:8)	2810	3,6/0,6	1,50	10.000	-	33	3
26154694__PV	HM 50 T2/T4 1,5/0,37kW (A9:4)	2810	3,6/0,6	1,50	11.900	-	38	3
26155694__PV	HM 50 T2/T4 2,2/0,55kW (A9:4)	2840	5/9,5	2,20	15.800	-	40	3
26155698__PV	HM 50 T2/T4 2,2/0,55kW (A9:8)	2840	5/9,5	2,20	12.400	-	42	3
26152694__PV	HM 50 T2/T4 3/0,75kW (A9:4)	2850	6,4/1,1	3	17.600	-	48	3
26152698__PV	HM 50 T2/T4 3/0,75kW (A9:8)	2850	6,4/1,1	3	15.300	-	43	3
26151694__PV	HM 50 T2/T4 4,5/0,9kW (A9:4)	2850	9,5/1,4	4,50	18.500	-	53	3
26151698__PV	HM 50 T2/T4 4,5/0,9kW (A9:8)	2850	9,5/1,4	4,50	17.400	-	55	3
26161694__PV	HM 56 T2/T4 1,5/0,37kW (A9:4)	2810	3,6/0,6	1,50	12.200	-	61	3
26162694__PV	HM 56 T2/T4 2,2/0,55kW (A9:4)	2840	5/9,5	2,20	14.700	-	63	3
26162698__PV	HM 56 T2/T4 2,2/0,55kW (A9:8)	2840	5/9,5	2,20	12.600	-	67	3
26160694__PV	HM 56 T2/T4 3/0,75kW (A9:4)	2850	6,4/1,1	3	19.900	-	71	3
26160698__PV	HM 56 T2/T4 3/0,75kW (A9:8)	2850	6,4/1,1	3	15.500	-	75	3
26159694__PV	HM 56 T2/T4 4,5/0,9kW (A9:4)	2850	9,5/1,4	4,50	22.500	-	76	3
26159698__PV	HM 56 T2/T4 4,5/0,9kW (A9:8)	2850	9,5/1,4	4,50	19.700	-	71	3
26158695__PV	HM 56 T2/T4 5,5/1,5kW (A9:5)	2890	22/2	5,50	24.500	-	88	3
26158690__PV	HM 56 T2/T4 5,5/1,5kW (A9:10)	2890	22/2	5,50	20.700	-	92	3
26157690__PV	HM 56 T2/T4 8/1,85kW (A9:10)	2940	15,5/2,5	8	23.500	-	100	3
26167694__PV	HM 63 T2/T4 1,5/0,37kW (A9:4)	2810	3,6/0,6	1,50	14.500	-	66	3
26168694__PV	HM 63 T2/T4 2,2/0,55kW (A9:4)	2840	5/9,5	2,20	17.900	-	68	3
26169694__PV	HM 63 T2/T4 3/0,75kW (A9:4)	2850	6,4/1,1	3	22.700	-	75	3
26169698__PV	HM 63 T2/T4 3/0,75kW (A9:8)	2850	6,4/1,1	3	15.100	-	80	3
26170694__PV	HM 63 T2/T4 4,5/0,9kW (A9:4)	2850	9,5/1,4	4,50	25.400	-	81	3
26170698__PV	HM 63 T2/T4 4,5/0,9kW (A9:8)	2850	9,5/1,4	4,50	19.200	-	85	3
26171690__PV	HM 63 T2/T4 5,5/1,5kW (A9:10)	2890	22/2	5,50	21.200	-	97	3
26166695__PV	HM 63 T2/T4 8/1,85kW (A9:5)	2940	15,5/2,5	8	28.700	-	101	3
26166690__PV	HM 63 T2/T4 8/1,85kW (A9:10)	2940	15,5/2,5	8	26.900	-	105	3
26165695__PV	HM 63 T2/T4 11/2,8kW (A9:5)	2940	24/0,8	11	34.800	-	160	3
26165690__PV	HM 63 T2/T4 11/3kW (A9:10)	2930	24/0,8	11	31.100	-	165	3
26164690__PV	HM 63 T2/T4 15/4kW (A9:10)	2950	28/6	15	36.500	-	178	3

## 2 SPEED MOTOR / 4/6 poles

Code	Model	R.P.M.	Rated I. (A) 400V	Rated power kW	Max. Airflow m3/h	Sound db (A)*	Weight	Connect. diagram
26135606__PV6	HM 45 T4/T6 0,55/0,18kW (A0:6)	1400	1,71/0,5	0,55	7.260	-	21	4

Code	Model	R.P.M.	Rated I. (A) 400V	Rated power kW	Max. Airflow m3/h	Sound db (A)*	Weight	Connect. diagram
26140606__PV6	HM 50 T4/T6 0,55/0,18kW (A0:6)	1400	1,71/0,5	0,55	9.320	-	29	4
26147606__PV6	HM 56 T4/T6 0,37/0,13kW (A5:6)	1400	1,15/0,7	0,37	7.230	-	55	4
26150606__PV6	HM 56 T4/T6 0,55/0,18kW (A2:6)	1400	1,71/0,5	0,55	8.290	-	57	4
26157656__PV6	HM 56 T4/T6 0,55/0,18kW (A2:9)	1400	1,71/0,5	0,55	6.590	-	60	4
26158626__PV6	HM 56 T4/T6 0,55/0,18kW (A5:6)	1400	1,71/0,5	0,55	8.680	-	57	4
26158629__PV6	HM 56 T4/T6 0,75/0,25kW (A2:6)	1410	1,8/0,8	0,75	10.500	-	58	4
26158656__PV6	HM 56 T4/T6 0,75/0,25kW (A2:9)	1410	1,8/0,8	0,75	8.170	-	59	4
26159626__PV6	HM 56 T4/T6 0,75/0,25kW (A5:6)	1410	1,8/0,8	0,75	10.810	-	58	4
26159629__PV6	HM 56 T4/T6 1,1/0,37kW (A2:6)	1450	2,8/1,2	1,10	12.900	-	59	4
26159656__PV6	HM 56 T4/T6 1,1/0,37kW (A2:9)	1450	2,8/1,2	1,10	11.700	-	62	4
26160626__PV6	HM 56 T4/T6 1,1/0,37kW (A5:6)	1450	2,8/1,2	1,10	12.520	-	59	4
26160629__PV6	HM 56 T4/T6 1,5/0,5kW (A2:6)	1440	4/2,2	1,50	13.900	-	62	4
26160656__PV6	HM 56 T4/T6 1,5/0,5kW (A2:9)	1440	4/2,2	1,50	13.600	-	64	4
26161626__PV6	HM 56 T4/T6 1,5/0,5kW (A5:6)	1440	4/2,2	1,50	13.560	-	61	4
26161629__PV6	HM 63 T4/T6 0,55/0,18kW (A2:6)	1400	1,71/0,5	0,55	9.020	-	64	4
26161656__PV6	HM 63 T4/T6 0,75/0,25kW (A2:6)	1410	1,8/0,8	0,75	11.400	-	65	4
26164626__PV6	HM 63 T4/T6 0,75/0,25kW (A2:9)	1410	1,8/0,8	0,75	9.120	-	69	4
26165626__PV6	HM 63 T4/T6 0,75/0,25kW (A5:6)	1410	1,8/0,8	0,75	12.020	-	65	4
26165629__PV6	HM 63 T4/T6 1,1/0,37kW (A2:6)	1450	2,8/1,2	1,10	15.000	-	69	4
26165656__PV6	HM 63 T4/T6 1,1/0,37kW (A2:9)	1450	2,8/1,2	1,10	11.700	-	73	4
26166626__PV6	HM 63 T4/T6 1,1/0,37kW (A5:6)	1450	2,8/1,2	1,10	14.740	-	69	4
26166629__PV6	HM 63 T4/T6 1,5/0,5kW (A2:6)	1440	4/2,2	1,50	18.300	-	71	4
26166656__PV6	HM 63 T4/T6 1,5/0,5kW (A2:9)	1440	4/2,2	1,50	15.700	-	75	4
26167626__PV6	HM 63 T4/T6 1,5/0,5kW (A5:6)	1440	4/2,2	1,50	16.610	-	71	4
26167629__PV6	HM 63 T4/T6 2,2/0,6kW (A2:6)	1435	5/1,8	2,20	20.100	-	72	4
26167656__PV6	HM 63 T4/T6 2,2/0,6kW (A2:9)	1435	5/1,8	2,20	20.300	-	76	4
26168626__PV6	HM 63 T4/T6 2,2/0,6kW (A5:6)	1435	5/1,8	2,20	18.630	-	72	4
26168629__PV6	HM 63 T4/T6 3/0,9kW (A2:9)	1420	7/3	3	21.800	-	77	4
26168656__PV6	HM 71 T4/T6 0,75/0,25kW (A2:6)	1410	1,8/0,8	0,75	12.000	-	77	4
26169629__PV6	HM 71 T4/T6 0,75/0,25kW (A5:6)	1410	1,8/0,8	0,75	13.630	-	78	4
26172626__PV6	HM 71 T4/T6 1,1/0,37kW (A2:6)	1450	2,8/1,2	1,10	15.500	-	80	4
26172656__PV6	HM 71 T4/T6 1,1/0,37kW (A2:9)	1450	2,8/1,2	1,10	12.100	-	82	4
26173626__PV6	HM 71 T4/T6 1,1/0,37kW (A5:6)	1450	2,8/1,2	1,10	16.800	-	80	4
26173629__PV6	HM 71 T4/T6 1,5/0,5kW (A2:6)	1440	4/2,2	1,50	20.800	-	82	4
26173656__PV6	HM 71 T4/T6 1,5/0,5kW (A2:9)	1440	4/2,2	1,50	15.700	-	84	4
26174626__PV6	HM 71 T4/T6 1,5/0,5kW (A5:6)	1440	4/2,2	1,50	19.960	-	82	4
26174629__PV6	HM 71 T4/T6 2,2/0,6kW (A2:6)	1435	5/1,8	2,20	25.300	-	87	4
26174656__PV6	HM 71 T4/T6 2,2/0,6kW (A2:9)	1435	5/1,8	2,20	21.600	-	88	4
26175626__PV6	HM 71 T4/T6 2,2/0,6kW (A5:6)	1435	5/1,8	2,20	23.200	-	87	4

Code	Model	R.P.M.	Rated I. (A) 400V	Rated power kW	Max. Airflow m3/h	Sound db (A)*	Weight	Connect. diagram
26175629__PV6	HM 71 T4/T6 3/0,9kW (A2:6)	1420	7/3	3	27.900	-	89	4
26175656__PV6	HM 71 T4/T6 3/0,9kW (A2:9)	1420	7/3	3	25.300	-	91	4
26176626__PV6	HM 71 T4/T6 3/0,9kW (A5:6)	1420	7/3	3	25.160	-	89	4
26176629__PV6	HM 80 T4/T6 1,1/0,37kW (A2:6)	1450	2,8/1,2	1,10	15.400	-	80	4
26176656__PV6	HM 80 T4/T6 1,5/0,5kW (A2:6)	1440	4/2,2	1,50	20.300	-	84	4
26181626__PV6	HM 80 T4/T6 1,5/0,5kW (A2:9)	1440	4/2,2	1,50	16.200	-	85	4
26182626__PV6	HM 80 T4/T6 2,2/0,6kW (A2:6)	1435	5/1,8	2,20	27.900	-	93	4
26182629__PV6	HM 80 T4/T6 2,2/0,6kW (A2:9)	1435	5/1,8	2,20	21.200	-	96	4
26183626__PV6	HM 80 T4/T6 3/0,9kW (A2:6)	1420	7/3	3	32.500	-	97	4
26183629__PV6	HM 80 T4/T6 3/0,9kW (A2:9)	1420	7/3	3	26.400	-	100	4
26184626__PV6	HM 80 T4/T6 3/0,9kW (A5:6)	1420	7/3	3	31.090	-	97	4
26184629__PV6	HM 80 T4/T6 4/1,1kW (A2:6)	1440	9/3,3	4	36.100	-	108	4
26184656__PV6	HM 80 T4/T6 4/1,1kW (A2:9)	1440	9/3,3	4	31.900	-	110	4
26185626__PV6	HM 80 T4/T6 4/1,1kW (A5:6)	1440	9/3,3	4	34.000	-	108	4
26185629__PV6	HM 80 T4/T6 5,5/1,85kW (A2:6)	1460	12/4,7	5,50	39.000	-	110	4
26185656__PV6	HM 80 T4/T6 5,5/1,85kW (A2:9)	1460	12/4,7	5,50	38.200	-	113	4
26197666__PV6	HM 90 T4/T6 3/0,9kW (A6:3)	1420	7/3	3	30.700	-	109	4
26198666__PV6	HM 90 T4/T6 4/1,1kW (A6:3)	1440	9/3,3	4	37.700	-	120	4
26193663__PV6	HM 90 T4/T6 5,5/1,85kW (A6:3)	1460	12/4,7	5,50	41.400	-	124	4
26194663__PV6	HM 90 T4/T6 5,5/1,85kW (A6:6)	1460	12/4,7	5,50	33.400	-	128	4
26195663__PV6	HM 90 T4/T6 7,5/2,2kW (A6:3)	1455	15,5/6	7,50	45.700	-	136	4
26195666__PV6	HM 90 T4/T6 7,5/2,2kW (A6:6)	1455	15,5/6	7,50	40.800	-	141	4
26186626__PV6	HM 90 T4/T6 11/3,6kW (A6:3)	1455	23/10	11	49.700	-	177	4
26186629__PV6	HM 90 T4/T6 11/3,6kW (A6:6)	1455	23/10	11	48.700	-	181	4
26197663__PV6	HM 90 T4/T6 15/4,4kW (A6:6)	1465	28/11	15	56.500	-	201	4
26114663__PV6	HM 100 T4/T6 5,5/1,85kW (A6:3)	1460	12/4,7	5,50	48.700	-	138	4
26115663__PV6	HM 100 T4/T6 7,5/2,2kW (A6:3)	1455	15,5/6	7,50	55.500	-	152	4
26115666__PV6	HM 100 T4/T6 7,5/2,2kW (A6:6)	1455	15,5/6	7,50	44.200	-	155	4
26116663__PV6	HM 100 T4/T6 11/3,6kW (A6:3)	1455	23/10	11	63.000	-	192	4
26116666__PV6	HM 100 T4/T6 11/3,6kW (A6:6)	1455	23/10	11	56.200	-	197	4
26117663__PV6	HM 100 T4/T6 15/4,4kW (A6:3)	1465	28/11	15	67.100	-	218	4
26117666__PV6	HM 100 T4/T6 15/4,4kW (A6:6)	1465	28/11	15	63.500	-	221	4
26118666__PV6	HM 100 T4/T6 18,5/6kW (A6:6)	1470	36/14	18,50	71.200	-	261	4
26119666__PV6	HM 100 T4/T6 22/7,5kW (A6:6)	1465	42/16	22	78.300	-	270	4
26123663__PV6	HM 112 T4/T6 5,5/1,85kW (A6:3)	1460	12/4,7	5,50	52.700	-	165	4
26124663__PV6	HM 112 T4/T6 7,5/2,2kW (A6:3)	1455	15,5/6	7,50	63.400	-	175	4
26125663__PV6	HM 112 T4/T6 11/3,6kW (A6:3)	1455	23/10	11	72.600	-	212	4
26125666__PV6	HM 112 T4/T6 11/3,6kW (A6:6)	1455	23/10	11	55.700	-	218	4
26126663__PV6	HM 112 T4/T6 15/4,4kW (A6:3)	1465	28/11	15	83.600	-	233	4

Code	Model	R.P.M.	Rated I. (A) 400V	Rated power kW	Max. Airflow m3/h	Sound db (A)*	Weight	Connect. diagram
26126666__PV6	HM 112 T4/T6 15/4,4kW (A6:6)	1465	28/11	15	72.700	-	238	4
26127663__PV6	HM 112 T4/T6 18,5/6kW (A6:3)	1470	36/14	18,50	87.300	-	270	4
26127666__PV6	HM 112 T4/T6 18,5/6kW (A6:6)	1470	36/14	18,50	77.900	-	275	4
26128663__PV6	HM 112 T4/T6 22/7,5kW (A6:3)	1465	42/16	22	89.800	-	271	4
26128666__PV6	HM 112 T4/T6 22/7,5kW (A6:6)	1465	42/16	22	88.400	-	276	4
27106674__PV6	HM 125 T4/T6 11/3,6kW (A7:4)	1455	23/10	11	71.400	-	252	4
27107674__PV6	HM 125 T4/T6 15/4,4kW (A7:4)	1465	28/11	15	85.800	-	275	4
27107678__PV6	HM 125 T4/T6 15/4,4kW (A7:8)	1465	28/11	15	66.300	-	280	4
27108674__PV6	HM 125 T4/T6 18,5/6kW (A7:4)	1470	36/14	18,50	99.200	-	320	4
27108678__PV6	HM 125 T4/T6 18,5/6kW (A7:8)	1470	36/14	18,50	73.800	-	323	4
27109674__PV6	HM 125 T4/T6 22/7,5kW (A7:4)	1465	42/16	22	105.000	-	317	4
27109678__PV6	HM 125 T4/T6 22/7,5kW (A7:8)	1465	42/16	22	81.800	-	324	4

## 2 SPEED MOTOR / 4/8 poles

Code	Model	R.P.M.	Rated I. (A) 400V	Rated power kW	Max. Airflow m3/h	Sound db (A)*	Weight	Connect. diagram
26145606__PV	HM 45 T4/T8 0,33/0,04kW (A0:6)	1360	1,5/0,5	0.33/0.04	6.610	-	21	3
26150606__PV	HM 50 T4/T8 0,55/0,09kW (A0:6)	1410	2/0,5	0.55/0.09	9.320	-	29	3
26157656__PV	HM 56 T4/T8 0,33/0,04kW (A5:6)	1360	1,5/0,5	0.33/0.04	7.230	42	56	3
26158626__PV	HM 56 T4/T8 0,55/0,09kW (A2:6)	1410	2/0,5	0.55/0.09	8.290	40	56	3
26158629__PV	HM 56 T4/T8 0,55/0,09kW (A2:9)	1410	2/0,5	0.55/0.09	6.590	40	56	3
26158656__PV	HM 56 T4/T8 0,55/0,09kW (A5:6)	1410	2/0,5	0.55/0.09	8.680	43	57	3
26159626__PV	HM 56 T4/T8 0,75/0,12kW (A2:6)	1430	1,8/1	0.75/0.12	10.500	38	62	3
26159629__PV	HM 56 T4/T8 0,75/0,12kW (A2:9)	1430	1,8/1	0.75/0.12	8.170	40	62	3
26159656__PV	HM 56 T4/T8 0,75/0,12kW (A5:6)	1430	1,8/1	0.75/0.12	10.810	42	58	3
26160626__PV	HM 56 T4/T8 1,1/0,18kW (A2:6)	1400	3/0,8	1.1/0.18	12.900	38	59	3
26160629__PV	HM 56 T4/T8 1,1/0,18kW (A2:9)	1400	3/0,8	1.1/0.18	11.700	41	62	3
26160656__PV	HM 56 T4/T8 1,1/0,18kW (A5:6)	1400	3/0,8	1.1/0.18	12.520	40	59	3
26161626__PV	HM 56 T4/T8 1,5/0,25kW (A2:6)	1380	4/1,5	1.5/0.25	13.900	40	62	3
26161629__PV	HM 56 T4/T8 1,5/0,25kW (A2:9)	1380	4/1,5	1.5/0.25	13.600	41	64	3
26161656__PV	HM 56 T4/T8 1,5/0,25kW (A5:6)	1380	4/1,5	1.5/0.25	13.560	42	61	3
26164626__PV	HM 63 T4/T8 0,55/0,09kW (A2:6)	1410	2/0,5	0.55/0.09	9.020	38	67	3
26165626__PV	HM 63 T4/T8 0,75/0,12kW (A2:6)	1430	1,8/1	0.75/0.12	11.400	41	68	3
26165629__PV	HM 63 T4/T8 0,75/0,12kW (A2:9)	1430	1,8/1	0.75/0.12	9.120	43	69	3
26165656__PV	HM 63 T4/T8 0,75/0,12kW (A5:6)	1430	1,8/1	0.75/0.12	12.020	45	65	3
26166626__PV	HM 63 T4/T8 1,1/0,18kW (A2:6)	1400	3/0,8	1.1/0.18	15.000	41	68	3
26166629__PV	HM 63 T4/T8 1,1/0,18kW (A2:9)	1400	3/0,8	1.1/0.18	13.500	43	70	3

Code	Model	R.P.M.	Rated I. (A) 400V	Rated power kW	Max. Airflow m3/h	Sound db (A)*	Weight	Connect. diagram
26166656__PV	HM 63 T4/T8 1,1/0,18kW (A5:6)	1400	3/0,8	1.1/0.18	14.740	46	69	3
26167626__PV	HM 63 T4/T8 1,5/0,25kW (A2:6)	1380	4/1,5	1.5/0.25	18.300	40	66	3
26167629__PV	HM 63 T4/T8 1,5/0,25kW (A2:9)	1380	4/1,5	1.5/0.25	15.700	44	69	3
26167656__PV	HM 63 T4/T8 1,5/0,25kW (A5:6)	1380	4/1,5	1.5/0.25	16.610	44	71	3
26168626__PV	HM 63 T4/T8 2,2/0,37kW (A2:6)	1430	4/1,25	2.2/0.37	20.100	41	67	3
26168629__PV	HM 63 T4/T8 2,2/0,37kW (A2:9)	1430	4/1,25	2.2/0.37	20.300	44	70	3
26168656__PV	HM 63 T4/T8 2,2/0,37kW (A5:6)	1430	4/1,25	2.2/0.37	18.630	43	72	3
26169629__PV	HM 63 T4/T8 3/0,55kW (A2:9)	1420	6,6/18	3/0.55	21.800	44	77	3
26172626__PV	HM 71 T4/T8 0,75/0,12kW (A2:6)	1430	1,8/1	0.75/0.12	12.000	-	77	3
26172656__PV	HM 71 T4/T8 0,75/0,12kW (A5:6)	1430	1,8/1	0.75/0.12	13.630	50	78	3
26173626__PV	HM 71 T4/T8 1,1/0,18kW (A2:6)	1400	3/0,8	1.1/0.18	15.500	-	78	3
26173629__PV	HM 71 T4/T8 1,1/0,18kW (A2:9)	1400	3/0,8	1.1/0.18	12.100	50	81	3
26173656__PV	HM 71 T4/T8 1,1/0,18kW (A5:6)	1400	3/0,8	1.1/0.18	16.800	49	80	3
26174626__PV	HM 71 T4/T8 1,5/0,25kW (A2:6)	1380	4/1,5	1.5/0.25	20.800	44	82	3
26174629__PV	HM 71 T4/T8 1,5/0,25kW (A2:9)	1380	4/1,5	1.5/0.25	15.700	48	82	3
26174656__PV	HM 71 T4/T8 1,5/0,25kW (A5:6)	1380	4/1,5	1.5/0.25	19.960	48	82	3
26175626__PV	HM 71 T4/T8 2,2/0,37kW (A2:6)	1430	4/1,25	2.2/0.37	25.300	43	84	3
26175629__PV	HM 71 T4/T8 2,2/0,37kW (A2:9)	1430	4/1,25	2.2/0.37	21.600	47	85	3
26175656__PV	HM 71 T4/T8 2,2/0,37kW (A5:6)	1430	4/1,25	2.2/0.37	23.200	46	87	3
26176626__PV	HM 71 T4/T8 3/0,55kW (A2:6)	1420	6,6/18	3/0.55	27.900	44	86	3
26176629__PV	HM 71 T4/T8 3/0,55kW (A2:9)	1420	6,6/18	3/0.55	25.300	47	87	3
26176656__PV	HM 71 T4/T8 3/0,55kW (A5:6)	1420	6,6/18	3/0.55	25.160	48	89	3
26181626__PV	HM 80 T4/T8 1,1/0,18kW (A2:6)	1400	3/0,8	1.1/0.18	15.400	47	85	3
26182626__PV	HM 80 T4/T8 1,5/0,25kW (A2:6)	1380	4/1,5	1.5/0.25	20.300	47	86	3
26182629__PV	HM 80 T4/T8 1,5/0,25kW (A2:9)	1380	4/1,5	1.5/0.25	16.200	55	86	3
26183626__PV	HM 80 T4/T8 2,2/0,37kW (A2:6)	1430	4/1,25	2.2/0.37	27.900	47	87	3
26183629__PV	HM 80 T4/T8 2,2/0,37kW (A2:9)	1430	4/1,25	2.2/0.37	21.200	53	88	3
26184626__PV	HM 80 T4/T8 3/0,55kW (A2:6)	1420	6,6/18	3/0.55	32.500	46	92	3
26184629__PV	HM 80 T4/T8 3/0,55kW (A2:9)	1420	6,6/18	3/0.55	26.400	51	93	3
26184656__PV	HM 80 T4/T8 3/0,55kW (A5:6)	1420	6,6/18	3/0.55	31.090	48	97	3
26185626__PV	HM 80 T4/T8 4/0,75kW (A2:6)	1440	8,5/21,8	4/0.75	36.100	46	108	3
26185629__PV	HM 80 T4/T8 4/0,75kW (A2:9)	1440	8,5/21,8	4/0.75	29.100	51	108	3
26185656__PV	HM 80 T4/T8 4/0,75kW (A5:6)	1440	8,5/21,8	4/0.75	34.000	49	108	3
26186626__PV	HM 80 T4/T8 5,5/1,1kW (A2:6)	1450	11/27,2	5.5/1.1	39.000	46	110	3
26186629__PV	HM 80 T4/T8 5,5/1,1kW (A2:9)	1450	11/27,2	5.5/1.1	36.700	49	110	3
26193663__PV	HM 90 T4/T8 3/0,55kW (A6:3)	1420	6,6/18	3/0.55	30.700	-	105	3
26194663__PV	HM 90 T4/T8 4/0,75kW (A6:3)	1440	8,5/21,8	4/0.75	37.700	48	110	3
26195663__PV	HM 90 T4/T8 5,5/1,1kW (A6:3)	1450	11/27,2	5.5/1.1	41.400	51	119	3
26195666__PV	HM 90 T4/T8 5,5/1,1kW (A6:6)	1450	11/27,2	5.5/1.1	33.400	-	120	3



Code	Model	R.P.M.	Rated I. (A) 400V	Rated power kW	Max. Airflow m3/h	Sound db (A)*	Weight	Connect. diagram
26196663__PV	HM 90 T4/T8 7,5/1,5kW (A6:3)	1450	15/4	7.5/1.5	45.700	52	136	3
26196666__PV	HM 90 T4/T8 7,5/1,5kW (A6:6)	1450	15/4	7.5/1.5	40.800	56	141	3
26197663__PV	HM 90 T4/T8 11/3kW (A6:3)	1460	22/8,5	11/3	49.700	54	181	3
26197666__PV	HM 90 T4/T8 11/3kW (A6:6)	1460	22/8,5	11/3	48.700	54	184	3
26197666__PV	HM 90 T4/T8 15/3,5kW (A6:6)	1460	29,5/11,5	15/3.5	56.500	53	191	3
26114663__PV	HM 100 T4/T8 5,5/1,1kW (A6:3)	1450	11/27,2	5.5/1.1	48.700	-	138	3
26115663__PV	HM 100 T4/T8 7,5/1,5kW (A6:3)	1450	15/4	7.5/1.5	55.500	52	152	3
26115666__PV	HM 100 T4/T8 7,5/1,5kW (A6:6)	1450	15/4	7.5/1.5	44.200	-	155	3
26116663__PV	HM 100 T4/T8 11/3kW (A6:3)	1460	22/8,5	11/3	63.000	53	197	3
26116666__PV	HM 100 T4/T8 11/3kW (A6:6)	1460	22/8,5	11/3	56.200	60	200	3
26116663__PV	HM 100 T4/T8 15/3,5kW (A6:3)	1460	29,5/11,5	15/3.5	67.100	55	192	3
26116666__PV	HM 100 T4/T8 15/3,5kW (A6:6)	1460	29,5/11,5	15/3.5	63.500	59	197	3
26118666__PV	HM 100 T4/T8 17/4,3kW (A6:6)	1475	33,4/12,7	17/4.3	71.200	57	221	3
26119666__PV	HM 100 T4/T8 20/5kW (A6:6)	1470	38,6/14,1	20/5	75.200	58	261	3
26123663__PV	HM 112 T4/T8 5,5/1,1kW (A6:3)	1450	11/27,2	5.5/1.1	52.700	-	165	3
26124663__PV	HM 112 T4/T8 7,5/1,5kW (A6:3)	1450	15/4	7.5/1.5	63.400	58	175	3
26125663__PV	HM 112 T4/T8 11/3kW (A6:3)	1460	22/8,5	11/3	72.600	57	199	3
26125666__PV	HM 112 T4/T8 11/3kW (A6:6)	1460	22/8,5	11/3	55.700	-	204	3
26126663__PV	HM 112 T4/T8 15/3,5kW (A6:3)	1460	29,5/11,5	15/3.5	83.600	57	213	3
26126666__PV	HM 112 T4/T8 15/3,5kW (A6:6)	1460	29,5/11,5	15/3.5	72.700	61	218	3
26127663__PV	HM 112 T4/T8 17/4,3kW (A6:3)	1475	33,4/12,7	17/4.3	87.300	58	233	3
26127666__PV	HM 112 T4/T8 17/4,3kW (A6:6)	1475	33,4/12,7	17/4.3	77.900	61	238	3
26128663__PV	HM 112 T4/T8 20/5kW (A6:3)	1470	38,6/14,1	20/5	89.800	58	270	3
26128666__PV	HM 112 T4/T8 20/5kW (A6:6)	1470	38,6/14,1	20/5	83.100	60	275	3
26129666__PV	HM 112 T4/T8 28/6,5kW (A6:6)	1480	52/18	28/6.5	98.900	59	276	3
26130666__PV	HM 112 T4/T8 35/8kW (A6:6)	1470	67,3/21,8	35/8	104.000	62	400	3
27106674__PV	HM 125 T4/T8 11/3kW (A7:4)	1460	22/8,5	11/3	71.400	67	257	3
27106674__PV	HM 125 T4/T8 15/3,5kW (A7:4)	1460	29,5/11,5	15/3.5	85.800	64	275	3
27106678__PV	HM 125 T4/T8 15/3,5kW (A7:8)	1460	29,5/11,5	15/3.5	66.300	-	280	3
27108674__PV	HM 125 T4/T8 17/4,3kW (A7:4)	1475	33,4/12,7	17/4.3	93.200	62	275	3
27109674__PV	HM 125 T4/T8 20/5kW (A7:4)	1470	38,6/14,1	20/5	99.200	60	316	3
27109678__PV	HM 125 T4/T8 20/5kW (A7:8)	1470	38,6/14,1	20/5	73.800	71	323	3
27110674__PV	HM 125 T4/T8 28/6,5kW (A7:4)	1480	52/18	28/6.5	117.000	59	317	3
27110678__PV	HM 125 T4/T8 28/6,5kW (A7:8)	1480	52/18	28/6.5	90.500	69	324	3
27111674__PV	HM 125 T4/T8 35/8kW (A7:4)	1470	67,3/21,8	35/8	127.000	60	453	3
27111678__PV	HM 125 T4/T8 35/8kW (A7:8)	1470	67,3/21,8	35/8	107.000	66	458	3
27111678__PV	HM 125 T4/T8 37/9,2kW (A7:8)	1485	74,2/25,4	37/9.2	114.000	64	461	3
27112678__PV	HM 125 T4/T8 44/11kW (A7:8)	1480	80,2/27,2	44/11	122.000	63	500	3

**Notes:**

\* Total sound pressure level at the point of maximum flow measured in dB(A) in the suction measured in free field at a distance of 6m from the source

## Dimensions

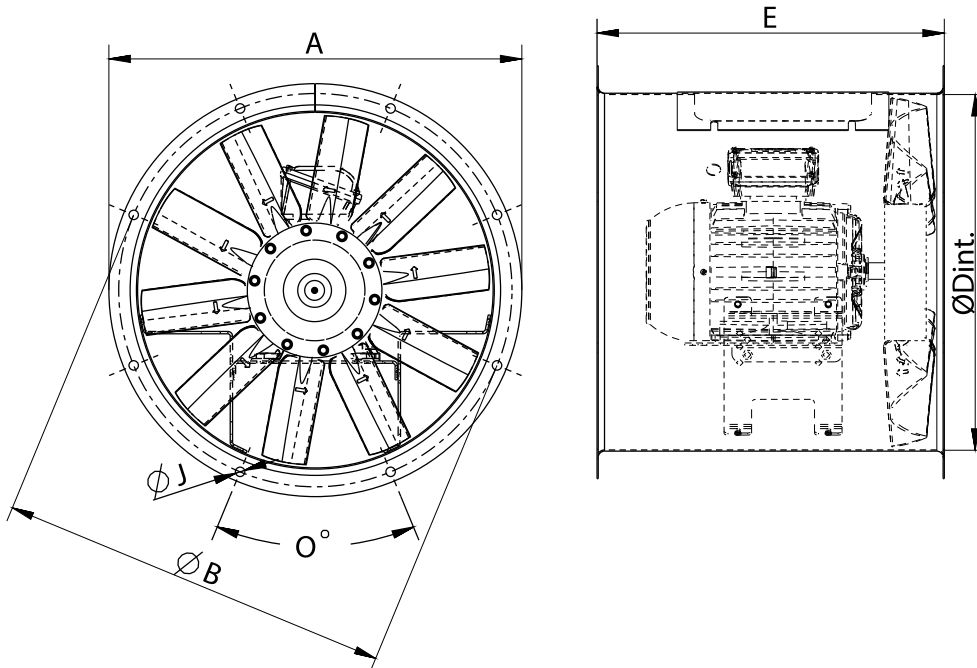

Model	E	O	ØA	ØB	ØDint	ØJ
HM 35 M2 0,55kW (A0:6)	395	8x45°	434	395	365	10
HM 35 M2 1,1kW (A0:6)	395	8x45°	434	395	365	10
HM 35 M4 0,12kW (A0:6)	350	8x45°	434	395	365	10
HM 35 T2 0,55kW (A0:6)	395	8x45°	434	395	365	10
HM 35 T2 1,1kW (A0:6)	395	8x45°	434	395	365	10
HM 35 T4 0,12kW (A0:6)	350	8x45°	434	395	365	10
HM 40 M4 0,25kW (A0:6)	440	8x45°	472	450	403	10
HM 40 M6 0,04kW (A0:6)	440	8x45°	472	450	403	10
HM 40 T2 1,1kW (A0:6)	440	8x45°	472	450	403	10
HM 40 T4 0,25kW (A0:6)	440	8x45°	472	450	403	10
HM 40 T6 0,12kW (A0:6)	440	8x45°	472	450	403	10
HM 45 M4 0,37kW (A0:6)	455	8x45°	525	500	452	12
HM 45 M6 0,13kW (A0:6)	455	8x45°	525	500	452	12
HM 45 T2 0,75kW (A9:4)	455	8X45°	525	500	452	12
HM 45 T2 1,1kW (A9:4)	455	8X45°	525	500	452	12
HM 45 T2 1,1kW (A9:8)	455	8x45°	525	500	452	12
HM 45 T2 1,5kW (A0:6)	455	8x45°	525	500	452	12
HM 45 T2 1,5kW (A9:4)	455	8X45°	525	500	452	12
HM 45 T2 1,5kW (A9:8)	455	8X45°	525	500	452	12
HM 45 T2 2,2kW (A0:6)	455	8x45°	525	500	452	12
HM 45 T2 2,2kW (A9:4)	455	8X45°	525	500	452	12



Model	E	O	ØA	ØB	ØDint	ØJ
HM 45 T2 2,2kW (A9:8)	455	8X45°	525	500	452	12
HM 45 T2 3kW (A9:4)	455	8X45°	525	500	452	12
HM 45 T2 3kW (A9:8)	455	8X45°	525	500	452	12
HM 45 T4 0,55kW (A0:6)	455	8x45°	525	500	452	12
HM 45 T6 0,13kW (A0:6)	455	8x45°	525	500	452	12
HM 45 T2/T4 0,75/0,18kW (A9:4)	455	8X45°	525	500	452	12
HM 45 T2/T4 1,1/0,25kW (A9:4)	455	8X45°	525	500	452	12
HM 45 T2/T4 1,1/0,25kW (A9:8)	455	8x45°	525	500	452	12
HM 45 T2/T4 1,5/0,37kW (A9:4)	455	8X45°	525	500	452	12
HM 45 T2/T4 1,5/0,37kW (A9:8)	455	8X45°	525	500	452	12
HM 45 T2/T4 2,2/0,55kW (A9:4)	455	8X45°	525	500	452	12
HM 45 T2/T4 2,2/0,55kW (A9:8)	455	8X45°	525	500	452	12
HM 45 T2/T4 3/0,75kW (A9:4)	455	8X45°	525	500	452	12
HM 45 T2/T4 3/0,75kW (A9:8)	455	8X45°	525	500	452	12
HM 45 T4/T6 0,55/0,18kW (A0:6)	455	8x45°	525	500	452	12
HM 45 T4/T8 0,33/0,04kW (A0:6)	455	8x45°	525	500	452	12
HM 50 M4 0,55kW (A0:6)	440	12x30°	600	560	504	12
HM 50 M6 0,13kW (A0:6)	440	12x30°	600	560	504	12
HM 50 T2 1,1kW (A9:4)	440	12X30°	600	560	504	12
HM 50 T2 1,5kW (A9:4)	540	12X30°	600	560	504	12
HM 50 T2 1,5kW (A9:8)	540	12x30°	600	560	504	12
HM 50 T2 2,2kW (A9:4)	540	12X30°	600	560	504	12
HM 50 T2 2,2kW (A9:8)	540	12X30°	600	560	504	12
HM 50 T2 3kW (A9:4)	540	12X30°	600	560	504	12
HM 50 T2 3kW (A9:8)	540	12x30°	600	560	504	12
HM 50 T2 4kW (A9:4)	540	12X30°	600	560	504	12
HM 50 T2 4kW (A9:8)	540	12X30°	600	560	504	12
HM 50 T4 0,55kW (A0:6)	440	12x30°	600	560	504	12
HM 50 T6 0,13kW (A0:6)	440	12x30°	600	560	504	12
HM 50 T2/T4 1,1/0,25kW (A9:4)	440	12X30°	600	560	504	12
HM 50 T2/T4 1,5/0,37KW (A9:8)	540	12x30°	600	560	504	12
HM 50 T2/T4 1,5/0,37kW (A9:4)	540	12X30°	600	560	504	12
HM 50 T2/T4 2,2/0,55kW (A9:4)	540	12X30°	600	560	504	12
HM 50 T2/T4 2,2/0,55kW (A9:8)	540	12X30°	600	560	504	12
HM 50 T2/T4 3/0,75kW (A9:4)	540	12X30°	600	560	504	12
HM 50 T2/T4 3/0,75kW (A9:8)	540	12x30°	600	560	504	12
HM 50 T2/T4 4,5/0,9kW (A9:4)	540	12X30°	600	560	504	12
HM 50 T2/T4 4,5/0,9kW (A9:8)	540	12X30°	600	560	504	12
HM 50 T4/T6 0,55/0,18kW (A0:6)	440	12x30°	600	560	504	12
HM 50 T4/T8 0,55/0,09kW (A0:6)	440	12x30°	600	560	504	12

Model	E	O	ØA	ØB	ØDint	ØJ
HM 56 M4 0,37kW (A5:6)	560	12x30°	646	620	559	12
HM 56 M4 0,55kW (A2:6)	560	12x30°	646	620	559	12
HM 56 M4 0,55kW (A5:6)	560	12x30°	646	620	559	12
HM 56 M6 0,25kW (A2:6)	560	12x30°	646	620	559	12
HM 56 M6 0,25kW (A5:6)	560	12x30°	646	620	559	12
HM 56 M6 0,37kW (A2:6)	560	12x30°	646	620	559	12
HM 56 M6 0,37kW (A5:6)	560	12x30°	646	620	559	12
HM 56 T2 1,5kW (A9:4)	560	12X30°	656	620	559	12
HM 56 T2 2,2kW (A9:4)	560	12X30°	656	620	559	12
HM 56 T2 2,2kW (A9:8)	560	12X30°	656	620	559	12
HM 56 T2 3kW (A9:4)	560	12X30°	656	620	559	12
HM 56 T2 3kW (A9:8)	560	12X30°	656	620	559	12
HM 56 T2 4kW (A9:4)	560	12X30°	656	620	559	12
HM 56 T2 4kW (A9:8)	560	12x30°	646	620	559	12
HM 56 T2 5,5kW (A9:5)	560	12X30°	656	620	559	12
HM 56 T2 5,5kW (A9:10)	560	12X30°	656	620	559	12
HM 56 T2 7,5kW (A9:10)	560	12X30°	656	620	559	12
HM 56 T4 0,37kW (A5:6)	560	12x30°	646	620	559	12
HM 56 T4 0,55kW (A2:6)	560	12x30°	646	620	559	12
HM 56 T4 0,55kW (A2:9)	560	12x30°	646	620	559	12
HM 56 T4 0,55kW (A5:6)	560	12x30°	646	620	559	12
HM 56 T4 0,75kW (A2:6)	560	12x30°	646	620	559	12
HM 56 T4 0,75kW (A2:9)	560	12x30°	646	620	559	12
HM 56 T4 0,75kW (A5:6)	560	12x30°	646	620	559	12
HM 56 T4 1,1kW (A2:6)	560	12x30°	646	620	559	12
HM 56 T4 1,1kW (A2:9)	560	12x30°	646	620	559	12
HM 56 T4 1,1kW (A5:6)	560	12x30°	646	620	559	12
HM 56 T4 1,5kW (A2:6)	560	12X30°	646	620	559	12
HM 56 T4 1,5kW (A2:9)	560	12x30°	646	620	559	12
HM 56 T4 1,5kW (A5:6)	560	12x30°	646	620	559	12
HM 56 T6 0,25kW (A5:6)	560	12x30°	646	620	559	12
HM 56 T6 0,37kW (A5:6)	560	12x30°	646	620	559	12
HM 56 T6 0,55kW (A2:6)	560	12x30°	646	620	559	12
HM 56 T6 0,55kW (A2:9)	560	12X30°	646	620	559	12
HM 56 T2/T4 1,5/0,37kW (A9:4)	560	12X30°	656	620	559	12
HM 56 T2/T4 2,2/0,55kW (A9:4)	560	12X30°	656	620	559	12
HM 56 T2/T4 2,2/0,55kW (A9:8)	560	12X30°	656	620	559	12
HM 56 T2/T4 3/0,75kW (A9:4)	560	12X30°	656	620	559	12
HM 56 T2/T4 3/0,75kW (A9:8)	560	12X30°	656	620	559	12
HM 56 T2/T4 4,5/0,9kW (A9:4)	560	12X30°	656	620	559	12

Model	E	O	ØA	ØB	ØDint	ØJ
HM 56 T2/T4 4,5/0,9kW (A9:8)	560	12x30°	646	620	559	12
HM 56 T2/T4 5,5/1,5kW (A9:5)	560	12X30°	656	620	559	12
HM 56 T2/T4 5,5/1,5kW (A9:10)	560	12X30°	656	620	559	12
HM 56 T2/T4 8/1,85kW (A9:10)	560	12X30°	656	620	559	12
HM 56 T4/T6 0,37/0,13kW (A5:6)	560	12x30°	646	620	559	12
HM 56 T4/T6 0,55/0,18kW (A2:6)	560	12x30°	646	620	559	12
HM 56 T4/T6 0,55/0,18kW (A2:9)	560	12x30°	646	620	559	12
HM 56 T4/T6 0,55/0,18kW (A5:6)	560	12x30°	646	620	559	12
HM 56 T4/T6 0,75/0,25kW (A2:6)	560	12x30°	646	620	559	12
HM 56 T4/T6 0,75/0,25kW (A2:9)	560	12x30°	646	620	559	12
HM 56 T4/T6 0,75/0,25kW (A5:6)	560	12x30°	646	620	559	12
HM 56 T4/T6 1,1/0,37kW (A2:6)	560	12x30°	646	620	559	12
HM 56 T4/T6 1,1/0,37kW (A2:9)	560	12x30°	646	620	559	12
HM 56 T4/T6 1,1/0,37kW (A5:6)	560	12x30°	646	620	559	12
HM 56 T4/T6 1,5/0,5kW (A2:6)	560	12X30°	646	620	559	12
HM 56 T4/T6 1,5/0,5kW (A2:9)	560	12x30°	646	620	559	12
HM 56 T4/T6 1,5/0,5kW (A5:6)	560	12x30°	646	620	559	12
HM 56 T4/T8 0,33/0,04kW (A5:6)	560	12x30°	646	620	559	12
HM 56 T4/T8 0,55/0,09kW (A2:6)	560	12X30°	646	620	559	12
HM 56 T4/T8 0,55/0,09kW (A2:9)	560	12X30°	646	620	559	12
HM 56 T4/T8 0,55/0,09kW (A5:6)	560	12x30°	646	620	559	12
HM 56 T4/T8 0,75/0,12kW (A2:6)	560	12X30°	646	620	559	12
HM 56 T4/T8 0,75/0,12kW (A2:9)	560	12X30°	646	620	559	12
HM 56 T4/T8 0,75/0,12kW (A5:6)	560	12x30°	646	620	559	12
HM 56 T4/T8 1,1/0,18kW (A2:6)	560	12x30°	646	620	559	12
HM 56 T4/T8 1,1/0,18kW (A2:9)	560	12x30°	646	620	559	12
HM 56 T4/T8 1,1/0,18kW (A5:6)	560	12x30°	646	620	559	12
HM 56 T4/T8 1,5/0,25kW (A2:6)	560	12X30°	646	620	559	12
HM 56 T4/T8 1,5/0,25kW (A2:9)	560	12x30°	646	620	559	12
HM 56 T4/T8 1,5/0,25kW (A5:6)	560	12x30°	646	620	559	12
HM 63 M6 0,37kW (A5:6)	550	12x30°	725	690	633	12
HM 63 M6 0,55kW (A2:9)	550	12x30°	725	690	633	12
HM 63 M6 0,55kW (A5:6)	550	12x30°	725	690	633	12
HM 63 T2 1,5kW (A9:4)	550	12X30°	725	690	633	12
HM 63 T2 2,2kW (A9:4)	550	12X30°	725	690	633	12
HM 63 T2 3kW (A9:4)	770	12x30°	725	690	633	12
HM 63 T2 3kW (A9:8)	770	12X30°	725	690	633	12
HM 63 T2 4kW (A9:4)	770	12X30°	725	690	633	12
HM 63 T2 4kW (A9:8)	770	12X30°	725	690	633	12
HM 63 T2 5,5kW (A9:10)	770	12X30°	725	690	633	12

Model	E	O	ØA	ØB	ØDint	ØJ
HM 63 T2 7,5kW (A9:5)	770	12X30°	725	690	633	12
HM 63 T2 7,5kW (A9:10)	770	12X30°	725	690	633	12
HM 63 T2 11kW (A9:5)	770	12X30°	725	690	633	12
HM 63 T2 11kW (A9:10)	770	12X30°	725	690	633	12
HM 63 T2 15kW (A9:10)	770	12X30°	725	690	633	12
HM 63 T4 0,55kW (A2:6)	550	12x30°	725	690	633	12
HM 63 T4 0,75kW (A2:6)	550	12x30°	725	690	633	12
HM 63 T4 0,75kW (A2:9)	550	12x30°	725	690	633	12
HM 63 T4 0,75kW (A5:6)	550	12x30°	725	690	633	12
HM 63 T4 1,1kW (A2:6)	550	12x30°	725	690	633	12
HM 63 T4 1,1kW (A2:9)	550	12x30°	725	690	633	12
HM 63 T4 1,1kW (A5:6)	550	12x30°	725	690	633	12
HM 63 T4 1,5kW (A2:6)	550	12x30°	725	690	633	12
HM 63 T4 1,5kW (A2:9)	550	12x30°	725	690	633	12
HM 63 T4 1,5kW (A5:6)	550	12x30°	725	690	633	12
HM 63 T4 2,2kW (A2:6)	550	12x30°	725	690	633	12
HM 63 T4 2,2kW (A2:9)	550	12x30°	725	690	633	12
HM 63 T4 2,2kW (A5:6)	550	12x30°	725	690	633	12
HM 63 T4 3kW (A2:9)	550	12x30°	725	690	633	12
HM 63 T6 0,37kW (A5:6)	550	12x30°	725	690	633	12
HM 63 T6 0,55kW (A2:6)	550	12x30°	725	690	633	12
HM 63 T6 0,55kW (A2:9)	550	12x30°	725	690	633	12
HM 63 T6 0,55kW (A5:6)	550	12x30°	725	690	633	12
HM 63 T6 0,75kW (A2:9)	550	12x30°	725	690	633	12
HM 63 T2/T4 1,5/0,37kW (A9:4)	550	12X30°	725	690	633	12
HM 63 T2/T4 2,2/0,55kW (A9:4)	550	12X30°	725	690	633	12
HM 63 T2/T4 3/0,75kW (A9:4)	770	12x30°	725	690	633	12
HM 63 T2/T4 3/0,75kW (A9:8)	770	12X30°	725	690	633	12
HM 63 T2/T4 4,5/0,9kW (A9:4)	770	12X30°	725	690	633	12
HM 63 T2/T4 4,5/0,9kW (A9:8)	770	12X30°	725	690	633	12
HM 63 T2/T4 5,5/1,5kW (A9:10)	770	12X30°	725	690	633	12
HM 63 T2/T4 8/1,85kW (A9:5)	770	12X30°	725	690	633	12
HM 63 T2/T4 8/1,85kW (A9:10)	770	12X30°	725	690	633	12
HM 63 T2/T4 11/2,8kW (A9:5)	770	12X30°	725	690	633	12
HM 63 T2/T4 11/3kW (A9:10)	770	12X30°	725	690	633	12
HM 63 T2/T4 15/4kW (A9:10)	770	12X30°	725	690	633	12
HM 63 T4/T6 0,55/0,18kW (A2:6)	550	12x30°	725	690	633	12
HM 63 T4/T6 0,75/0,25kW (A2:6)	550	12x30°	725	690	633	12
HM 63 T4/T6 0,75/0,25kW (A2:9)	550	12x30°	725	690	633	12
HM 63 T4/T6 0,75/0,25kW (A5:6)	550	12x30°	725	690	633	12

Model	E	O	ØA	ØB	ØDint	ØJ
HM 63 T4/T6 1,1/0,37kW (A2:6)	550	12x30°	725	690	633	12
HM 63 T4/T6 1,1/0,37kW (A2:9)	550	12x30°	725	690	633	12
HM 63 T4/T6 1,1/0,37kW (A5:6)	550	12x30°	725	690	633	12
HM 63 T4/T6 1,5/0,5kW (A2:6)	550	12x30°	725	690	633	12
HM 63 T4/T6 1,5/0,5kW (A2:9)	550	12x30°	725	690	633	12
HM 63 T4/T6 1,5/0,5kW (A5:6)	550	12x30°	725	690	633	12
HM 63 T4/T6 2,2/0,6kW (A2:6)	550	12x30°	725	690	633	12
HM 63 T4/T6 2,2/0,6kW (A2:9)	550	12x30°	725	690	633	12
HM 63 T4/T6 2,2/0,6kW (A5:6)	550	12x30°	725	690	633	12
HM 63 T4/T6 3/0,9kW (A2:9)	550	12x30°	725	690	633	12
HM 63 T4/T8 0,55/0,09kW (A2:6)	550	12X30°	725	690	633	12
HM 63 T4/T8 0,75/0,12kW (A2:6)	550	12X30°	725	690	633	12
HM 63 T4/T8 0,75/0,12kW (A2:9)	550	12X30°	725	690	633	12
HM 63 T4/T8 0,75/0,12kW (A5:6)	550	12x30°	725	690	633	12
HM 63 T4/T8 1,1/0,18kW (A2:6)	550	12X30°	725	690	633	12
HM 63 T4/T8 1,1/0,18kW (A2:9)	550	12X30°	725	690	633	12
HM 63 T4/T8 1,1/0,18kW (A5:6)	550	12x30°	725	690	633	12
HM 63 T4/T8 1,5/0,25kW (A2:6)	550	12X30°	725	690	633	12
HM 63 T4/T8 1,5/0,25kW (A2:9)	550	12X30°	725	690	633	12
HM 63 T4/T8 1,5/0,25kW (A5:6)	550	12x30°	725	690	633	12
HM 63 T4/T8 2,2/0,37kW (A2:6)	550	12X30°	725	690	633	12
HM 63 T4/T8 2,2/0,37kW (A2:9)	550	12X30°	725	690	633	12
HM 63 T4/T8 2,2/0,37kW (A5:6)	550	12x30°	725	690	633	12
HM 63 T4/T8 3/0,55kW (A2:9)	550	12X30°	725	690	633	12
HM 71 M6 0,55kW (A2:6)	600	16x22,5°	802	770	715	12
HM 71 M6 0,55kW (A2:9)	600	16x22,5°	802	770	715	12
HM 71 T4 0,75kW (A2:6)	600	16x22,5°	802	770	715	12
HM 71 T4 0,75kW (A5:6)	600	16x22,5°	802	770	715	12
HM 71 T4 1,1kW (A2:6)	600	16x22,5°	802	770	715	12
HM 71 T4 1,1kW (A2:9)	600	16x22,5°	802	770	715	12
HM 71 T4 1,1kW (A5:6)	600	16x22,5°	802	770	715	12
HM 71 T4 1,5kW (A2:6)	600	16x22,5°	802	770	715	12
HM 71 T4 1,5kW (A2:9)	600	16x22,5°	802	770	715	12
HM 71 T4 1,5kW (A5:6)	600	16x22,5°	802	770	715	12
HM 71 T4 2,2kW (A2:6)	600	16x22,5°	802	770	715	12
HM 71 T4 2,2kW (A2:9)	600	16x22,5°	802	770	715	12
HM 71 T4 2,2kW (A5:6)	600	16x22,5°	802	770	715	12
HM 71 T4 3kW (A2:6)	600	16x22,5°	802	770	715	12
HM 71 T4 3kW (A2:9)	600	16x22,5°	802	770	715	12
HM 71 T4 3kW (A5:6)	600	16x22,5°	802	770	715	12

Model	E	O	ØA	ØB	ØDint	ØJ
HM 71 T6 0,55kW (A2:6)	600	16x22,5°	802	770	715	12
HM 71 T6 0,55kW (A2:9)	600	16x22,5°	802	770	715	12
HM 71 T6 0,75kW (A2:6)	600	16x22,5°	802	770	715	12
HM 71 T6 0,75kW (A2:9)	600	16x22,5°	802	770	715	12
HM 71 T6 0,75kW (A5:6)	600	16x22,5°	802	770	715	12
HM 71 T6 1,1kW (A2:9)	600	16x22,5°	802	770	715	12
HM 71 T4/T6 0,75/0,25kW (A2:6)	600	16x22,5°	802	770	715	12
HM 71 T4/T6 0,75/0,25kW (A5:6)	600	16x22,5°	802	770	715	12
HM 71 T4/T6 1,1/0,37kW (A2:6)	600	16x22,5°	802	770	715	12
HM 71 T4/T6 1,1/0,37kW (A2:9)	600	16x22,5°	802	770	715	12
HM 71 T4/T6 1,1/0,37kW (A5:6)	600	16x22,5°	802	770	715	12
HM 71 T4/T6 1,5/0,5kW (A2:6)	600	16x22,5°	802	770	715	12
HM 71 T4/T6 1,5/0,5kW (A2:9)	600	16x22,5°	802	770	715	12
HM 71 T4/T6 1,5/0,5kW (A5:6)	600	16x22,5°	802	770	715	12
HM 71 T4/T6 2,2/0,6kW (A2:6)	600	16x22,5°	802	770	715	12
HM 71 T4/T6 2,2/0,6kW (A2:9)	600	16x22,5°	802	770	715	12
HM 71 T4/T6 2,2/0,6kW (A5:6)	600	16x22,5°	802	770	715	12
HM 71 T4/T6 3/0,9kW (A2:6)	600	16x22,5°	802	770	715	12
HM 71 T4/T6 3/0,9kW (A2:9)	600	16x22,5°	802	770	715	12
HM 71 T4/T6 3/0,9kW (A5:6)	600	16x22,5°	802	770	715	12
HM 71 T4/T8 0,75/0,12kW (A2:6)	600	16x22,5°	802	770	715	12
HM 71 T4/T8 0,75/0,12kW (A5:6)	600	16x22,5°	802	770	715	12
HM 71 T4/T8 1,1/0,18kW (A2:6)	600	16x22,5°	802	770	715	12
HM 71 T4/T8 1,1/0,18kW (A2:9)	600	16x22,5°	802	770	715	12
HM 71 T4/T8 1,1/0,18kW (A5:6)	600	16x22,5°	802	770	715	12
HM 71 T4/T8 1,5/0,25kW (A2:6)	600	16x22,5°	802	770	715	12
HM 71 T4/T8 1,5/0,25kW (A2:9)	600	16x22,5°	802	770	715	12
HM 71 T4/T8 1,5/0,25kW (A5:6)	600	16x22,5°	802	770	715	12
HM 71 T4/T8 2,2/0,37kW (A2:6)	600	16x22,5°	802	770	715	12
HM 71 T4/T8 2,2/0,37kW (A2:9)	600	16x22,5°	802	770	715	12
HM 71 T4/T8 2,2/0,37kW (A5:6)	600	16x22,5°	802	770	715	12
HM 71 T4/T8 3/0,55kW (A2:6)	600	16x22,5°	802	770	715	12
HM 71 T4/T8 3/0,55kW (A2:9)	600	16x22,5°	802	770	715	12
HM 71 T4/T8 3/0,55kW (A5:6)	600	16x22,5°	802	770	715	12
HM 80 T4 1,1KW (A2:6)	600	16x22,5°	892	860	801	12
HM 80 T4 1,5KW (A2:6)	600	16x22,5°	892	860	801	12
HM 80 T4 1,5KW (A2:9)	600	16x22,5°	892	860	801	12
HM 80 T4 2,2kW (A2:6)	600	16x22,5°	892	860	801	12
HM 80 T4 2,2kW (A2:9)	600	16x22,5°	892	860	801	12
HM 80 T4 3kW (A2:6)	600	16x22,5°	892	860	801	12



Model	E	O	ØA	ØB	ØDint	ØJ
HM 80 T4 3kW (A2:9)	600	16x22,5°	892	860	801	12
HM 80 T4 3kW (A5:6)	600	16x22,5°	892	860	801	12
HM 80 T4 4kW (A2:6)	600	16x22,5°	892	860	801	12
HM 80 T4 4kW (A2:9)	600	16x22,5°	892	860	801	12
HM 80 T4 4kW (A5:6)	600	16x22,5°	892	860	801	12
HM 80 T4 5,5kW (A2:6)	600	16x22,5°	892	860	801	12
HM 80 T4 5,5kW (A2:9)	600	16x22,5°	892	860	801	12
HM 80 T6 0,75kW (A2:6)	600	16x22,5°	892	860	801	12
HM 80 T6 0,75kW (A2:9)	600	16x22,5°	892	860	801	12
HM 80 T6 0,75kW (A5:6)	600	16x22,5°	892	860	801	12
HM 80 T6 1,1kW (A2:6)	600	16x22,5°	892	860	801	12
HM 80 T6 1,1kW (A2:9)	600	16x22,5°	892	860	801	12
HM 80 T6 1,1kW (A5:6)	600	16x22,5°	892	860	801	12
HM 80 T6 1,5kW (A2:6)	600	16x22,5°	892	860	801	12
HM 80 T6 1,5kW (A2:9)	600	16x22,5°	892	860	801	12
HM 80 T6 1,5kW (A5:6)	600	16x22,5°	892	860	801	12
HM 80 T6 2,2kW (A2:9)	600	16x22,5°	892	860	801	12
HM 80 T6 2,2kW (A5:6)	600	16x22,5°	892	860	801	12
HM 80 T4/T6 1,1/0,37kW (A2:6)	600	16x22,5°	892	860	801	12
HM 80 T4/T6 1,5/0,5kW (A2:6)	600	16x22,5°	892	860	801	12
HM 80 T4/T6 1,5/0,5kW (A2:9)	600	16x22,5°	892	860	801	12
HM 80 T4/T6 2,2/0,6kW (A2:6)	600	16x22,5°	892	860	801	12
HM 80 T4/T6 2,2/0,6kW (A2:9)	600	16x22,5°	892	860	801	12
HM 80 T4/T6 3/0,9kW (A2:6)	600	16x22,5°	892	860	801	12
HM 80 T4/T6 3/0,9kW (A2:9)	600	16x22,5°	892	860	801	12
HM 80 T4/T6 3/0,9kW (A5:6)	600	16x22,5°	892	860	801	12
HM 80 T4/T6 4/1,1kW (A2:6)	600	16x22,5°	892	860	801	12
HM 80 T4/T6 4/1,1kW (A2:9)	600	16x22,5°	892	860	801	12
HM 80 T4/T6 4/1,1kW (A5:6)	600	16x22,5°	892	860	801	12
HM 80 T4/T6 5,5/1,85kW (A2:6)	600	16x22,5°	892	860	801	12
HM 80 T4/T6 5,5/1,85kW (A2:9)	600	16x22,5°	892	860	801	12
HM 80 T4/T8 1,1/0,18kW (A2:6)	600	16X22,5°	892	860	801	12
HM 80 T4/T8 1,5/0,25kW (A2:6)	600	16X22,5°	892	860	801	12
HM 80 T4/T8 1,5/0,25kW (A2:9)	600	16X22,5°	892	860	801	12
HM 80 T4/T8 2,2/0,37kW (A2:6)	600	16X22,5°	892	860	801	12
HM 80 T4/T8 2,2/0,37kW (A2:9)	600	16X22,5°	892	860	801	12
HM 80 T4/T8 3/0,55kW (A2:6)	600	16X22,5°	892	860	801	12
HM 80 T4/T8 3/0,55kW (A2:9)	600	16X22,5°	892	860	801	12
HM 80 T4/T8 3/0,55kW (A5:6)	600	16x22,5°	892	860	801	12
HM 80 T4/T8 4/0,75kW (A2:6)	600	16X22,5°	892	860	801	12

Model	E	O	ØA	ØB	ØDint	ØJ
HM 80 T4/T8 4/0,75kW (A2:9)	600	16X22,5°	892	860	801	12
HM 80 T4/T8 4/0,75kW (A5:6)	600	16x22,5°	892	860	801	12
HM 80 T4/T8 5,5/1,1kW (A2:6)	600	16X22,5°	892	860	801	12
HM 80 T4/T8 5,5/1,1kW (A2:9)	600	16X22,5°	892	860	801	12
HM 90 T4 3kW (A6:3)	820	16X22,5°	1000	970	903,5	12
HM 90 T4 4kW (A6:3)	820	16X22,5°	1000	970	903,5	12
HM 90 T4 5,5kW (A6:3)	820	16X22,5°	1000	970	903,5	12
HM 90 T4 5,5kW (A6:6)	820	16X22,5°	1000	970	903,5	12
HM 90 T4 7,5kW (A6:3)	820	16X22,5°	1000	970	903,5	12
HM 90 T4 7,5kW (A6:6)	820	16X22,5°	1000	970	903,5	12
HM 90 T4 11kW (A6:3)	820	16X22,5°	1000	970	903,5	12
HM 90 T4 11kW (A6:6)	820	16X22,5°	1000	970	903,5	12
HM 90 T4 15kW (A6:6)	820	16X22,5°	1000	970	903,5	12
HM 90 T6 1,5kW (A6:3)	820	16X22,5°	1000	970	903,5	12
HM 90 T6 1,5kW (A6:6)	820	16X22,5°	1000	970	903,5	12
HM 90 T6 2,2kW (A6:3)	820	16X22,5°	1000	970	903,5	12
HM 90 T6 2,2kW (A6:6)	820	16X22,5°	1000	970	903,5	12
HM 90 T6 3kW (A6:3)	820	16X22,5°	1000	970	903,5	12
HM 90 T6 3kW (A6:6)	820	16X22,5°	1000	970	903,5	12
HM 90 T6 4kW (A6:6)	820	16X22,5°	1000	970	903,5	12
HM 90 T4/T6 3/0,9kW (A6:3)	820	16X22,5°	1000	970	903,5	12
HM 90 T4/T6 4/1,1kW (A6:3)	820	16X22,5°	1000	970	903,5	12
HM 90 T4/T6 5,5/1,85kW (A6:3)	820	16X22,5°	1000	970	903,5	12
HM 90 T4/T6 5,5/1,85kW (A6:6)	820	16X22,5°	1000	970	903,5	12
HM 90 T4/T6 7,5/2,2kW (A6:3)	820	16X22,5°	1000	970	903,5	12
HM 90 T4/T6 7,5/2,2kW (A6:6)	820	16X22,5°	1000	970	903,5	12
HM 90 T4/T6 11/3,6kW (A6:3)	820	16X22,5°	1000	970	903,5	12
HM 90 T4/T6 11/3,6kW (A6:6)	820	16X22,5°	1000	970	903,5	12
HM 90 T4/T6 15/4,4kW (A6:6)	820	16X22,5°	1000	970	903,5	12
HM 90 T4/T8 3/0,55kW (A6:3)	820	16X22,5°	1000	970	903,5	12
HM 90 T4/T8 4/0,75kW (A6:3)	820	16X22,5°	1000	970	903,5	12
HM 90 T4/T8 5,5/1,1kW (A6:3)	820	16X22,5°	1000	970	903,5	12
HM 90 T4/T8 5,5/1,1kW (A6:6)	820	16X22,5°	1000	970	903,5	12
HM 90 T4/T8 7,5/1,5kW (A6:3)	820	16X22,5°	1000	970	903,5	12
HM 90 T4/T8 7,5/1,5kW (A6:6)	820	16X22,5°	1000	970	903,5	12
HM 90 T4/T8 11/3kW (A6:3)	600	16x22,5°	892	860	801	12
HM 90 T4/T8 11/3kW (A6:6)	600	16x22,5°	892	860	801	12
HM 90 T4/T8 15/3,5kW (A6:6)	820	16X22,5°	1000	970	903,5	12
HM 100 T4 5,5kW (A6:3)	820	16x22,5°	1115	1070	1013	12
HM 100 T4 7,5kW (A6:3)	820	16x22,5°	1115	1070	1013	12



Model	E	O	ØA	ØB	ØDint	ØJ
HM 100 T4 7,5kW (A6:6)	820	16x22,5°	1115	1070	1013	12
HM 100 T4 11kW (A6:3)	820	16x22,5°	1115	1070	1013	12
HM 100 T4 11kW (A6:6)	820	16x22,5°	1115	1070	1013	12
HM 100 T4 15kW (A6:3)	820	16x22,5°	1115	1070	1013	12
HM 100 T4 15kW (A6:6)	820	16x22,5°	1115	1070	1013	12
HM 100 T4 18,5kW (A6:6)	820	16x22,5°	1115	1070	1013	12
HM 100 T4 22kW (A6:6)	820	16x22,5°	1115	1070	1013	12
HM 100 T6 1,5kW (A6:3)	820	16x22,5°	1115	1070	1013	12
HM 100 T6 2,2kW (A6:3)	820	16x22,5°	1115	1070	1013	12
HM 100 T6 2,2kW (A6:6)	820	16x22,5°	1115	1070	1013	12
HM 100 T6 3kW (A6:3)	820	16x22,5°	1115	1070	1013	12
HM 100 T6 3kW (A6:6)	820	16x22,5°	1115	1070	1013	12
HM 100 T6 4kW (A6:3)	820	16x22,5°	1115	1070	1013	12
HM 100 T6 4kW (A6:6)	820	16x22,5°	1115	1070	1013	12
HM 100 T6 5,5kW (A6:6)	820	16x22,5°	1115	1070	1013	12
HM 100 T6 7,5kW (A6:6)	820	16x22,5°	1115	1070	1013	12
HM 100 T4/T6 5,5/1,85kW (A6:3)	820	16x22,5°	1115	1070	1013	12
HM 100 T4/T6 7,5/2,2kW (A6:3)	820	16x22,5°	1115	1070	1013	12
HM 100 T4/T6 7,5/2,2kW (A6:6)	820	16x22,5°	1115	1070	1013	12
HM 100 T4/T6 11/3,6kW (A6:3)	820	16x22,5°	1115	1070	1013	12
HM 100 T4/T6 11/3,6kW (A6:6)	820	16x22,5°	1115	1070	1013	12
HM 100 T4/T6 15/4,4kW (A6:3)	820	16x22,5°	1115	1070	1013	12
HM 100 T4/T6 15/4,4kW (A6:6)	820	16x22,5°	1115	1070	1013	12
HM 100 T4/T6 18,5/6kW (A6:6)	820	16x22,5°	1115	1070	1013	12
HM 100 T4/T6 22/7,5kW (A6:6)	820	16x22,5°	1115	1070	1013	12
HM 100 T4/T8 5,5/1,1kW (A6:3)	820	16x22,5°	1115	1070	1013	12
HM 100 T4/T8 7,5/1,5kW (A6:3)	820	16x22,5°	1115	1070	1013	12
HM 100 T4/T8 7,5/1,5kW (A6:6)	820	16x22,5°	1115	1070	1013	12
HM 100 T4/T8 11/3kW (A6:3)	820	16x22,5°	1115	1070	1013	12
HM 100 T4/T8 11/3kW (A6:6)	820	16x22,5°	1115	1070	1013	12
HM 100 T4/T8 15/3,5kW (A6:3)	820	16x22,5°	1115	1070	1013	12
HM 100 T4/T8 15/3,5kW (A6:6)	820	16x22,5°	1115	1070	1013	12
HM 100 T4/T8 17/4,3kW (A6:6)	820	16x22,5°	1115	1070	1013	12
HM 100 T4/T8 20/5kW (A6:6)	820	16x22,5°	1115	1070	1013	12
HM 112 T4 5,5kW (A6:3)	1000	16x22,5°	1234	1190	1132	12
HM 112 T4 7,5kW (A6:3)	1000	16x22,5°	1234	1190	1132	12
HM 112 T4 11kW (A6:3)	1000	16x22,5°	1234	1190	1132	12
HM 112 T4 11kW (A6:6)	1000	16x22,5°	1234	1190	1132	12
HM 112 T4 15kW (A6:3)	1000	16x22,5°	1234	1190	1132	12
HM 112 T4 15kW (A6:6)	1000	16x22,5°	1234	1190	1132	12

Model	E	O	ØA	ØB	ØDint	ØJ
HM 112 T4 18,5kW (A6:3)	1000	16x22,5°	1234	1190	1132	12
HM 112 T4 18,5kW (A6:6)	1000	16x22,5°	1234	1190	1132	12
HM 112 T4 22kW (A6:3)	1000	16x22,5°	1234	1190	1132	12
HM 112 T4 22kW (A6:6)	1000	16x22,5°	1234	1190	1132	12
HM 112 T4 30kW (A6:6)	1000	16x22,5°	1234	1190	1132	12
HM 112 T6 2,2kW (A6:3)	1000	16x22,5°	1234	1190	1132	12
HM 112 T6 2,2kW (A6:6)	1000	16x22,5°	1234	1190	1132	12
HM 112 T6 3kW (A6:3)	1000	16x22,5°	1234	1190	1132	12
HM 112 T6 3kW (A6:6)	1000	16x22,5°	1234	1190	1132	12
HM 112 T6 4kW (A6:3)	1000	16x22,5°	1234	1190	1132	12
HM 112 T6 4kW (A6:6)	1000	16x22,5°	1234	1190	1132	12
HM 112 T6 5,5kW (A6:3)	1000	16x22,5°	1234	1190	1132	12
HM 112 T6 5,5kW (A6:6)	1000	16x22,5°	1234	1190	1132	12
HM 112 T6 7,5kW (A6:6)	1000	16x22,5°	1234	1190	1132	12
HM 112 T6 11kW (A6:6)	1000	16x22,5°	1234	1190	1132	12
HM 112 T4/T6 5,5/1,85kW (A6:3)	1000	16x22,5°	1234	1190	1132	12
HM 112 T4/T6 7,5/2,2kW (A6:3)	1000	16x22,5°	1234	1190	1132	12
HM 112 T4/T6 11/3,6kW (A6:3)	1000	16x22,5°	1234	1190	1132	12
HM 112 T4/T6 11/3,6kW (A6:6)	1000	16x22,5°	1234	1190	1132	12
HM 112 T4/T6 15/4,4kW (A6:3)	1000	16x22,5°	1234	1190	1132	12
HM 112 T4/T6 15/4,4kW (A6:6)	1000	16x22,5°	1234	1190	1132	12
HM 112 T4/T6 18,5/6kW (A6:3)	1000	16x22,5°	1234	1190	1132	12
HM 112 T4/T6 18,5/6kW (A6:6)	1000	16x22,5°	1234	1190	1132	12
HM 112 T4/T6 22/7,5kW (A6:3)	1000	16x22,5°	1234	1190	1132	12
HM 112 T4/T6 22/7,5kW (A6:6)	1000	16x22,5°	1234	1190	1132	12
HM 112 T4/T8 5,5/1,1kW (A6:3)	1000	16x22,5°	1234	1190	1132	12
HM 112 T4/T8 7,5/1,5kW (A6:3)	1000	16x22,5°	1234	1190	1132	12
HM 112 T4/T8 11/3kW (A6:3)	1000	16x22,5°	1234	1190	1132	12
HM 112 T4/T8 11/3kW (A6:6)	1000	16x22,5°	1234	1190	1132	12
HM 112 T4/T8 15/3,5kW (A6:3)	1000	16x22,5°	1234	1190	1132	12
HM 112 T4/T8 15/3,5kW (A6:6)	1000	16x22,5°	1234	1190	1132	12
HM 112 T4/T8 17/4,3kW (A6:3)	1000	16x22,5°	1234	1190	1132	12
HM 112 T4/T8 17/4,3kW (A6:6)	1000	16x22,5°	1234	1190	1132	12
HM 112 T4/T8 20/5kW (A6:3)	1000	16x22,5°	1234	1190	1132	12
HM 112 T4/T8 20/5kW (A6:6)	1000	16x22,5°	1234	1190	1132	12
HM 112 T4/T8 28/6,5kW (A6:6)	1000	16x22,5°	1234	1190	1132	12
HM 112 T4/T8 35/8kW (A6:6)	1000	16x22,5°	1234	1190	1132	12
HM 125 T4 11kW (A7:4)	1000	20x18°	1365	1320	1263	15
HM 125 T4 15kW (A7:4)	1000	20x18°	1365	1320	1263	15
HM 125 T4 15kW (A7:8)	1000	20x18°	1365	1320	1263	15

Model	E	O	ØA	ØB	ØDint	ØJ
HM 125 T4 18,5kW (A7:4)	1000	20x18°	1365	1320	1263	15
HM 125 T4 18,5kW (A7:8)	1000	20x18°	1365	1320	1263	15
HM 125 T4 22kW (A7:4)	1000	20x18°	1365	1320	1263	15
HM 125 T4 22kW (A7:8)	1000	20x18°	1365	1320	1263	15
HM 125 T4 30kW (A7:4)	1000	20x18°	1365	1320	1263	15
HM 125 T4 30kW (A7:8)	1000	20x18°	1365	1320	1263	15
HM 125 T4 37kW (A7:4)	1000	20x18°	1365	1320	1263	15
HM 125 T4 37kW (A7:8)	1000	20x18°	1365	1320	1263	15
HM 125 T4 45kW (A7:8)	1000	20x18°	1365	1320	1263	15
HM 125 T6 3kW (A7:4)	1000	20x18°	1365	1320	1263	15
HM 125 T6 4kW (A7:4)	1000	20x18°	1365	1320	1263	15
HM 125 T6 5,5kW (A7:4)	1000	20x18°	1365	1320	1263	15
HM 125 T6 5,5kW (A7:8)	1000	20x18°	1365	1320	1263	15
HM 125 T6 7,5kW (A7:4)	1000	20x18°	1365	1320	1263	15
HM 125 T6 7,5kW (A7:8)	1000	20x18°	1365	1320	1263	15
HM 125 T6 11kW (A7:4)	1000	20x18°	1365	1320	1263	15
HM 125 T6 11kW (A7:8)	1000	20x18°	1365	1320	1263	15
HM 125 T6 15kW (A7:8)	1000	20x18°	1365	1320	1263	15
HM 125 T4/T6 11/3,6kW (A7:4)	1000	20x18°	1365	1320	1263	15
HM 125 T4/T6 15/4,4kW (A7:4)	1000	20x18°	1365	1320	1263	15
HM 125 T4/T6 15/4,4kW (A7:8)	1000	20x18°	1365	1320	1263	15
HM 125 T4/T6 18,5/6kW (A7:4)	1000	20x18°	1365	1320	1263	15
HM 125 T4/T6 18,5/6kW (A7:8)	1000	20x18°	1365	1320	1263	15
HM 125 T4/T6 22/7,5kW (A7:4)	1000	20x18°	1365	1320	1263	15
HM 125 T4/T6 22/7,5kW (A7:8)	1000	20x18°	1365	1320	1263	15
HM 125 T4/T8 11/3kW (A7:4)	1000	20x18°	1365	1320	1263	15
HM 125 T4/T8 15/3,5kW (A7:4)	1000	20x18°	1365	1320	1263	15
HM 125 T4/T8 15/3,5kW (A7:8)	1000	20x18°	1365	1320	1263	15
HM 125 T4/T8 17/4,3kW (A7:4)	1000	20x18°	1365	1320	1263	15
HM 125 T4/T8 20/5kW (A7:4)	1000	20x18°	1365	1320	1263	15
HM 125 T4/T8 20/5kW (A7:8)	1000	20x18°	1365	1320	1263	15
HM 125 T4/T8 28/6,5kW (A7:4)	1000	20x18°	1365	1320	1263	15
HM 125 T4/T8 28/6,5kW (A7:8)	1000	20x18°	1365	1320	1263	15
HM 125 T4/T8 35/8kW (A7:4)	1000	20x18°	1365	1320	1263	15
HM 125 T4/T8 35/8kW (A7:8)	1000	20x18°	1365	1320	1263	15
HM 125 T4/T8 37/9,2kW (A7:8)	1000	20x18°	1365	1320	1263	15
HM 125 T4/T8 44/11kW (A7:8)	1000	20x18°	1365	1320	1263	15

# Wiring diagram

DIAGRAM Nº 1

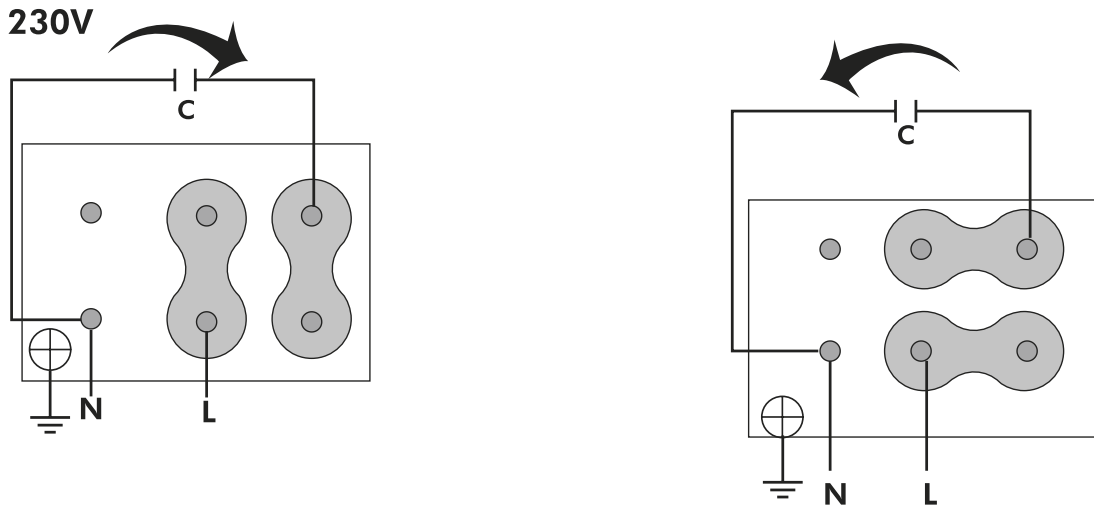

DIAGRAM Nº 2

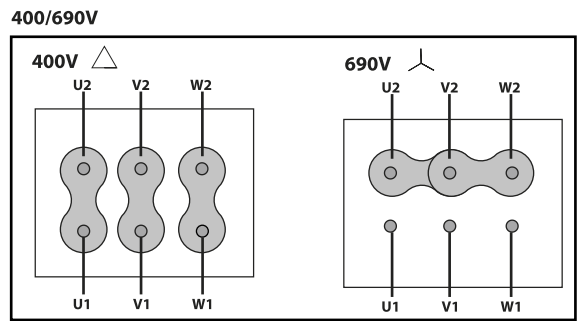
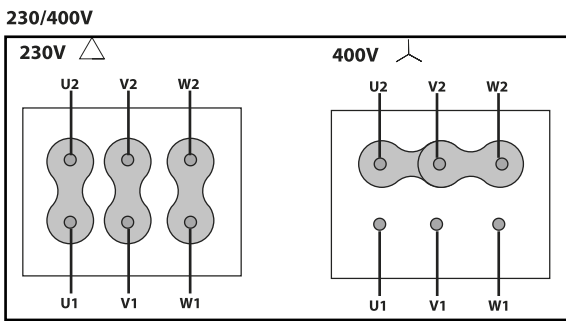

DIAGRAM Nº 3

400V DAHLANDER (Y,YY)

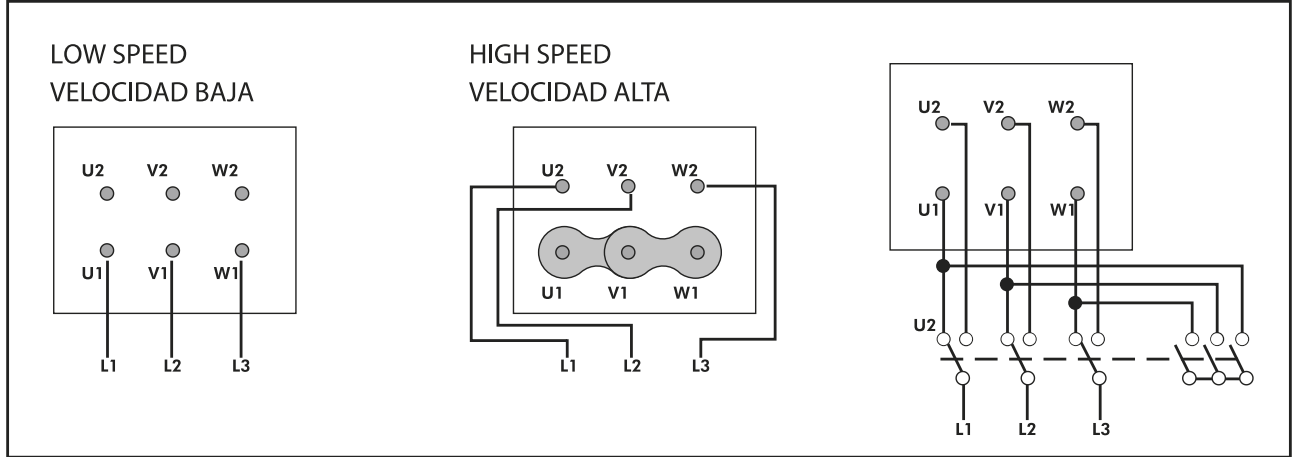
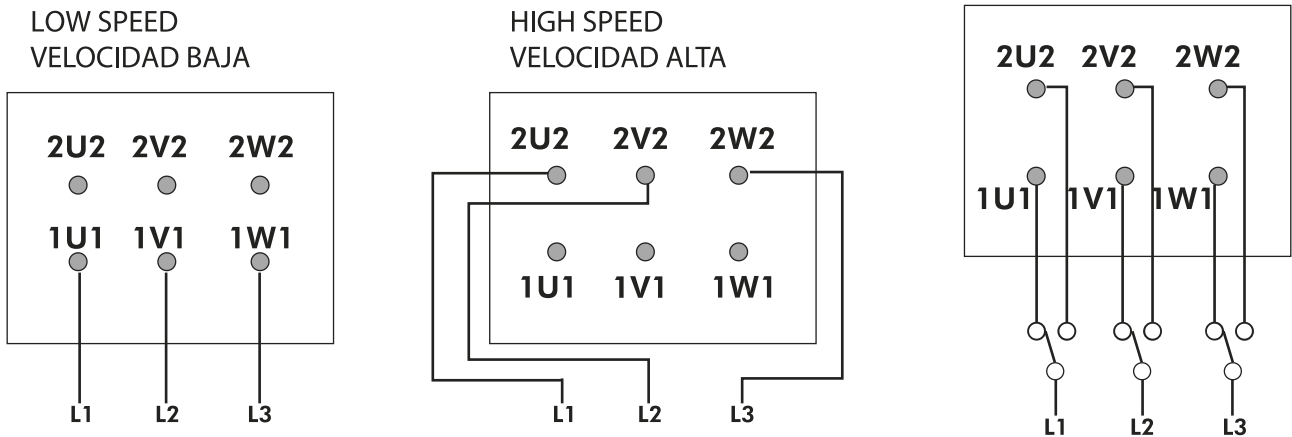

DIAGRAM Nº 4



# CHARACTERISCTIC CURVE

HM 35 M2 0,55kW (A0:6)

HM 35 M2 1,1kW (A0:6)

## AIR FLOW - PRESSURE

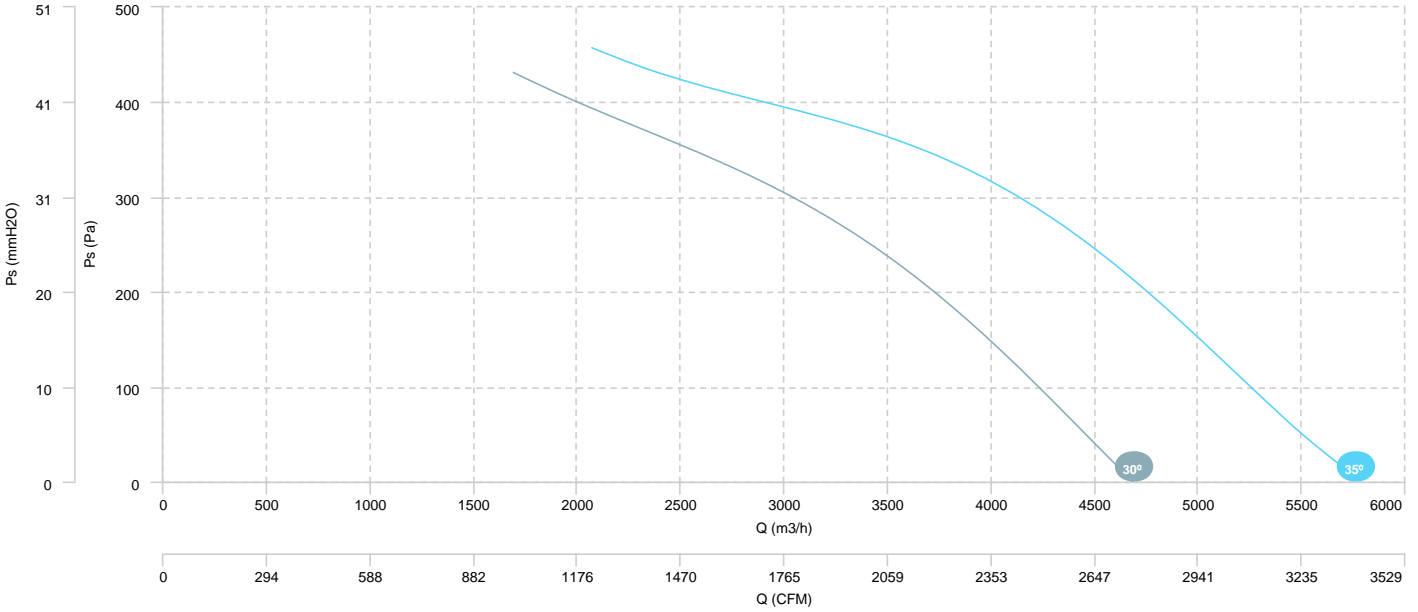

## AIR FLOW - ABSORBED POWER

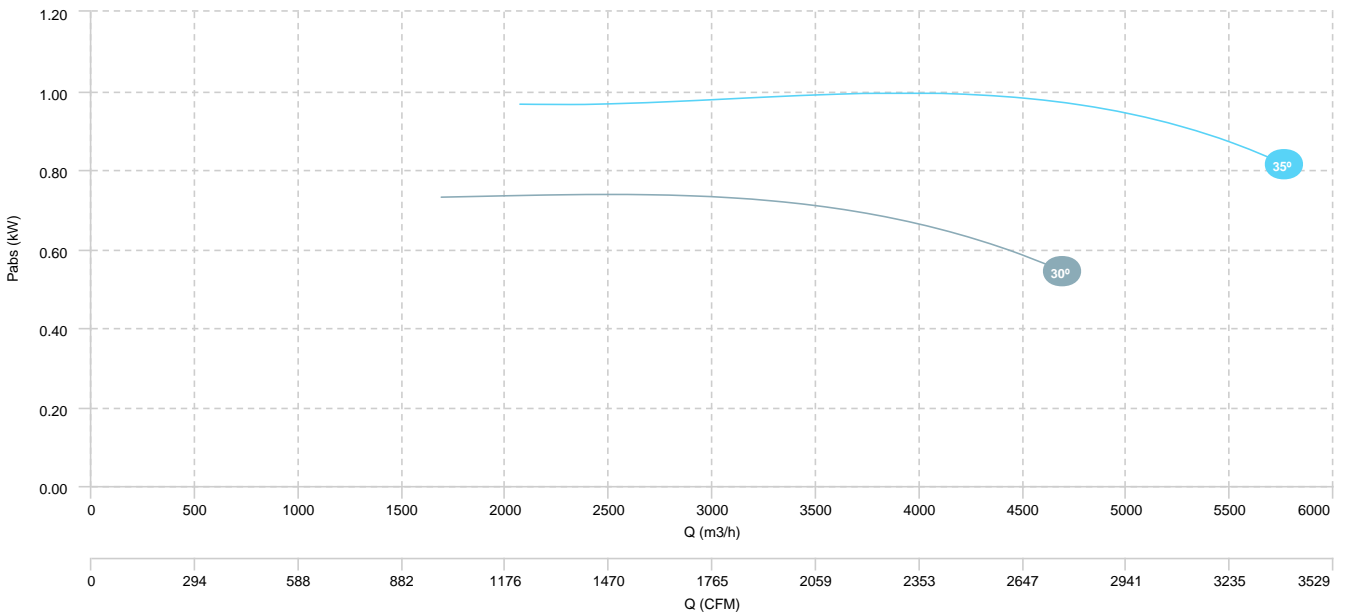

HM 35 M4 0,12kW (A0:6)

AIR FLOW - PRESSURE

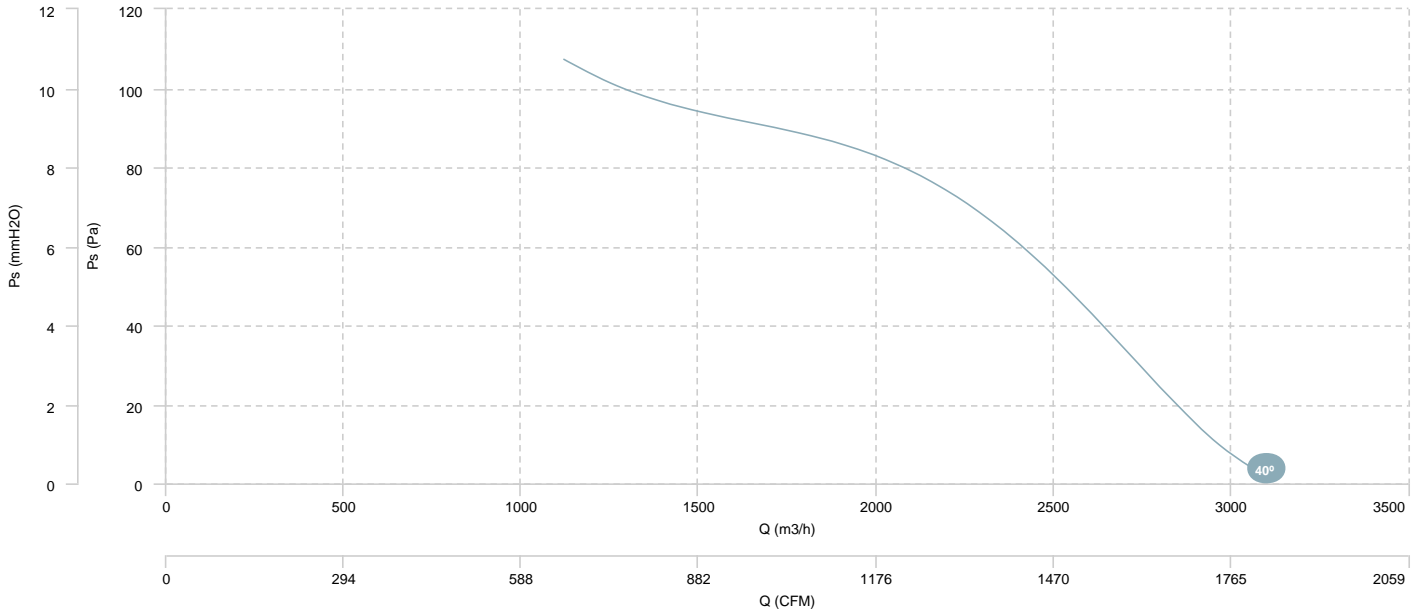

AIR FLOW - ABSORBED POWER

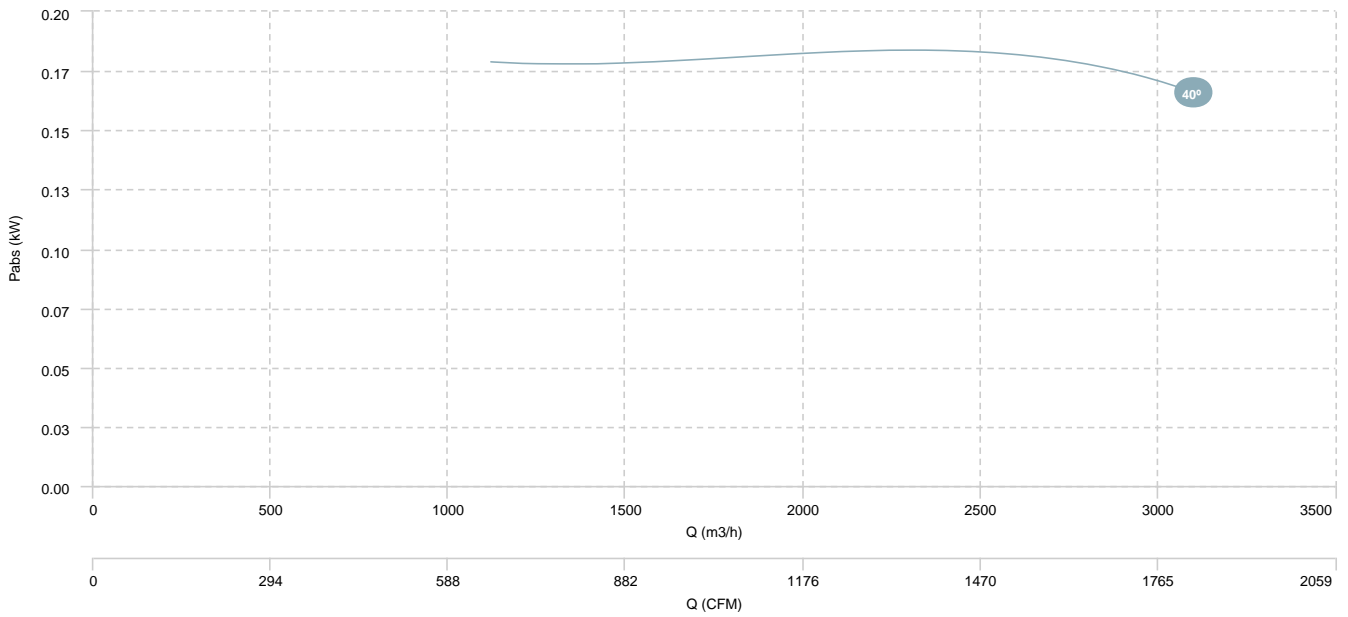

HM 40 M4 0,25kW (A0:6)

AIR FLOW - PRESSURE

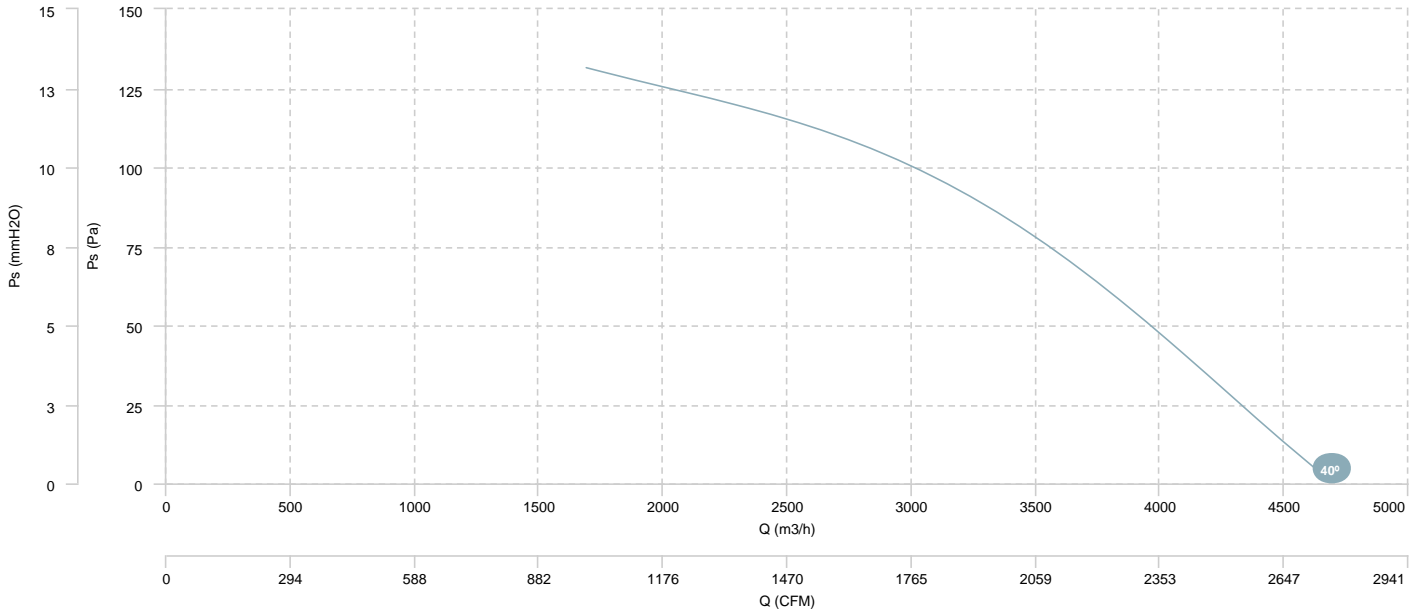

AIR FLOW - ABSORBED POWER

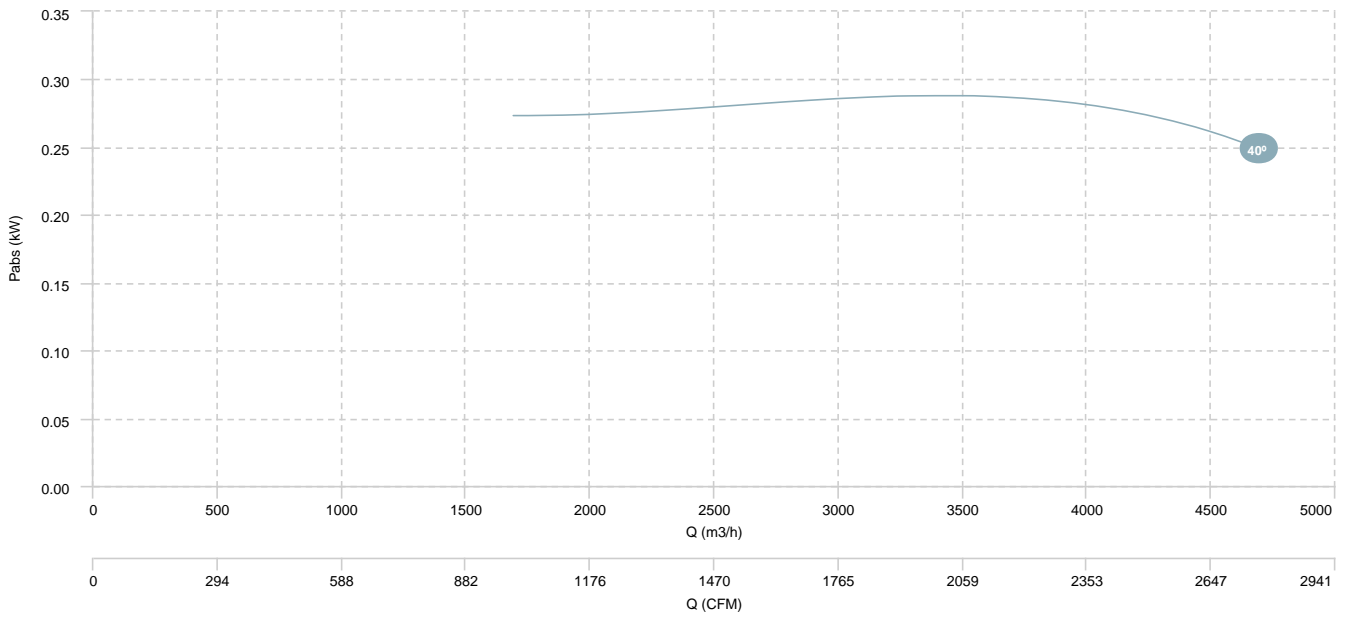



HM 40 M6 0,04kW (A0:6)

AIR FLOW - PRESSURE

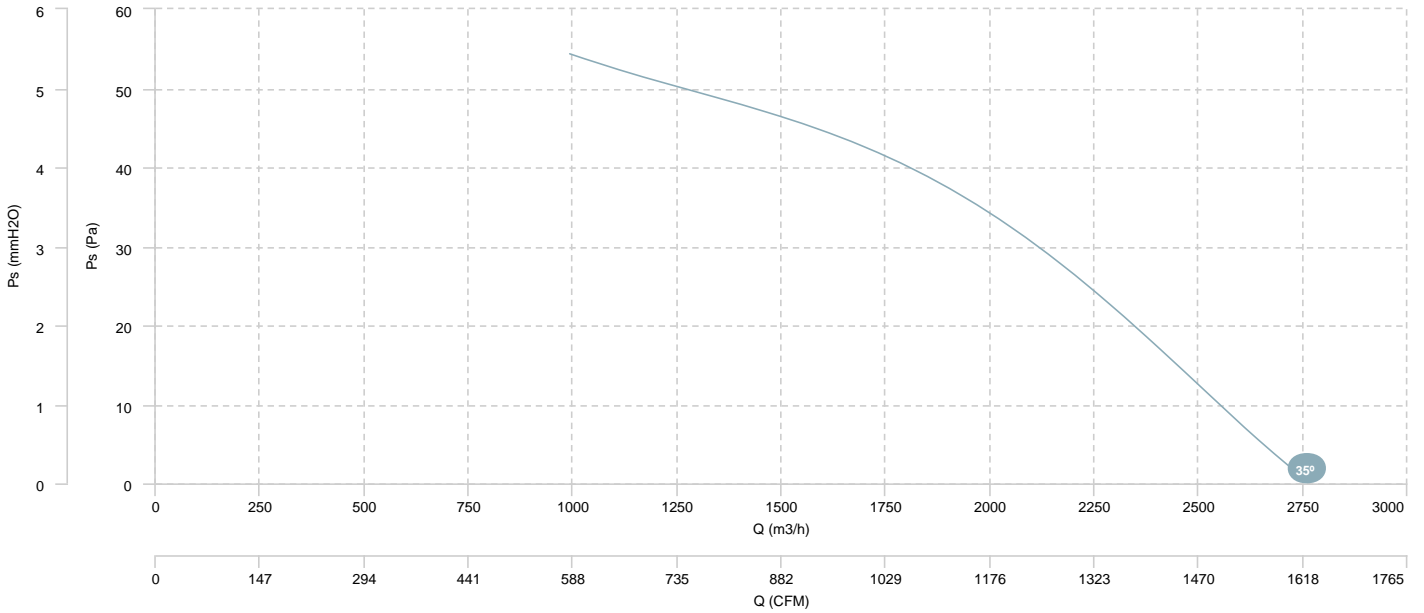

AIR FLOW - ABSORBED POWER

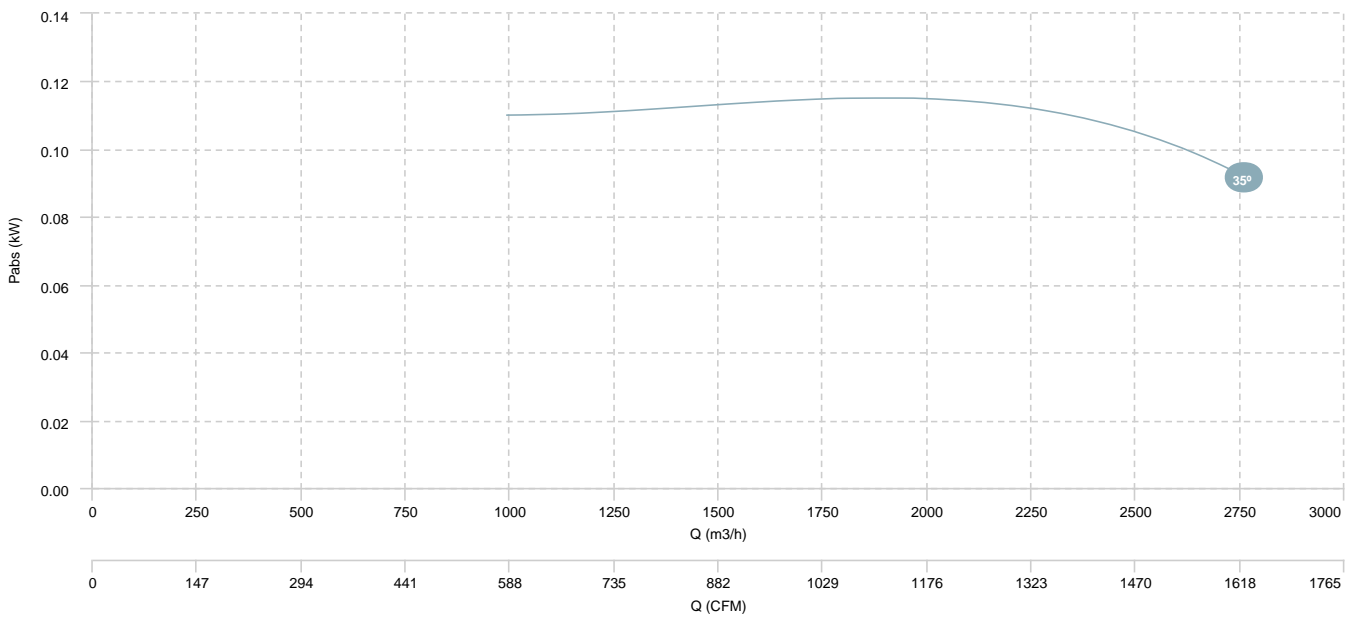

HM 45 M4 0,37kW (A0:6)

AIR FLOW - PRESSURE

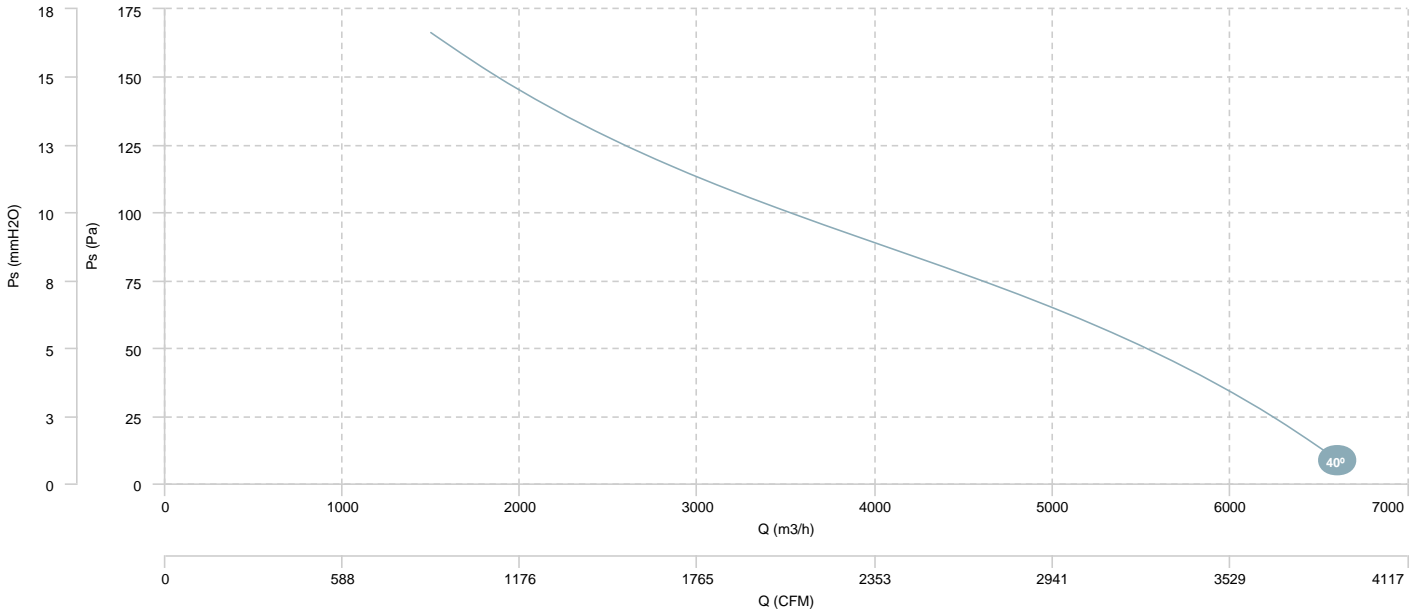

AIR FLOW - ABSORBED POWER

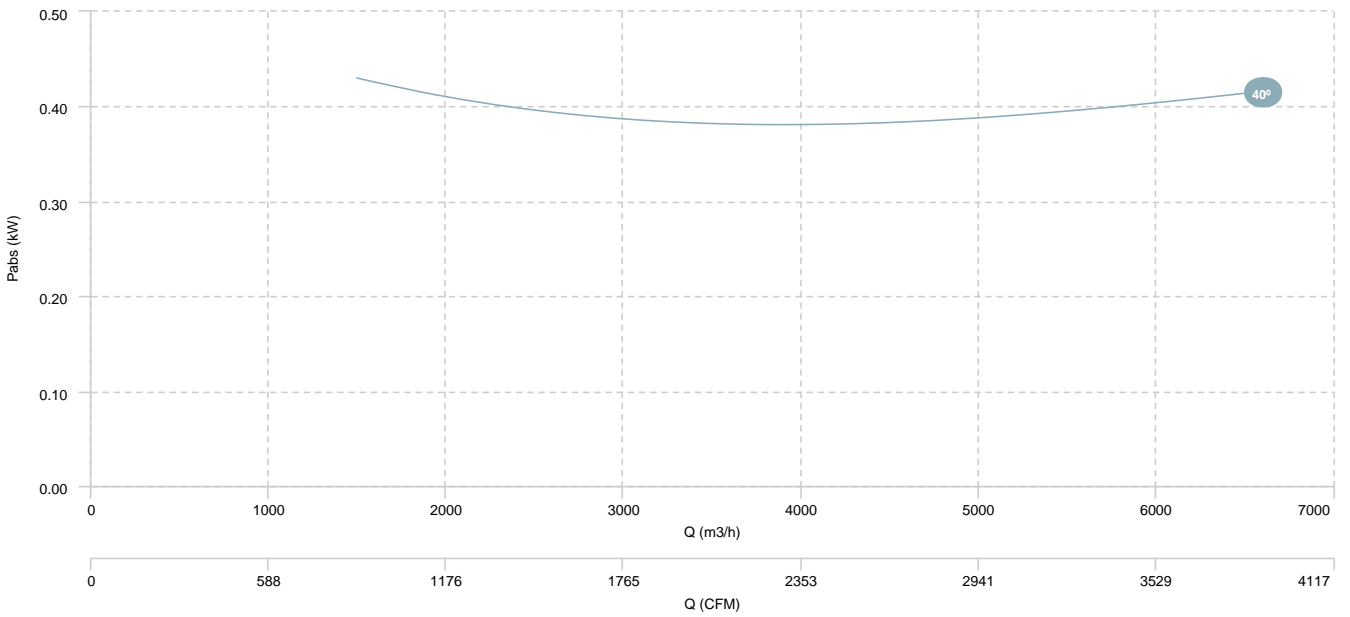

HM 45 M6 0,13kW (A0:6)

AIR FLOW - PRESSURE

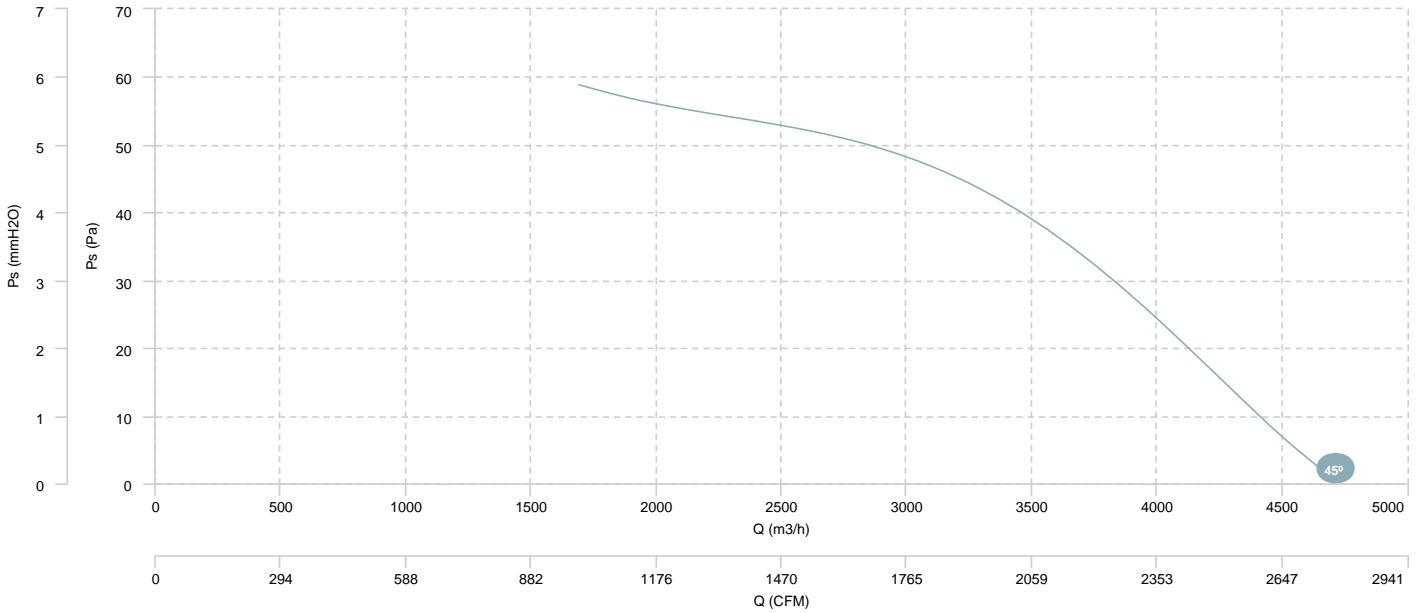

AIR FLOW - ABSORBED POWER

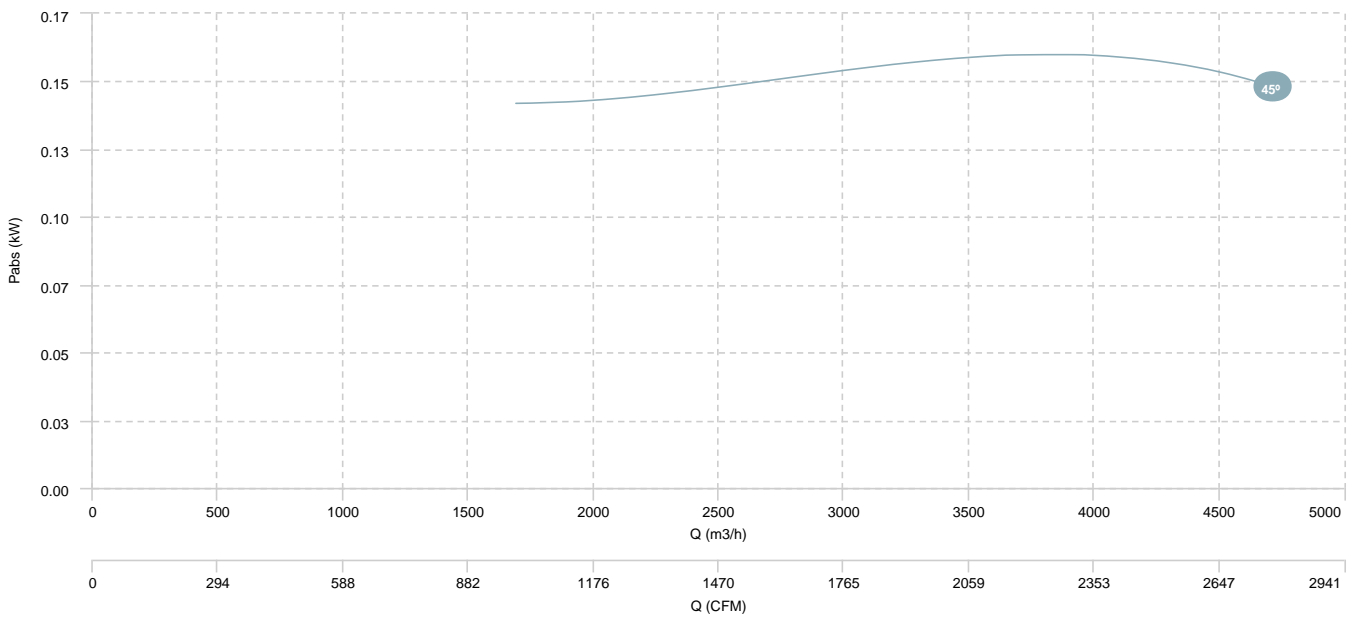

HM 50 M4 0,55kW (A0:6)

AIR FLOW - PRESSURE

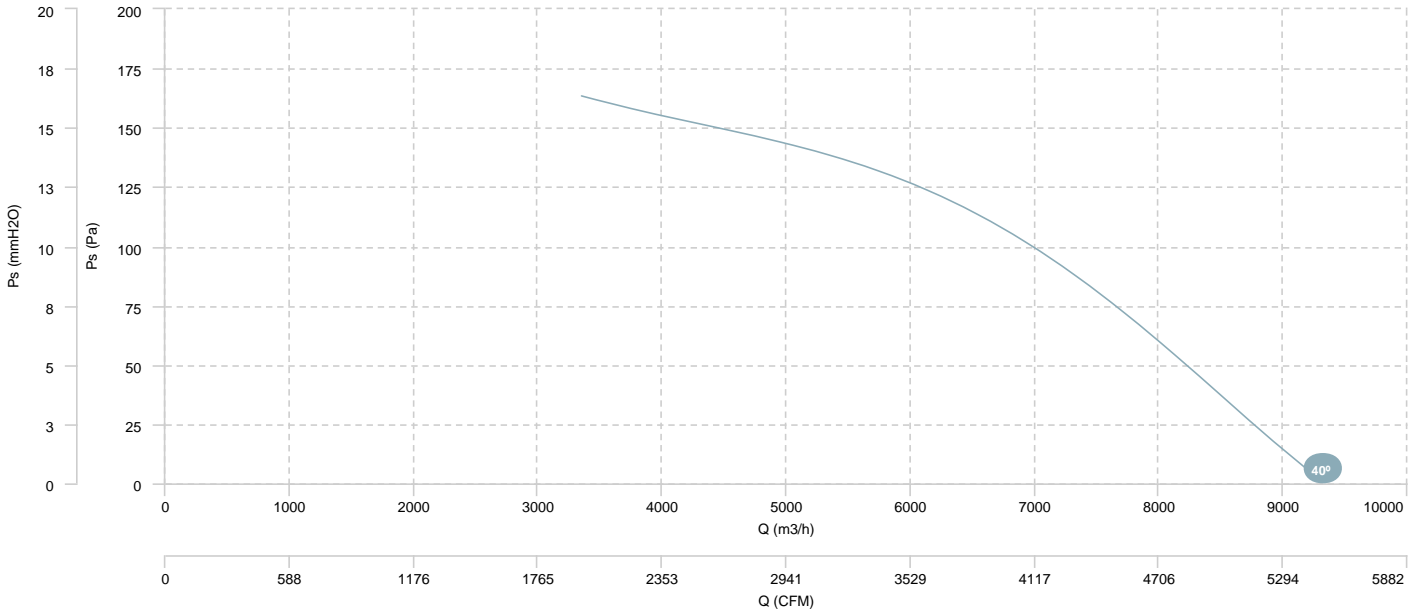

AIR FLOW - ABSORBED POWER

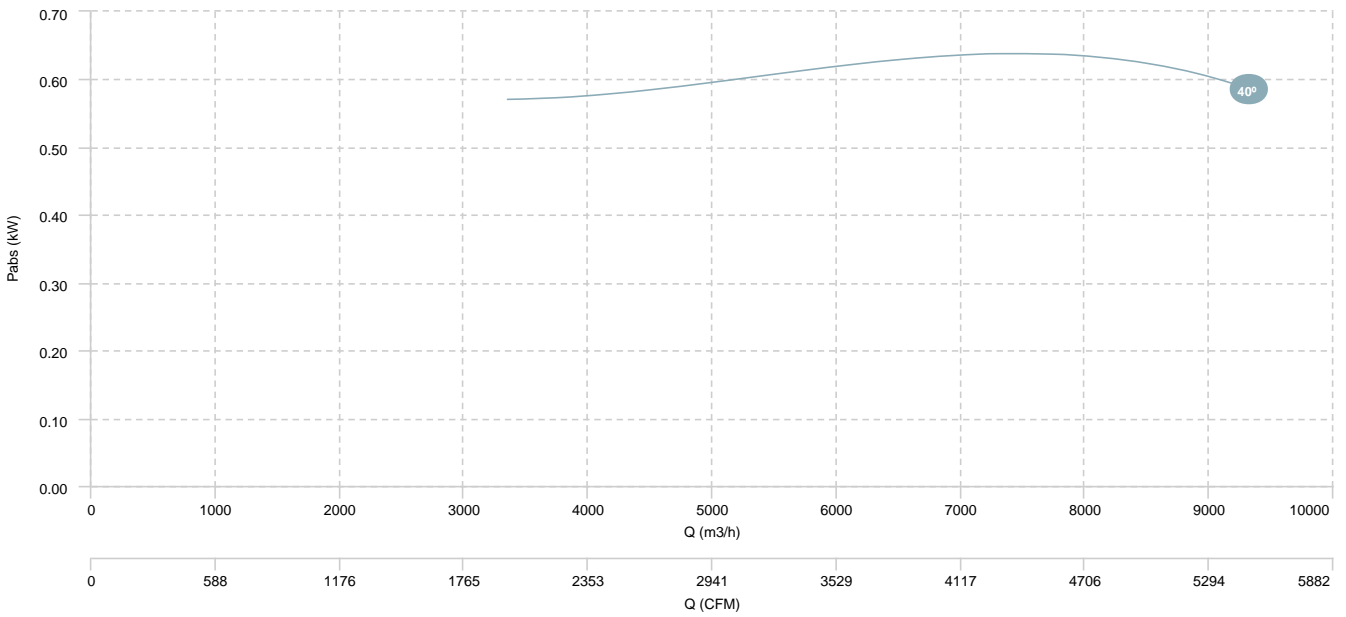

HM 50 M6 0,13kW (A0:6)

AIR FLOW - PRESSURE

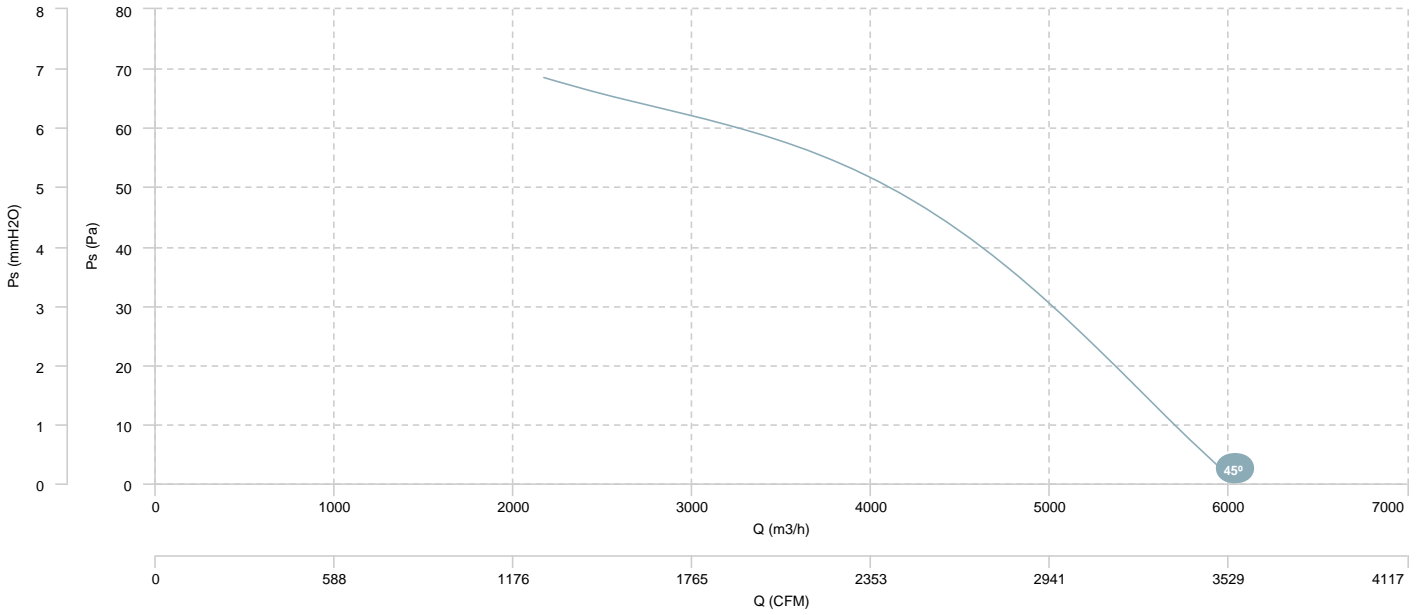

AIR FLOW - ABSORBED POWER

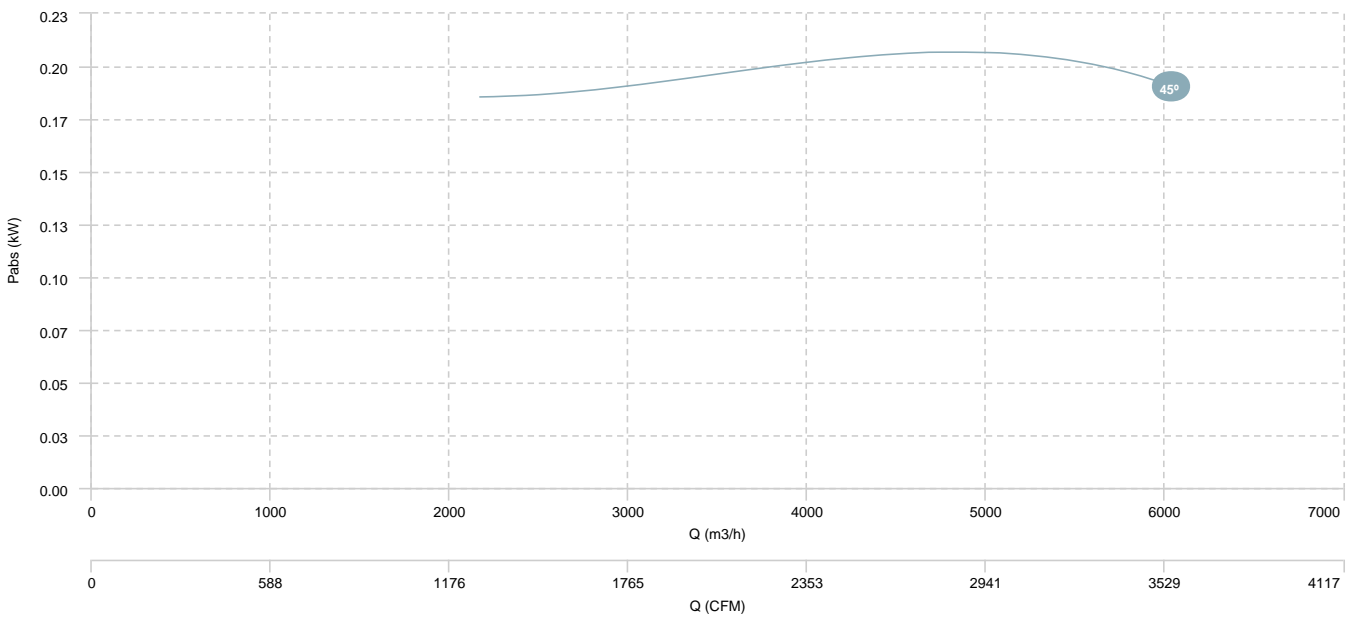

HM 56 M4 0,37kW (A5:6)

HM 56 M4 0,55kW (A5:6)

AIR FLOW - PRESSURE

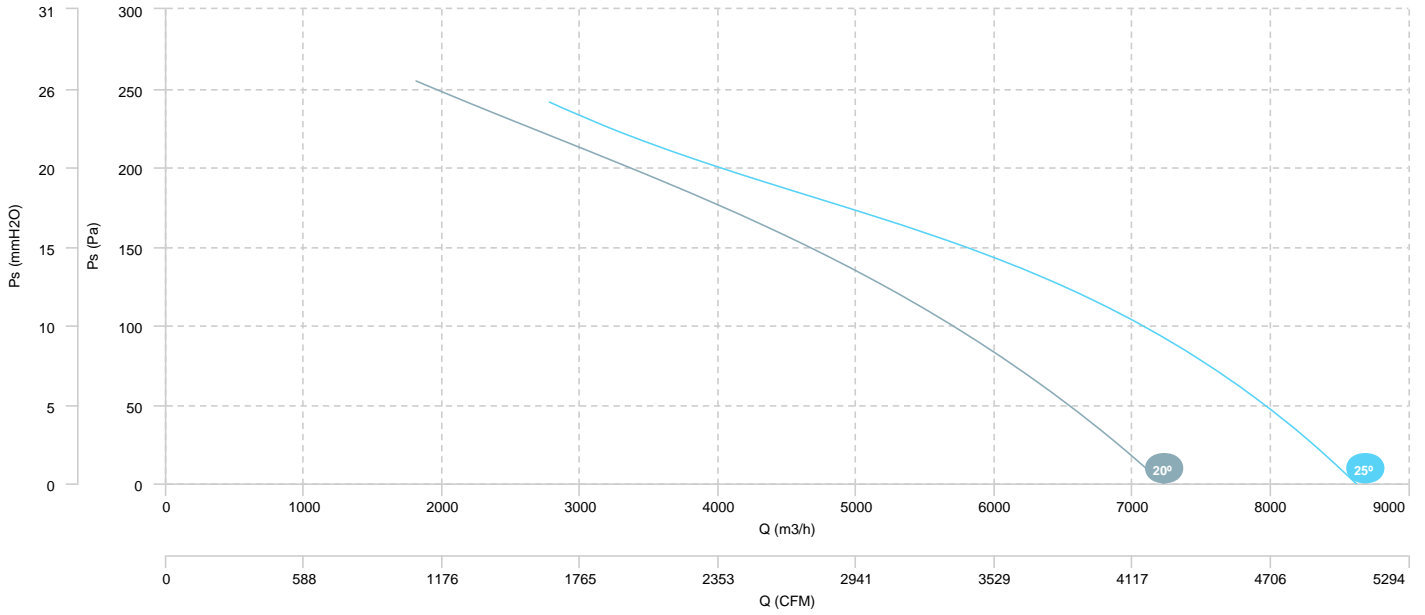

AIR FLOW - ABSORBED POWER

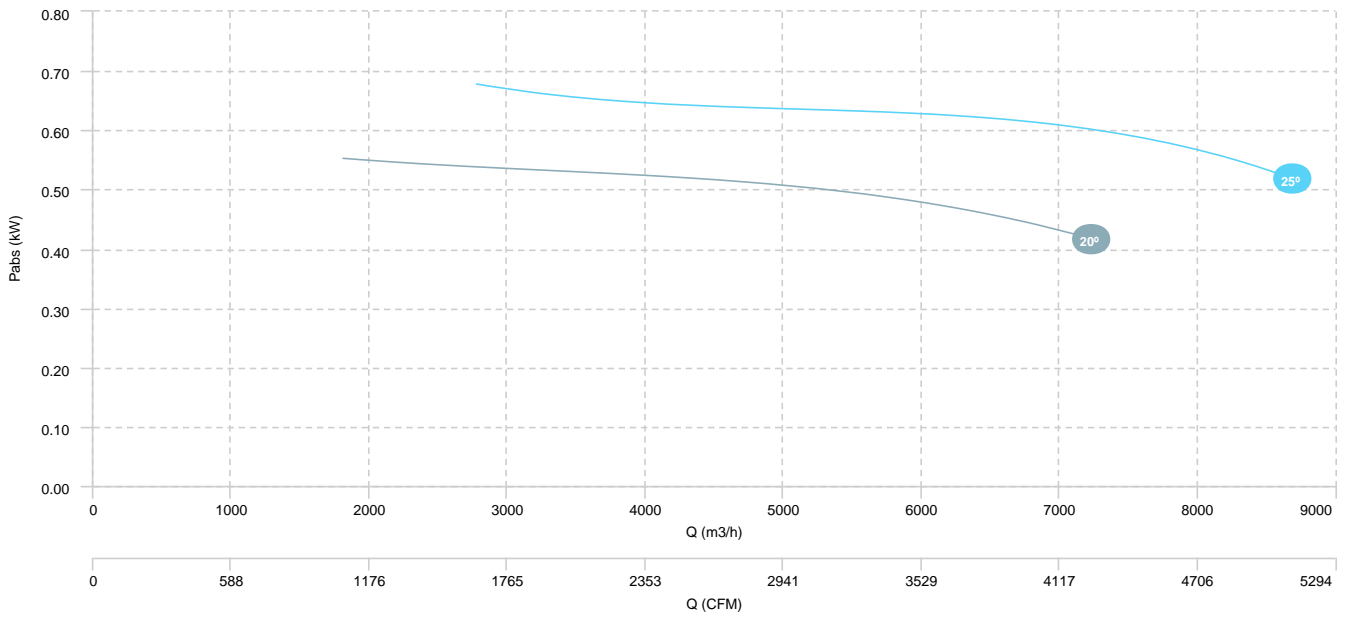

HM 56 M4 0,55kW (A2:6)

AIR FLOW - PRESSURE

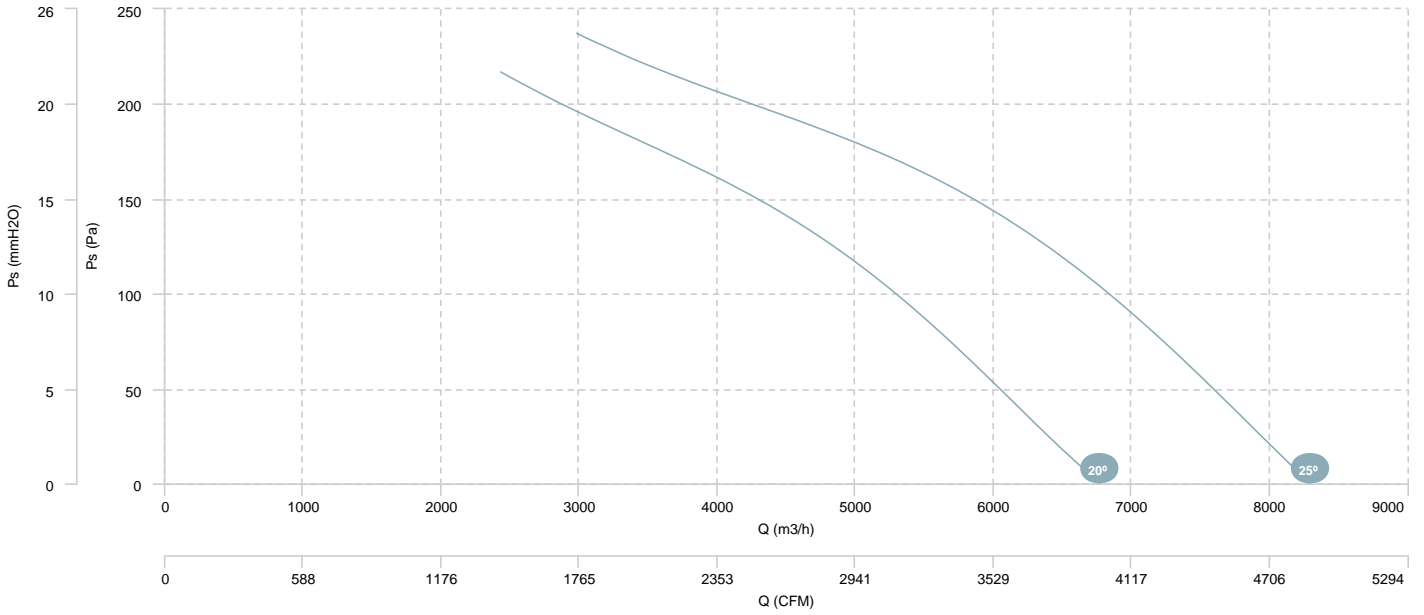

AIR FLOW - ABSORBED POWER

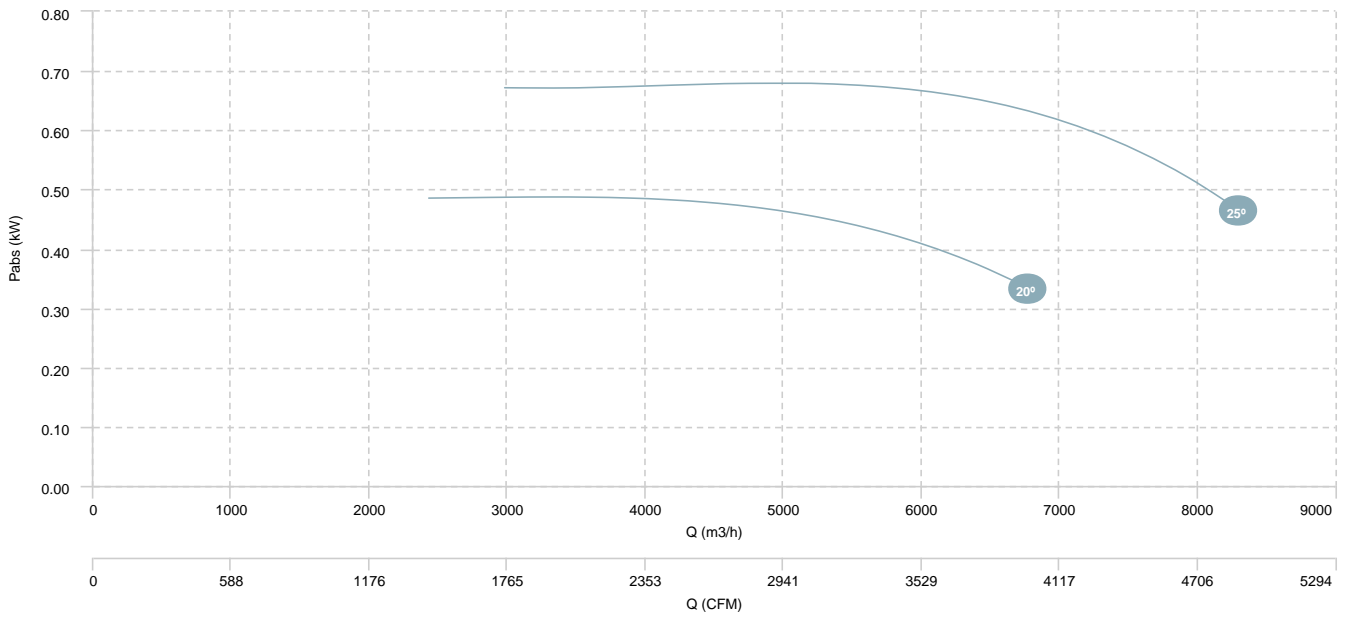

HM 56 M6 0,25kW (A5:6)

HM 56 M6 0,37kW (A5:6)

AIR FLOW - PRESSURE

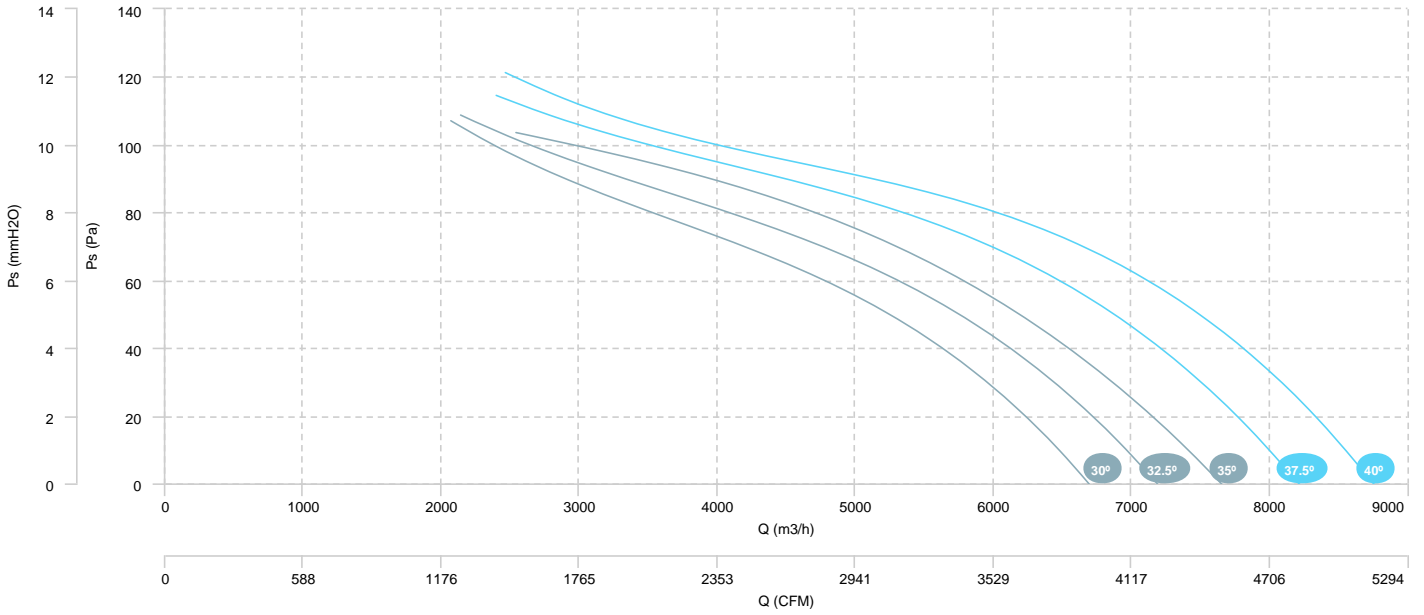

AIR FLOW - ABSORBED POWER

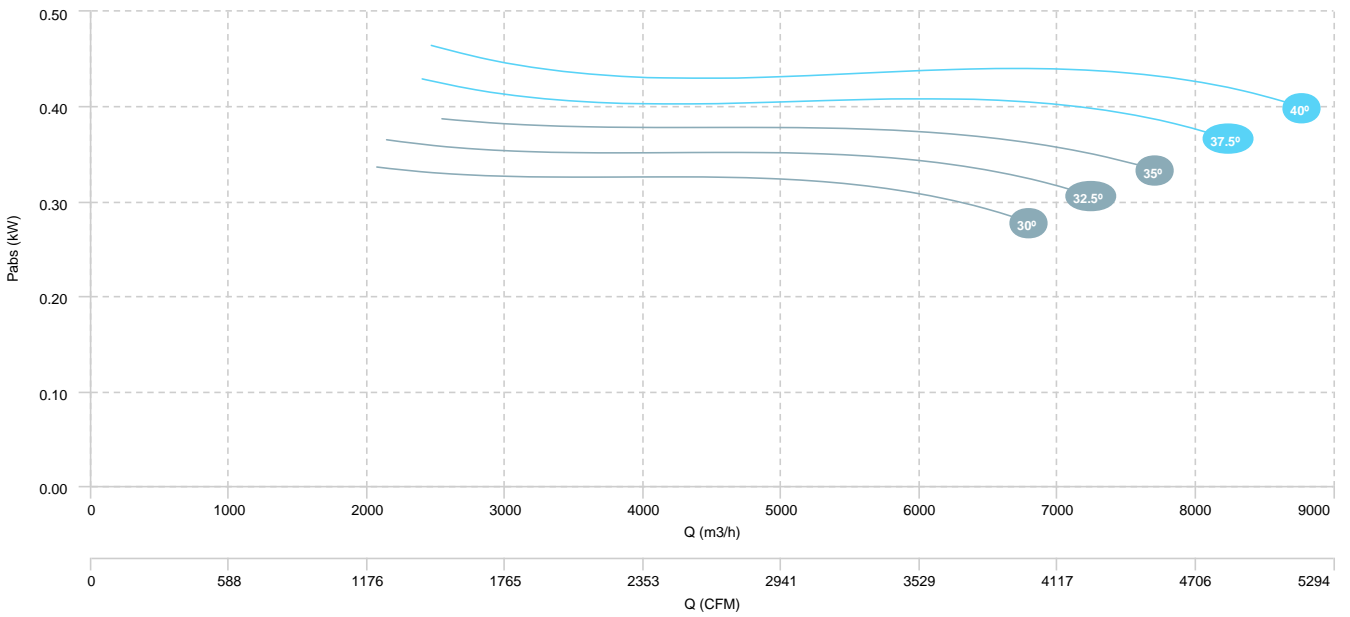



HM 56 M6 0,25kW (A2:6)

HM 56 M6 0,37kW (A2:6)

AIR FLOW - PRESSURE

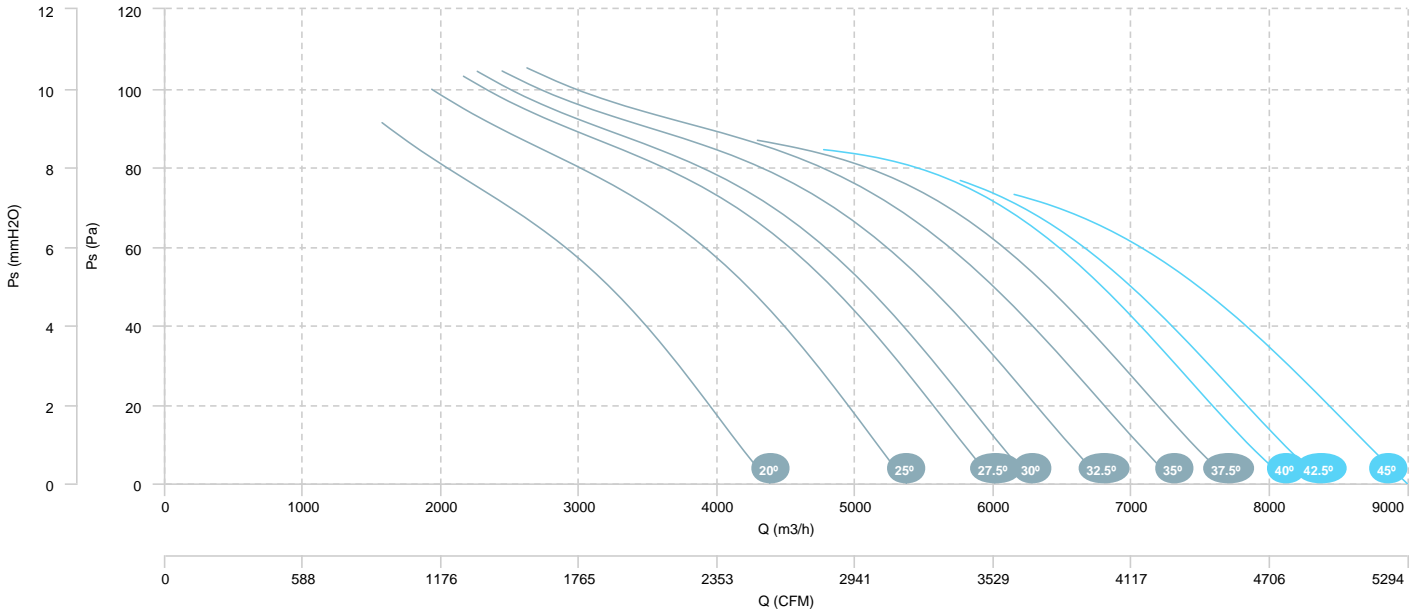

AIR FLOW - ABSORBED POWER

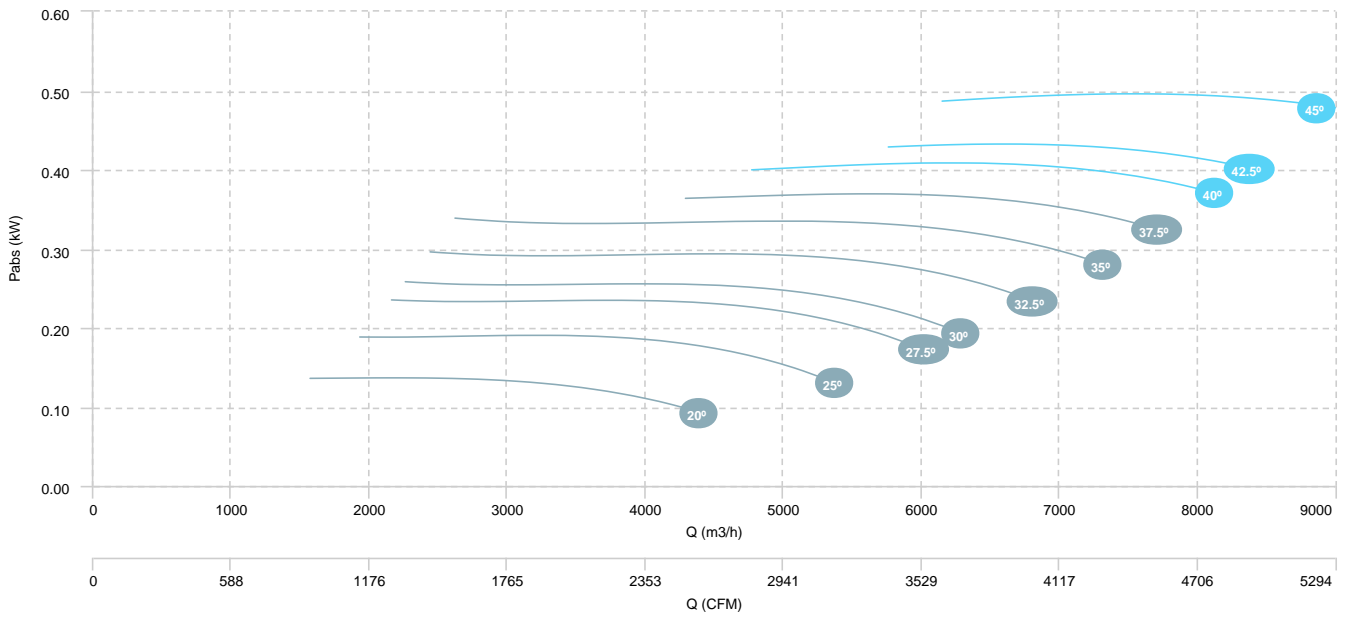

HM 63 M6 0,55kW (A2:9)

AIR FLOW - PRESSURE

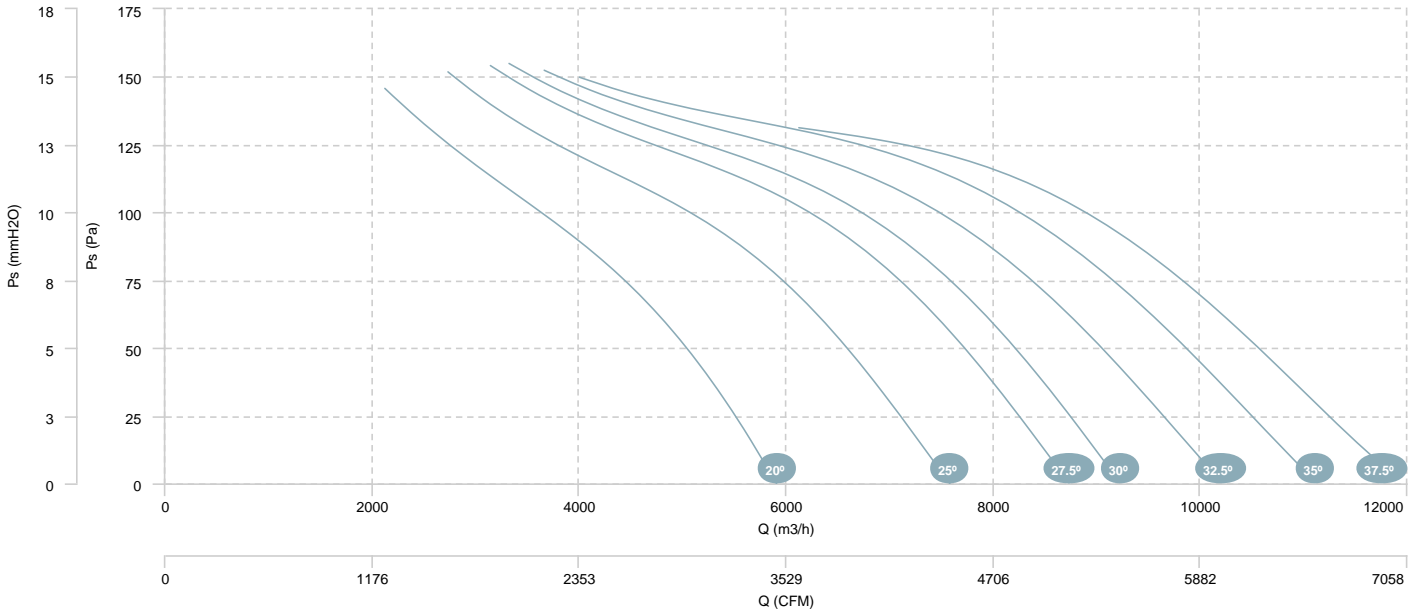

AIR FLOW - ABSORBED POWER

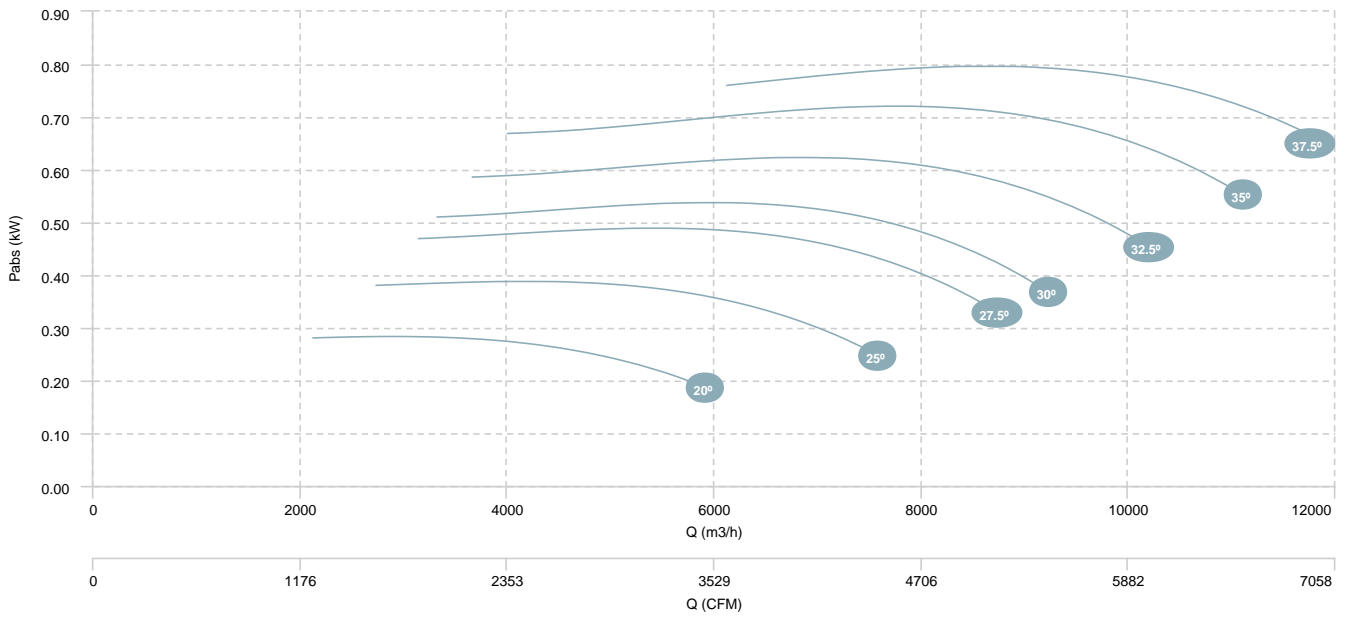

HM 63 M6 0,37kW (A5:6)

HM 63 M6 0,55kW (A5:6)

AIR FLOW - PRESSURE

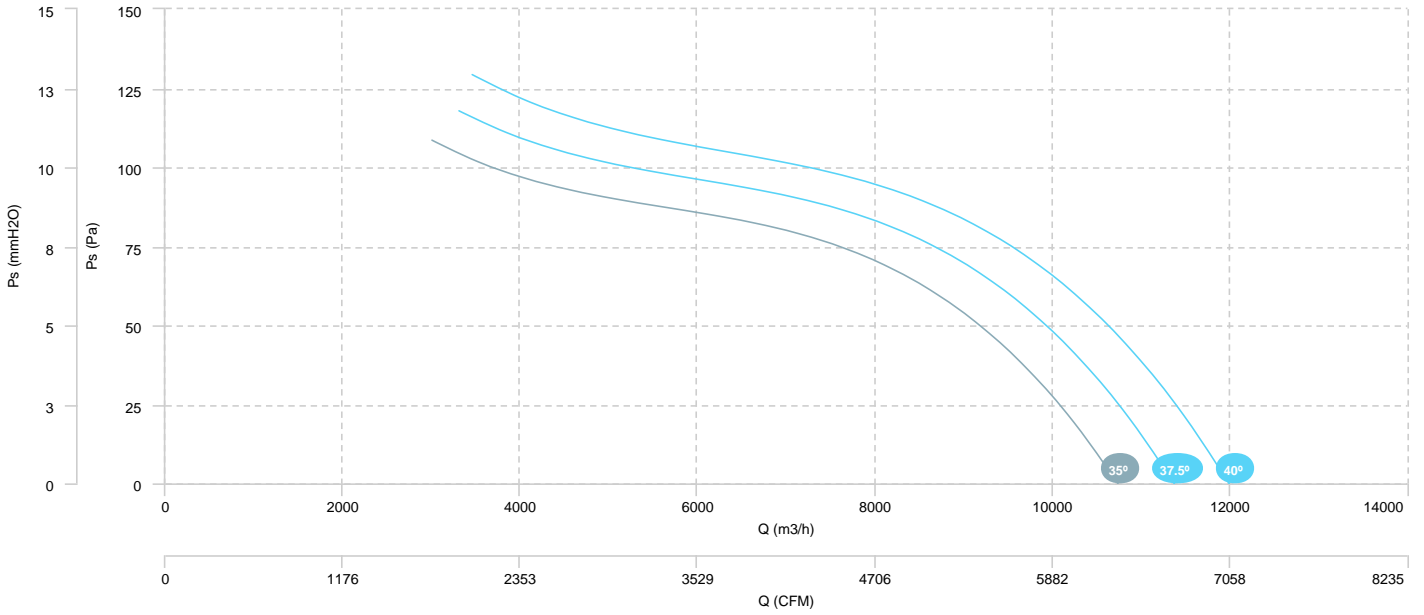

AIR FLOW - ABSORBED POWER

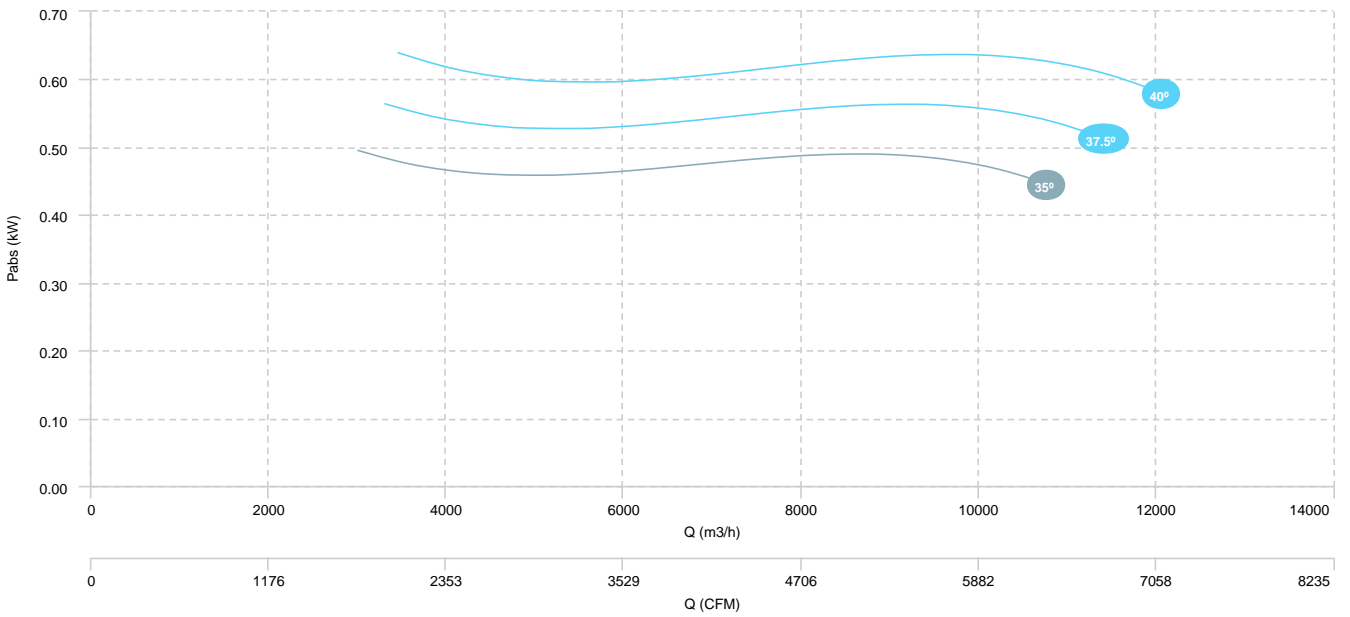

HM 71 M6 0,55kW (A2:6)

AIR FLOW - PRESSURE

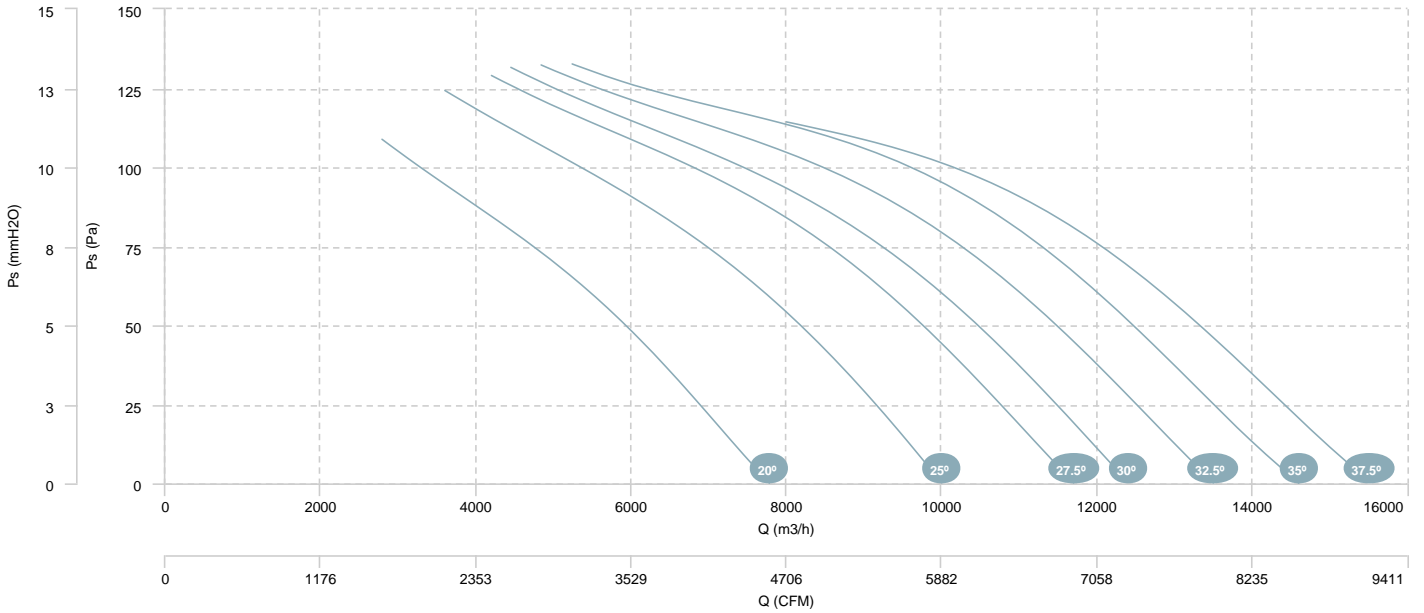

AIR FLOW - ABSORBED POWER

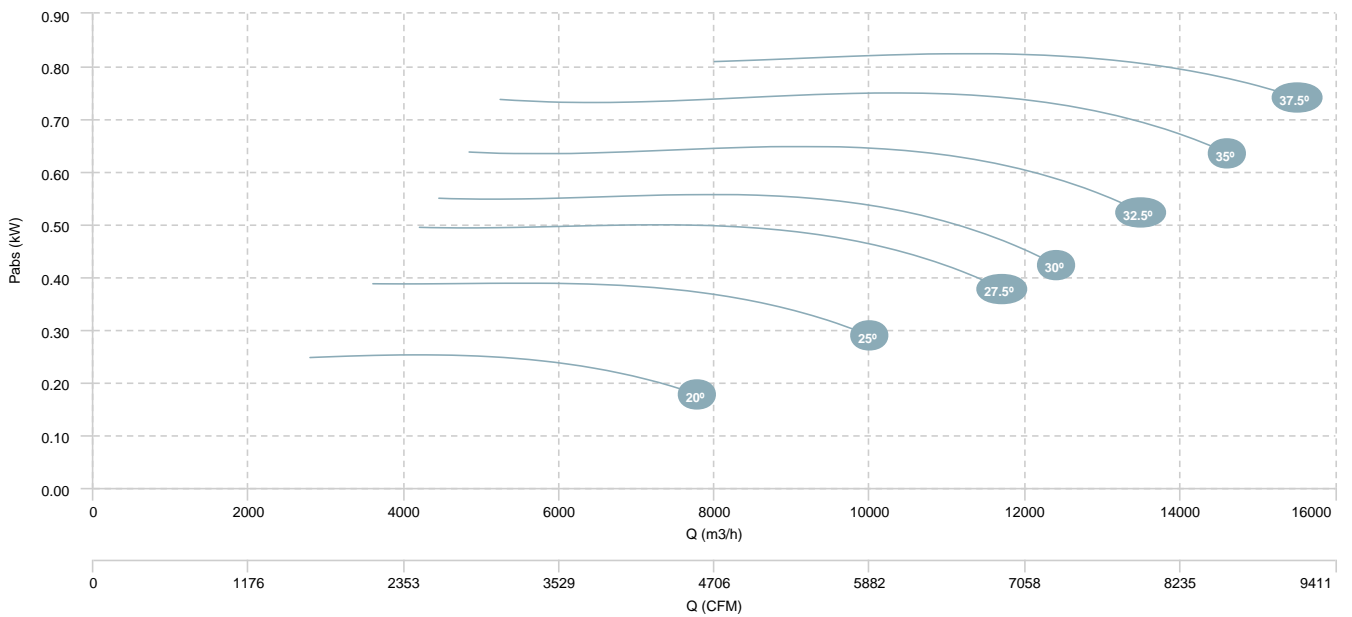

HM 71 M6 0,55kW (A2:9)

AIR FLOW - PRESSURE

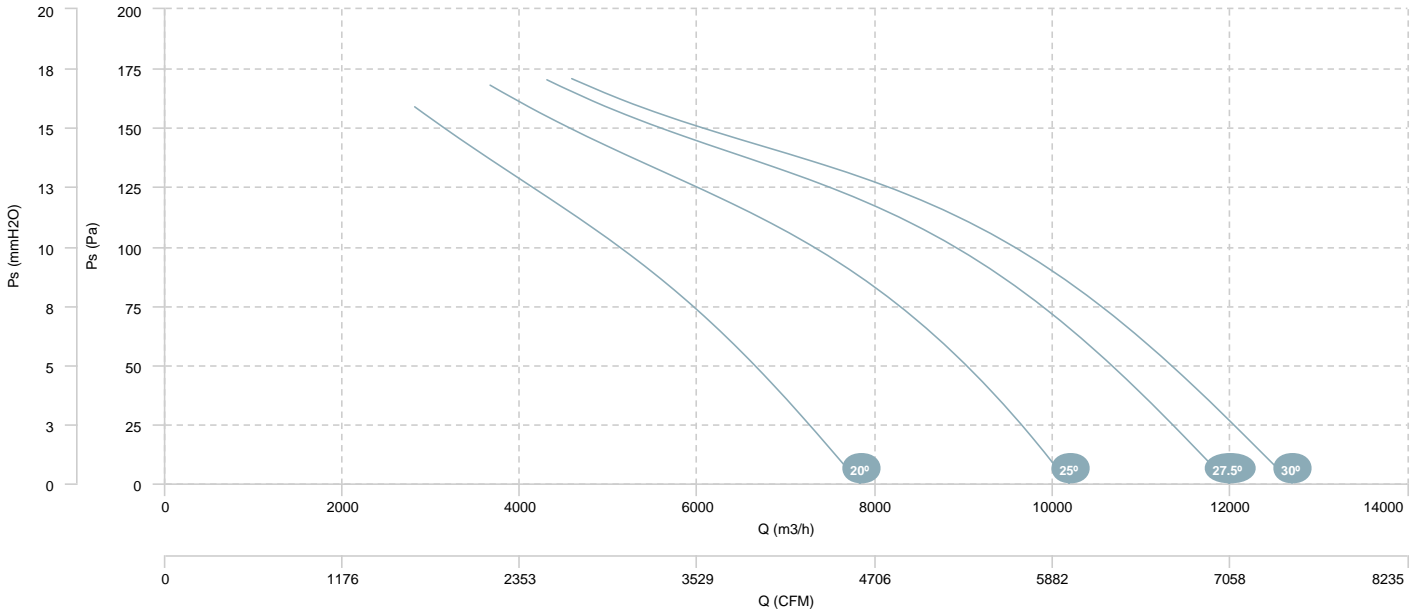

AIR FLOW - ABSORBED POWER

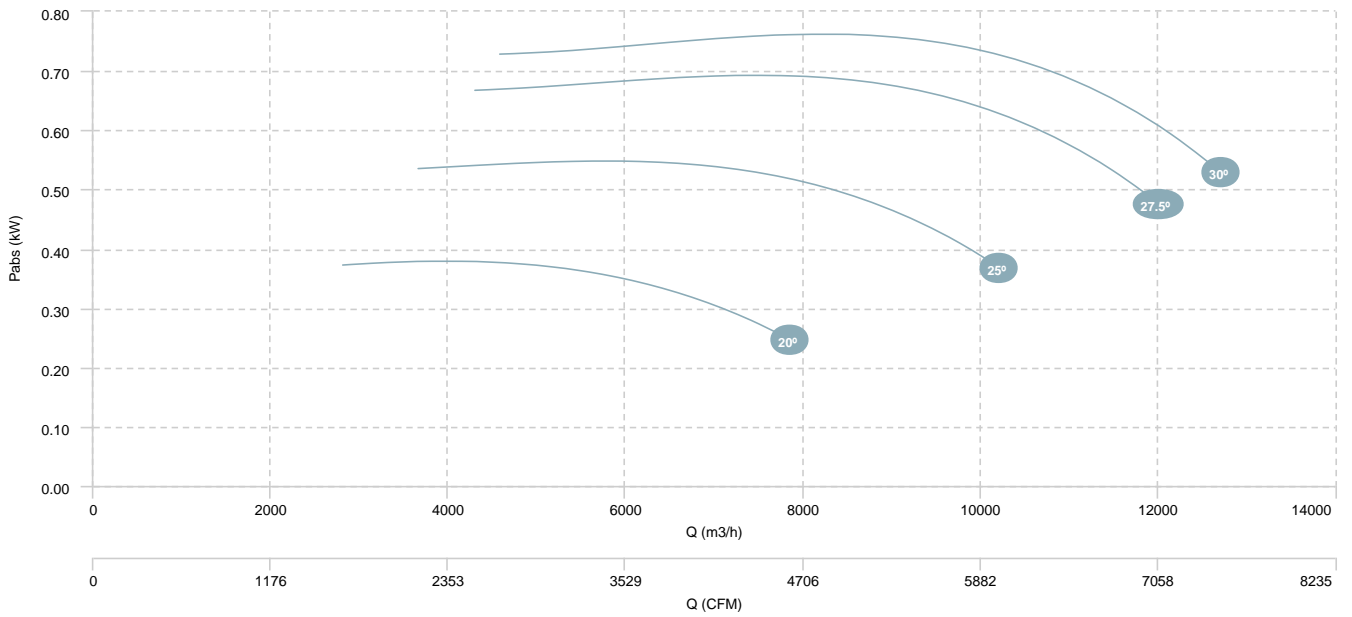

HM 35 T2 0,55kW (A0:6)

HM 35 T2 1,1kW (A0:6)

AIR FLOW - PRESSURE

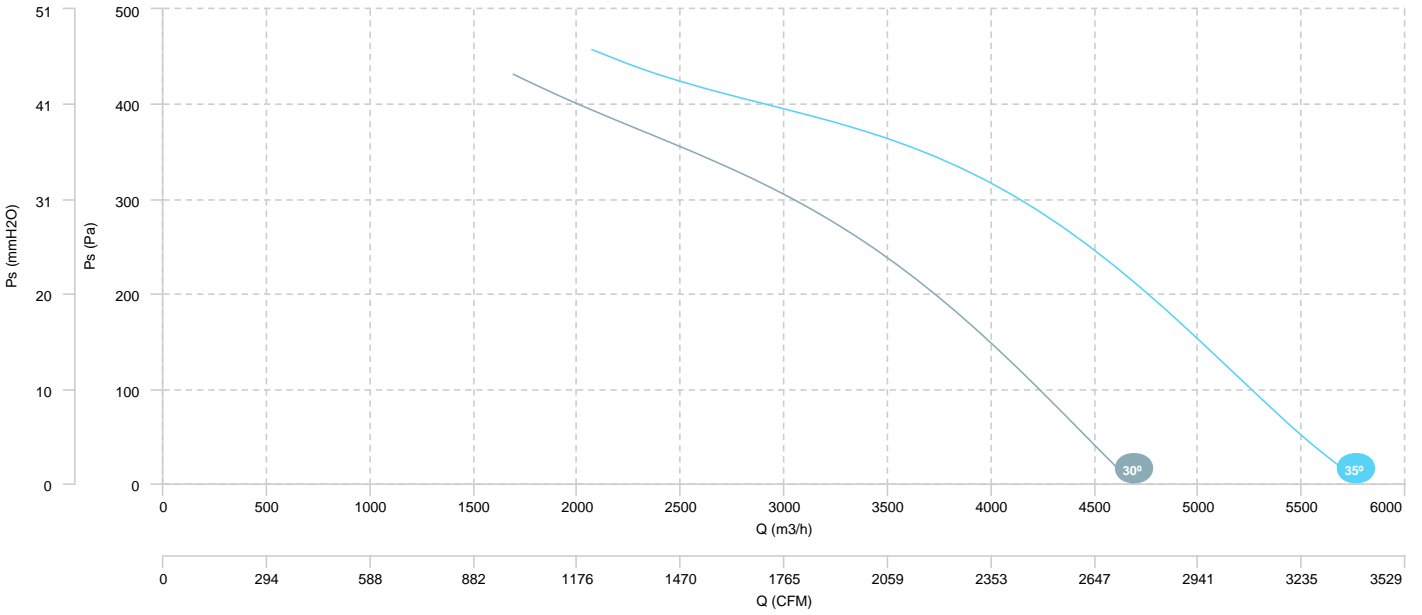

AIR FLOW - ABSORBED POWER

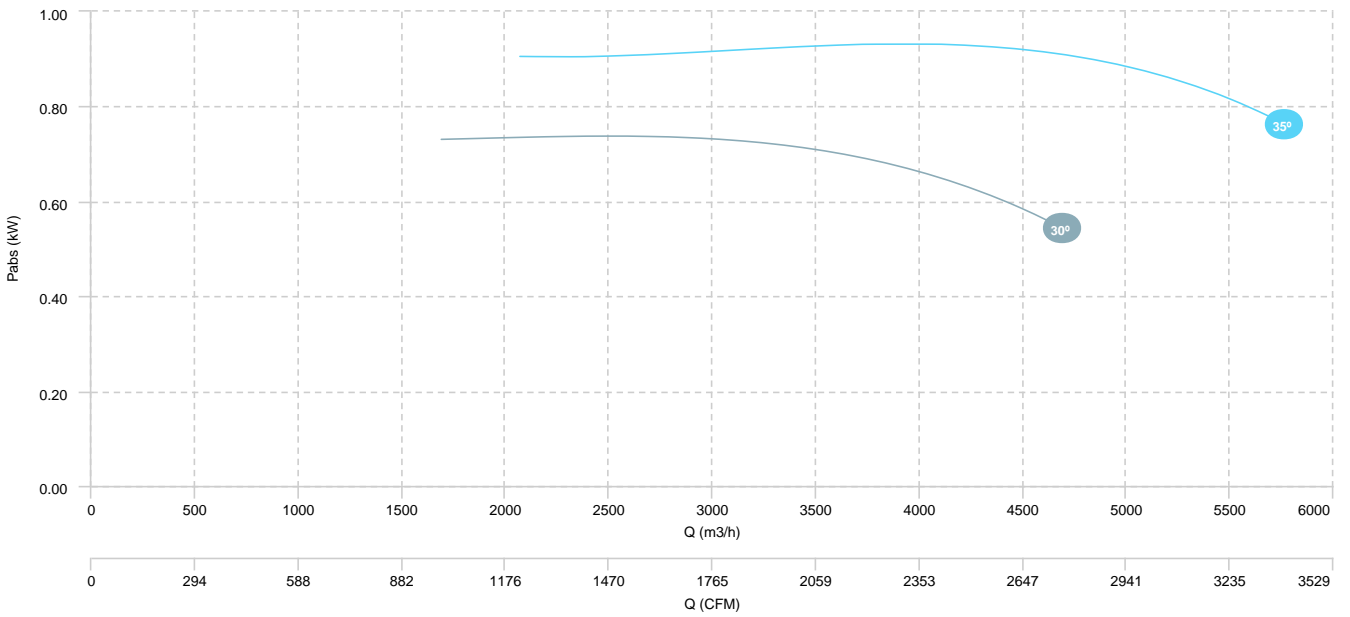

HM 35 T4 0,12kW (A0:6)

AIR FLOW - PRESSURE

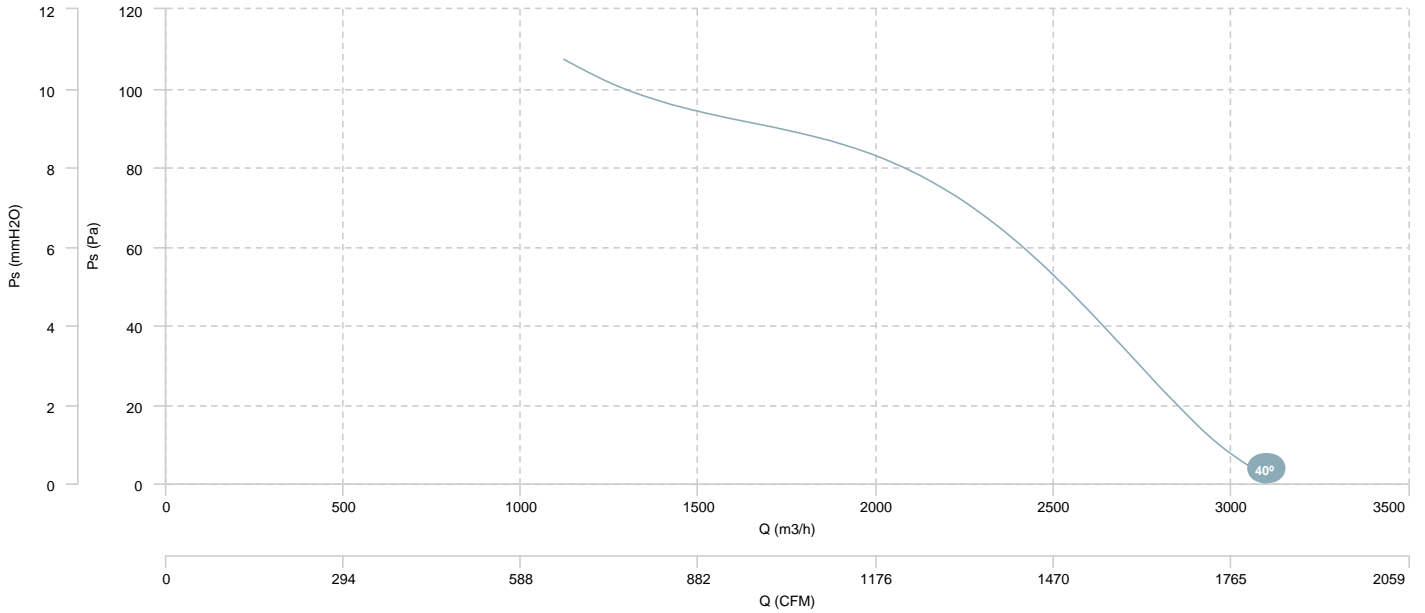

AIR FLOW - ABSORBED POWER

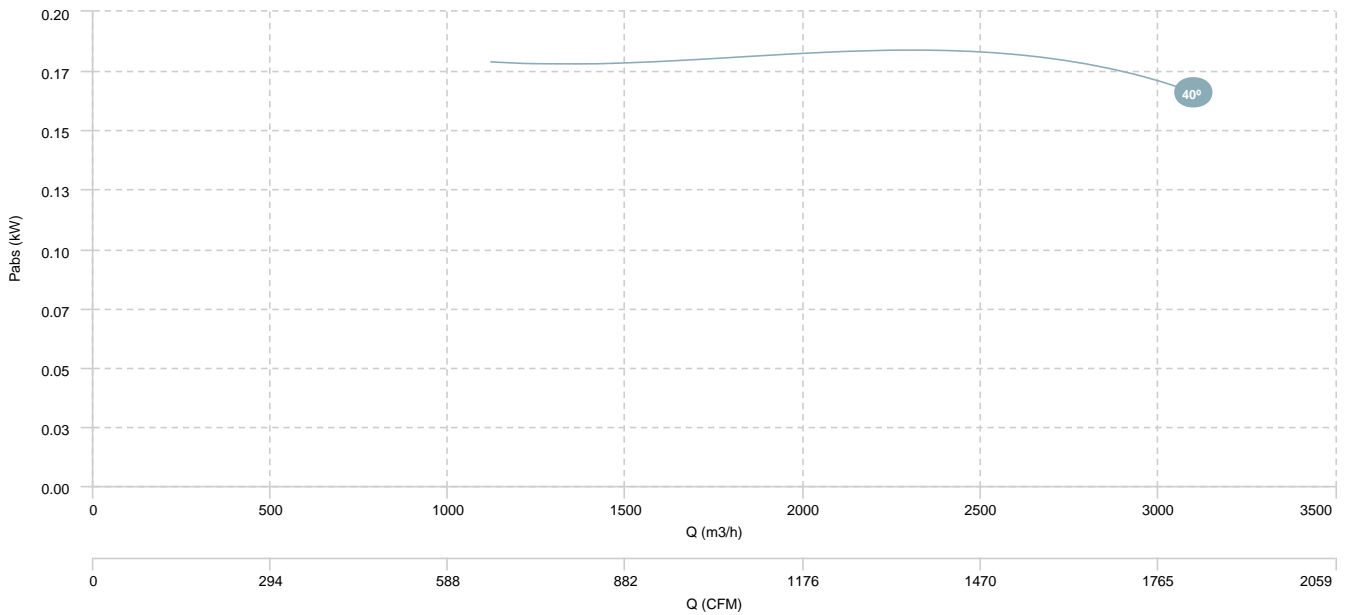

HM 40 T2 1,1kW (A0:6)

AIR FLOW - PRESSURE

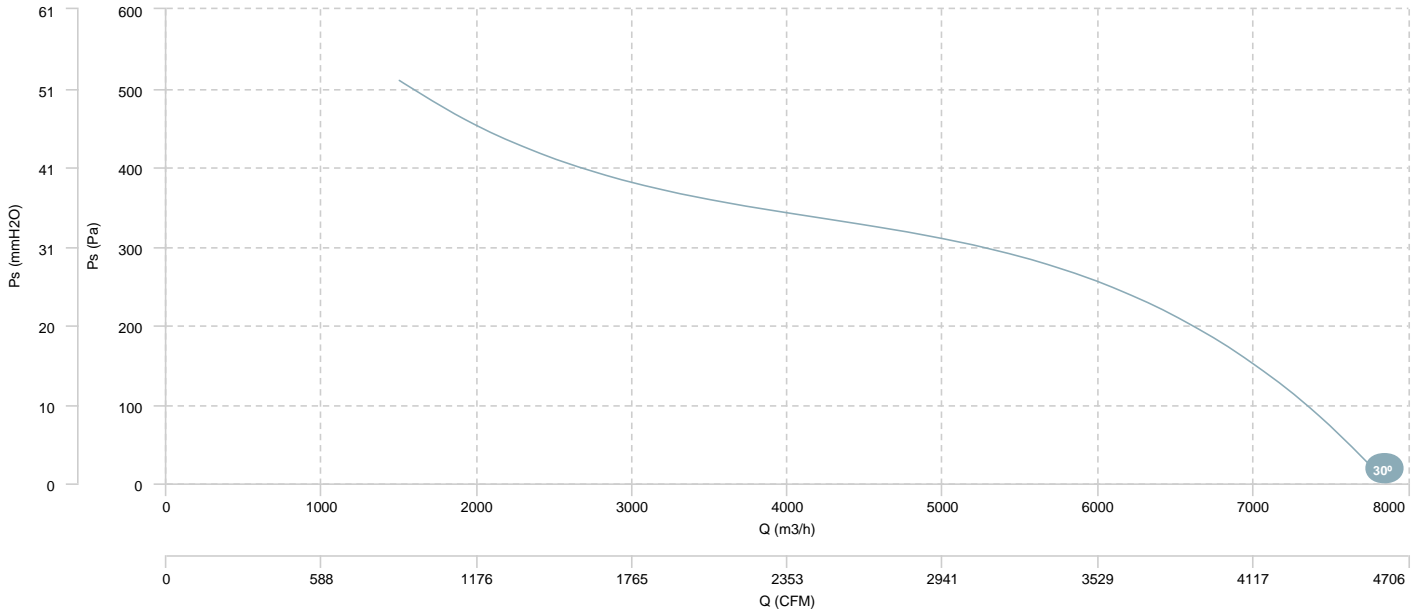

AIR FLOW - ABSORBED POWER

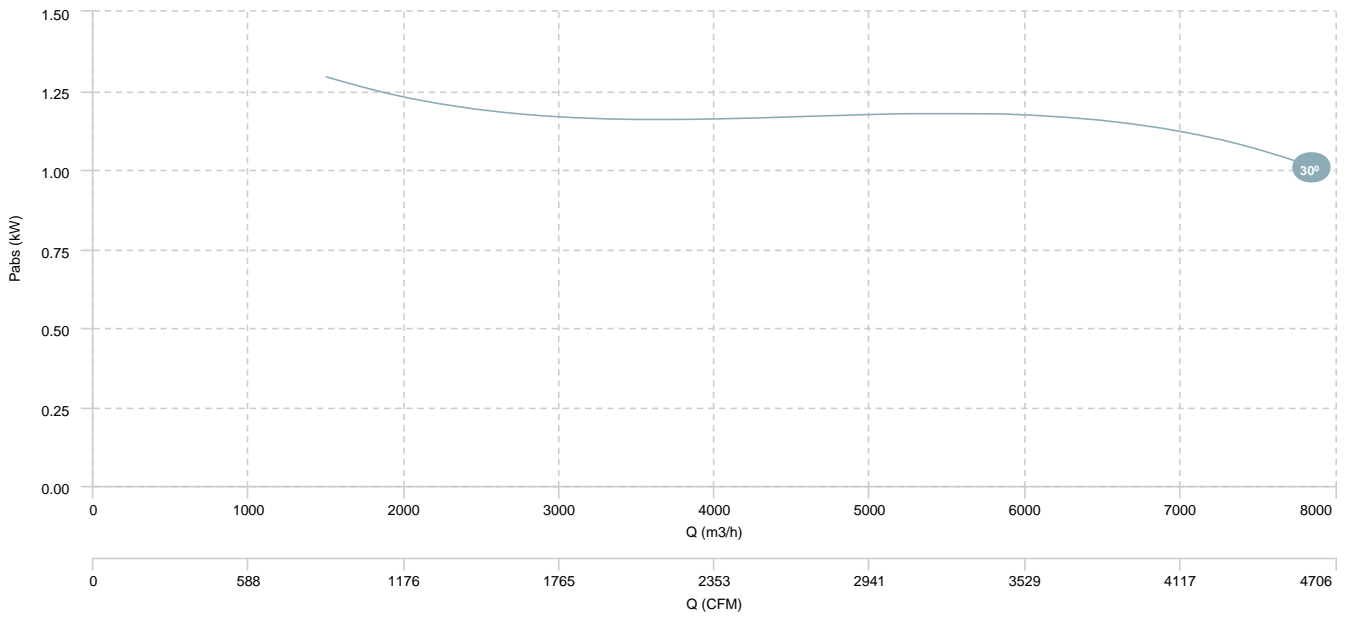



HM 40 T4 0,25kW (A0:6)

AIR FLOW - PRESSURE

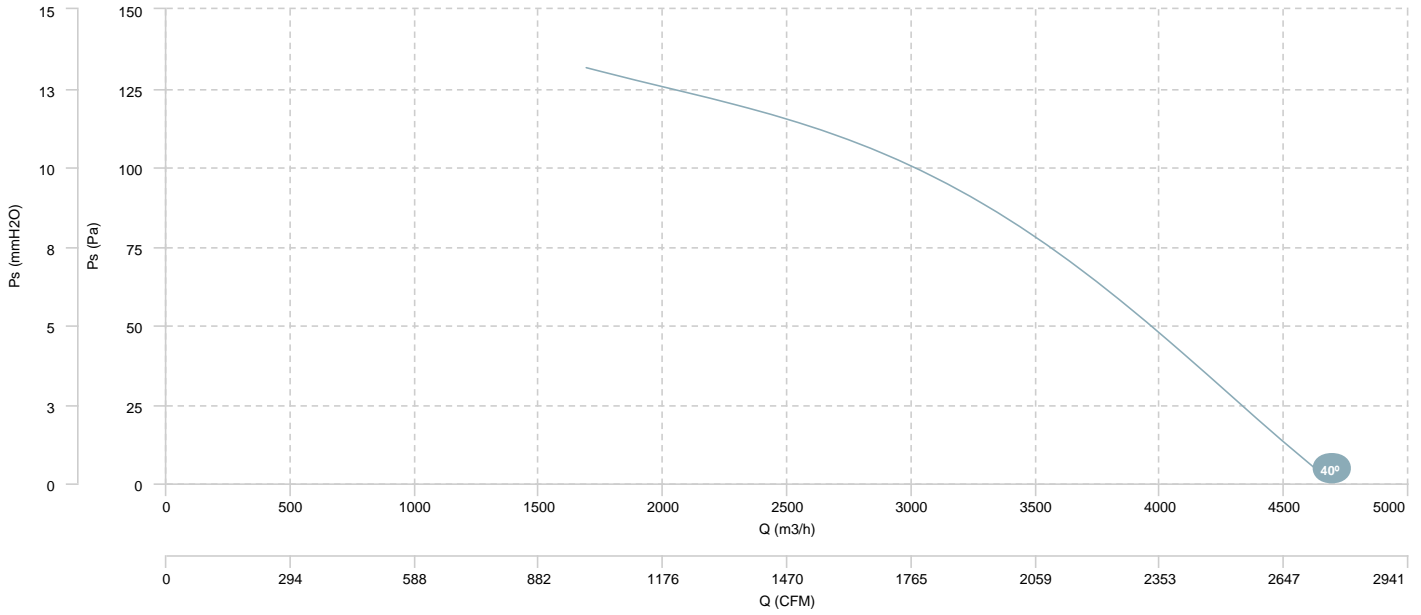

AIR FLOW - ABSORBED POWER

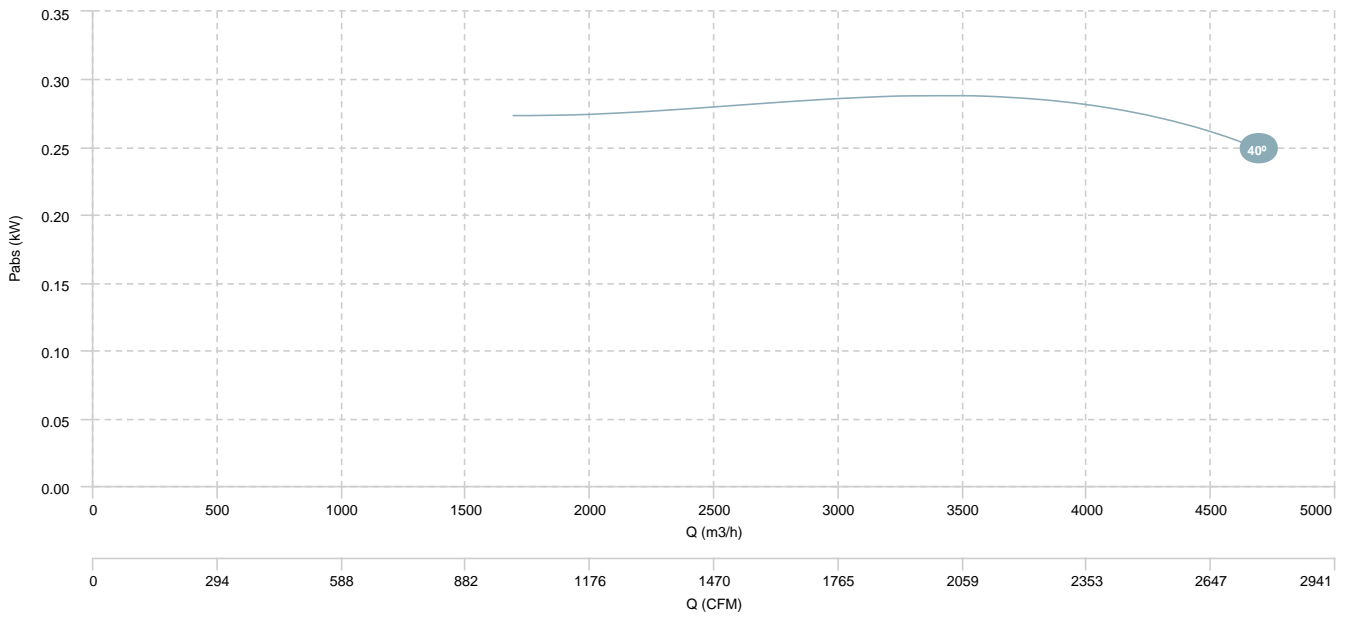

HM 40 T6 0,12kW (A0:6)

AIR FLOW - PRESSURE

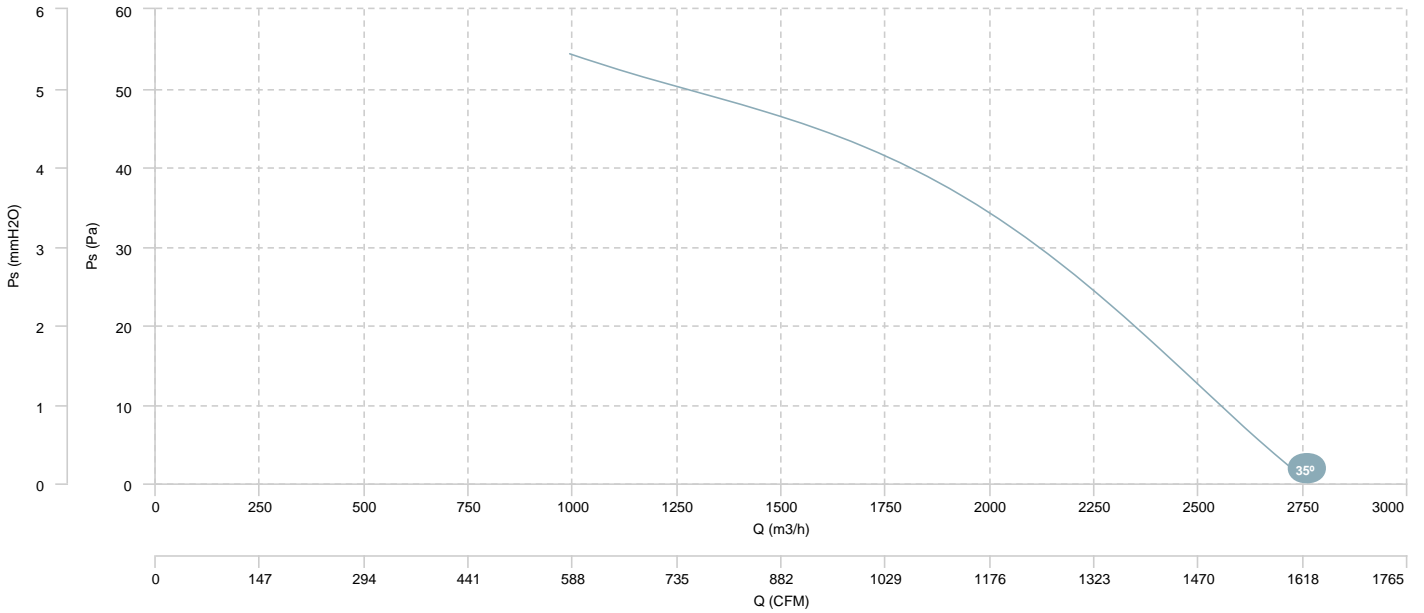

AIR FLOW - ABSORBED POWER

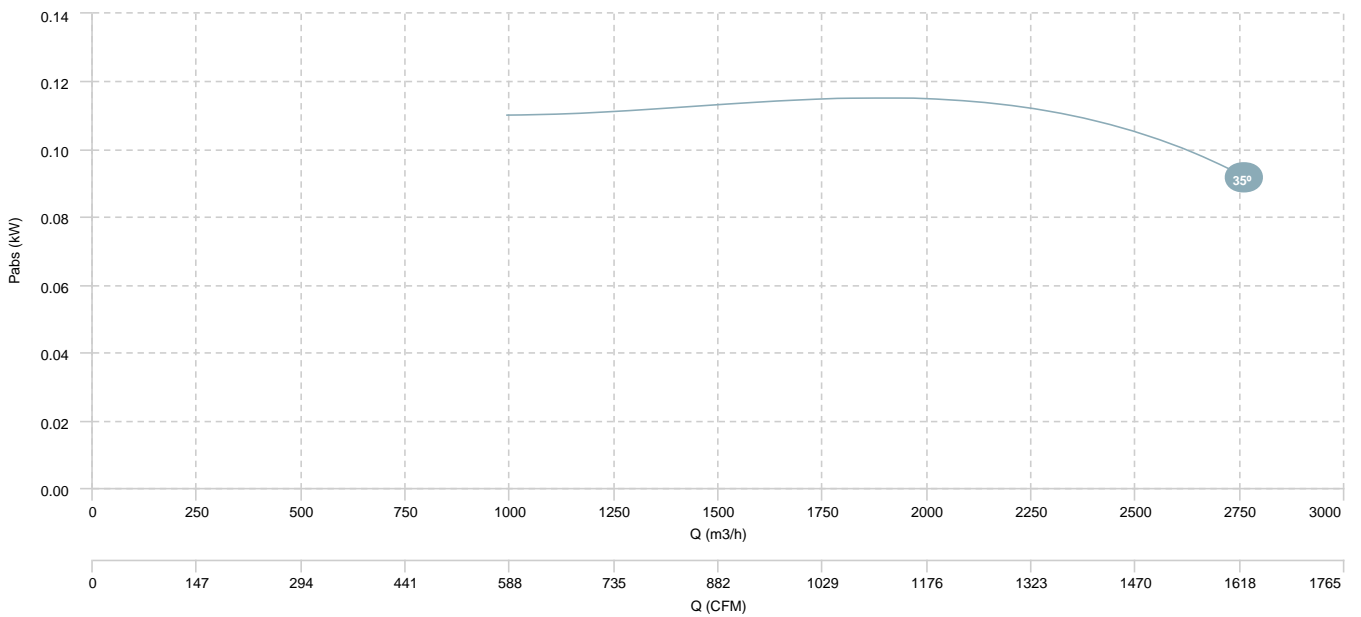

HM 45 T2 0,75kW (A9:4)	HM 45 T2 1,1kW (A9:4)	HM 45 T2 1,5kW (A9:4)
HM 45 T2 2,2kW (A9:4)	HM 45 T2 3kW (A9:4)	

## AIR FLOW - PRESSURE

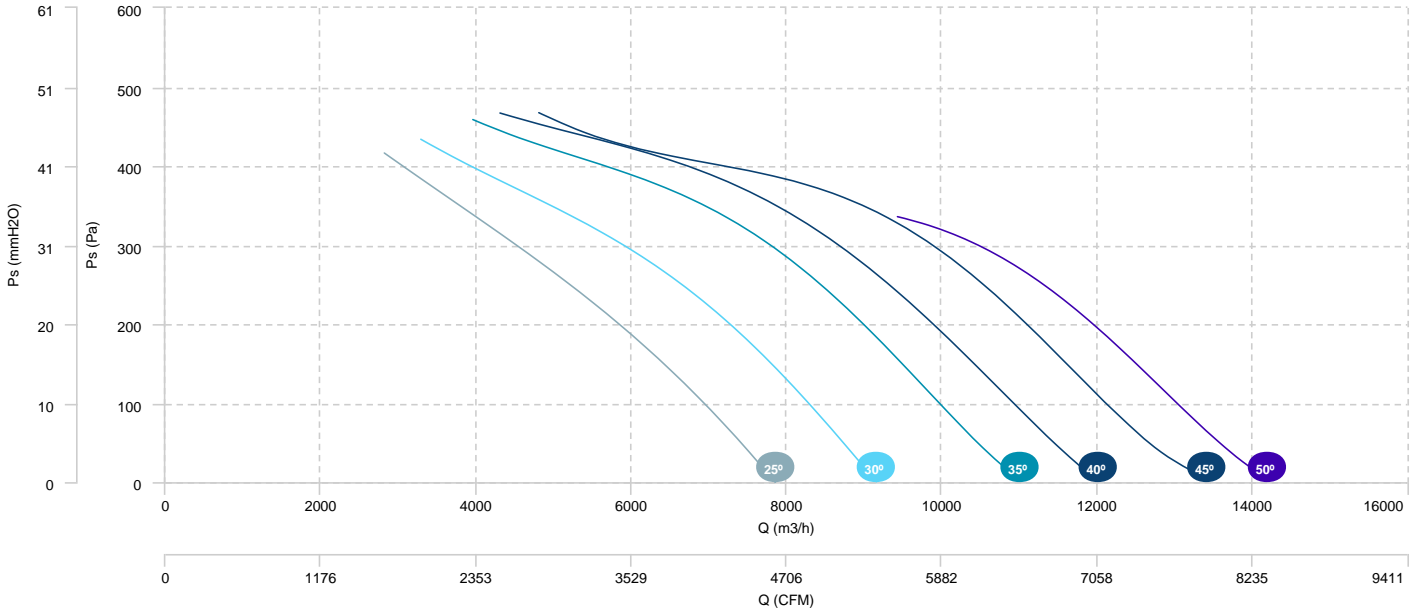

## AIR FLOW - ABSORBED POWER

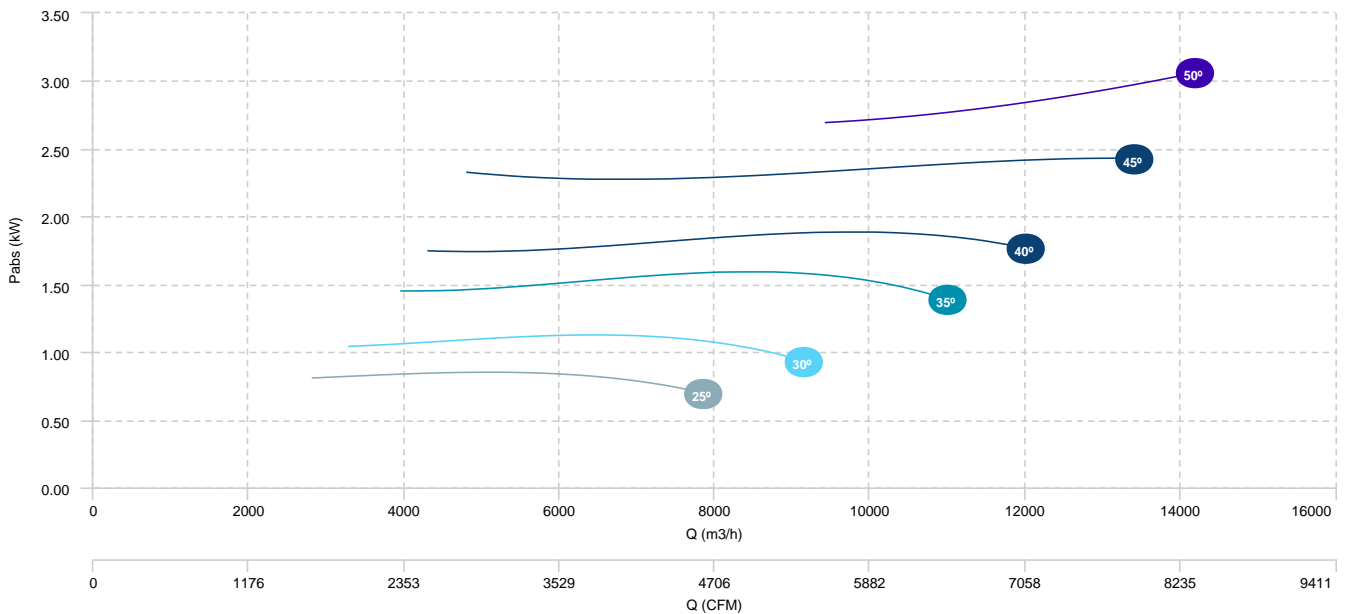

HM 45 T2 1,5kW (A0:6)

HM 45 T2 2,2kW (A0:6)

AIR FLOW - PRESSURE

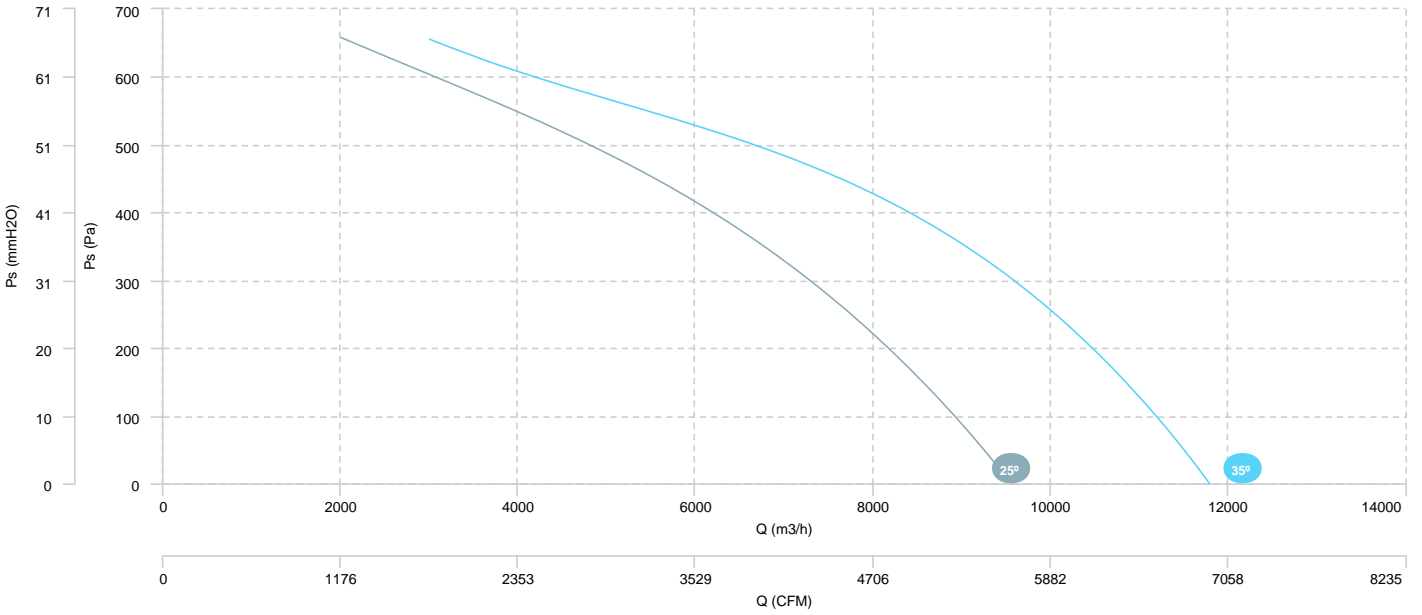

AIR FLOW - ABSORBED POWER

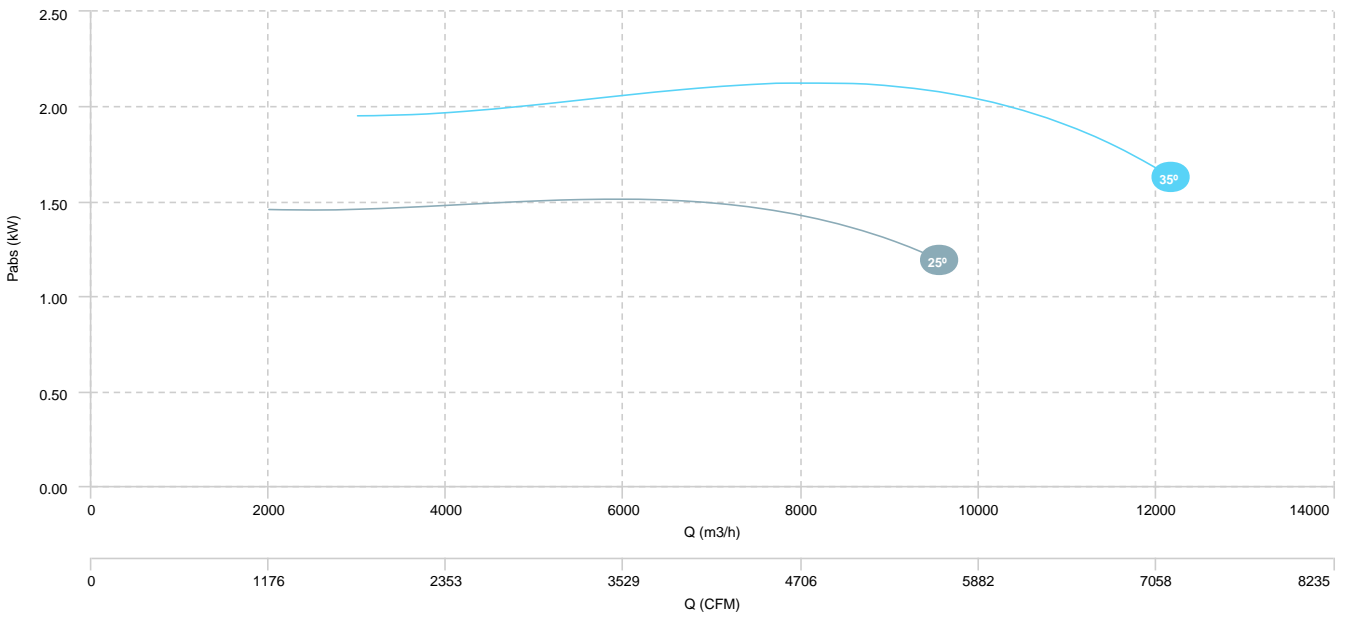

HM 45 T2 1,1kW (A9:8)	HM 45 T2 1,5kW (A9:8)	HM 45 T2 2,2kW (A9:8)
HM 45 T2 3kW (A9:8)		

## AIR FLOW - PRESSURE

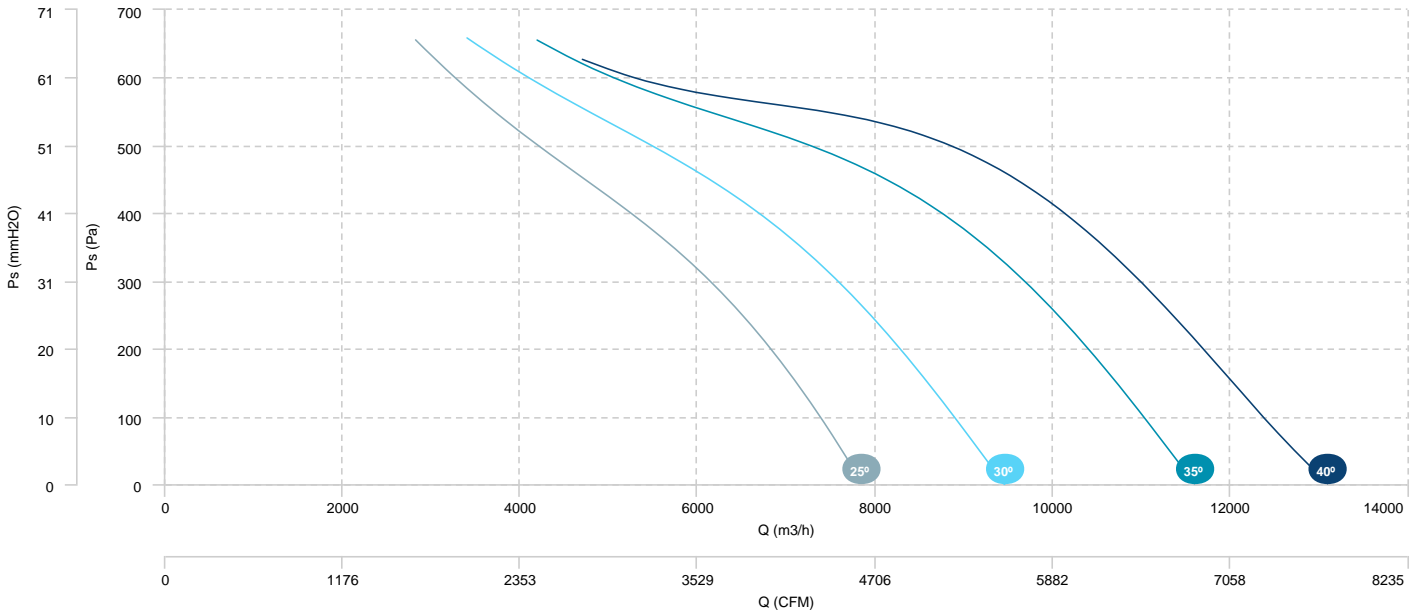

## AIR FLOW - ABSORBED POWER

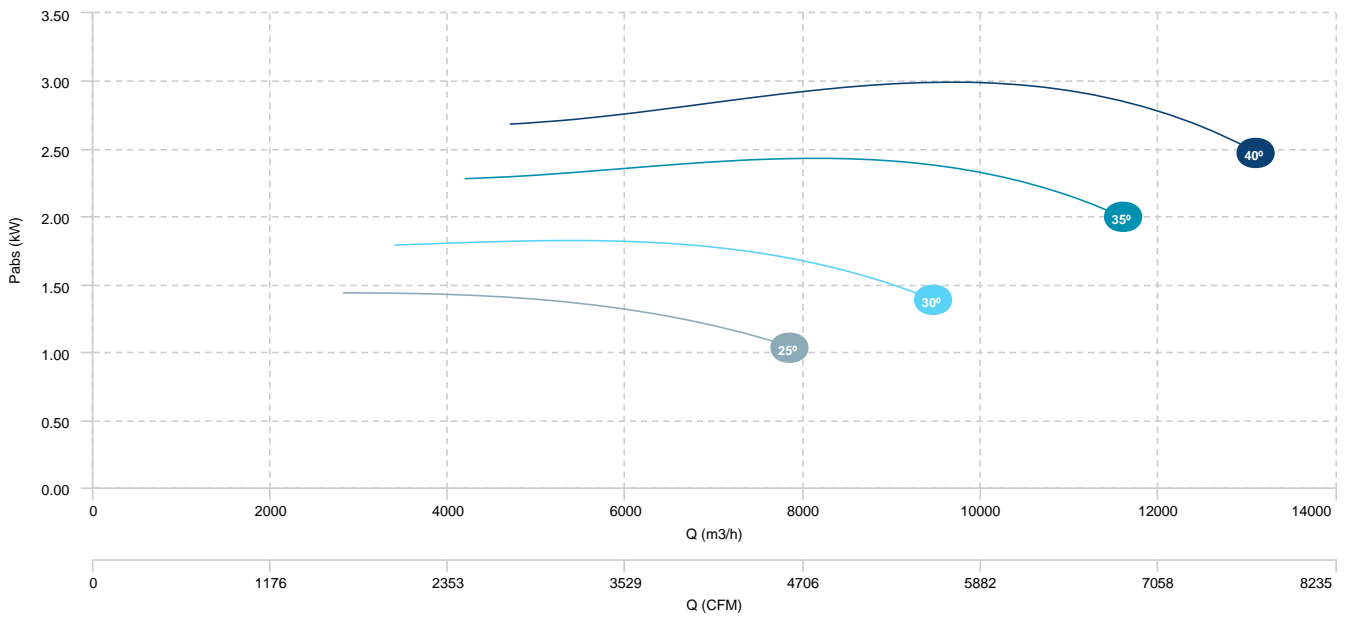

HM 45 T4 0,55kW (A0:6)

AIR FLOW - PRESSURE

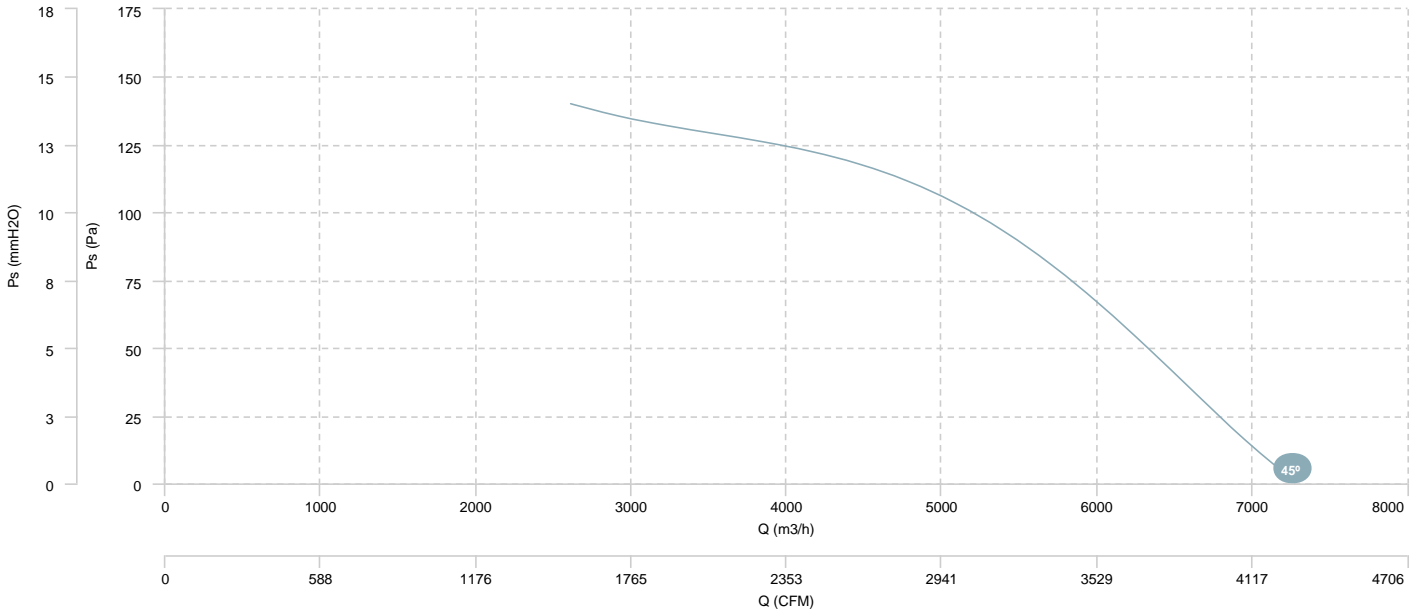

AIR FLOW - ABSORBED POWER

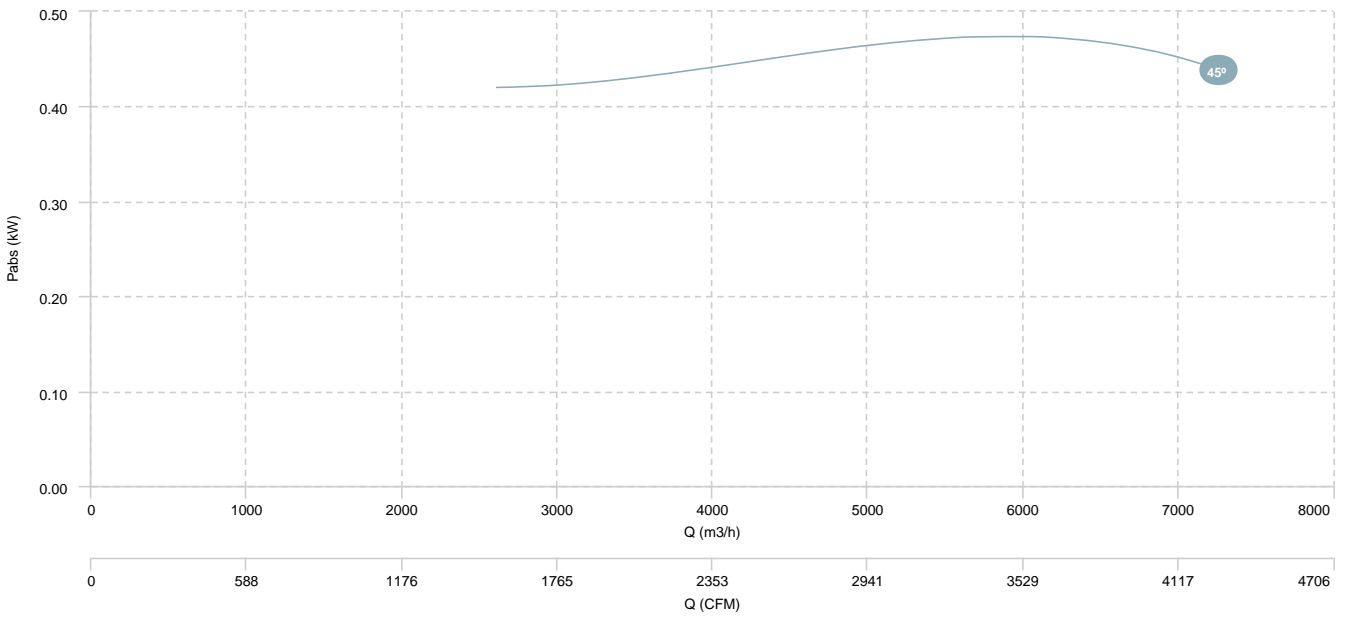

HM 45 T6 0,13kW (A0:6)

AIR FLOW - PRESSURE

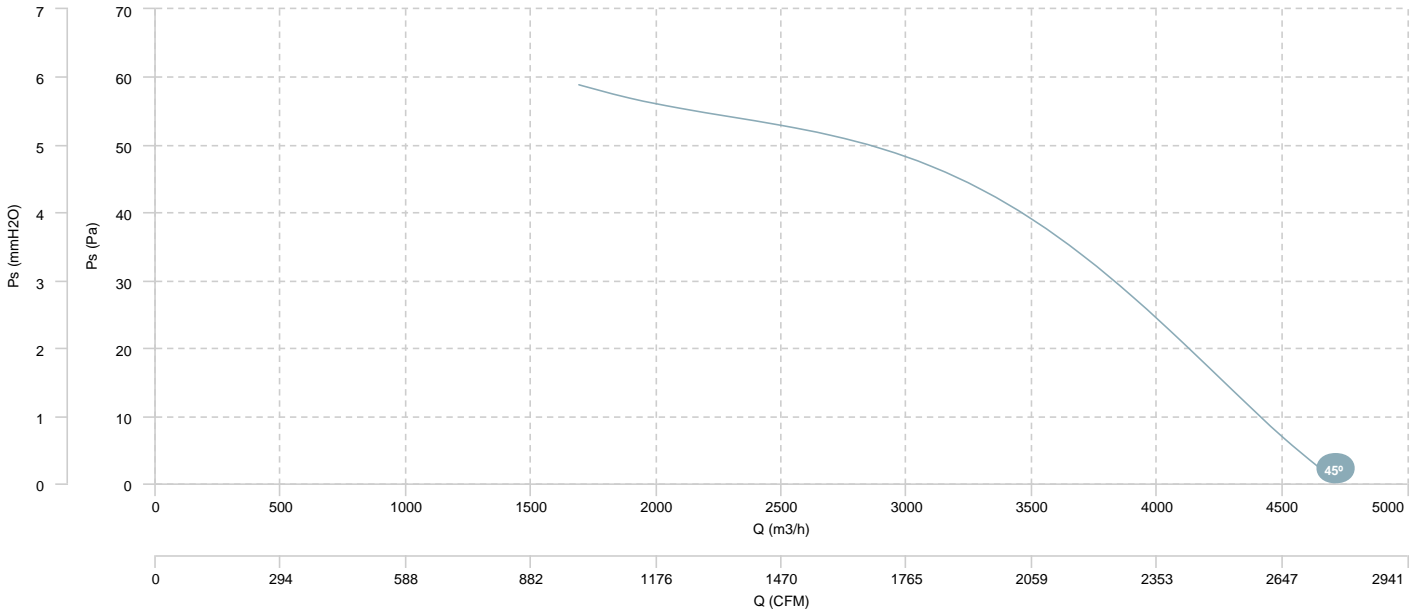

AIR FLOW - ABSORBED POWER

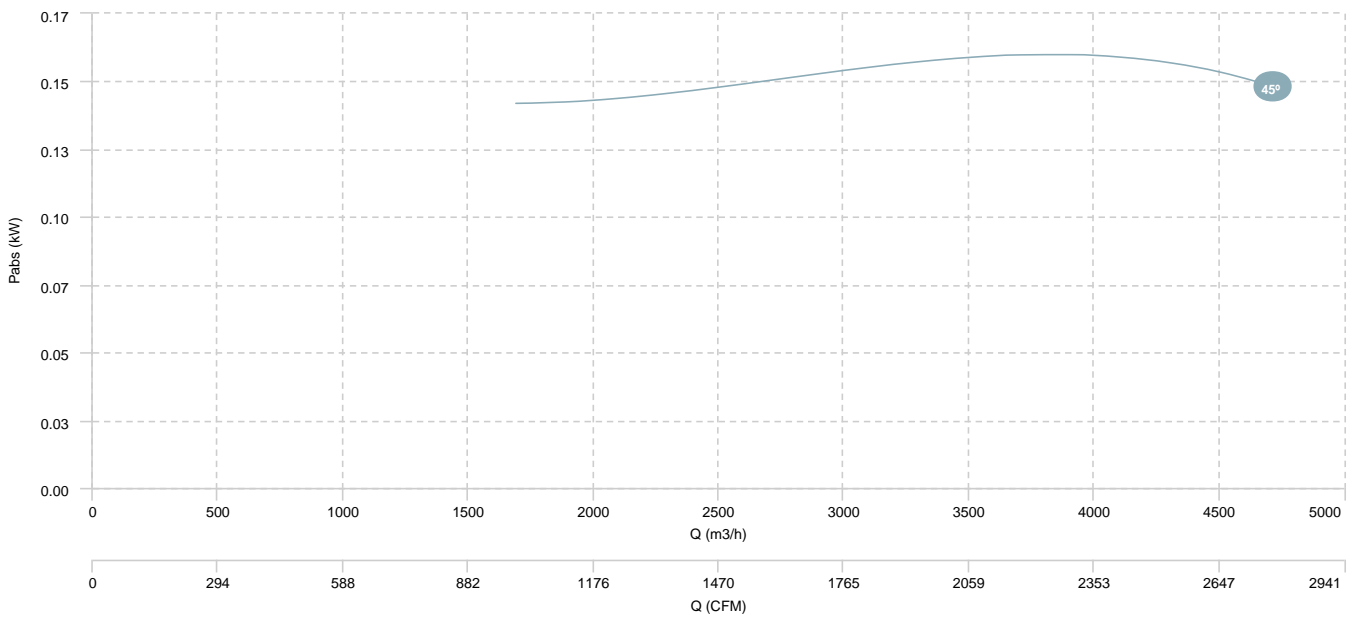

HM 45 T2/T4 1,1/0,25kW (A9:8)	HM 45 T2/T4 1,5/0,37kW (A9:8)	HM 45 T2/T4 2,2/0,55kW (A9:8)
HM 45 T2/T4 3/0,75kW (A9:8)		

## AIR FLOW - PRESSURE (2 poles)

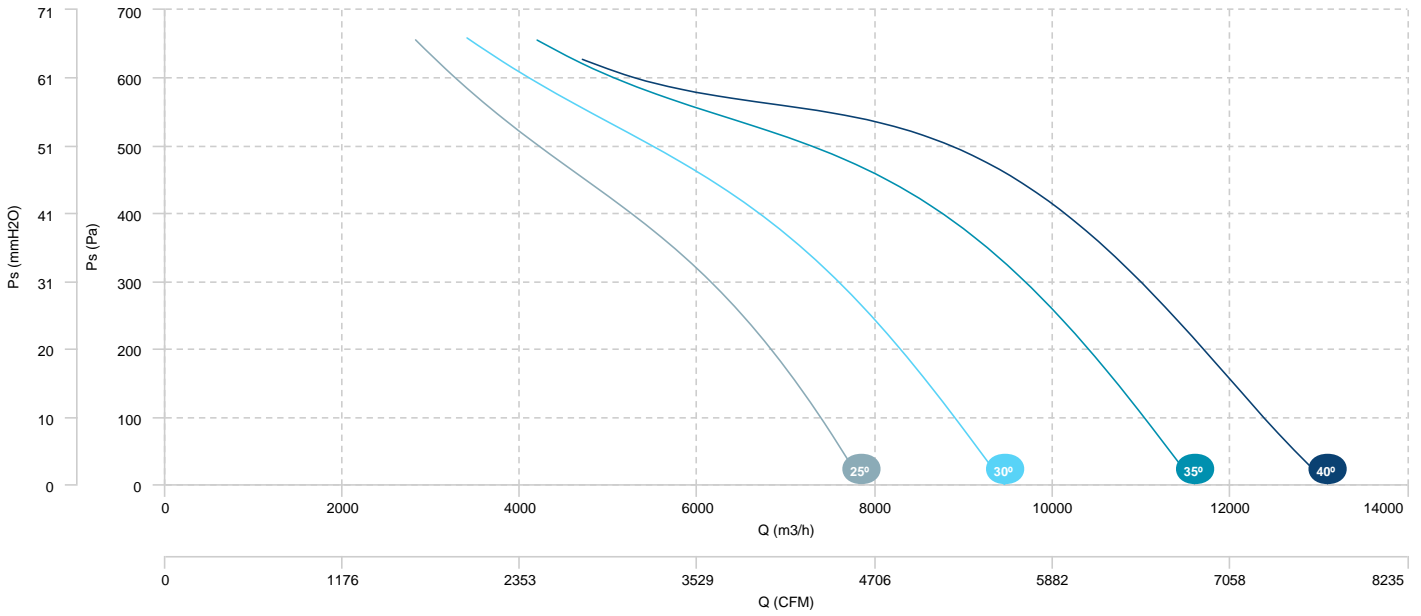

## AIR FLOW - ABSORBED POWER (2 poles)

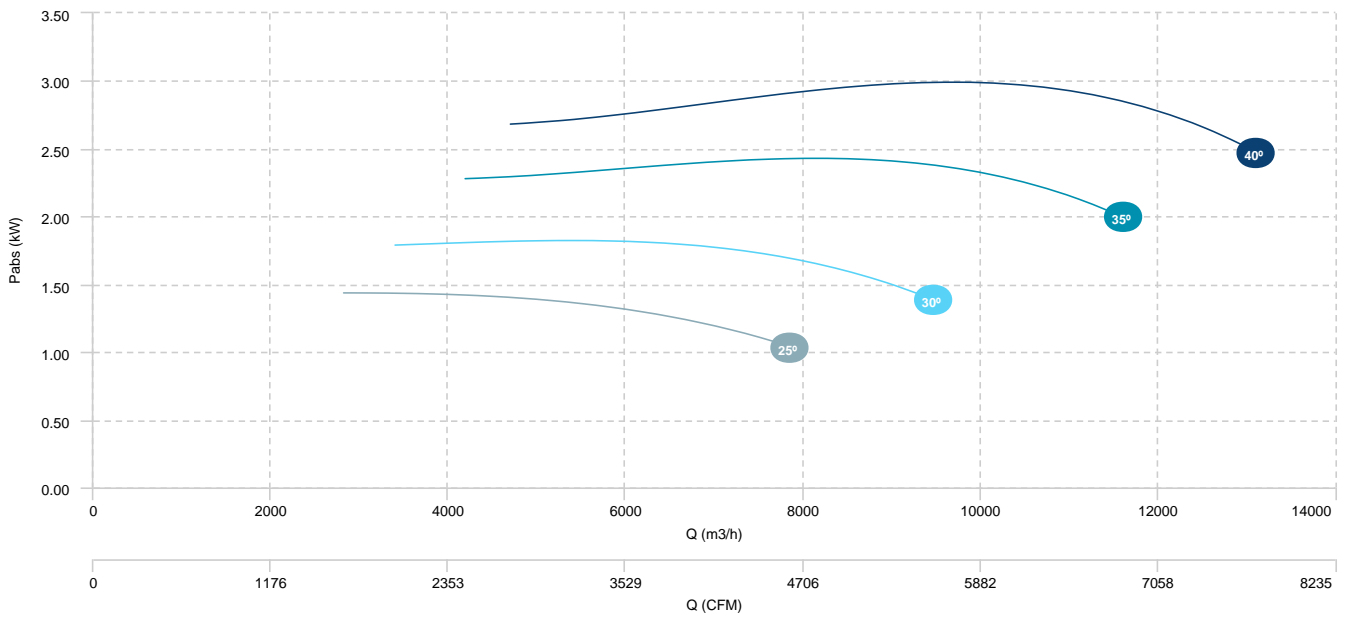



HM 45 T2/T4 1,1/0,25kW (A9:8)	HM 45 T2/T4 1,5/0,37kW (A9:8)	HM 45 T2/T4 2,2/0,55kW (A9:8)
HM 45 T2/T4 3/0,75kW (A9:8)		

AIR FLOW - PRESSURE (4 poles)

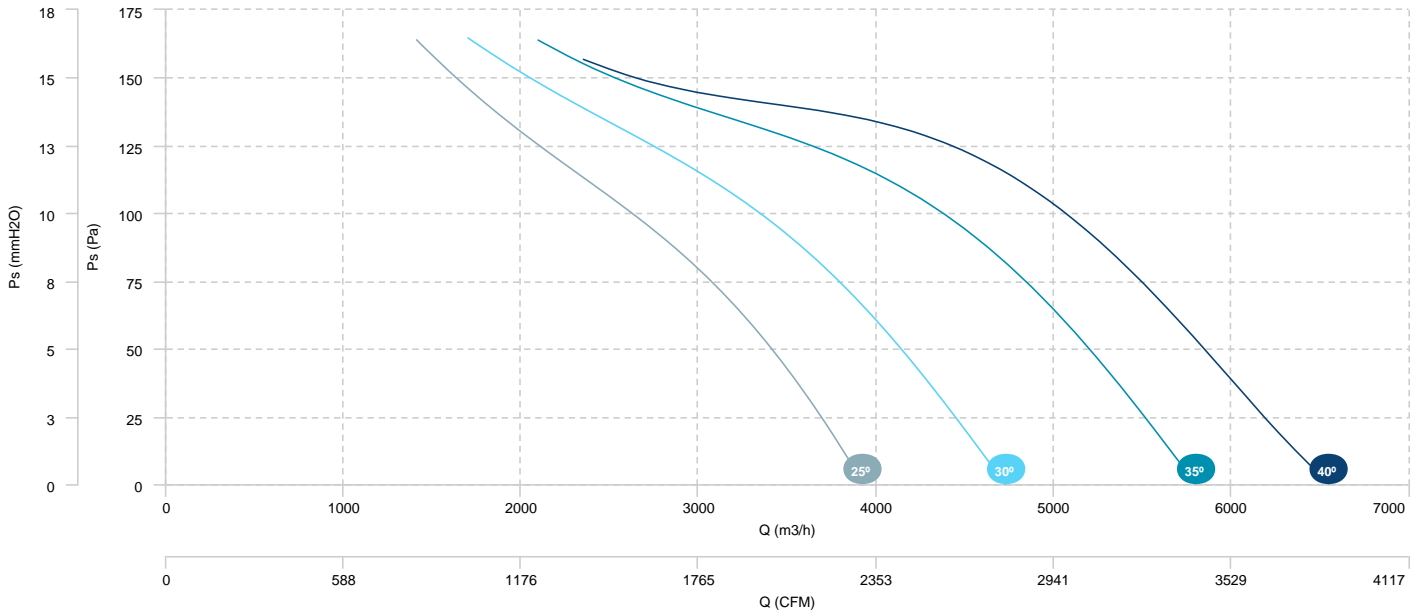

HM 45 T2/T4 0,75/0,18kW (A9:4)	HM 45 T2/T4 1,1/0,25kW (A9:4)	HM 45 T2/T4 1,5/0,37kW (A9:4)
HM 45 T2/T4 2,2/0,55kW (A9:4)	HM 45 T2/T4 3/0,75kW (A9:4)	

## AIR FLOW - PRESSURE (2 poles)

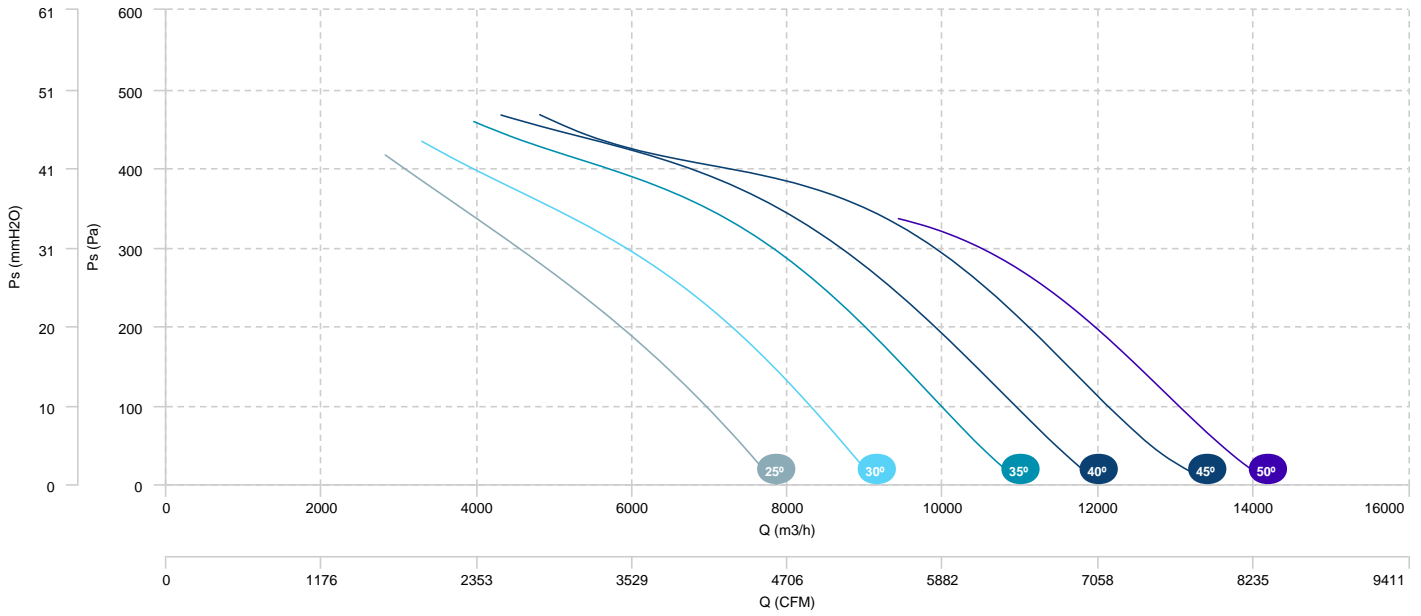

## AIR FLOW - ABSORBED POWER (2 poles)

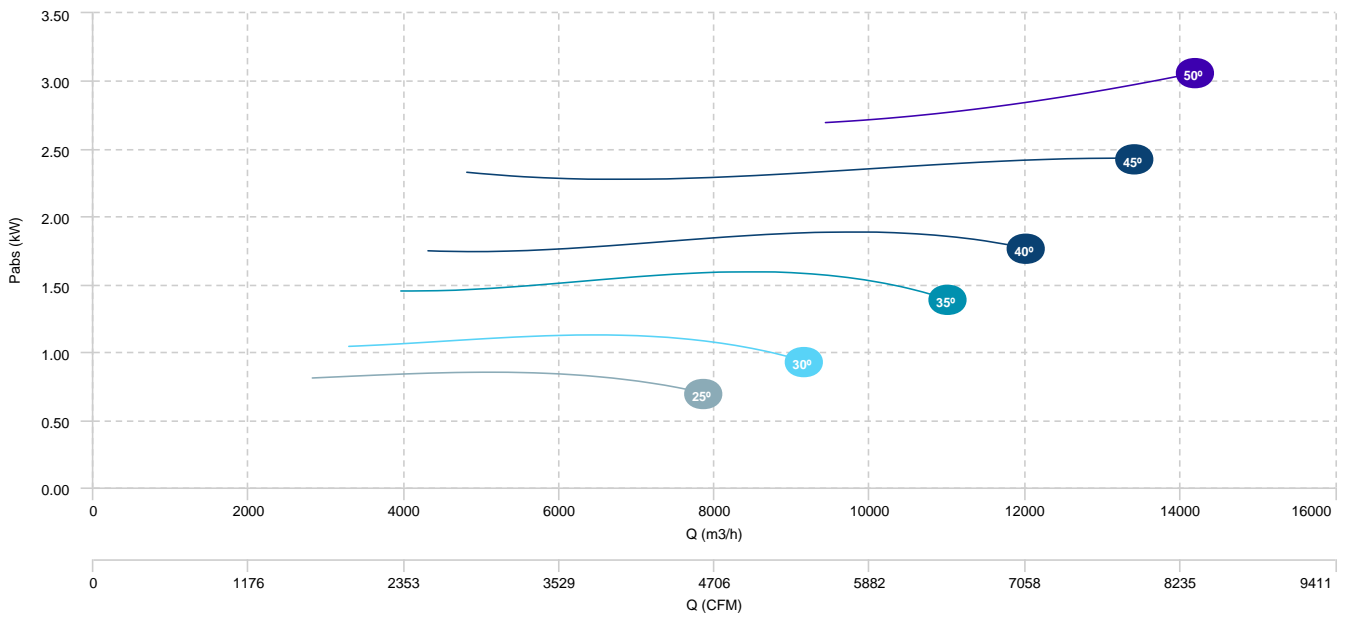

HM 45 T2/T4 0,75/0,18kW (A9:4)	HM 45 T2/T4 1,1/0,25kW (A9:4)	HM 45 T2/T4 1,5/0,37kW (A9:4)
HM 45 T2/T4 2,2/0,55kW (A9:4)	HM 45 T2/T4 3/0,75kW (A9:4)	

## AIR FLOW - PRESSURE (4 poles)

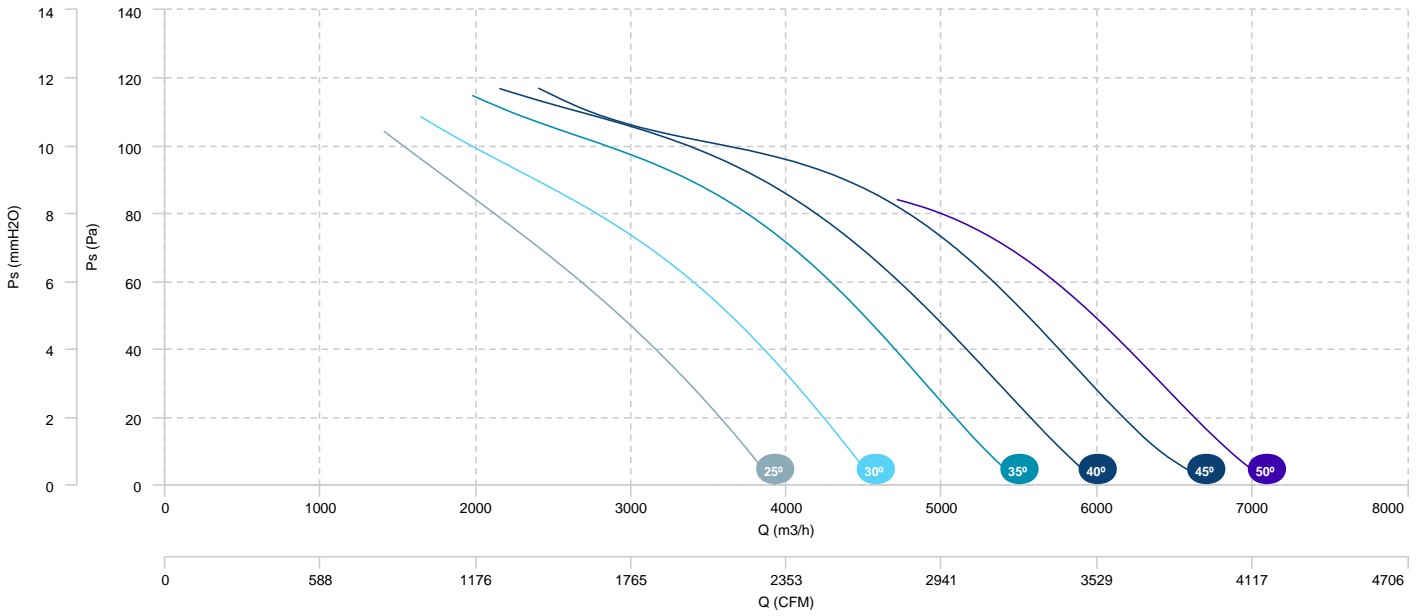

HM 45 T4/T6 0,55/0,18kW (A0:6)

AIR FLOW - PRESSURE (4 poles)

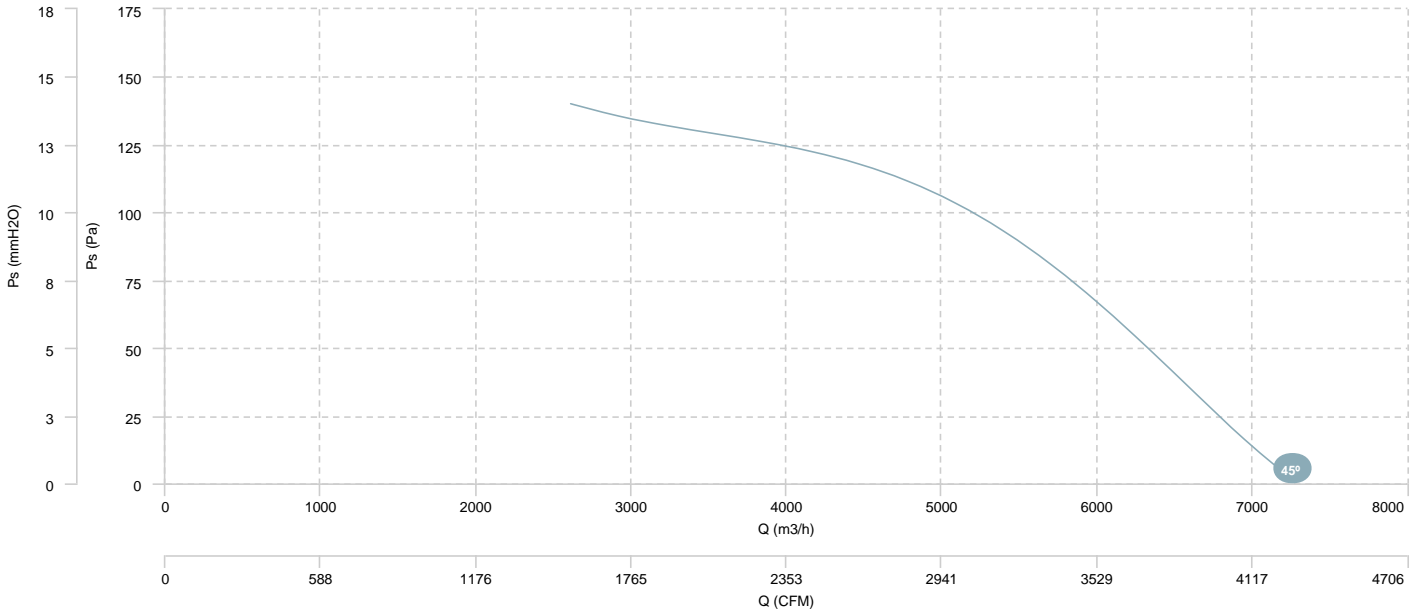

AIR FLOW - ABSORBED POWER (4 poles)

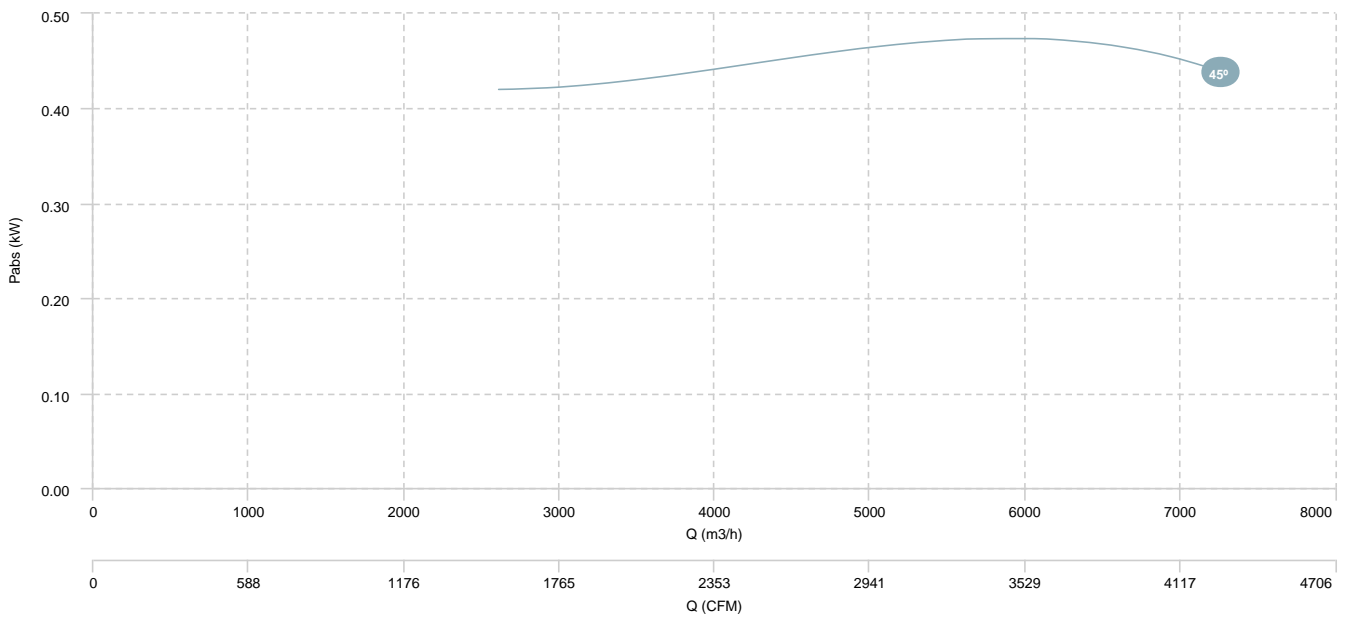

HM 45 T4/T6 0,55/0,18kW (A0:6)

AIR FLOW - PRESSURE (6 poles)

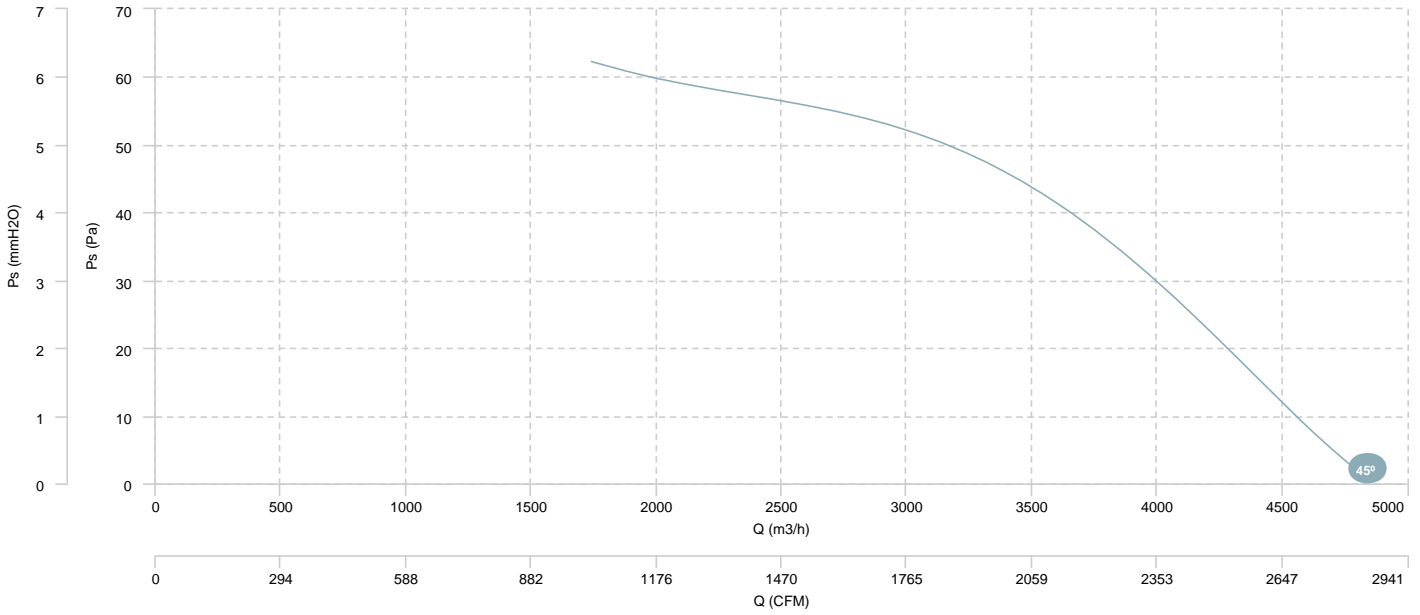

HM 45 T4/T8 0,33/0,04kW (A0:6)

AIR FLOW - PRESSURE (4 poles)

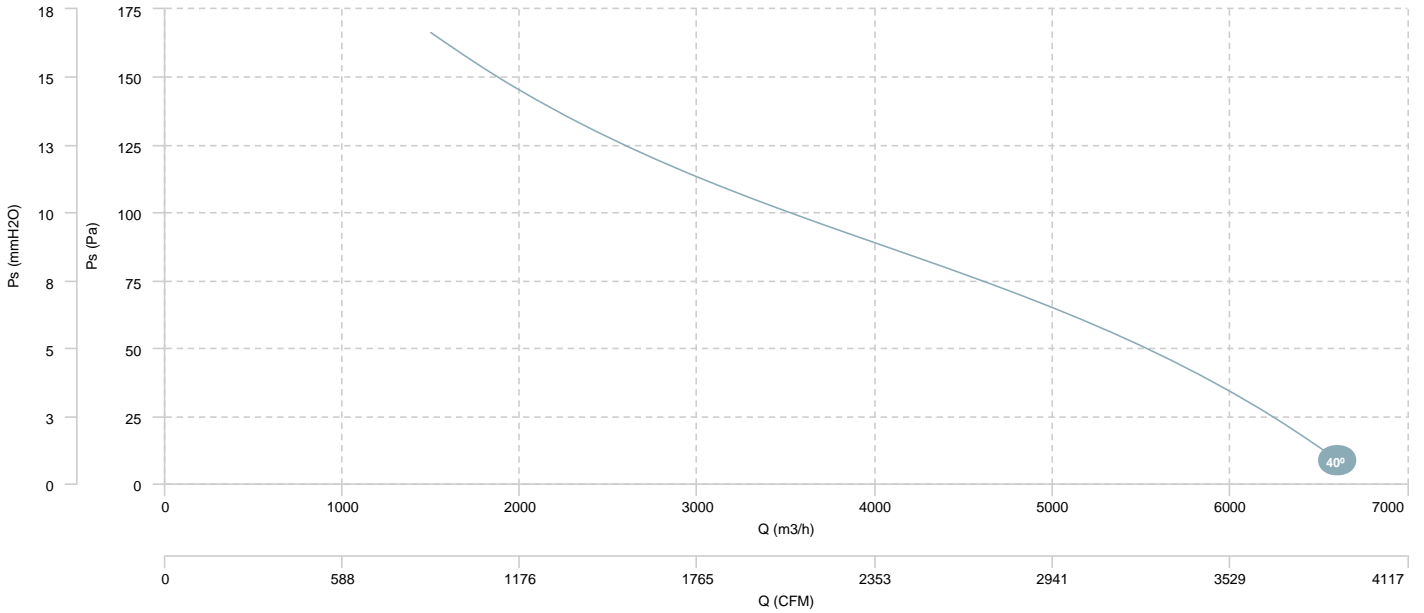

AIR FLOW - ABSORBED POWER (4 poles)

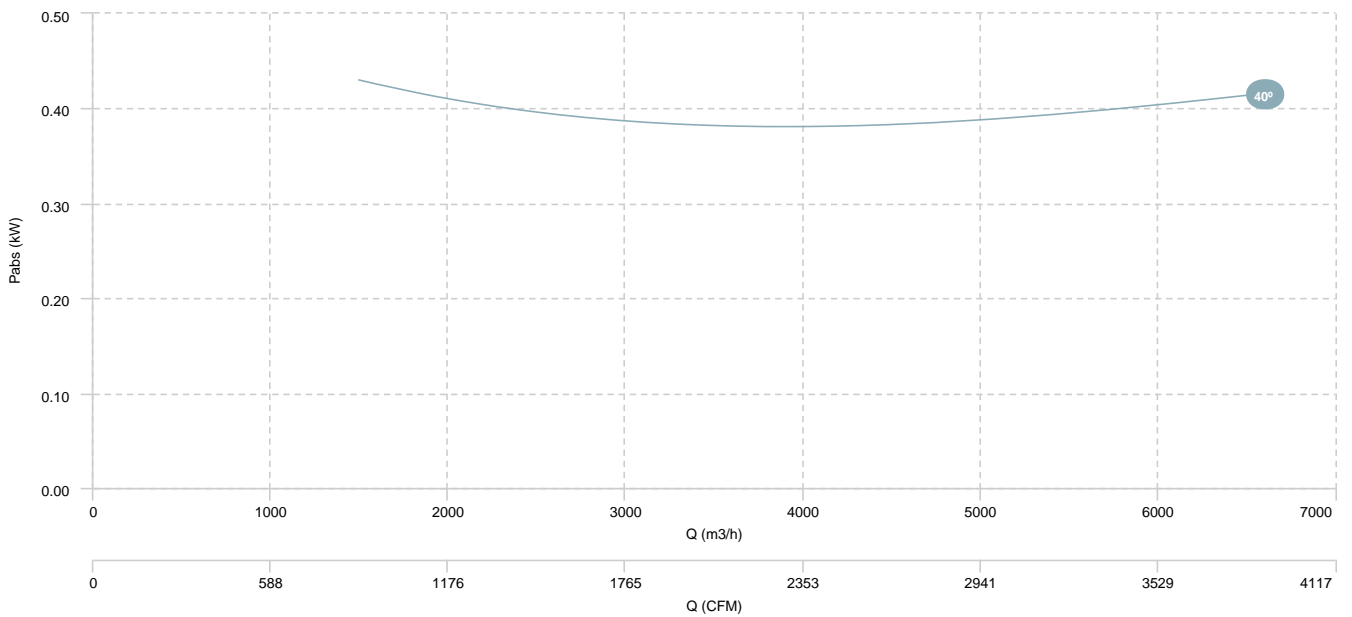

HM 45 T4/T8 0,33/0,04kW (A0:6)

AIR FLOW - PRESSURE (8 poles)

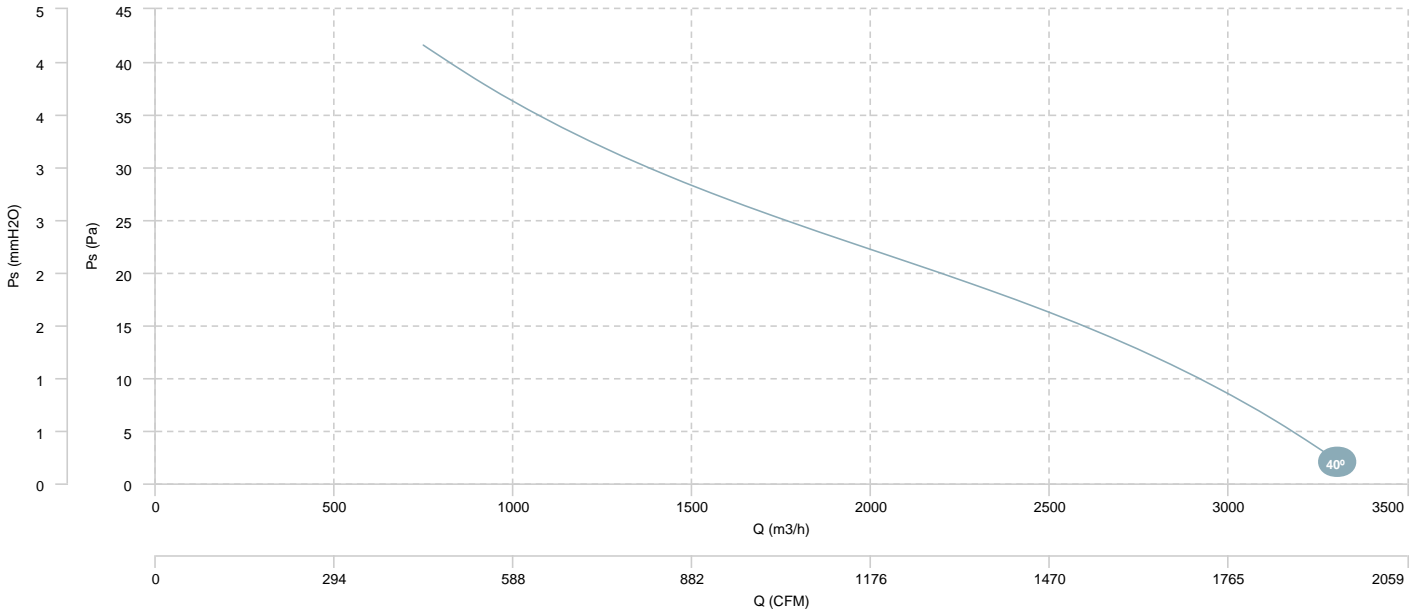

HM 50 T2 1,5kW (A9:8)	HM 50 T2 2,2kW (A9:8)	HM 50 T2 3kW (A9:8)
HM 50 T2 4kW (A9:8)		

## AIR FLOW - PRESSURE

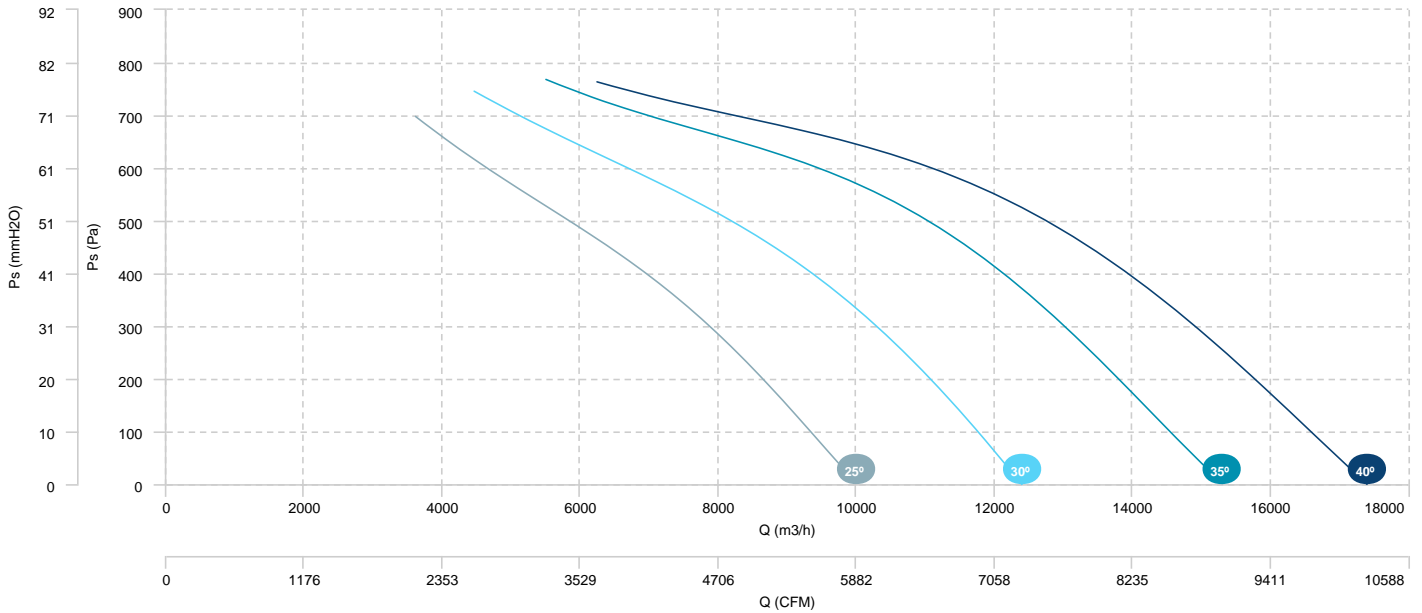

## AIR FLOW - ABSORBED POWER

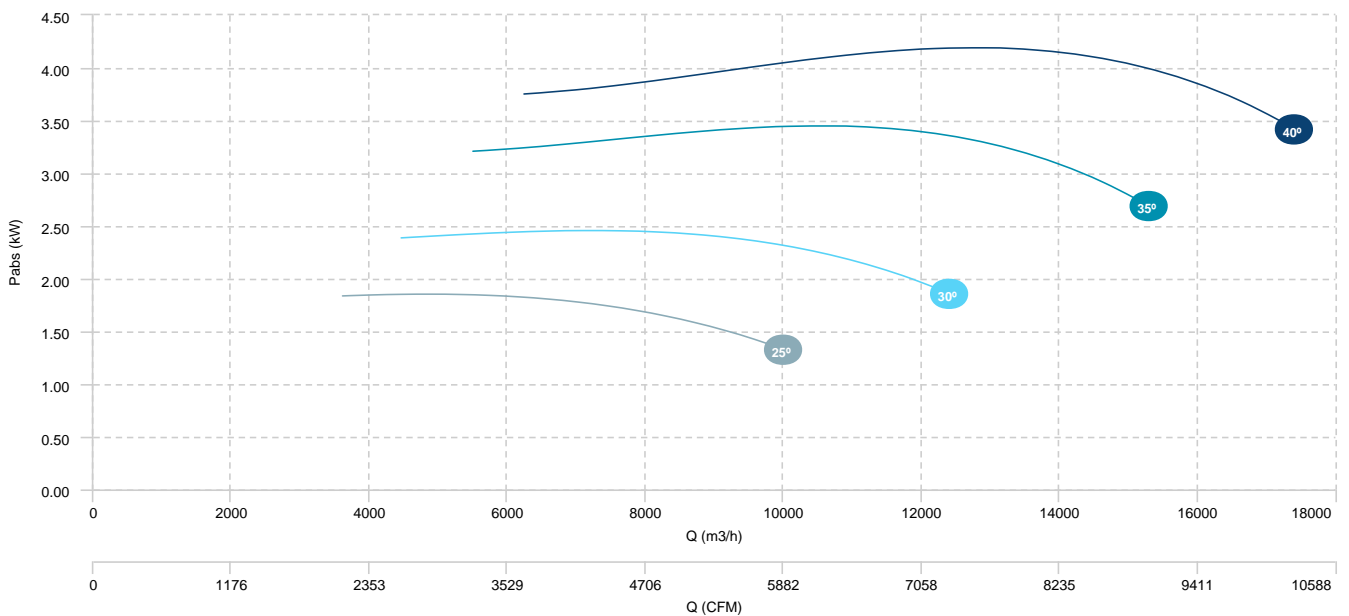



HM 50 T2 1,1kW (A9:4)	HM 50 T2 1,5kW (A9:4)	HM 50 T2 2,2kW (A9:4)
HM 50 T2 3kW (A9:4)	HM 50 T2 4kW (A9:4)	

## AIR FLOW - PRESSURE

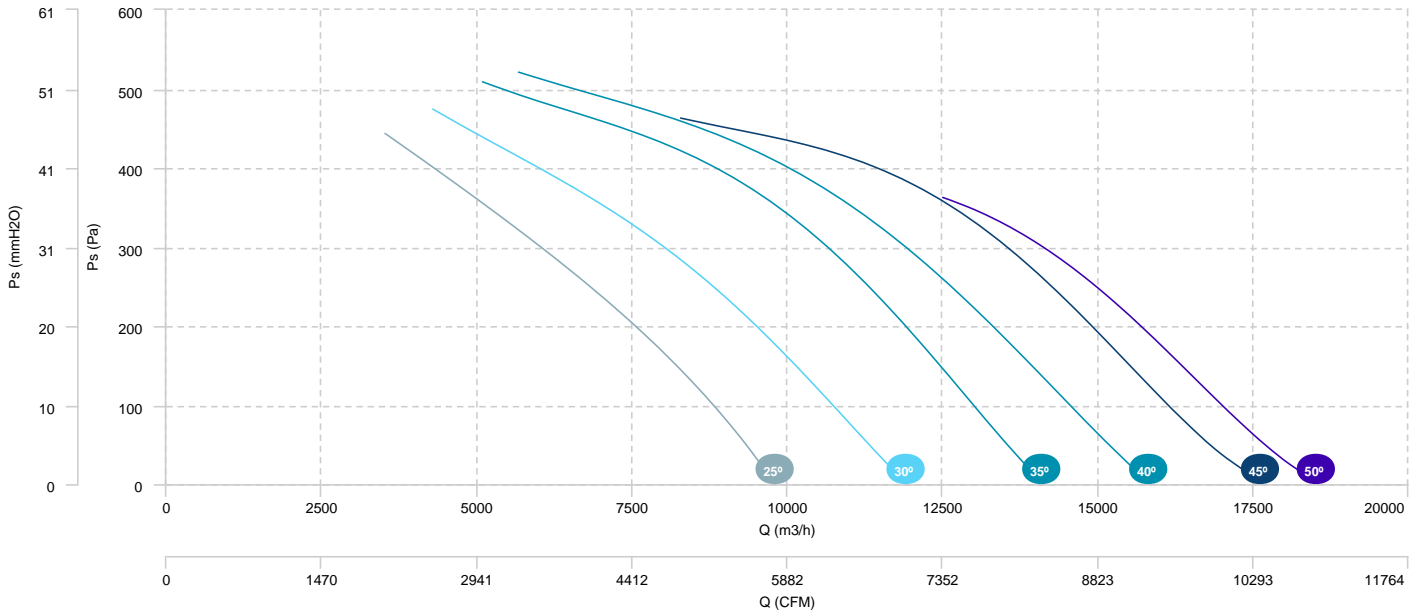

## AIR FLOW - ABSORBED POWER

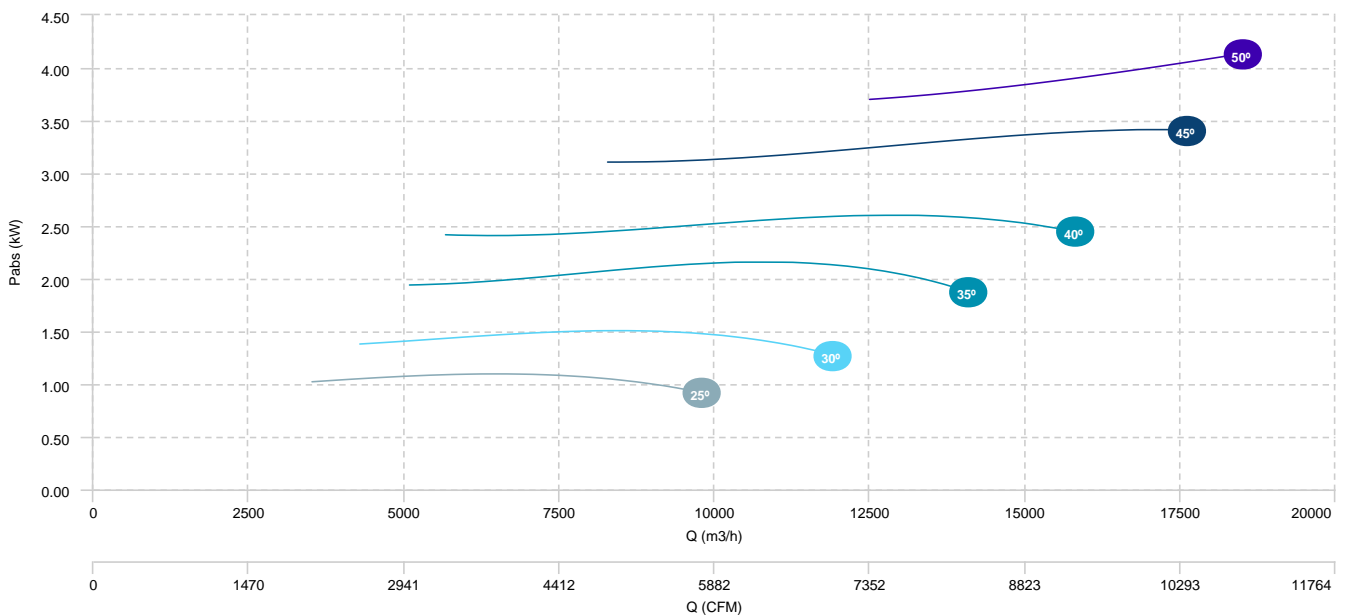

HM 50 T4 0,55kW (A0:6)

AIR FLOW - PRESSURE

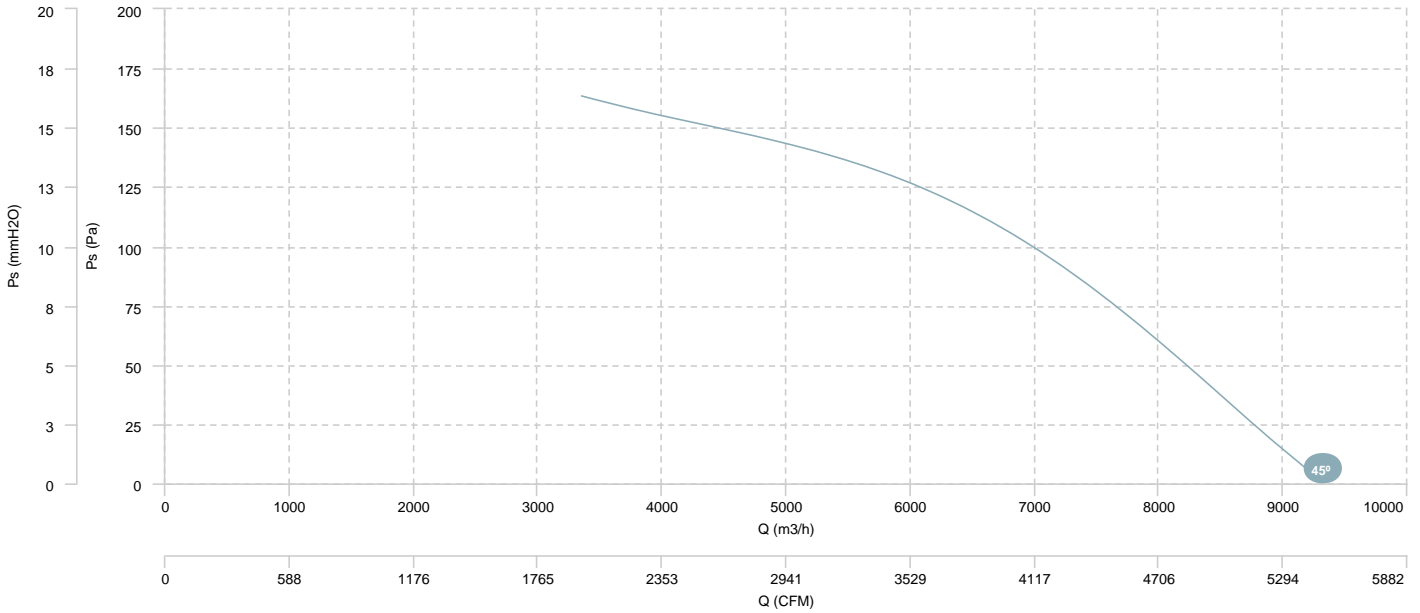

AIR FLOW - ABSORBED POWER

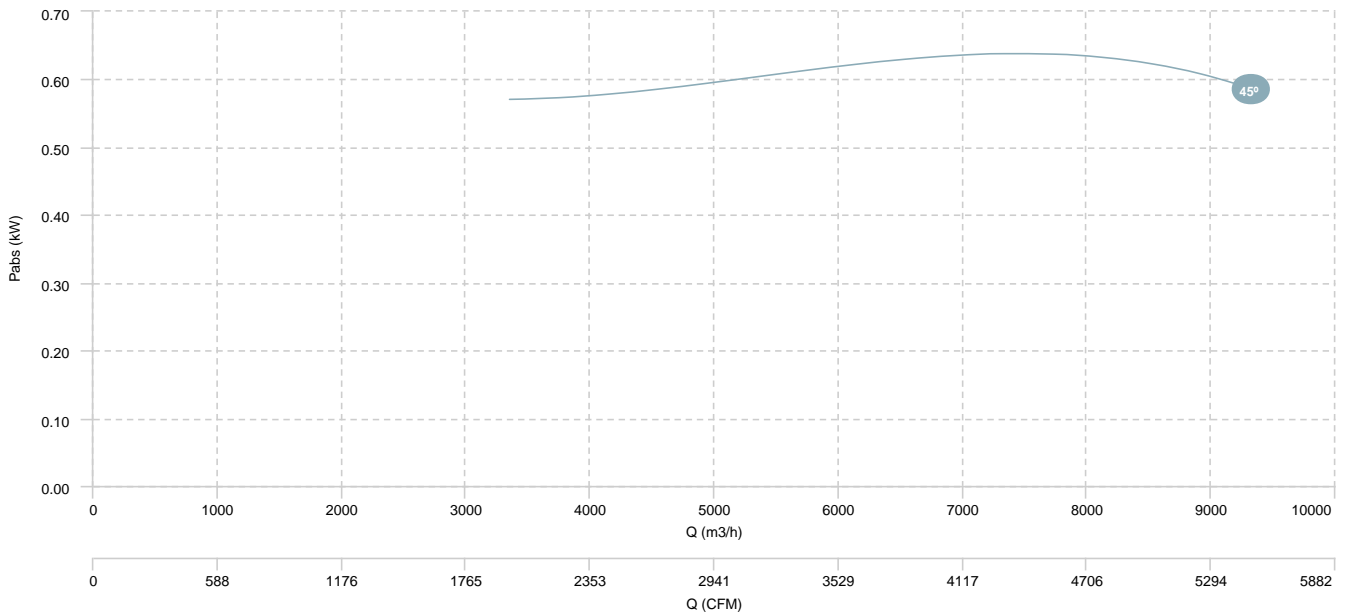

HM 50 T6 0,13kW (A0:6)

AIR FLOW - PRESSURE

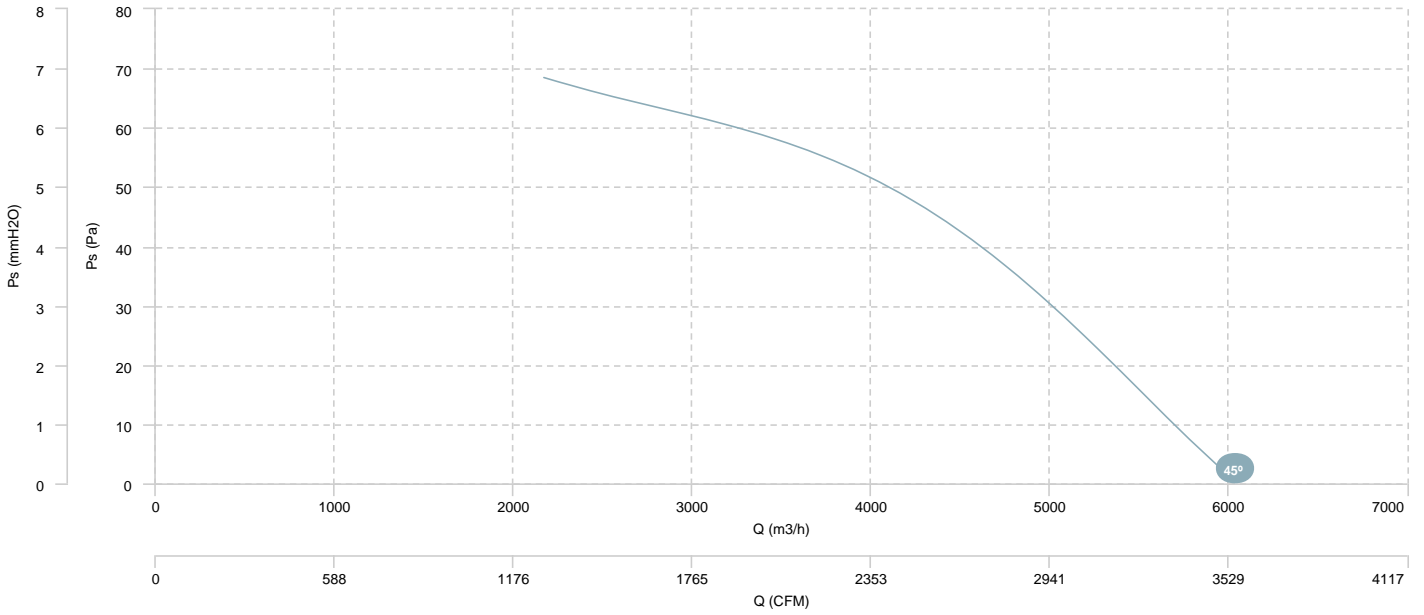

AIR FLOW - ABSORBED POWER

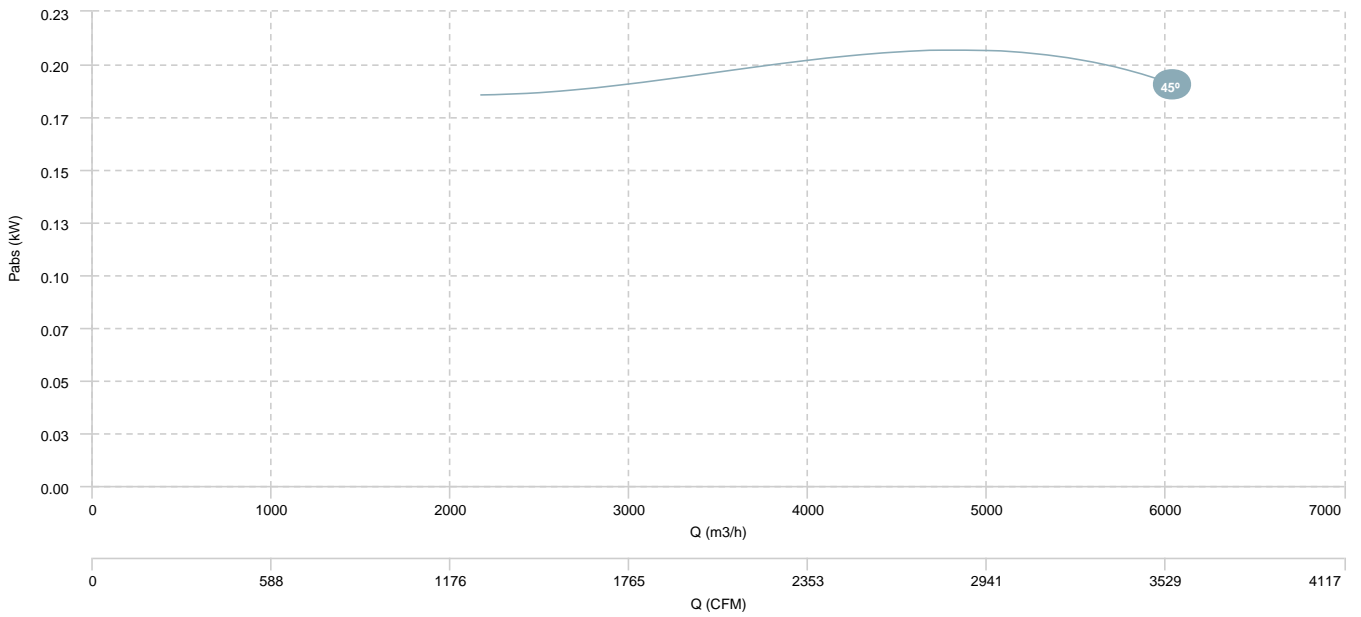

HM 50 T2/T4 1,5/0,37kW (A9:8)	HM 50 T2/T4 2,2/0,55kW (A9:8)	HM 50 T2/T4 3/0,75kW (A9:8)
HM 50 T2/T4 4,5/0,9kW (A9:8)		

## AIR FLOW - PRESSURE (2 poles)

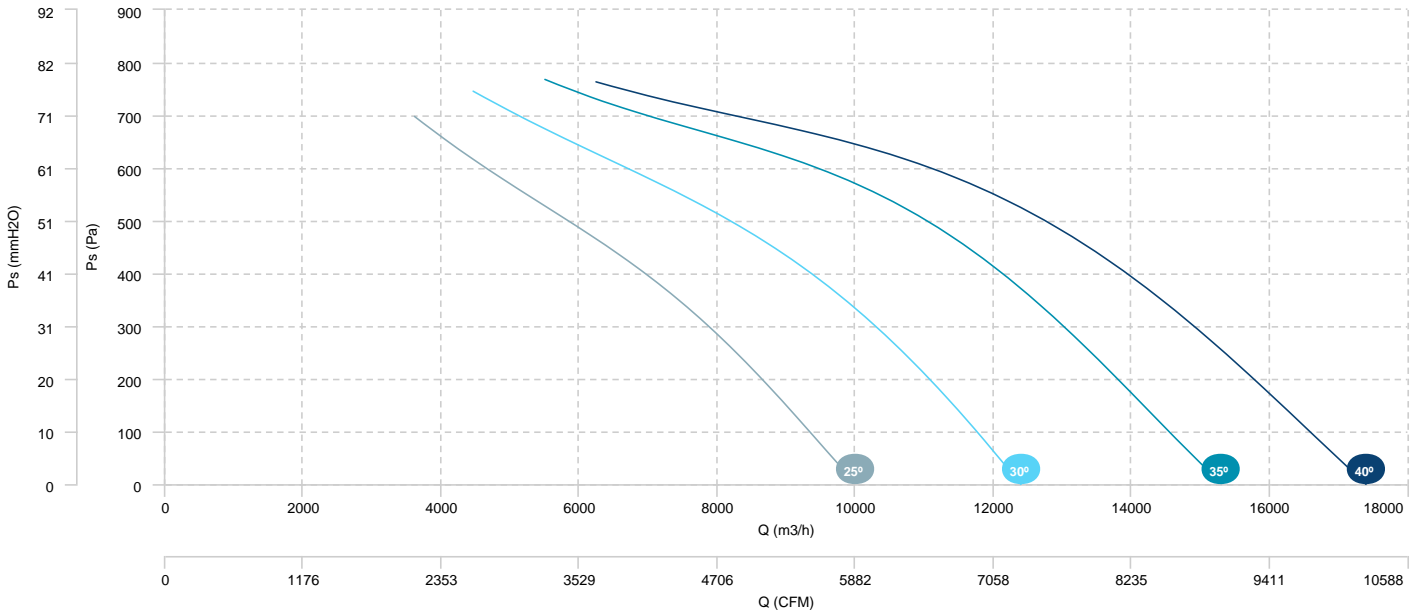

## AIR FLOW - ABSORBED POWER (2 poles)

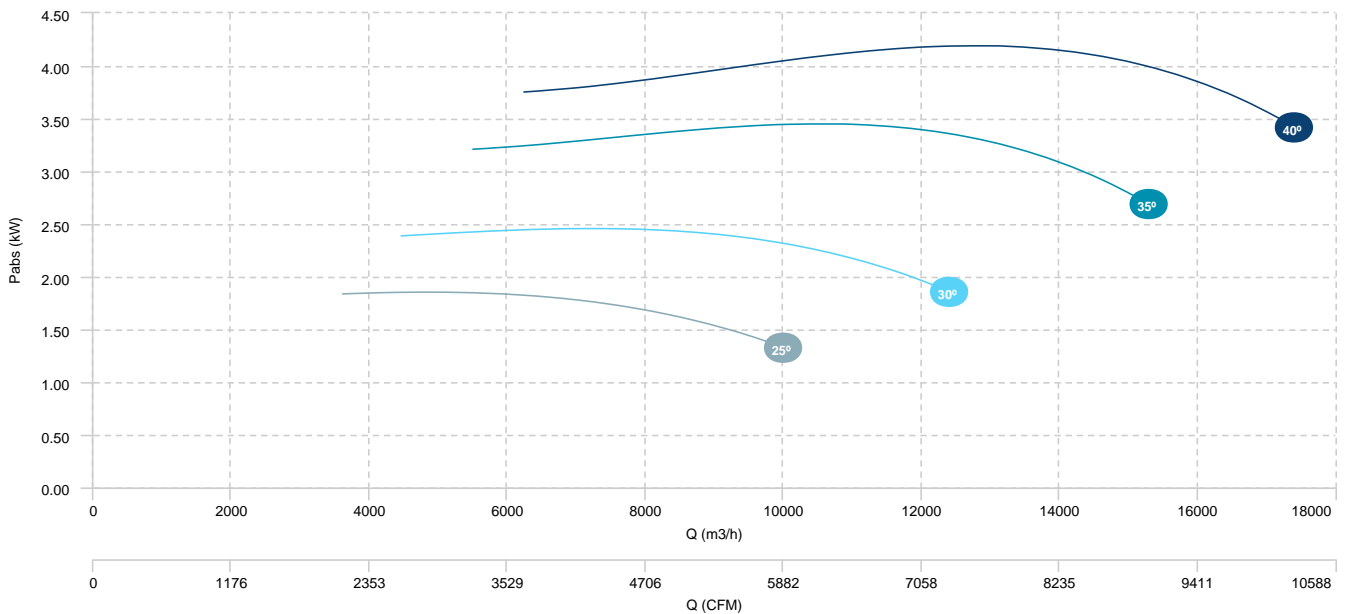

HM 50 T2/T4 1,5/0,37kW (A9:8)	HM 50 T2/T4 2,2/0,55kW (A9:8)	HM 50 T2/T4 3/0,75kW (A9:8)
HM 50 T2/T4 4,5/0,9kW (A9:8)		

## AIR FLOW - PRESSURE (4 poles)

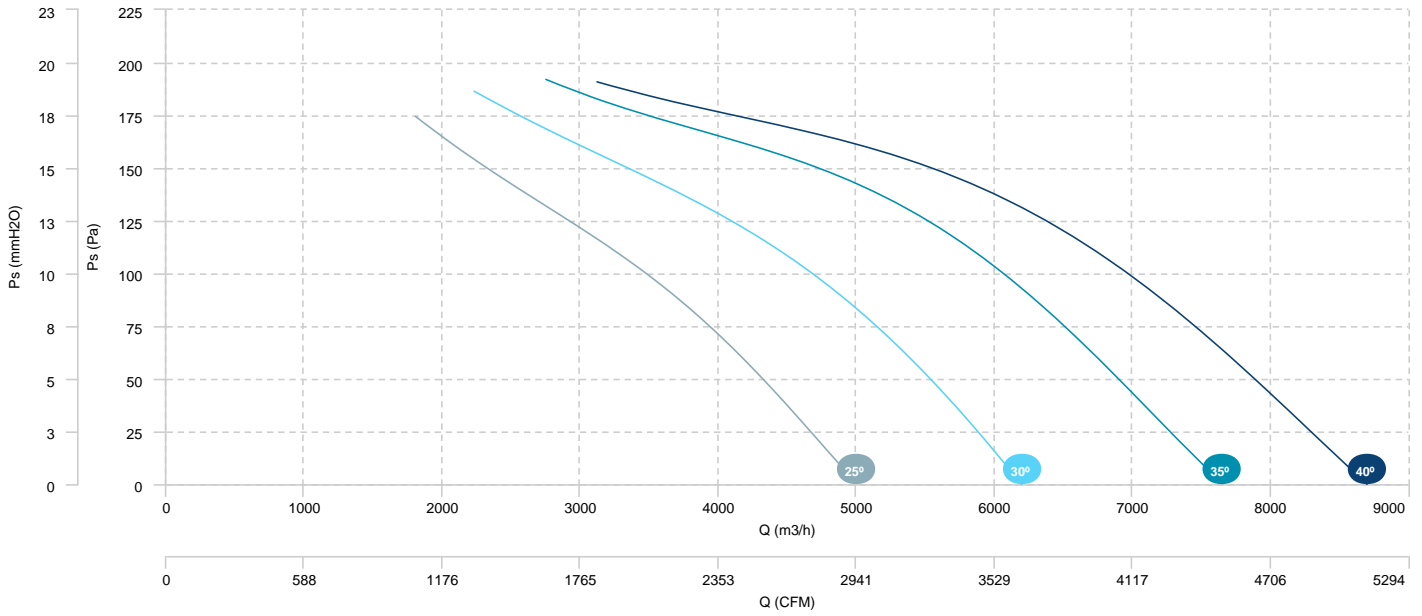

HM 50 T2/T4 1,1/0,25kW (A9:4)	HM 50 T2/T4 1,5/0,37kW (A9:4)	HM 50 T2/T4 2,2/0,55kW (A9:4)
HM 50 T2/T4 3/0,75kW (A9:4)	HM 50 T2/T4 4,5/0,9kW (A9:4)	

## AIR FLOW - PRESSURE (2 poles)

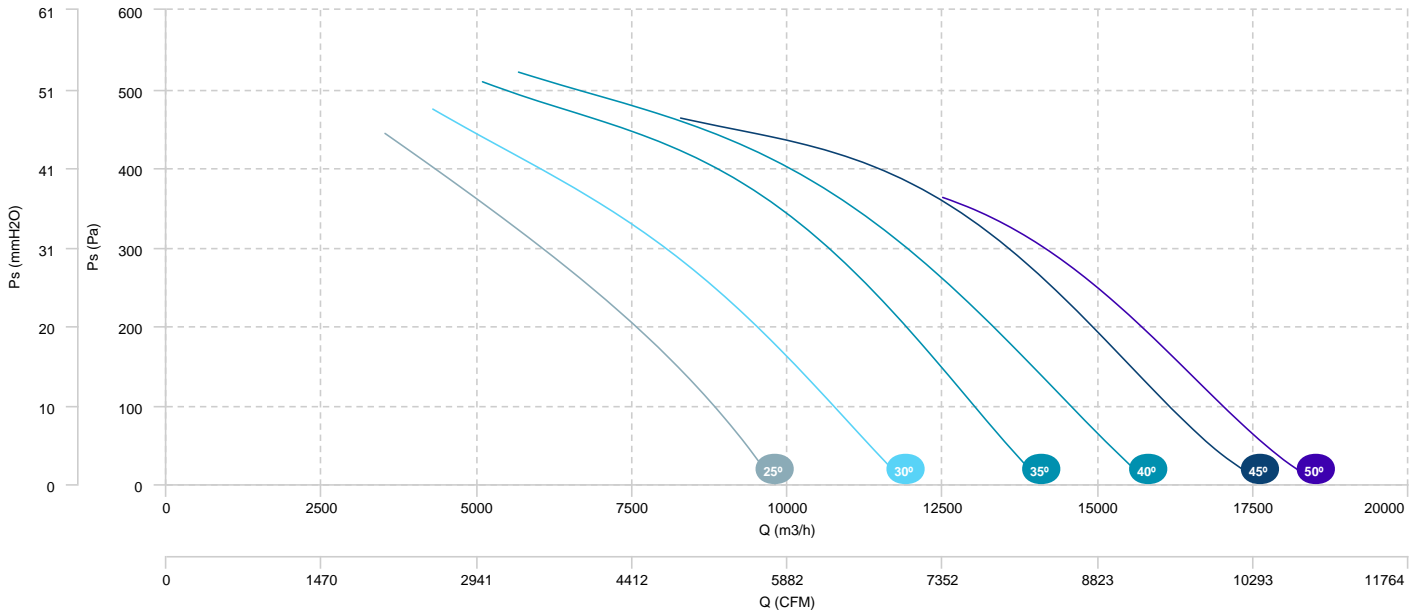

## AIR FLOW - ABSORBED POWER (2 poles)

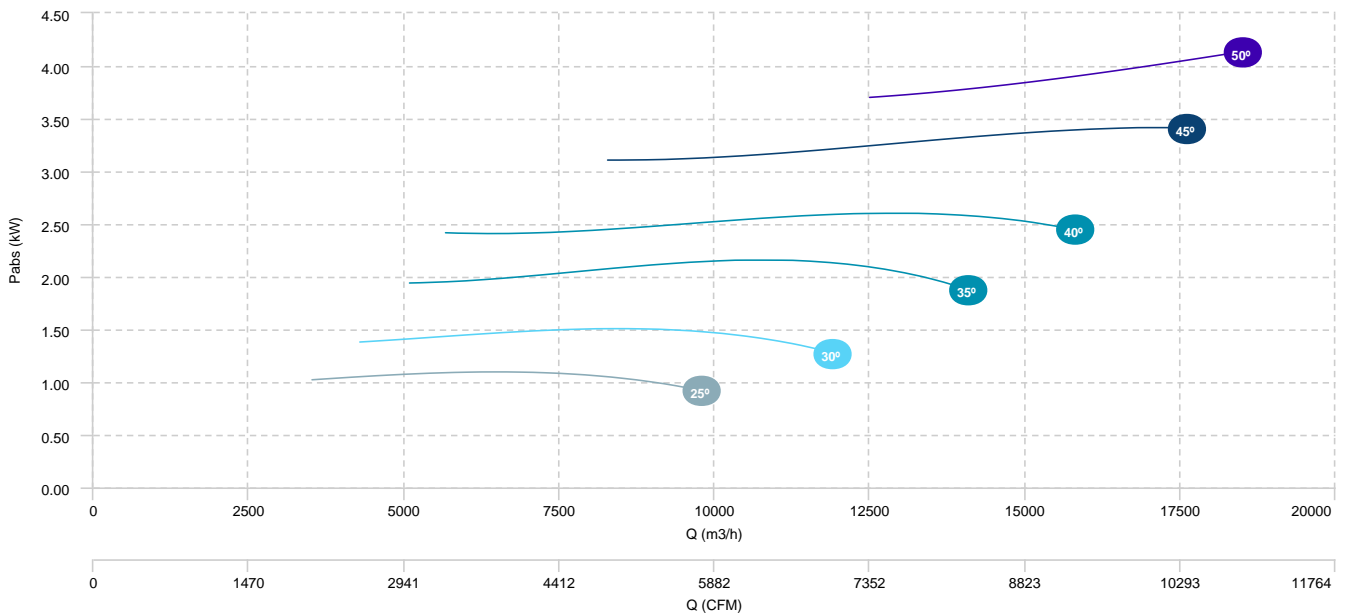

HM 50 T2/T4 1,1/0,25kW (A9:4)	HM 50 T2/T4 1,5/0,37kW (A9:4)	HM 50 T2/T4 2,2/0,55kW (A9:4)
HM 50 T2/T4 3/0,75kW (A9:4)	HM 50 T2/T4 4,5/0,9kW (A9:4)	

## AIR FLOW - PRESSURE (4 poles)

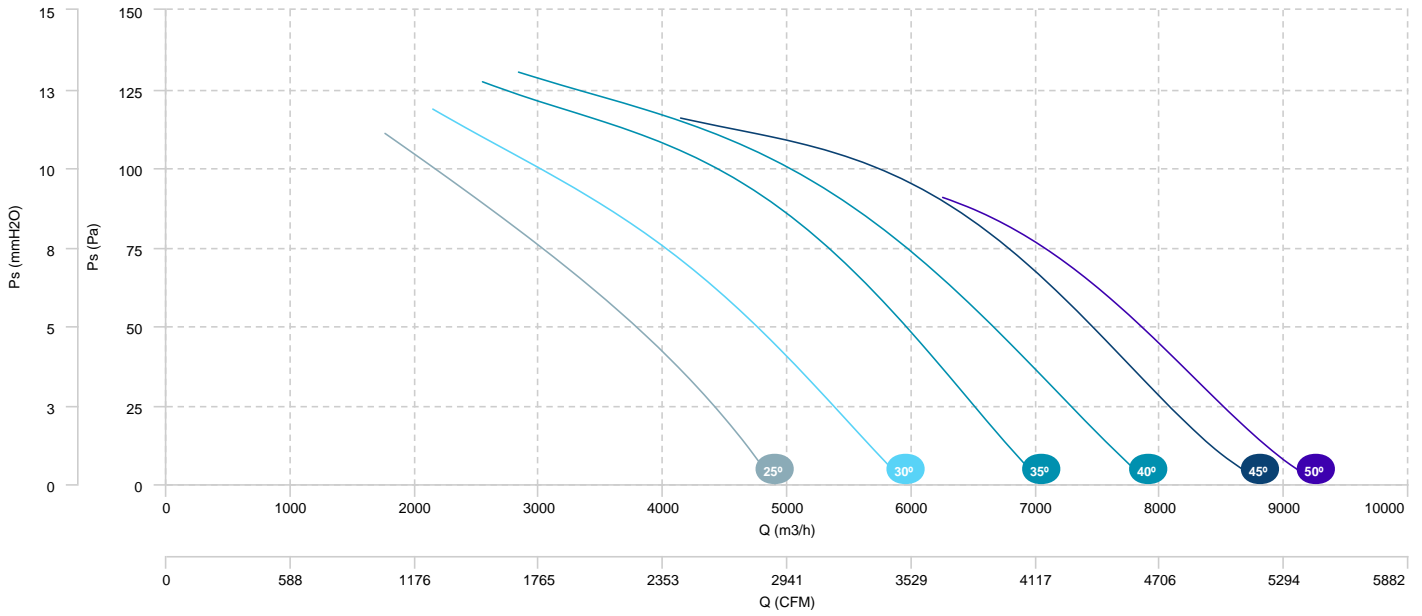

HM 50 T4/T6 0,55/0,18kW (A0:6)

AIR FLOW - PRESSURE (4 poles)

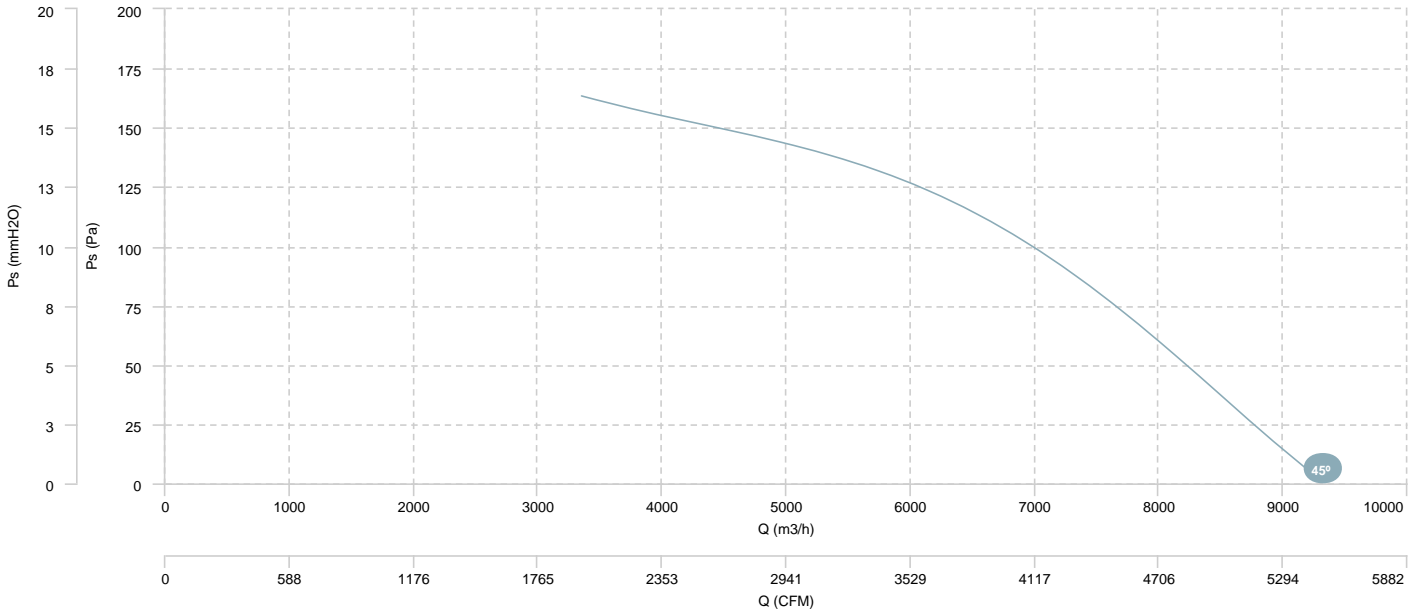

AIR FLOW - ABSORBED POWER (4 poles)

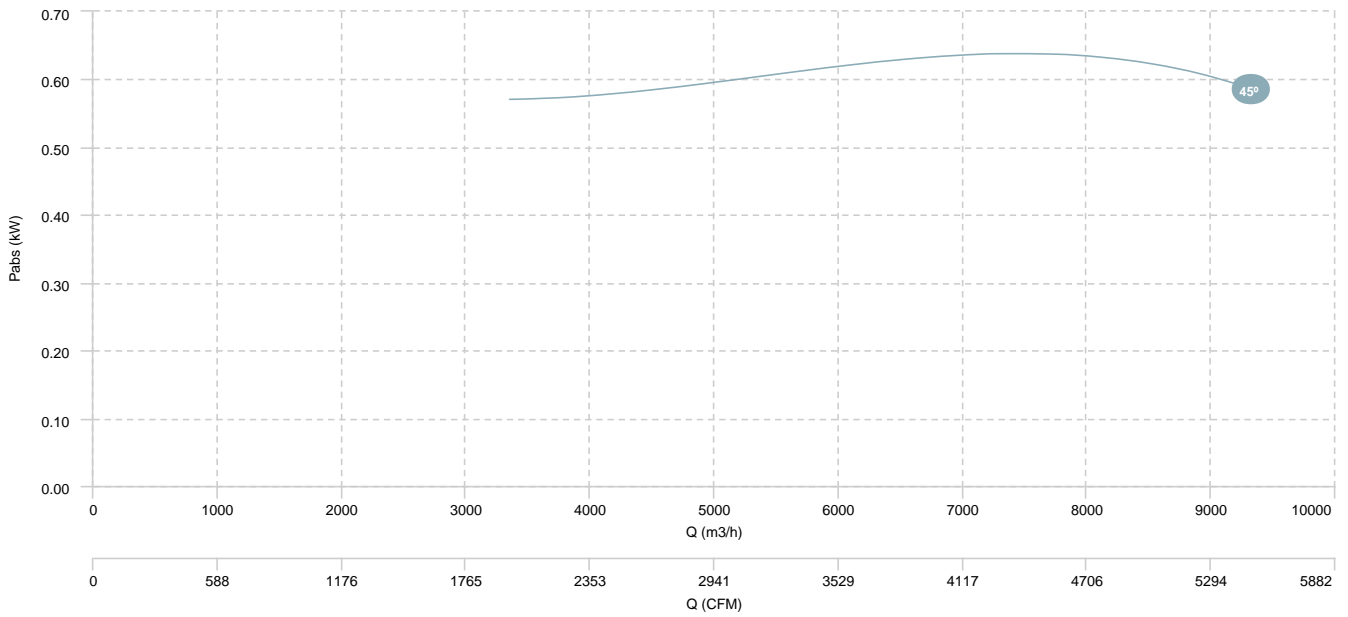



HM 50 T4/T6 0,55/0,18kW (A0:6)

AIR FLOW - PRESSURE (6 poles)

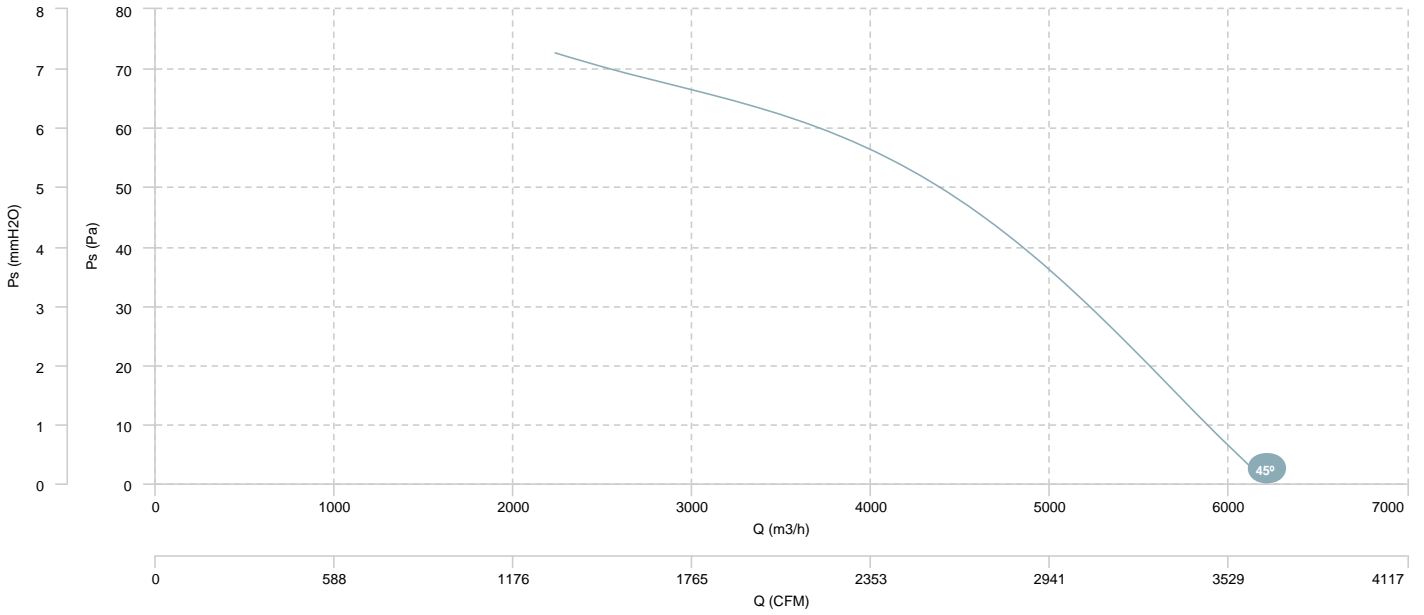

HM 50 T4/T8 0,55/0,09kW (A0:6)

AIR FLOW - PRESSURE (4 poles)

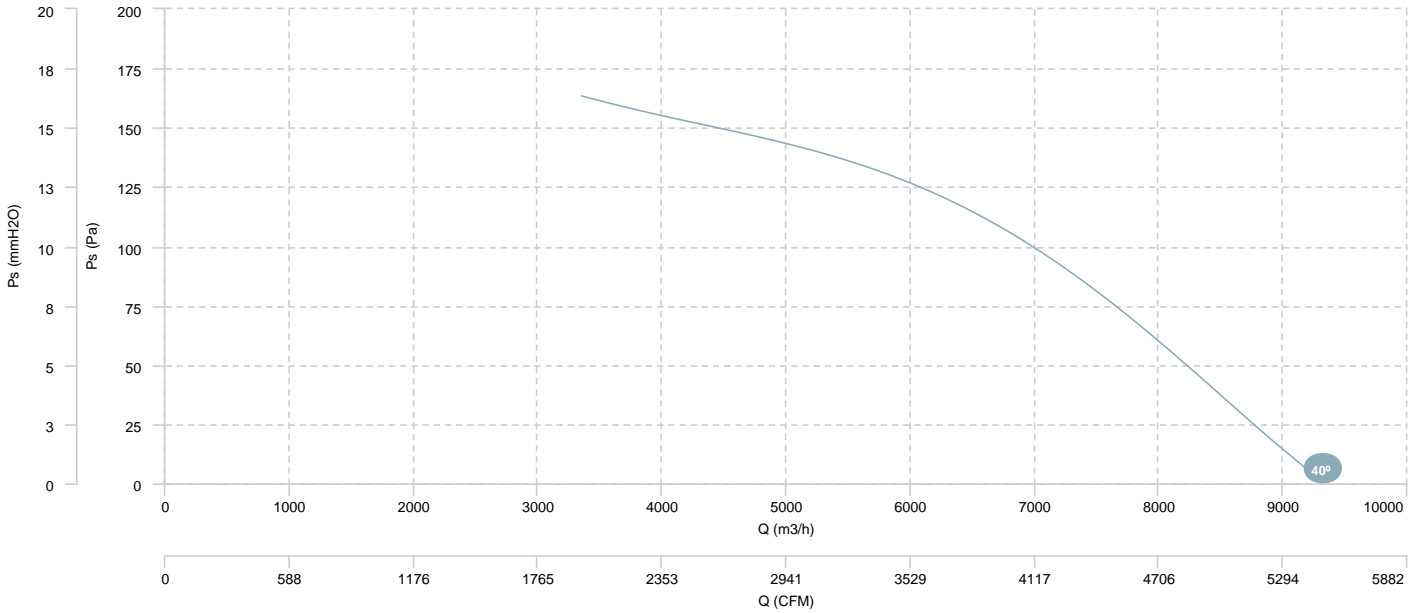

AIR FLOW - ABSORBED POWER (4 poles)

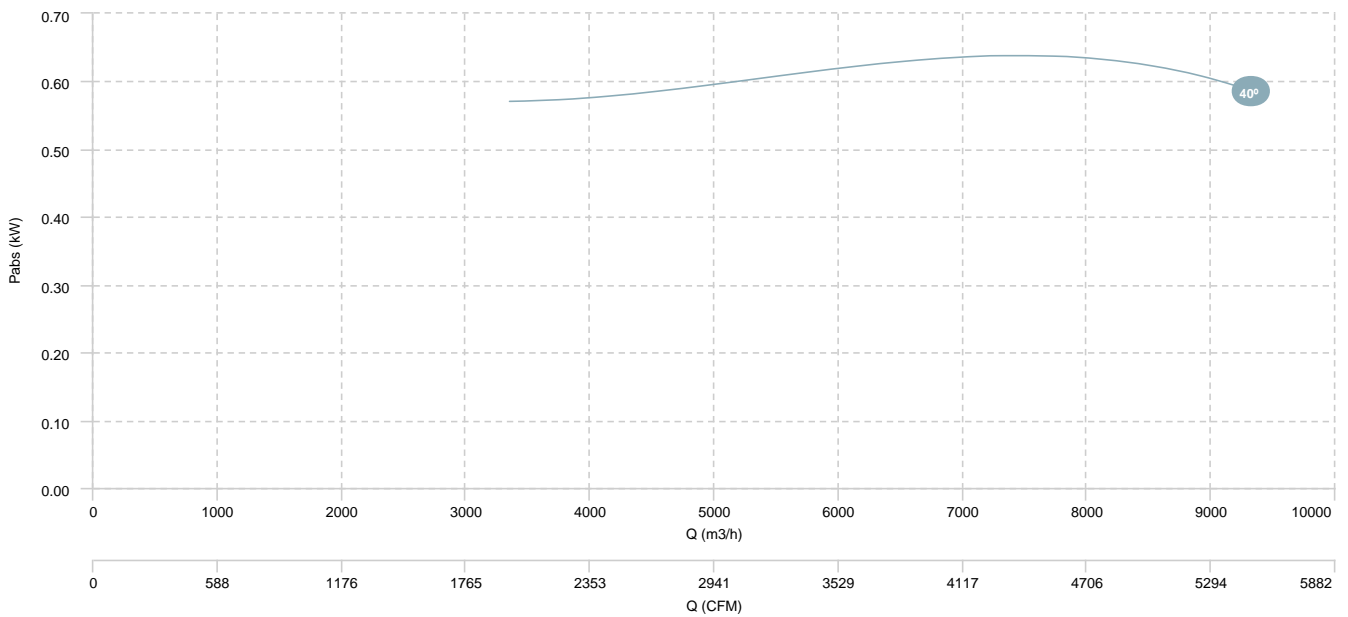

HM 50 T4/T8 0,55/0,09kW (A0:6)

AIR FLOW - PRESSURE (8 poles)

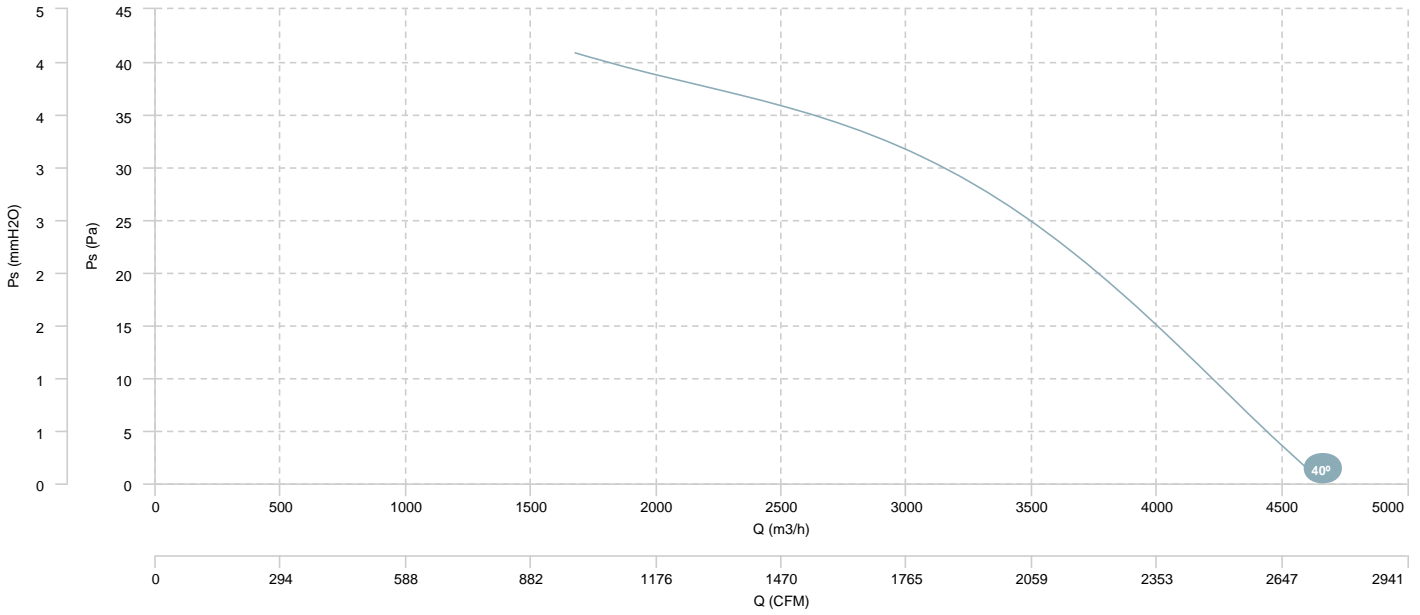

HM 56 T2 2,2kW (A9:8)

HM 56 T2 3kW (A9:8)

HM 56 T2 4kW (A9:8)

AIR FLOW - PRESSURE

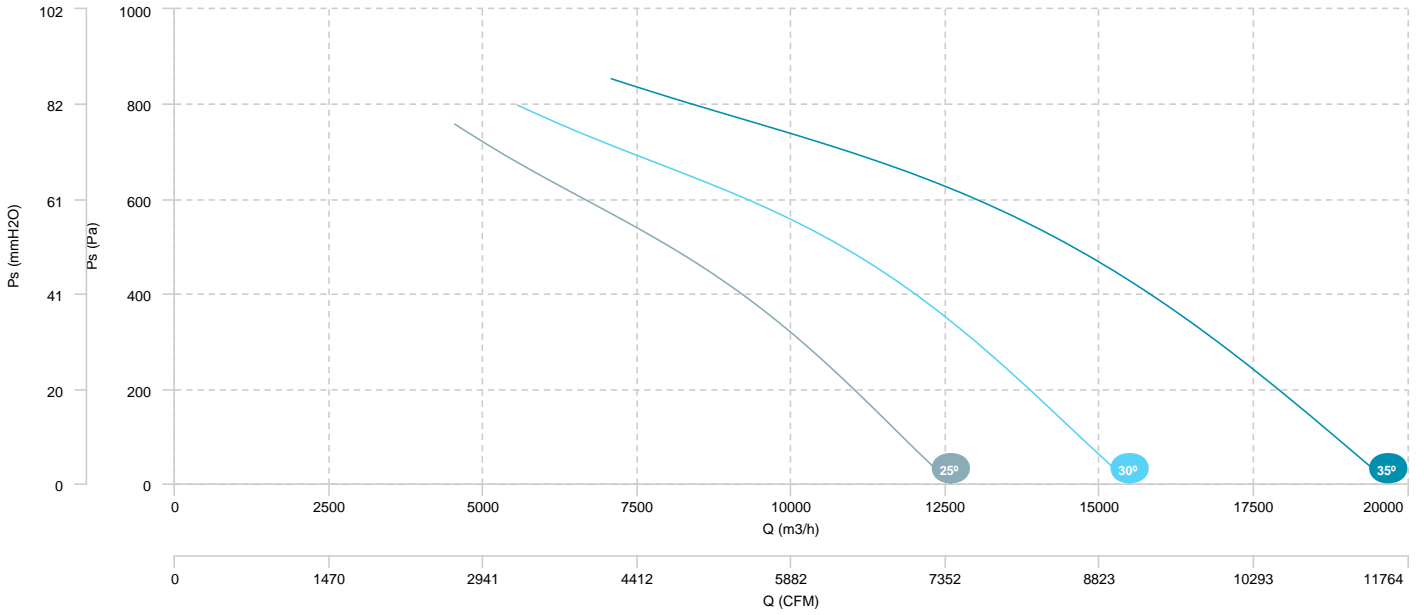

AIR FLOW - ABSORBED POWER

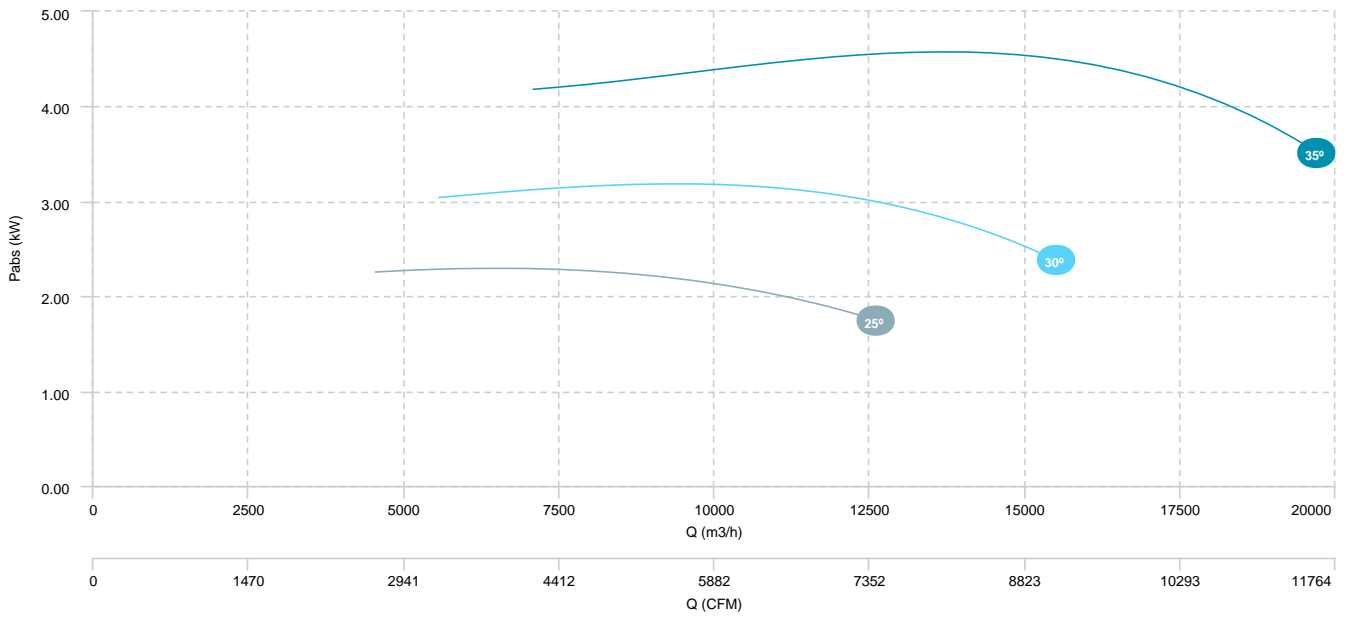

- HM 56 T2 1,5kW (A9:4)
- HM 56 T2 2,2kW (A9:4)
- HM 56 T2 3kW (A9:4)
- HM 56 T2 4kW (A9:4)

## AIR FLOW - PRESSURE

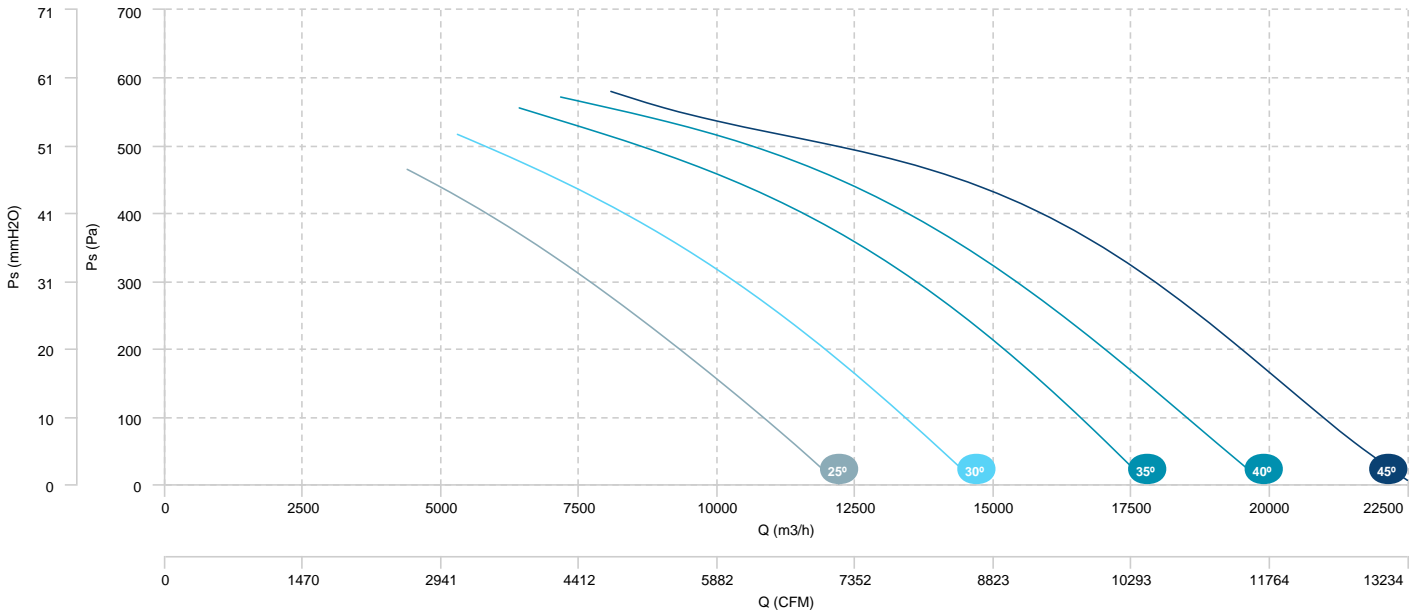

## AIR FLOW - ABSORBED POWER

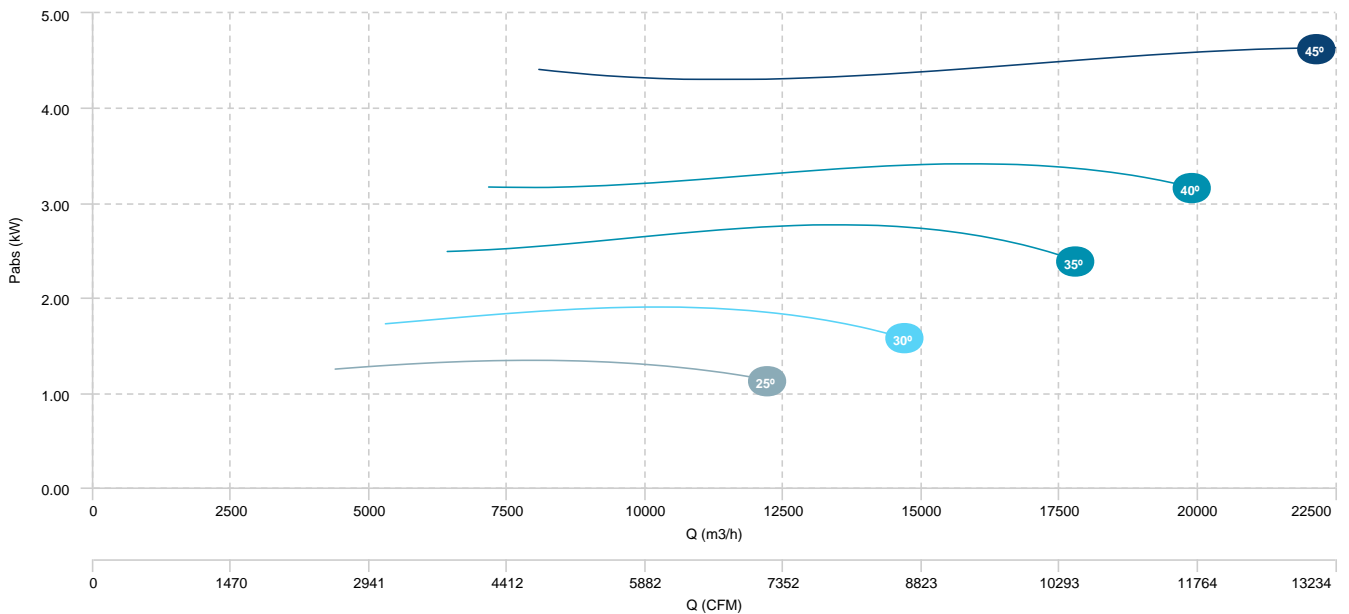

HM 56 T2 5,5kW (A9:10)

HM 56 T2 7,5kW (A9:10)

AIR FLOW - PRESSURE

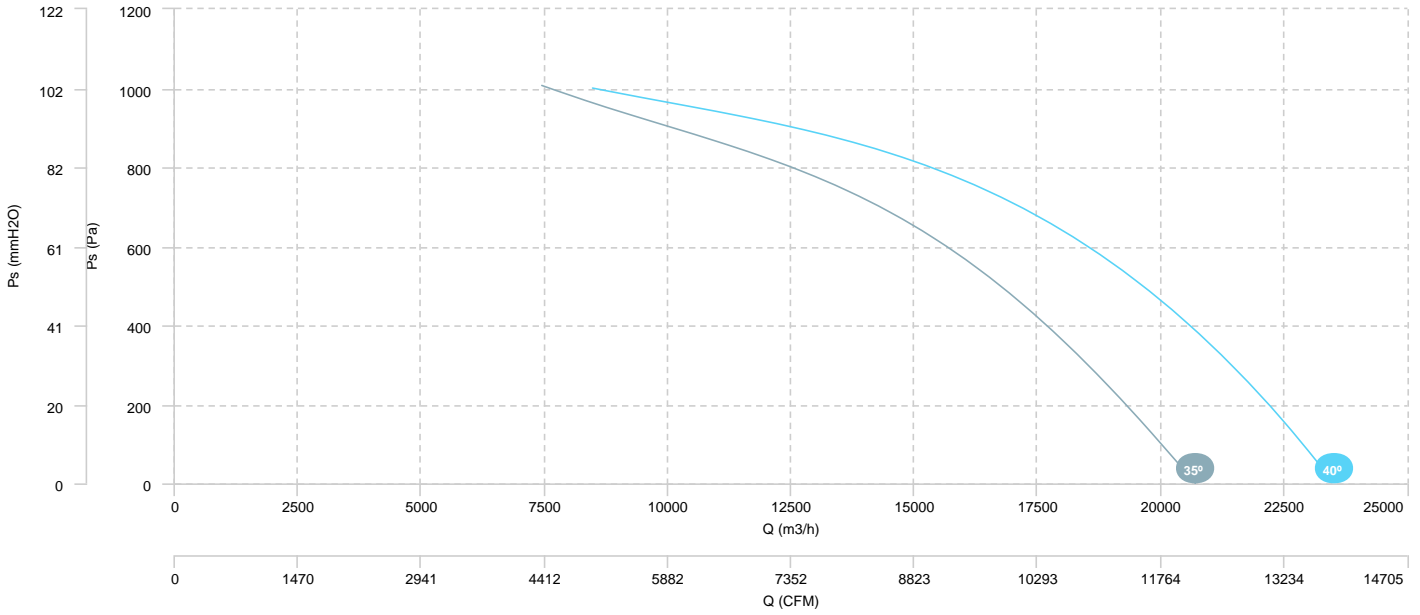

AIR FLOW - ABSORBED POWER

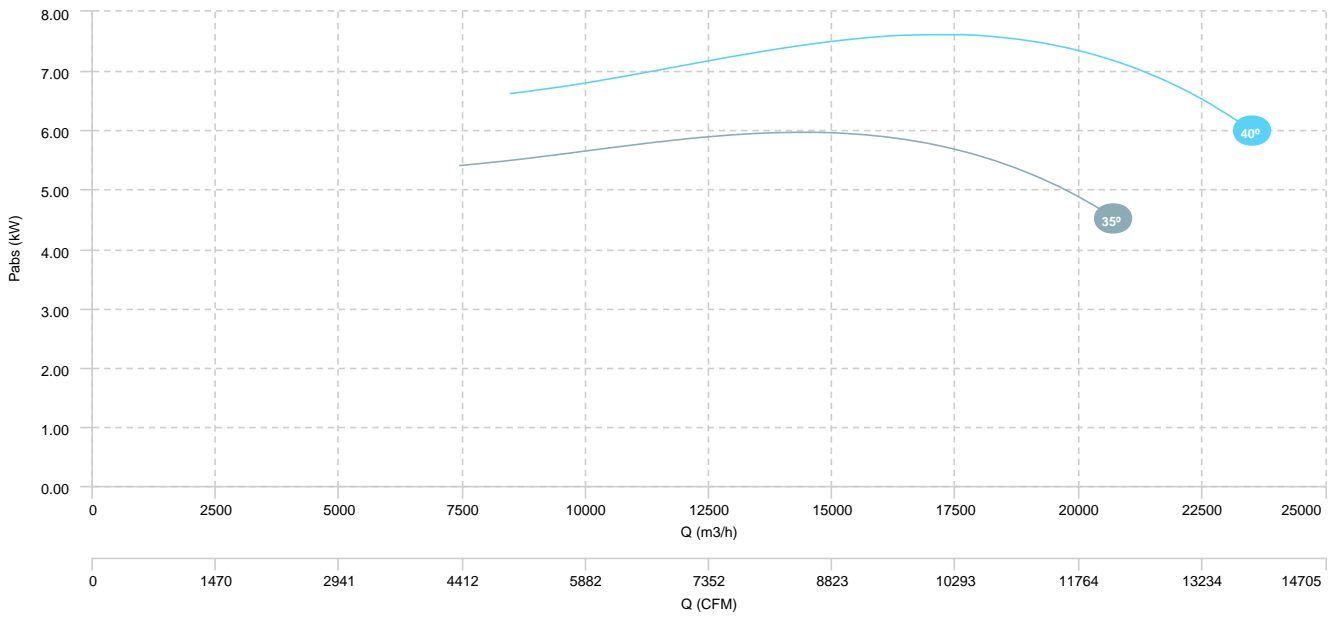

HM 56 T2 5,5kW (A9:5)

AIR FLOW - PRESSURE

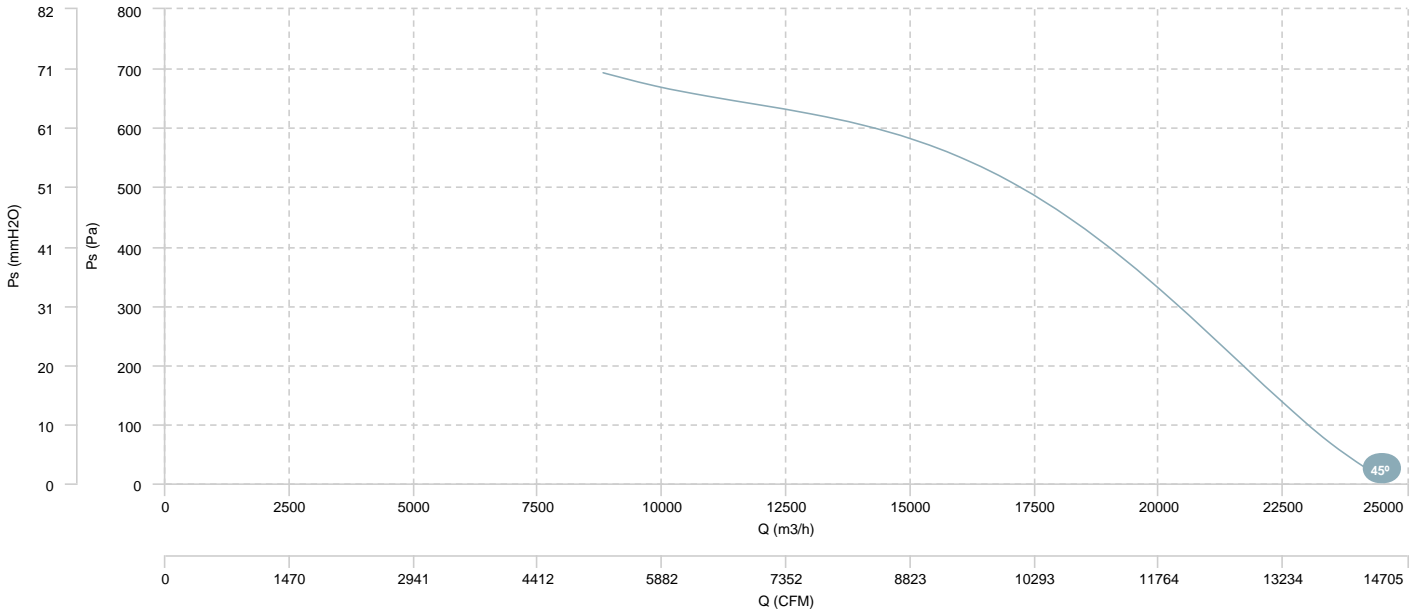

AIR FLOW - ABSORBED POWER

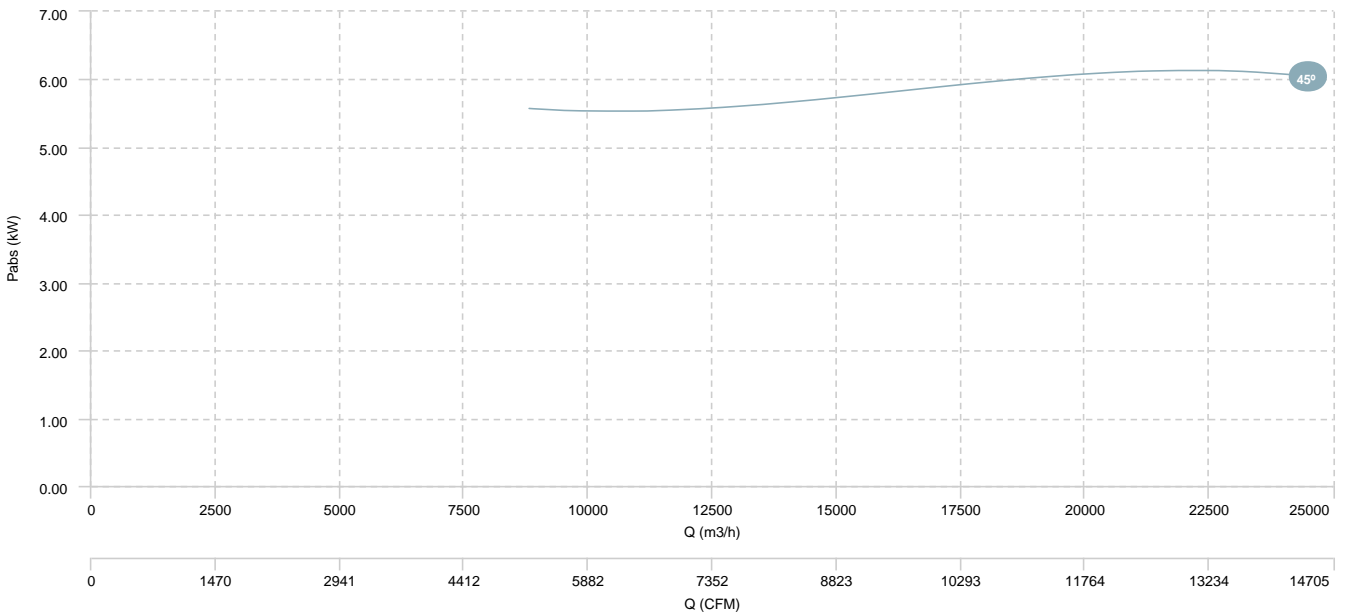

HM 56 T4 0,55kW (A2:9)	HM 56 T4 0,75kW (A2:9)	HM 56 T4 1,1kW (A2:9)
HM 56 T4 1,5kW (A2:9)		

## AIR FLOW - PRESSURE

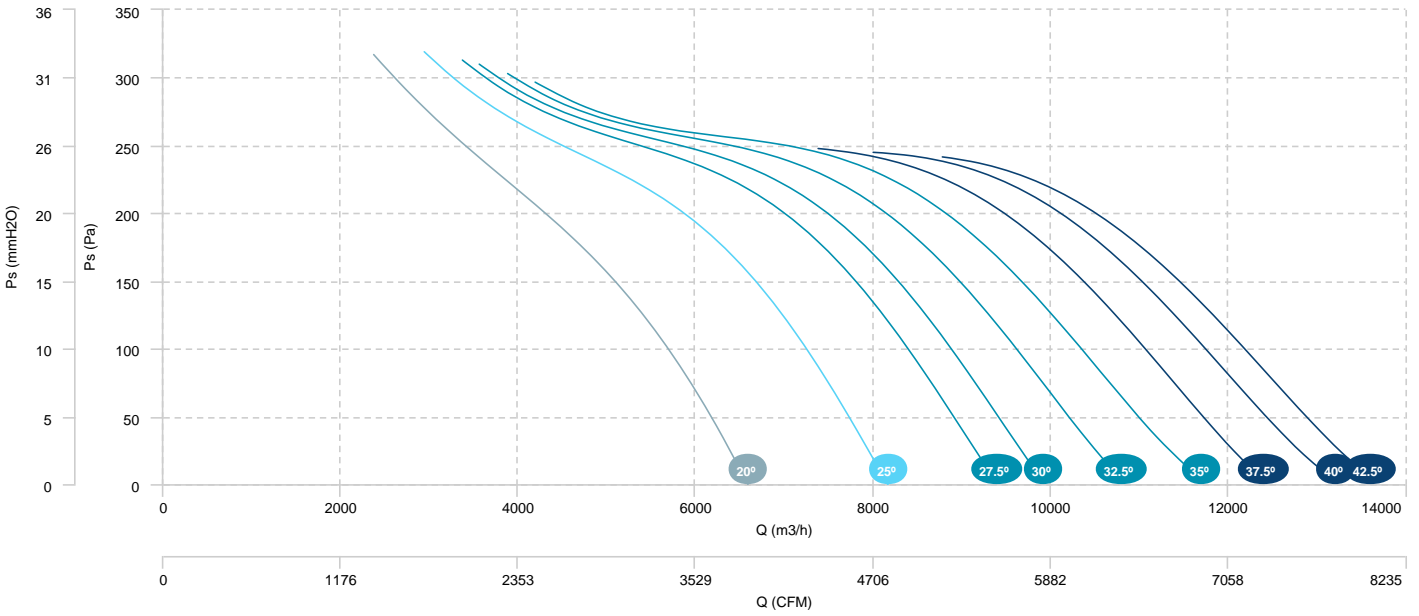

## AIR FLOW - ABSORBED POWER

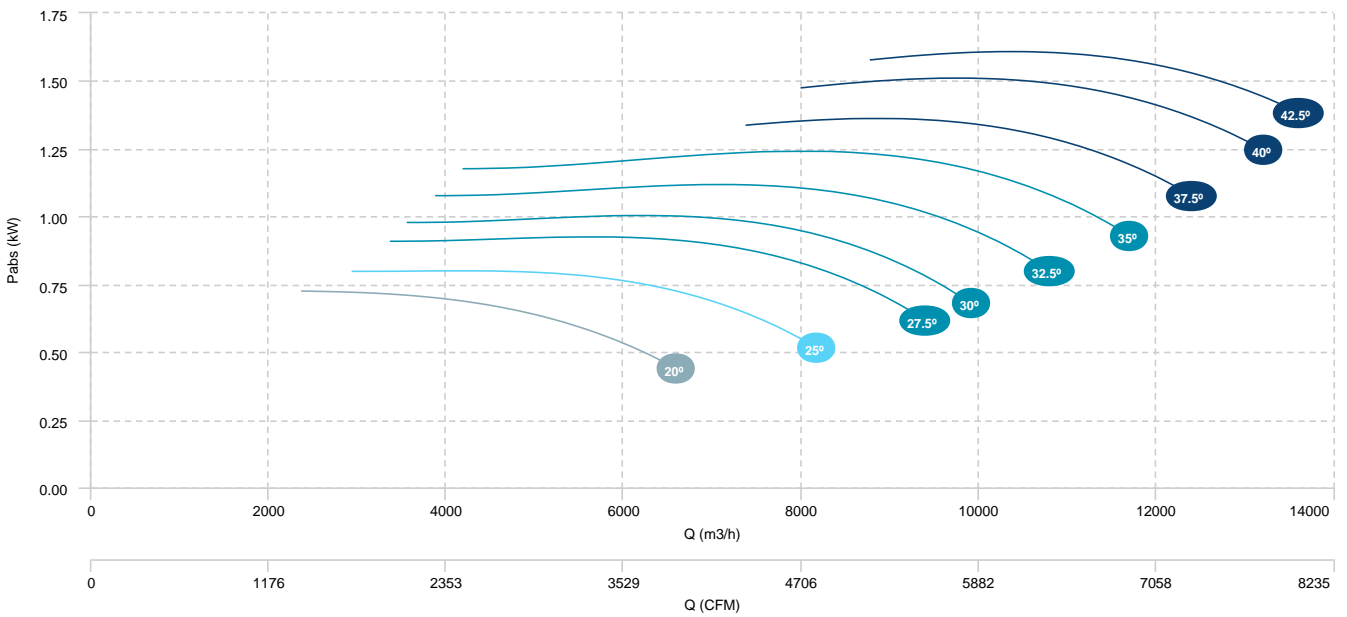



HM 56 T4 0,37kW (A5:6)	HM 56 T4 0,55kW (A5:6)	HM 56 T4 0,75kW (A5:6)
HM 56 T4 1,1kW (A5:6)	HM 56 T4 1,5kW (A5:6)	

## AIR FLOW - PRESSURE

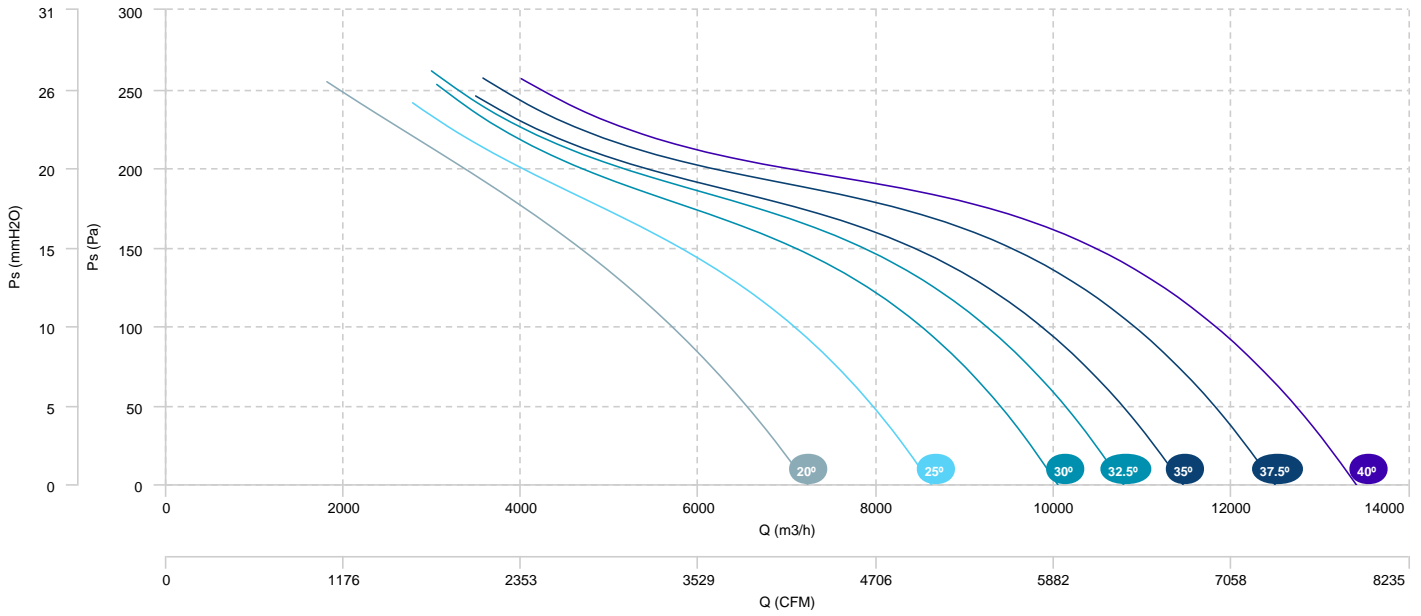

## AIR FLOW - ABSORBED POWER

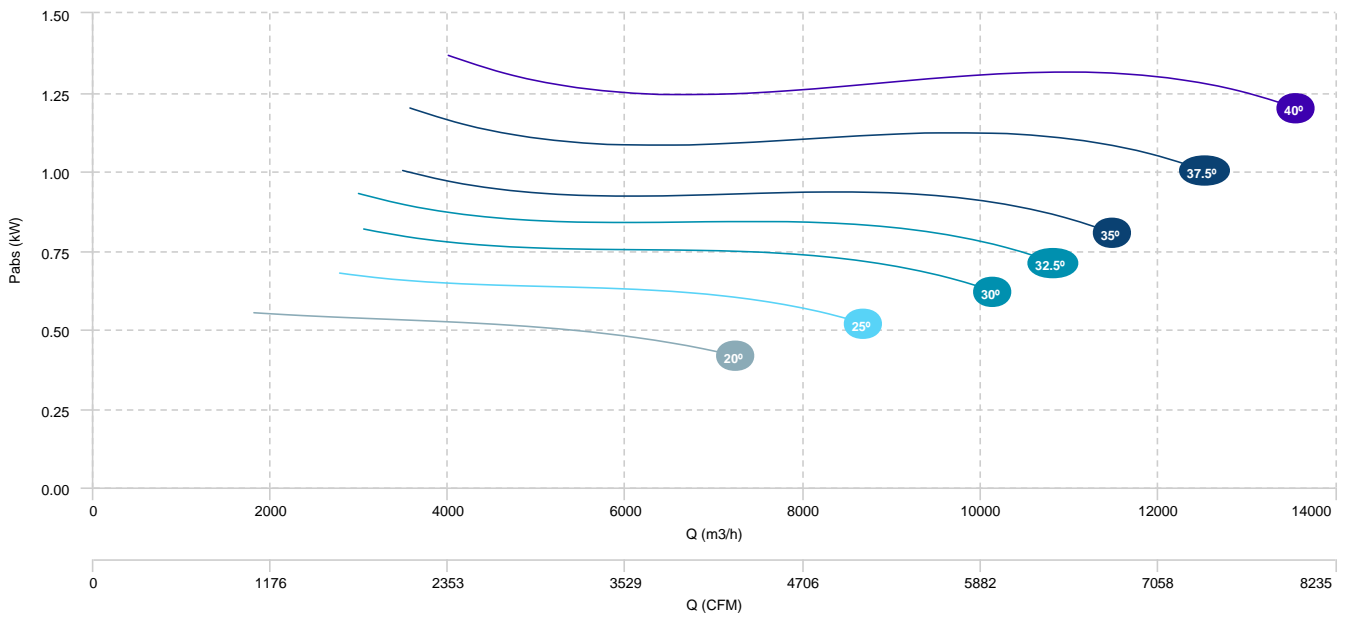

HM 56 T4 0,55kW (A2:6)	HM 56 T4 0,75kW (A2:6)	HM 56 T4 1,1kW (A2:6)
HM 56 T4 1,5kW (A2:6)		

## AIR FLOW - PRESSURE

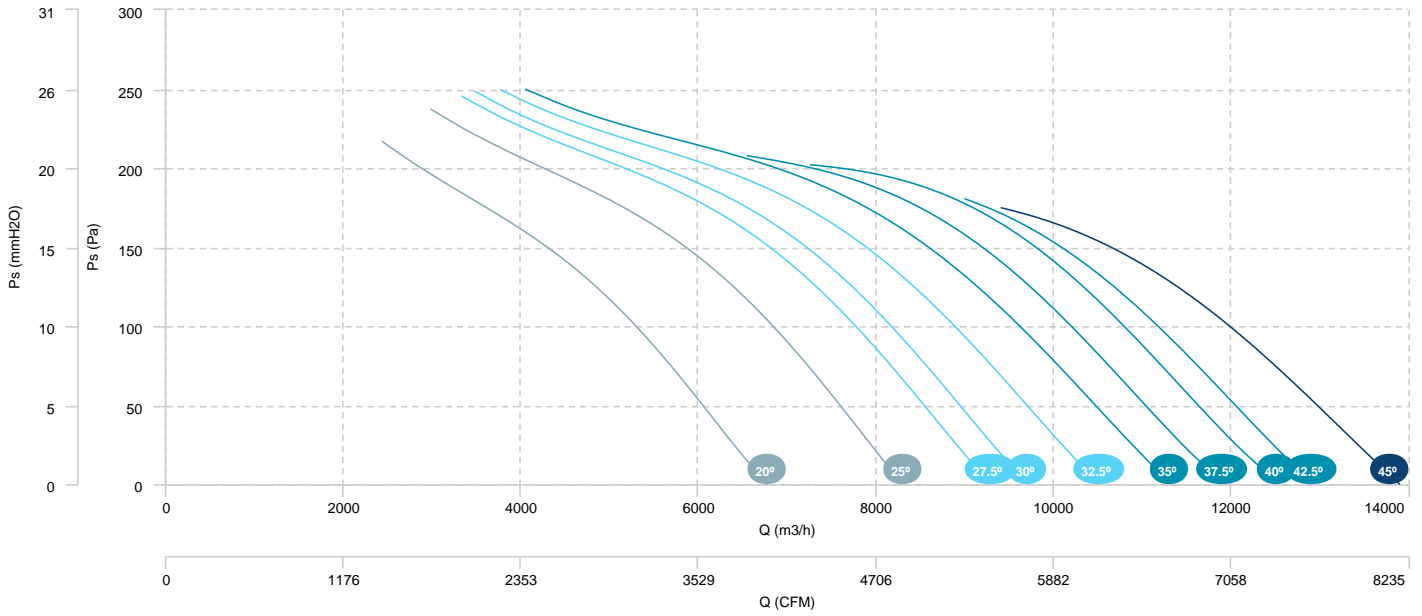

## AIR FLOW - ABSORBED POWER

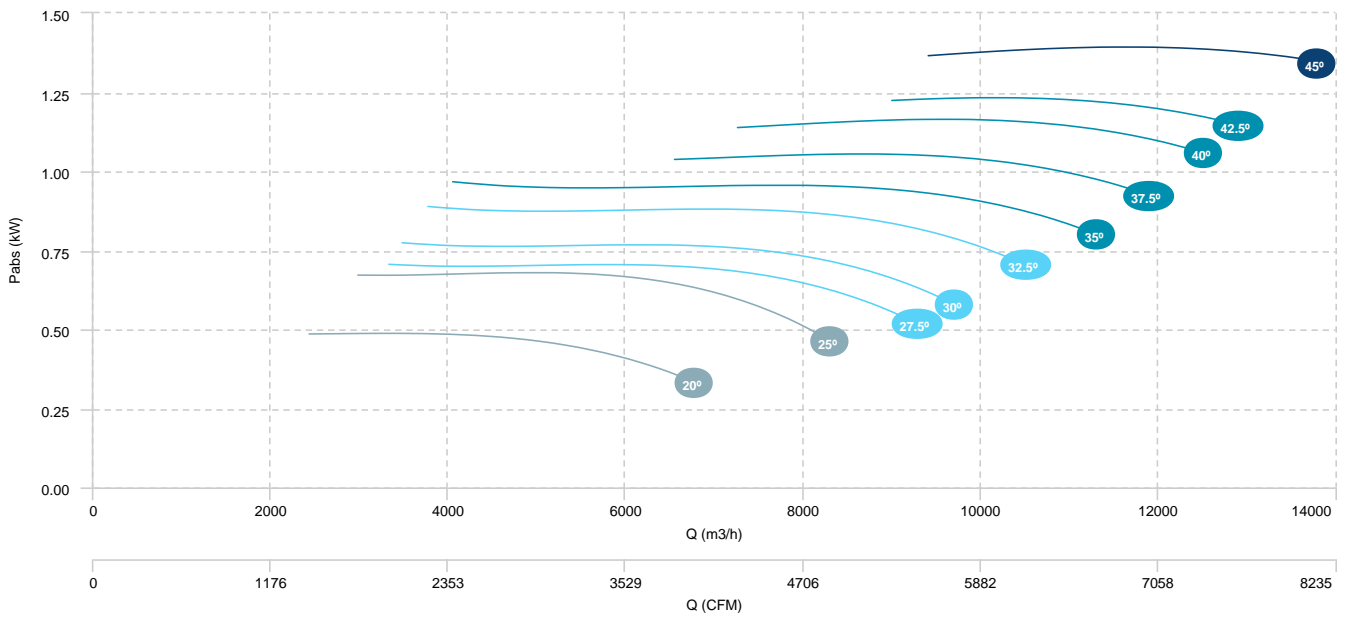

HM 56 T6 0,25kW (A5:6)

HM 56 T6 0,37kW (A5:6)

AIR FLOW - PRESSURE

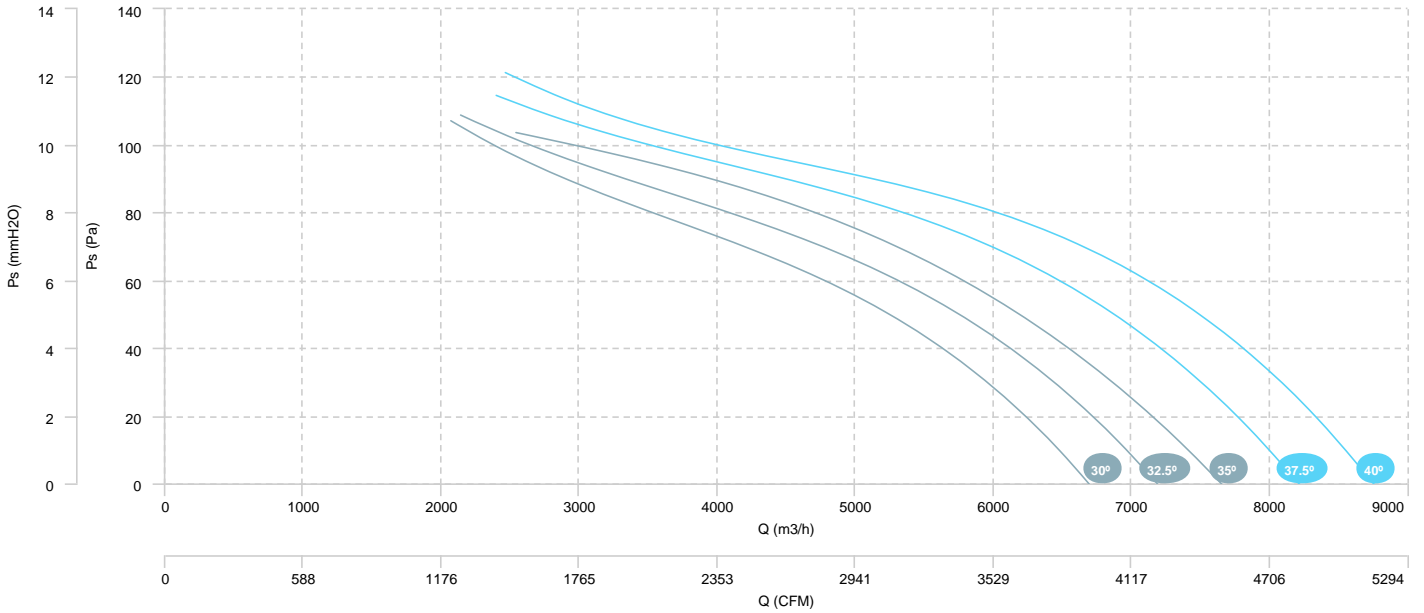

AIR FLOW - ABSORBED POWER

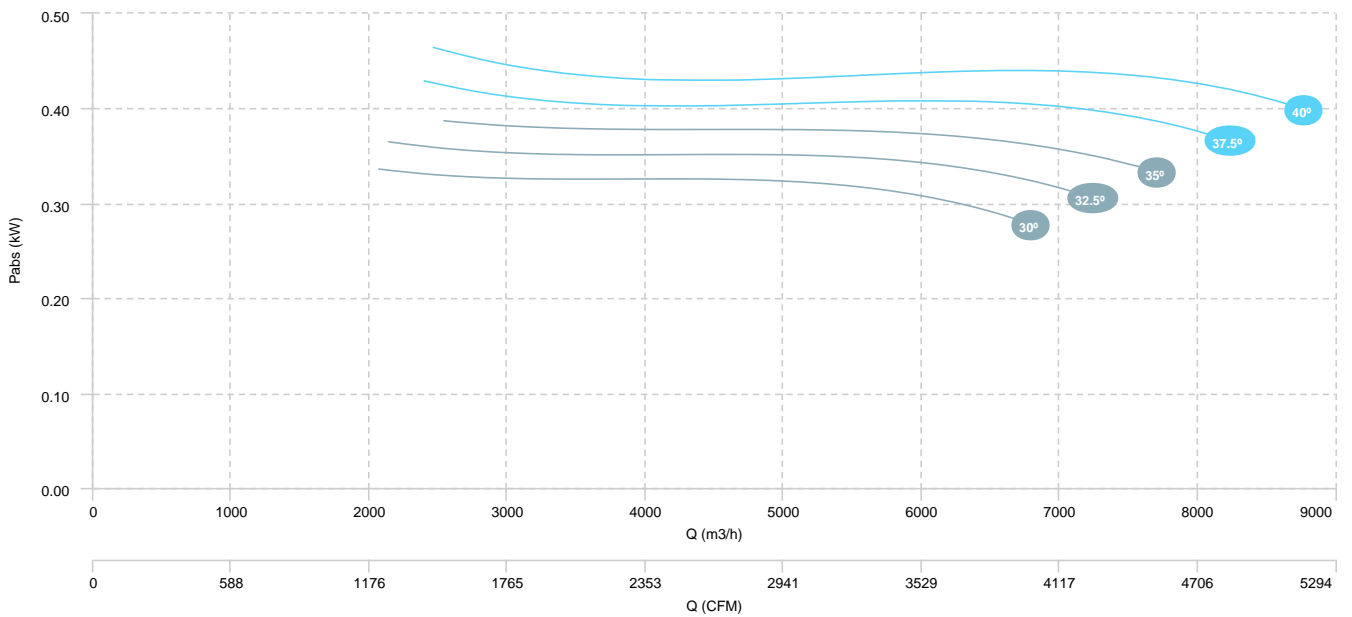

HM 56 T6 0,55kW (A2:9)

AIR FLOW - PRESSURE

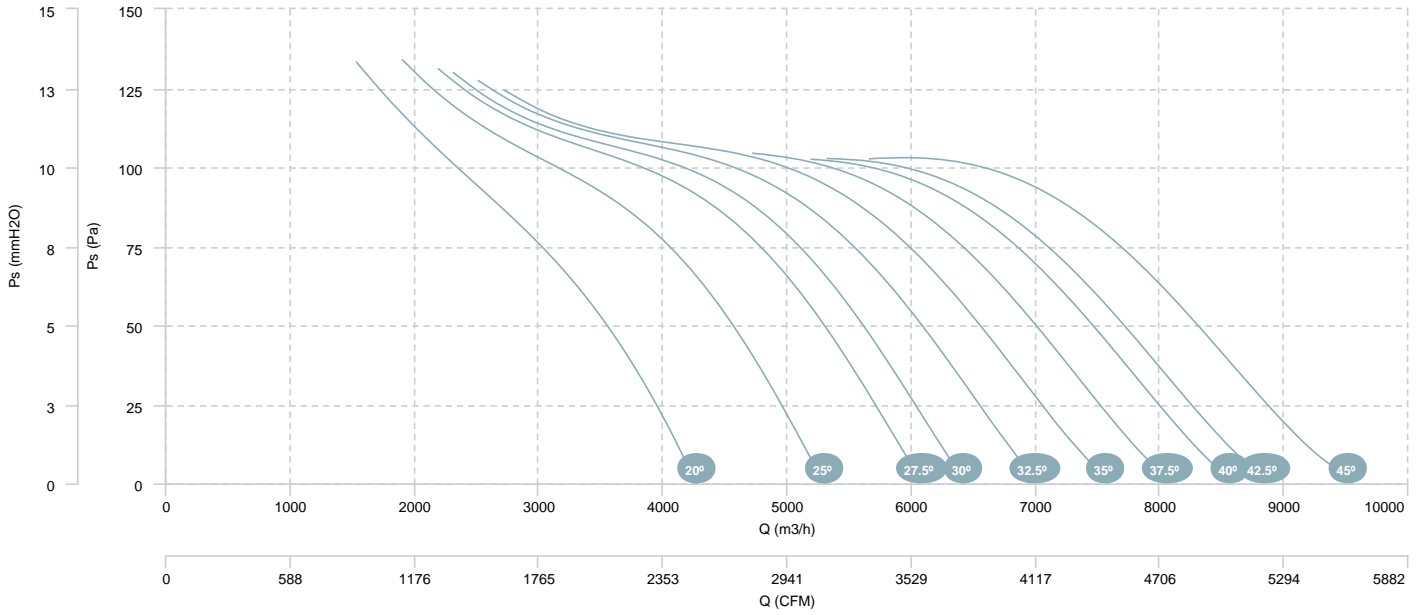

AIR FLOW - ABSORBED POWER

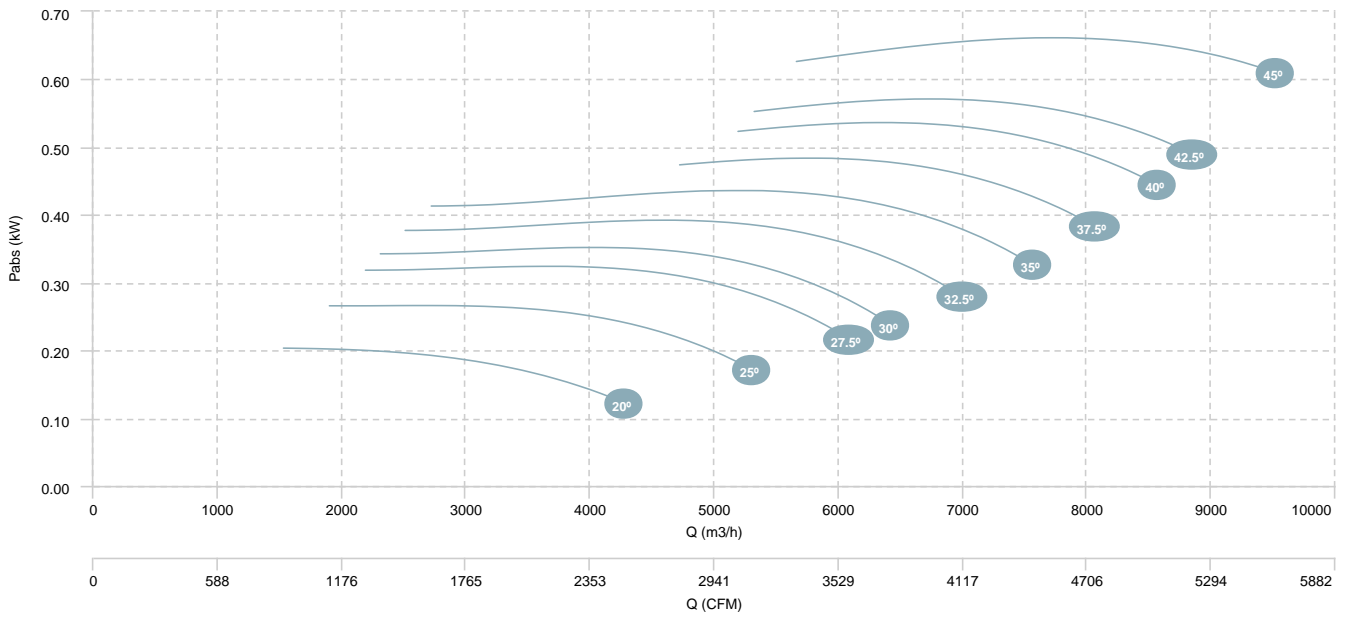

HM 56 T6 0,55kW (A2:6)

AIR FLOW - PRESSURE

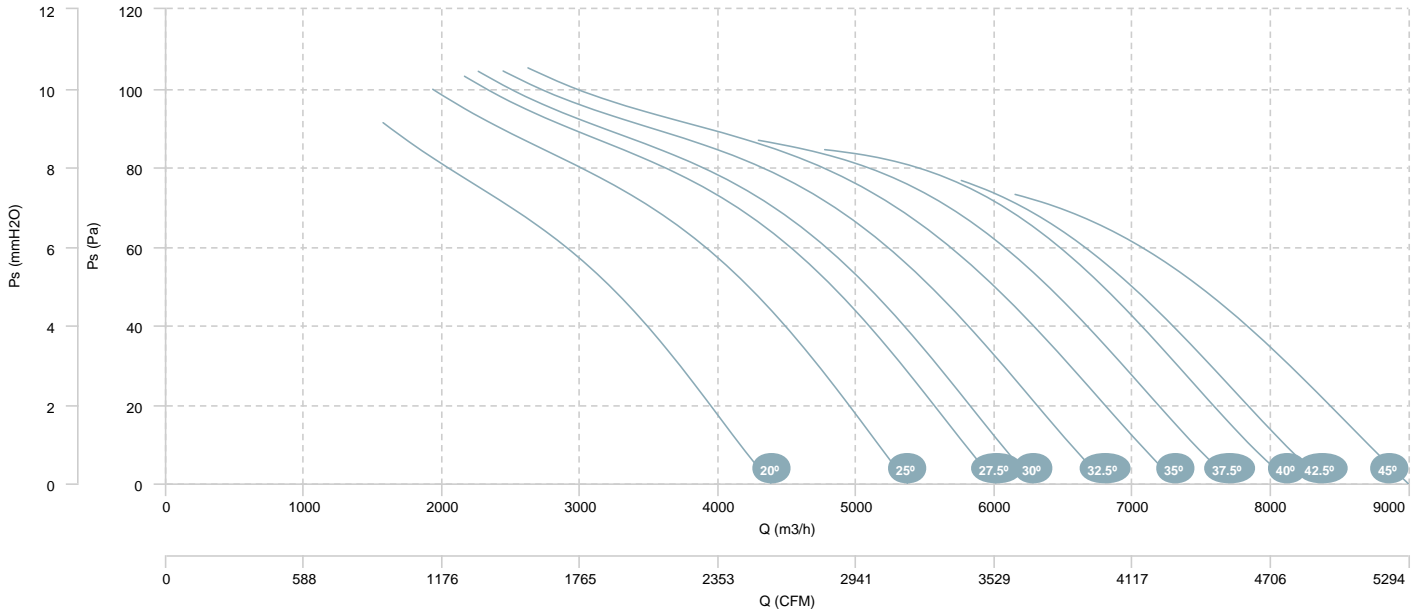

AIR FLOW - ABSORBED POWER

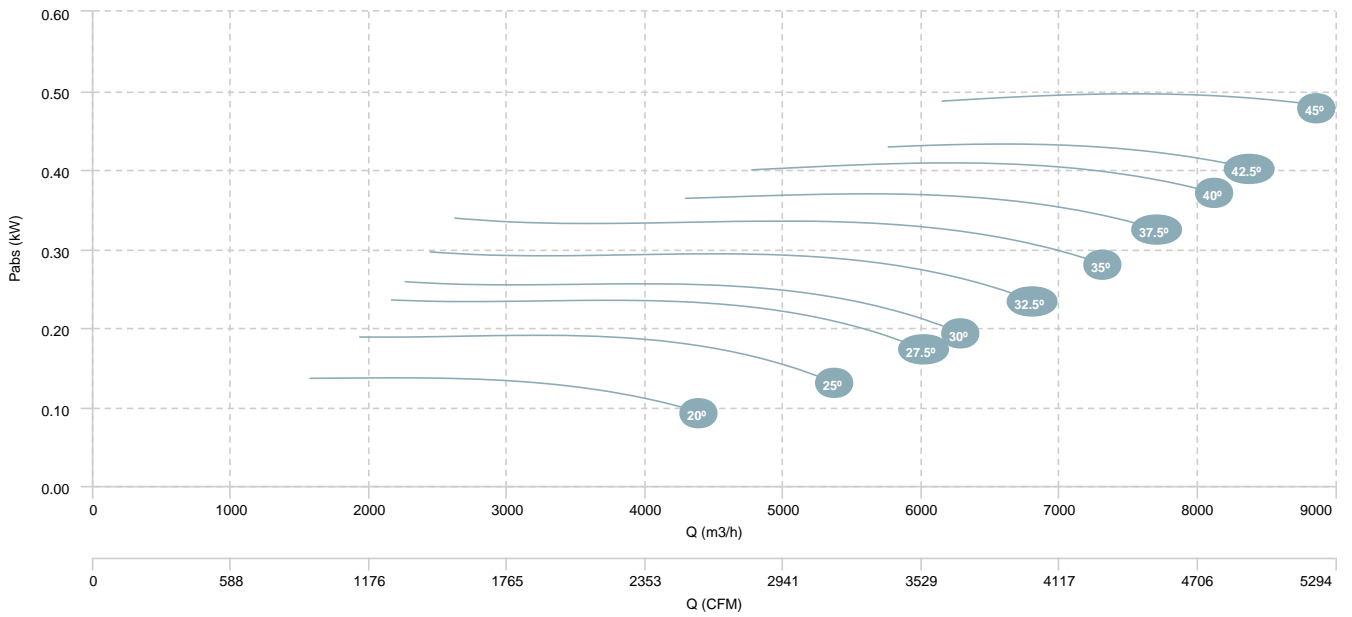

HM 56 T2/T4 5,5/1,5kW (A9:10)

HM 56 T2/T4 8/1,85kW (A9:10)

AIR FLOW - PRESSURE (2 poles)

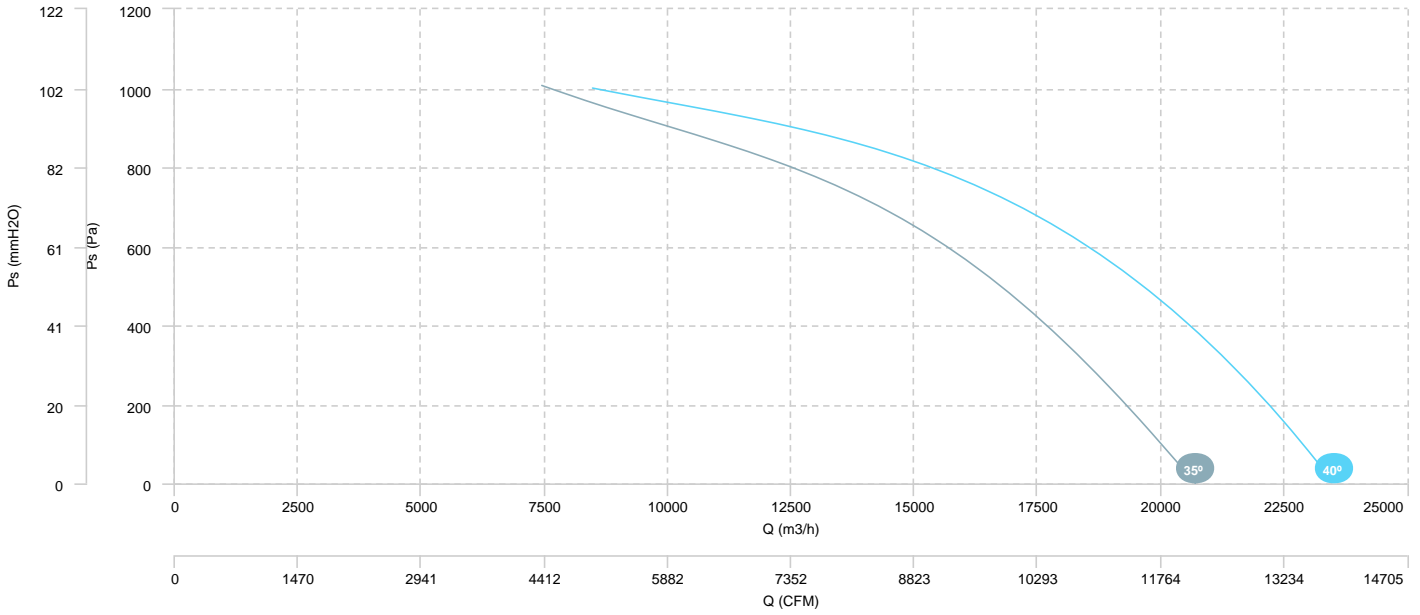

AIR FLOW - ABSORBED POWER (2 poles)

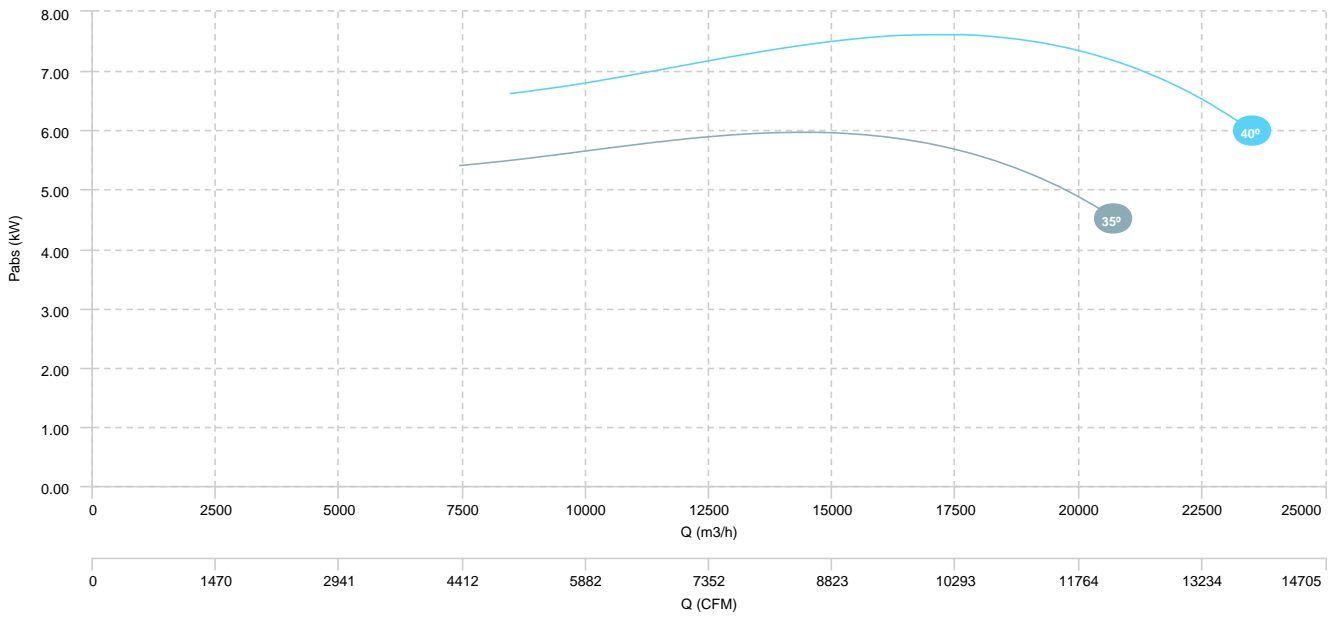

HM 56 T2/T4 5,5/1,5kW (A9:10)

HM 56 T2/T4 8/1,85kW (A9:10)

AIR FLOW - PRESSURE (4 poles)

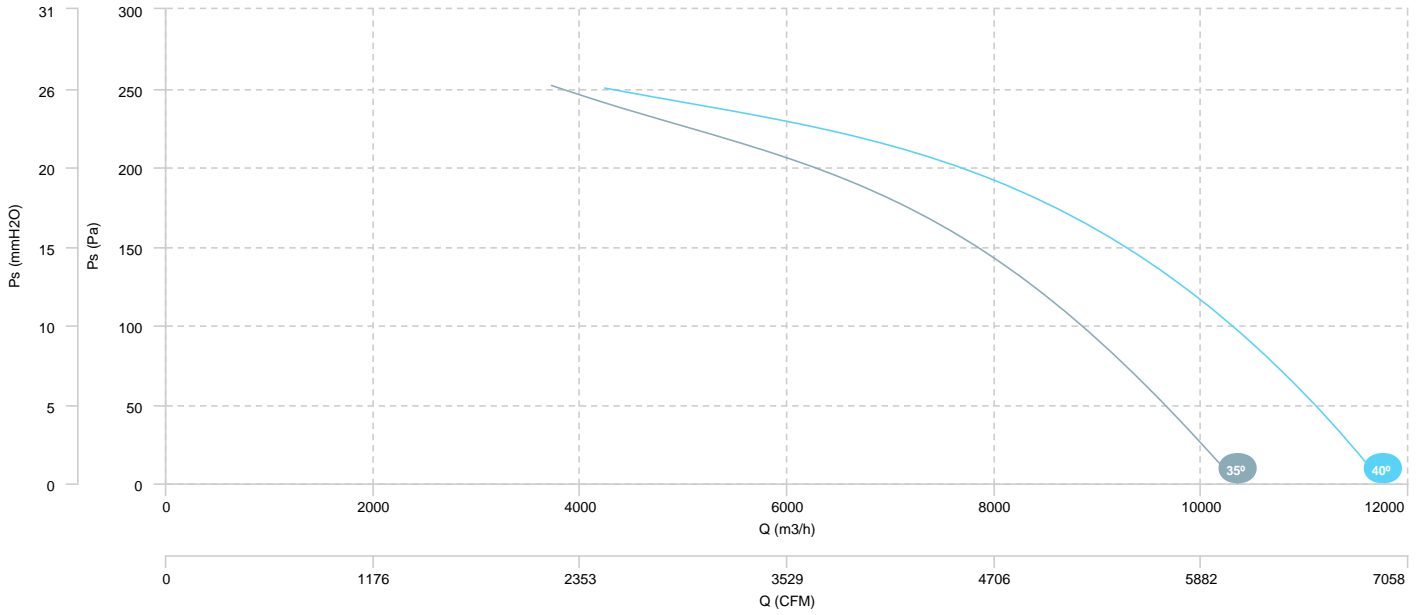

HM 56 T2/T4 5,5/1,5kW (A9:5)

**AIR FLOW - PRESSURE (2 poles)**

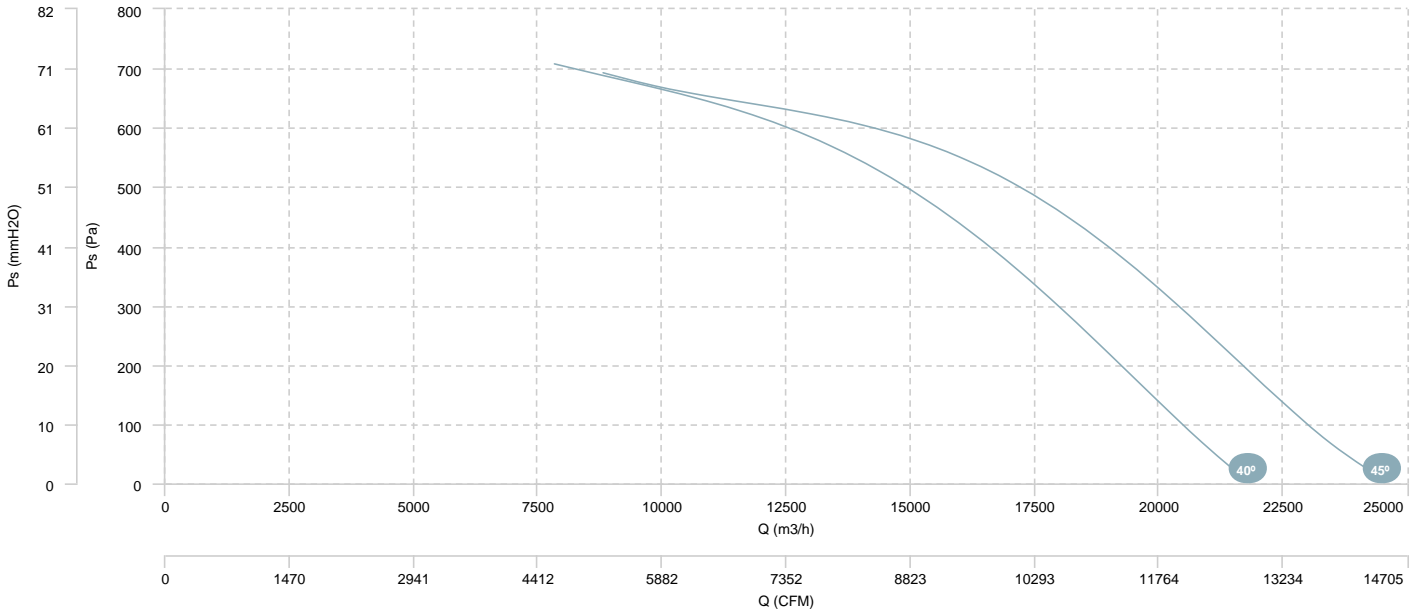

**AIR FLOW - ABSORBED POWER (2 poles)**

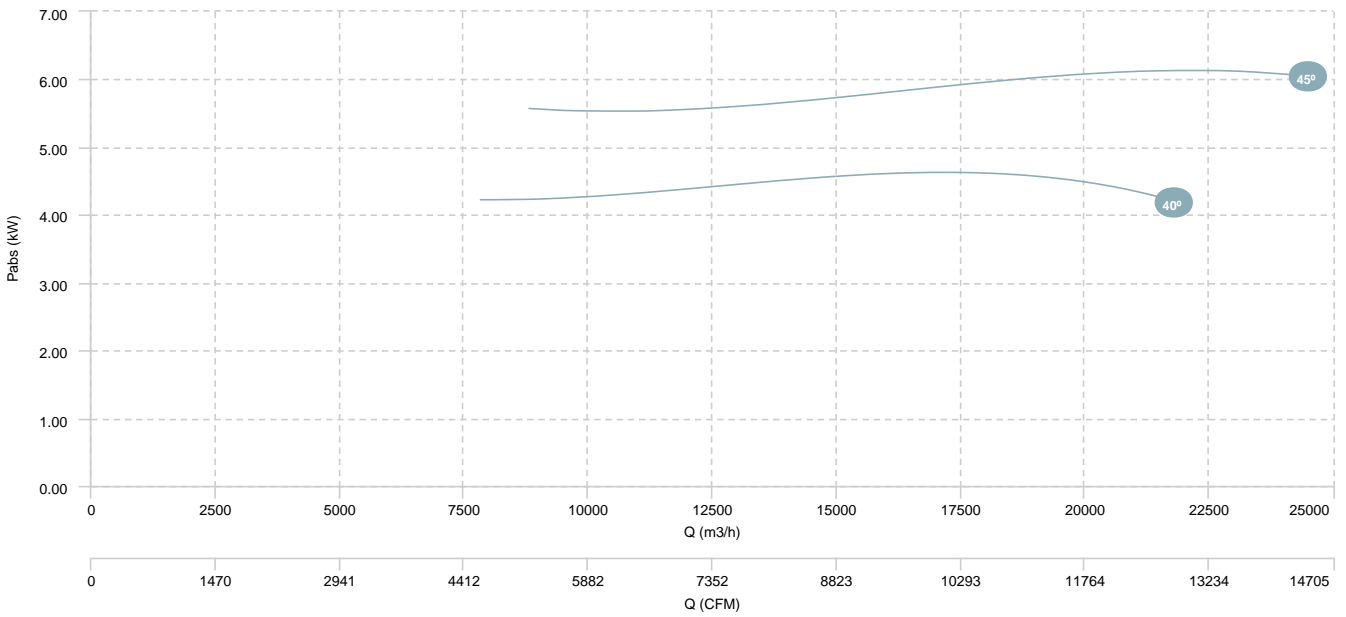



HM 56 T2/T4 5,5/1,5kW (A9:5)

AIR FLOW - PRESSURE (4 poles)

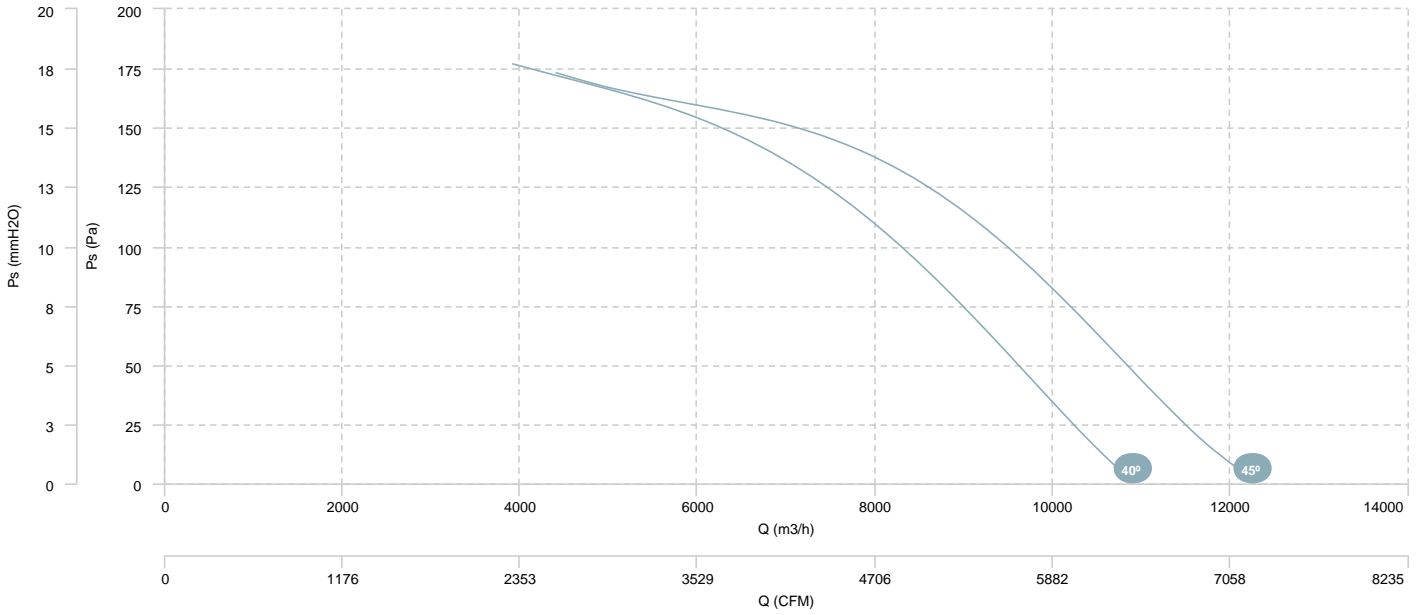

HM 56 T2/T4 1,5/0,37kW (A9:4)	HM 56 T2/T4 2,2/0,55kW (A9:4)	HM 56 T2/T4 3/0,75kW (A9:4)
HM 56 T2/T4 4,5/0,9kW (A9:4)		

## AIR FLOW - PRESSURE (2 poles)

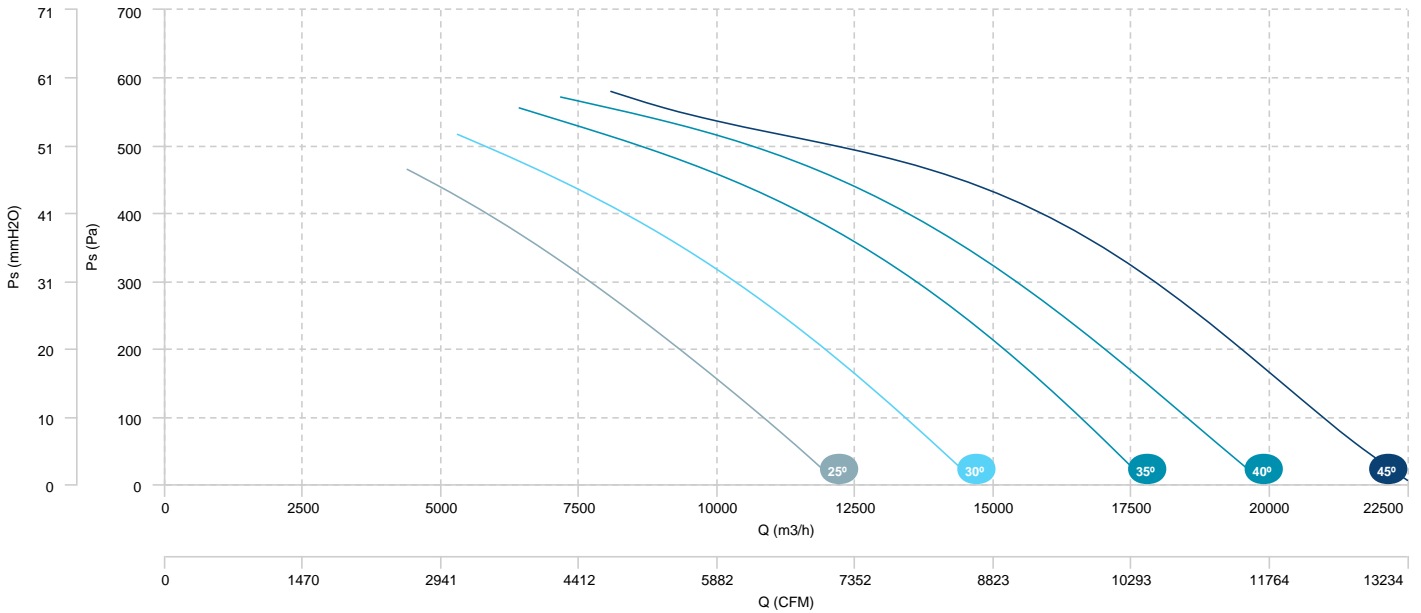

## AIR FLOW - ABSORBED POWER (2 poles)

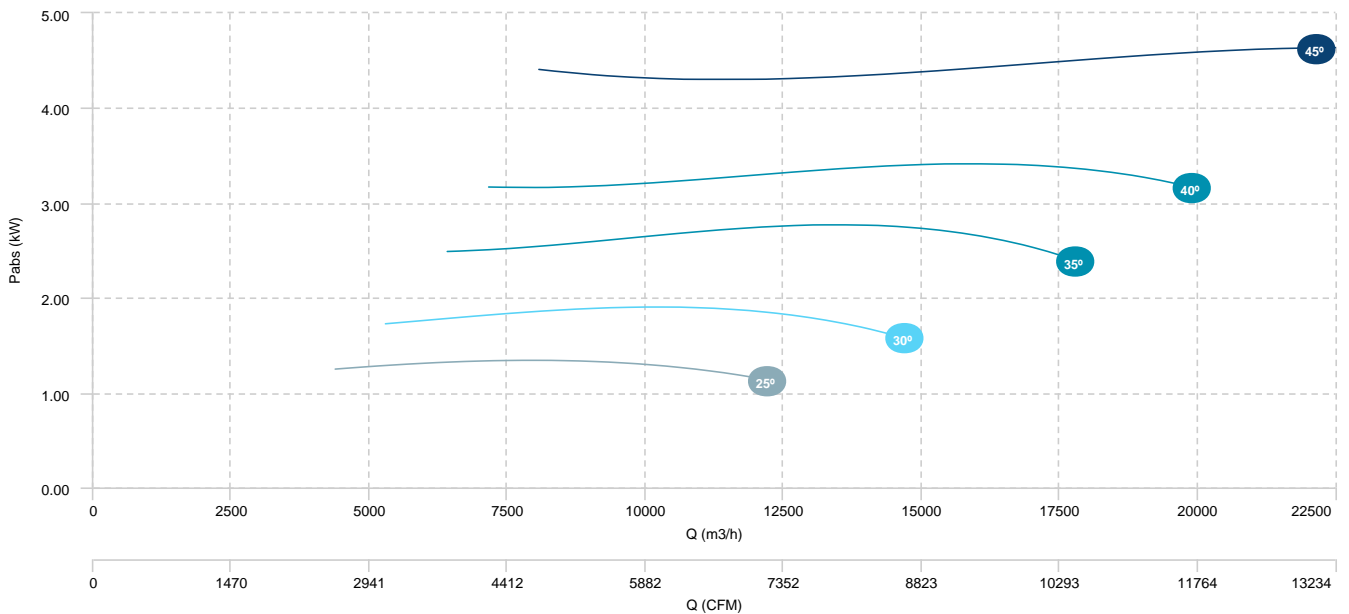

HM 56 T2/T4 1,5/0,37kW (A9:4)	HM 56 T2/T4 2,2/0,55kW (A9:4)	HM 56 T2/T4 3/0,75kW (A9:4)
HM 56 T2/T4 4,5/0,9kW (A9:4)		

## AIR FLOW - PRESSURE (4 poles)

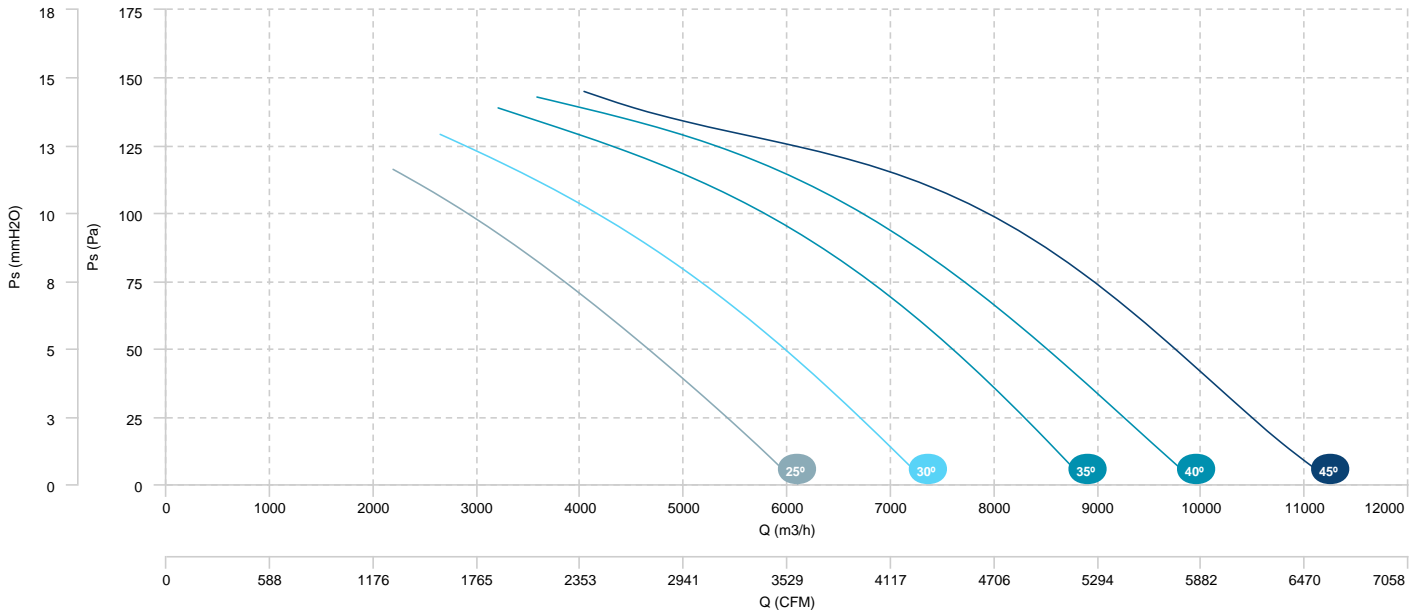

HM 56 T2/T4 2,2/0,55kW (A9:8)

HM 56 T2/T4 3/0,75kW (A9:8)

HM 56 T2/T4 4,5/0,9kW (A9:8)

AIR FLOW - PRESSURE (2 poles)

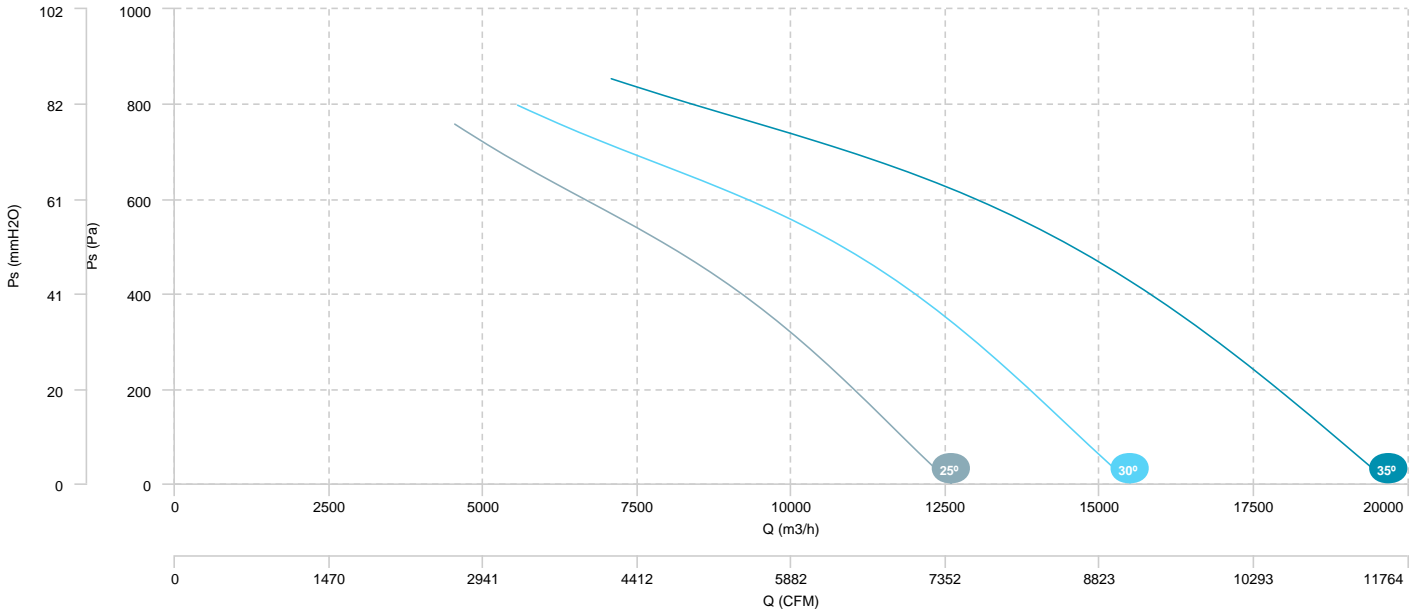

AIR FLOW - ABSORBED POWER (2 poles)

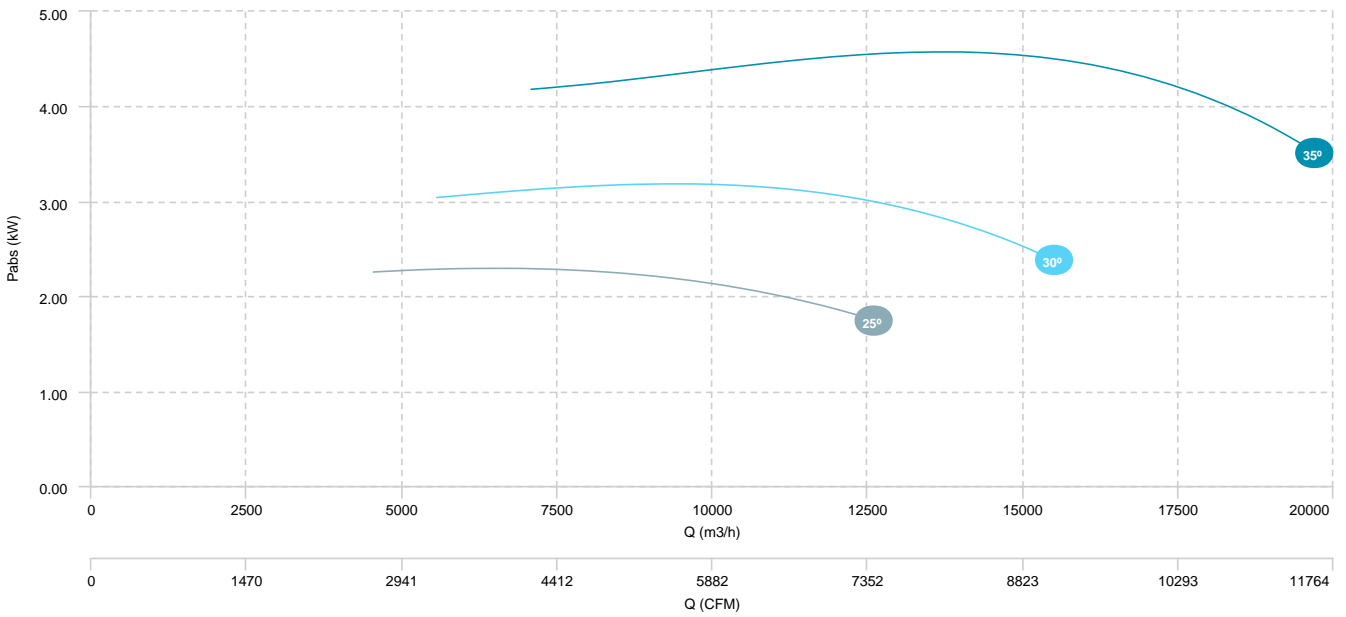

HM 56 T2/T4 2,2/0,55kW (A9:8)

HM 56 T2/T4 3/0,75kW (A9:8)

HM 56 T2/T4 4,5/0,9kW (A9:8)

AIR FLOW - PRESSURE (4 poles)

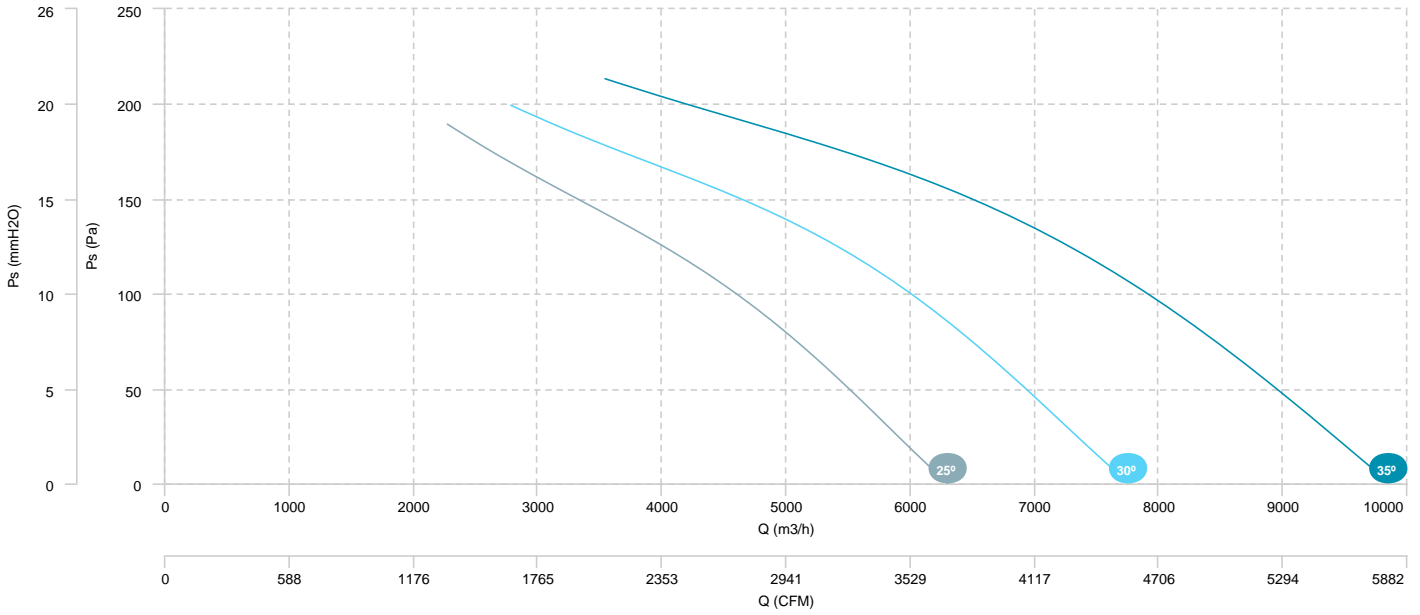

HM 56 T4/T6 0,55/0,18kW (A2:9)	HM 56 T4/T6 0,75/0,25kW (A2:9)	HM 56 T4/T6 1,1/0,37kW (A2:9)
HM 56 T4/T6 1,5/0,5kW (A2:9)		

## AIR FLOW - PRESSURE (4 poles)

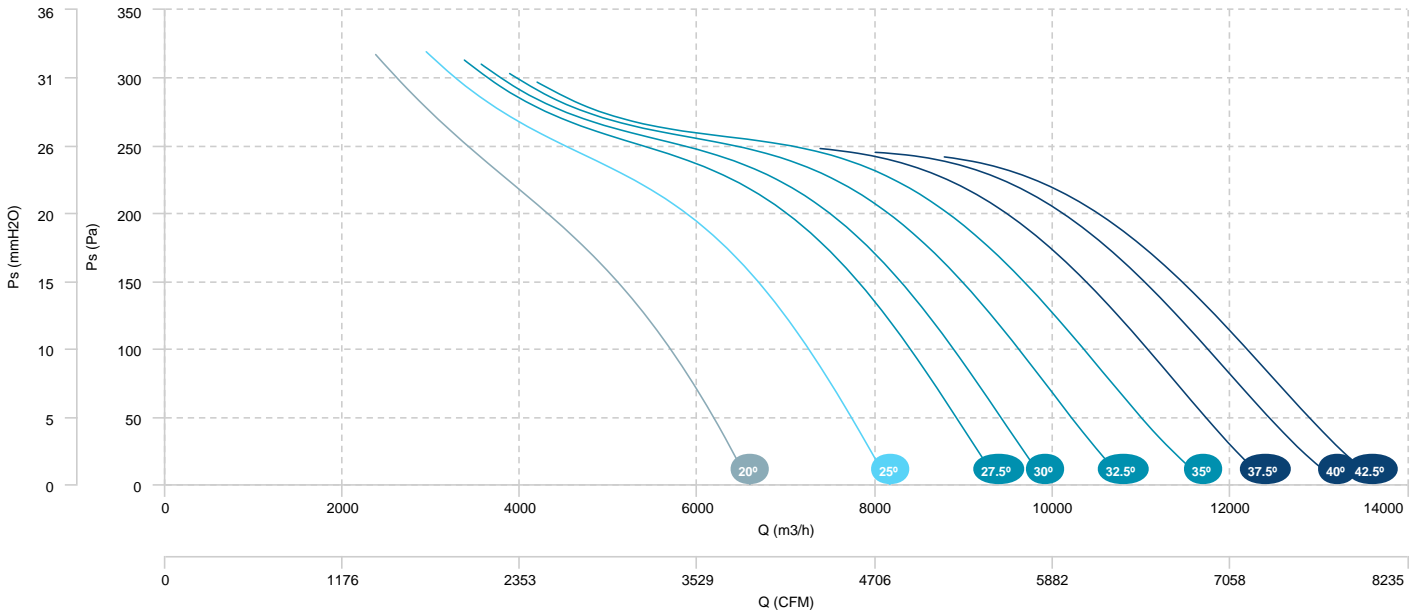

## AIR FLOW - ABSORBED POWER (4 poles)

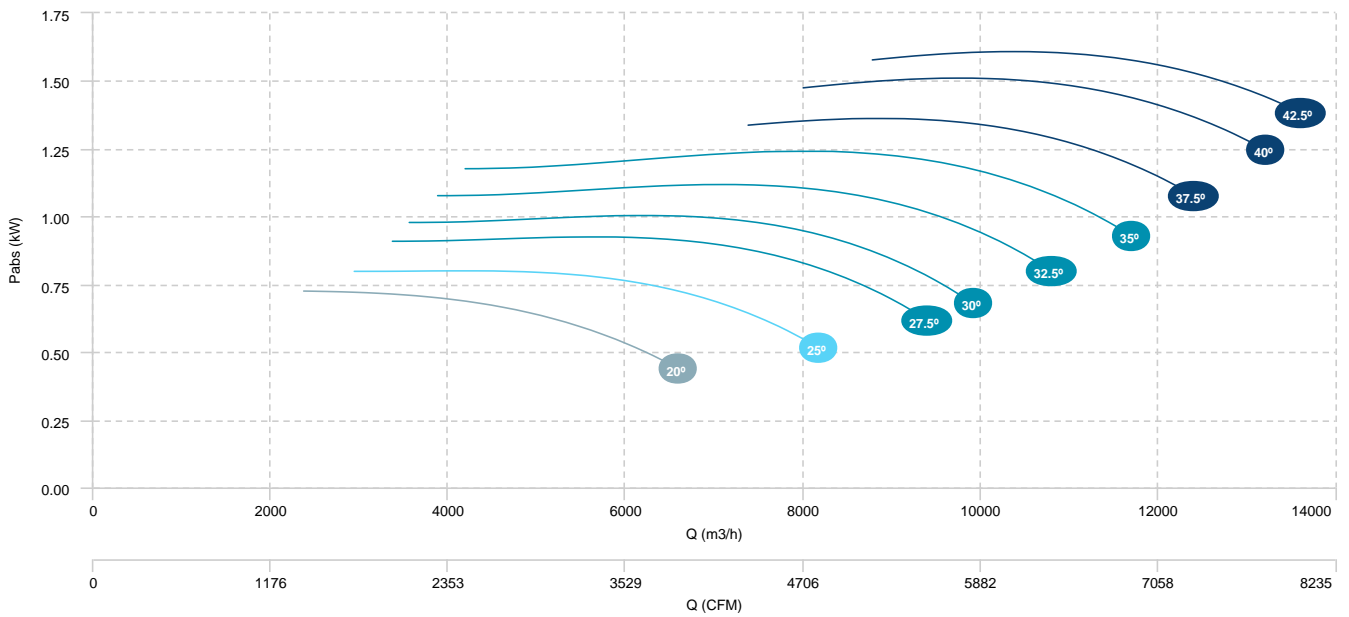

HM 56 T4/T6 0,55/0,18kW (A2:9)	HM 56 T4/T6 0,75/0,25kW (A2:9)	HM 56 T4/T6 1,1/0,37kW (A2:9)
HM 56 T4/T6 1,5/0,5kW (A2:9)		

## AIR FLOW - PRESSURE (6 poles)

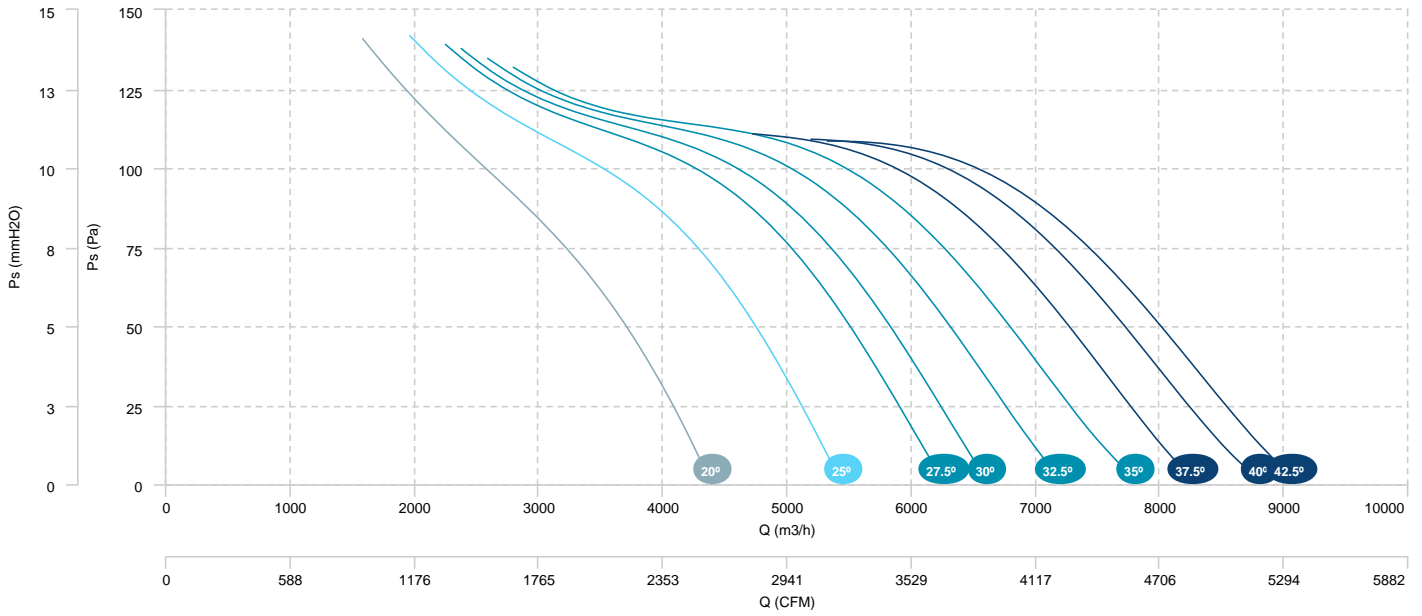

HM 56 T4/T6 0,55/0,18kW (A2:6)	HM 56 T4/T6 0,75/0,25kW (A2:6)	HM 56 T4/T6 1,1/0,37kW (A2:6)
HM 56 T4/T6 1,5/0,5kW (A2:6)		

## AIR FLOW - PRESSURE (4 poles)

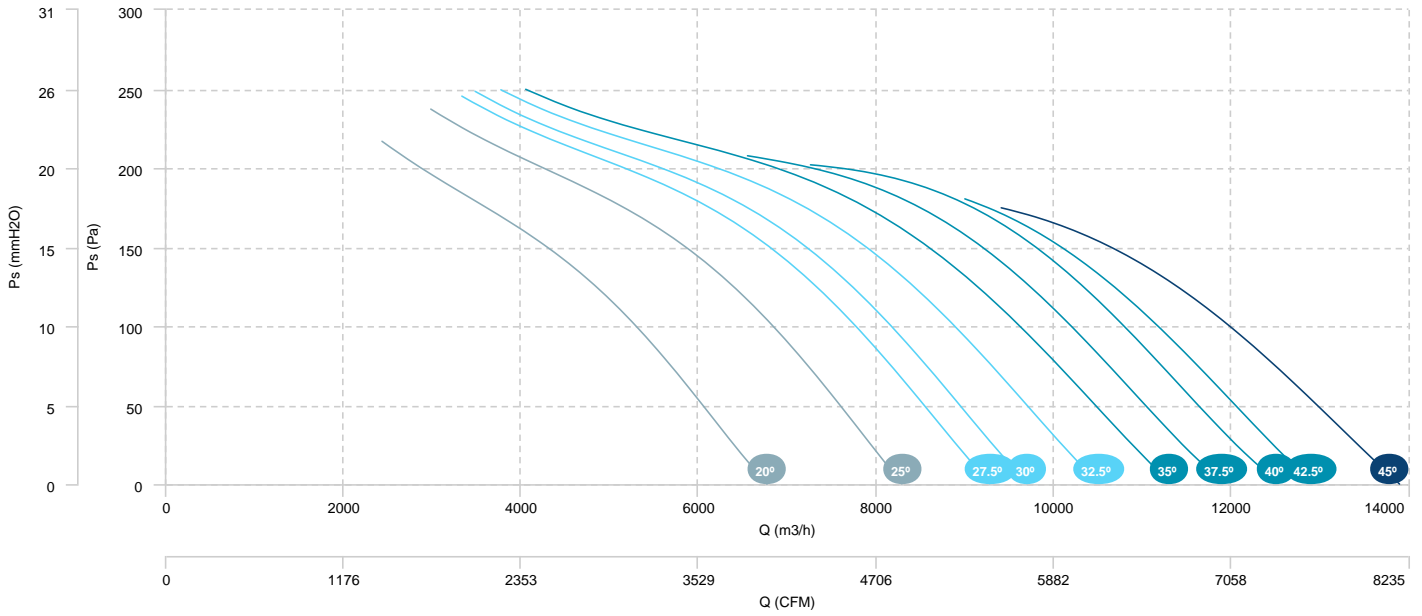

## AIR FLOW - ABSORBED POWER (4 poles)

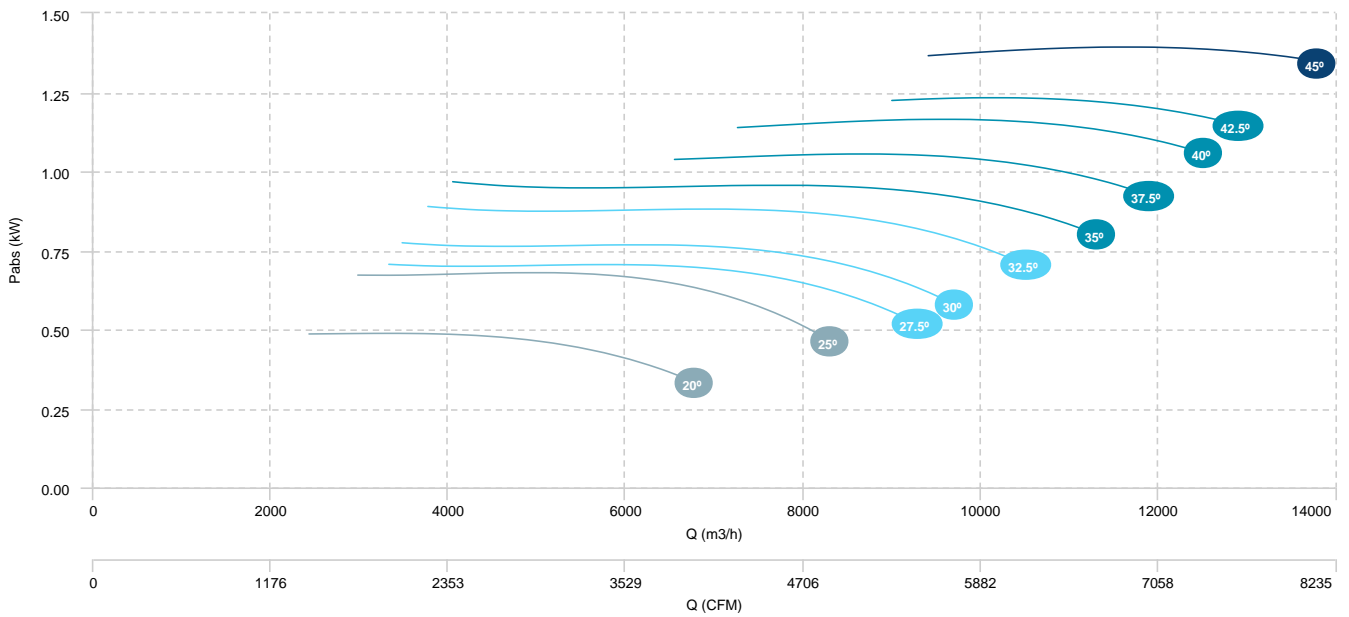



- HM 56 T4/T6 0,55/0,18kW (A2:6)
- HM 56 T4/T6 0,75/0,25kW (A2:6)
- HM 56 T4/T6 1,1/0,37kW (A2:6)
- HM 56 T4/T6 1,5/0,5kW (A2:6)

## AIR FLOW - PRESSURE (6 poles)

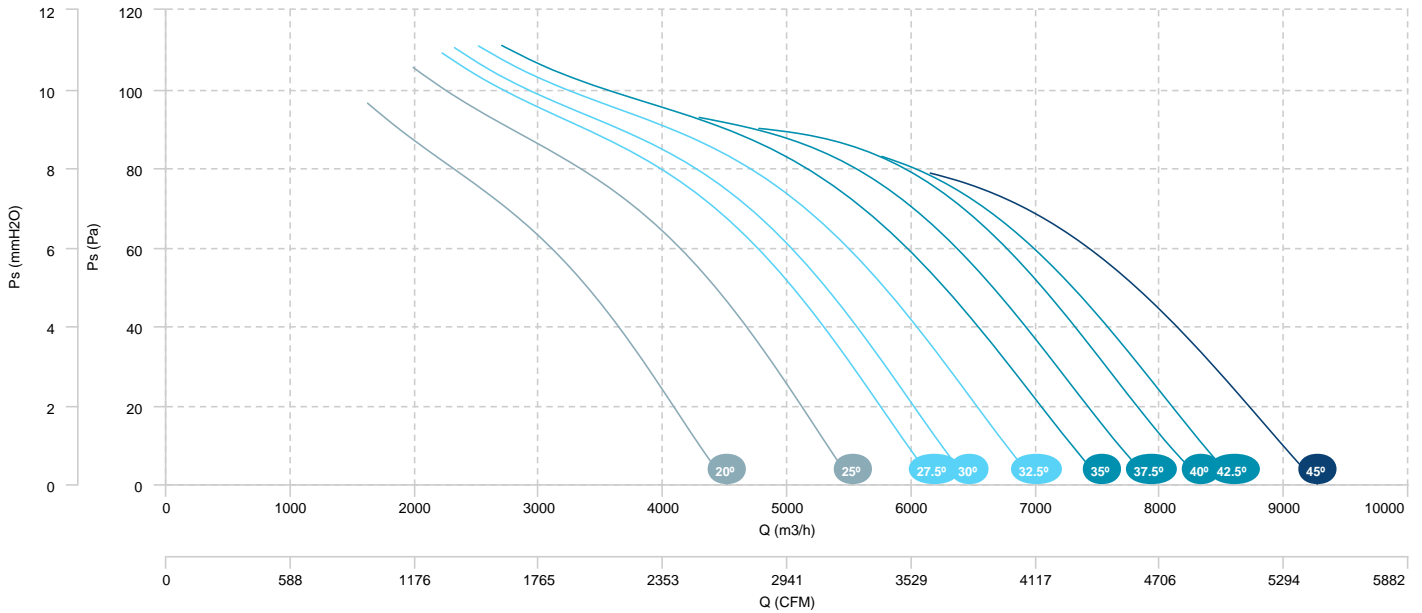

HM 56 T4/T6 0,37/0,13kW (A5:6)	HM 56 T4/T6 0,55/0,18kW (A5:6)	HM 56 T4/T6 0,75/0,25kW (A5:6)
HM 56 T4/T6 1,1/0,37kW (A5:6)	HM 56 T4/T6 1,5/0,5kW (A5:6)	

## AIR FLOW - PRESSURE (4 poles)

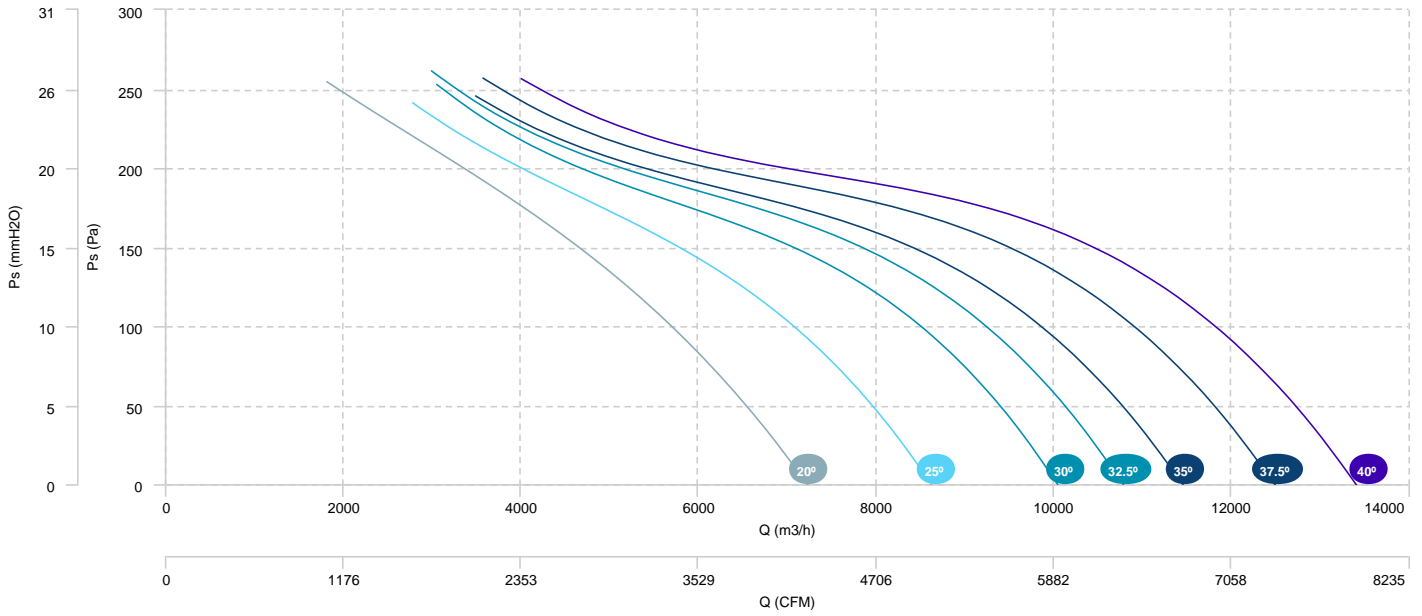

## AIR FLOW - ABSORBED POWER (4 poles)

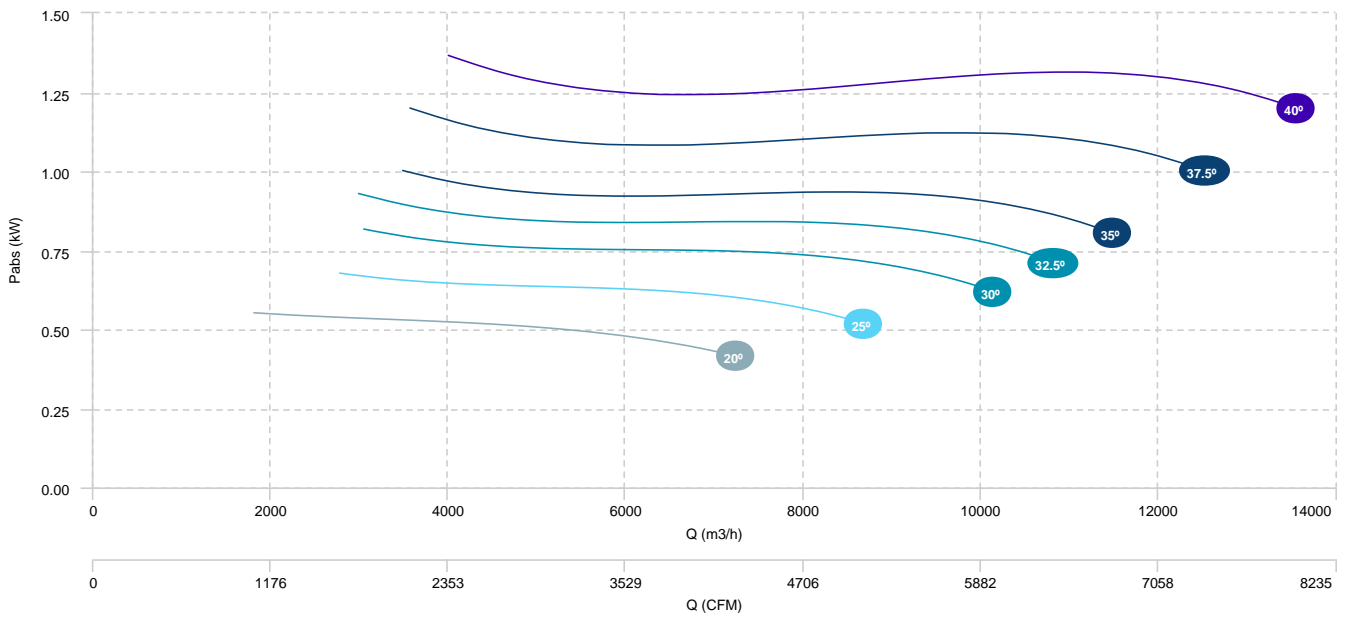

HM 56 T4/T6 0,37/0,13kW (A5:6)	HM 56 T4/T6 0,55/0,18kW (A5:6)	HM 56 T4/T6 0,75/0,25kW (A5:6)
HM 56 T4/T6 1,1/0,37kW (A5:6)	HM 56 T4/T6 1,5/0,5kW (A5:6)	

## AIR FLOW - PRESSURE (6 poles)

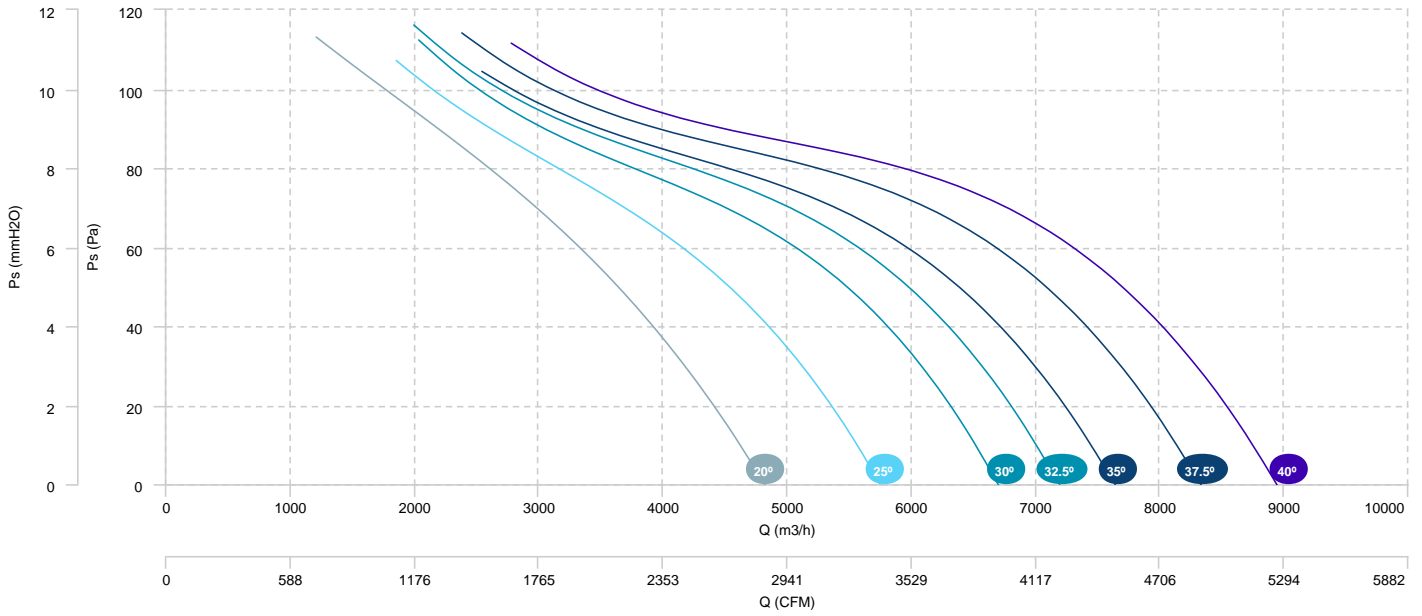

HM 56 T4/T8 0,55/0,09kW (A2:6)	HM 56 T4/T8 0,75/0,12kW (A2:6)	HM 56 T4/T8 1,1/0,18kW (A2:6)
HM 56 T4/T8 1,5/0,25kW (A2:6)		

## AIR FLOW - PRESSURE (4 poles)

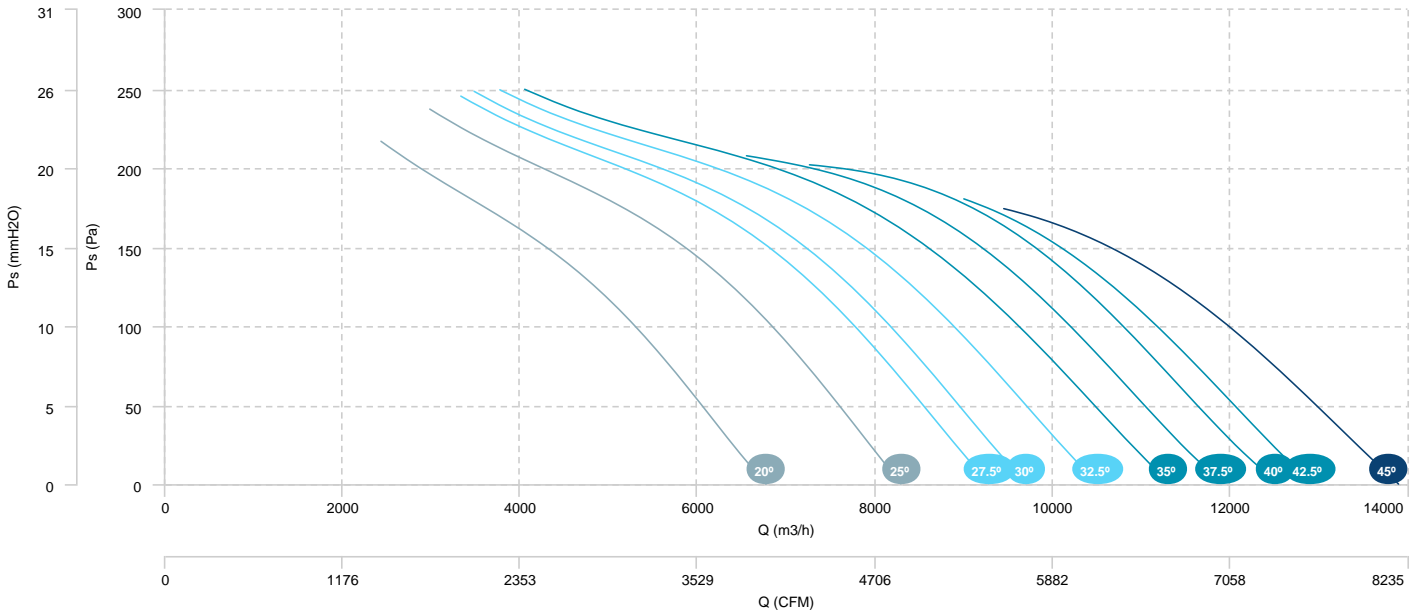

## AIR FLOW - ABSORBED POWER (4 poles)

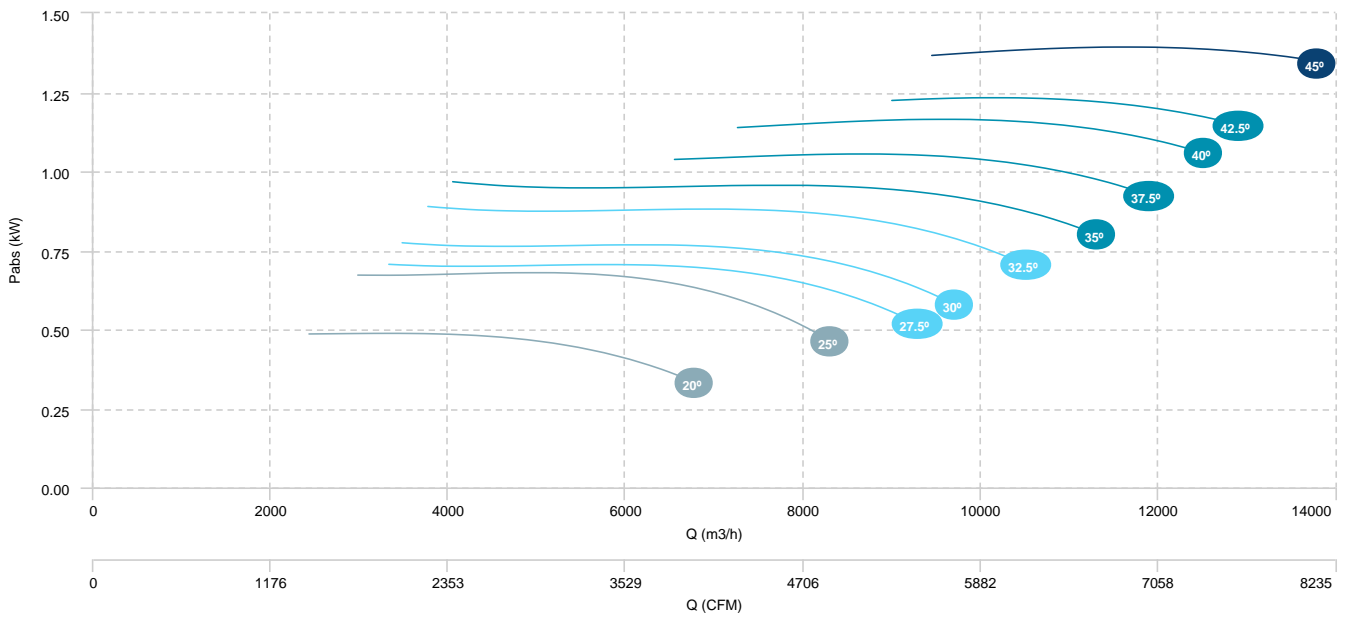

HM 56 T4/T8 0,55/0,09kW (A2:6)	HM 56 T4/T8 0,75/0,12kW (A2:6)	HM 56 T4/T8 1,1/0,18kW (A2:6)
HM 56 T4/T8 1,5/0,25kW (A2:6)		

AIR FLOW - PRESSURE (8 poles)

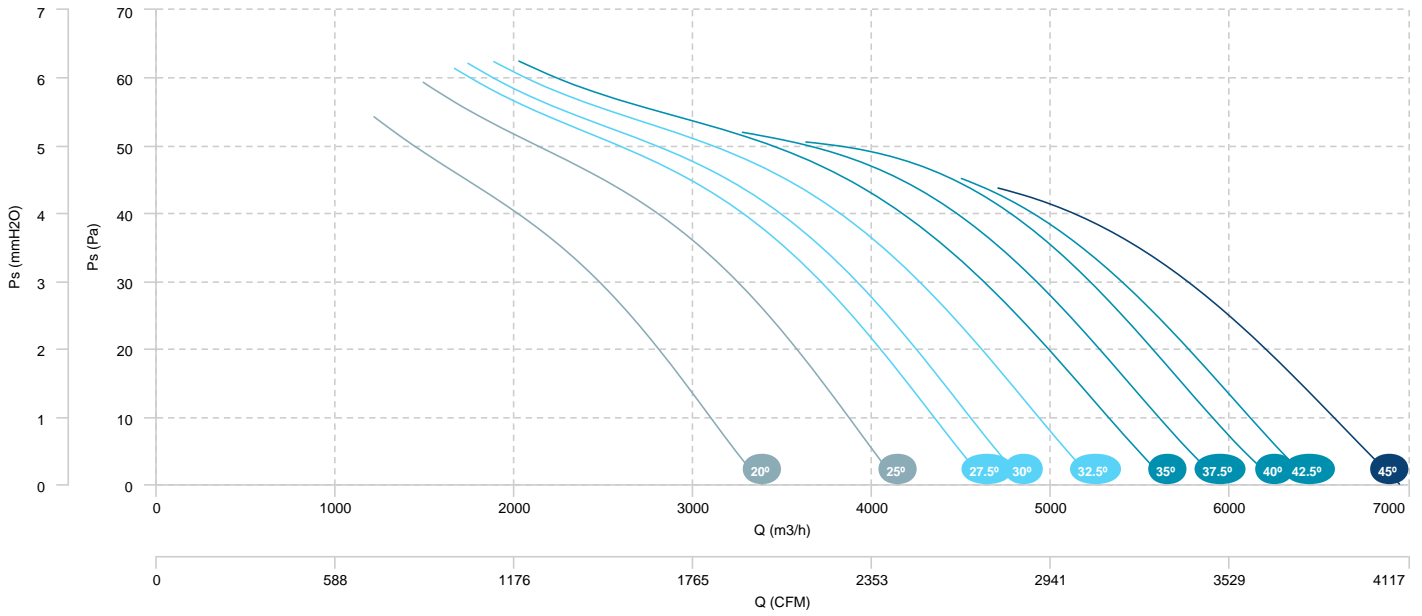

HM 56 T4/T8 0,55/0,09kW (A2:9)	HM 56 T4/T8 0,75/0,12kW (A2:9)	HM 56 T4/T8 1,1/0,18kW (A2:9)
HM 56 T4/T8 1,5/0,25kW (A2:9)		

## AIR FLOW - PRESSURE (4 poles)

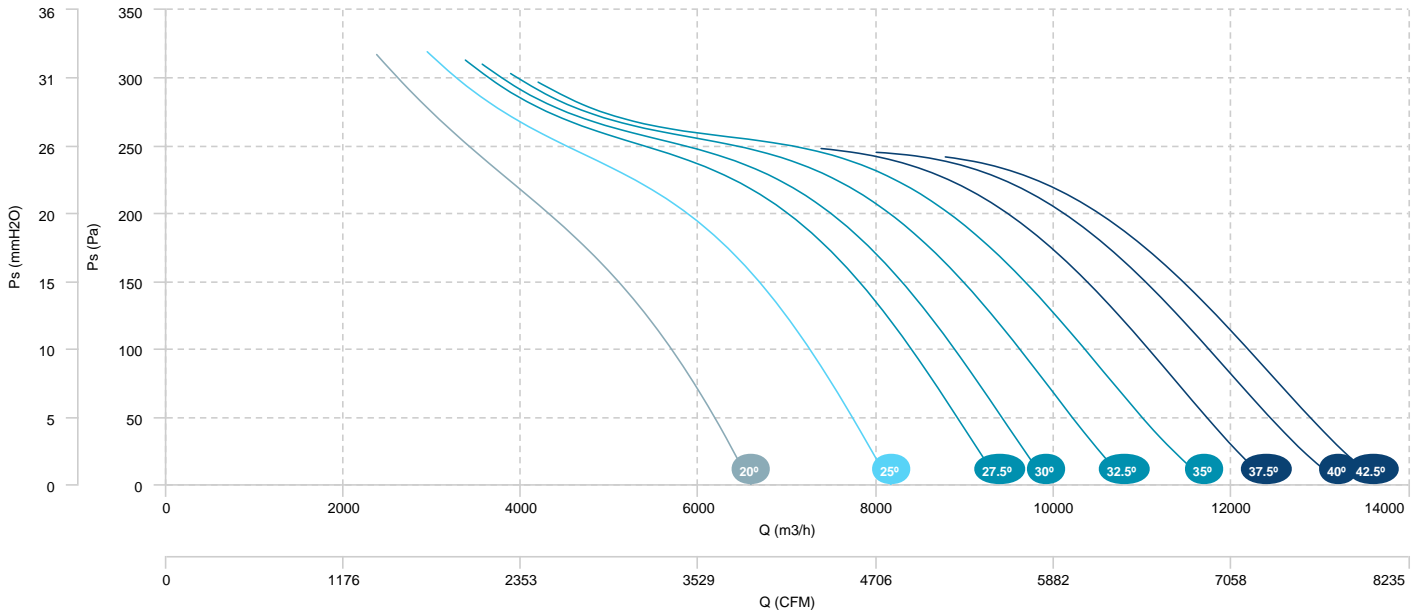

## AIR FLOW - ABSORBED POWER (4 poles)

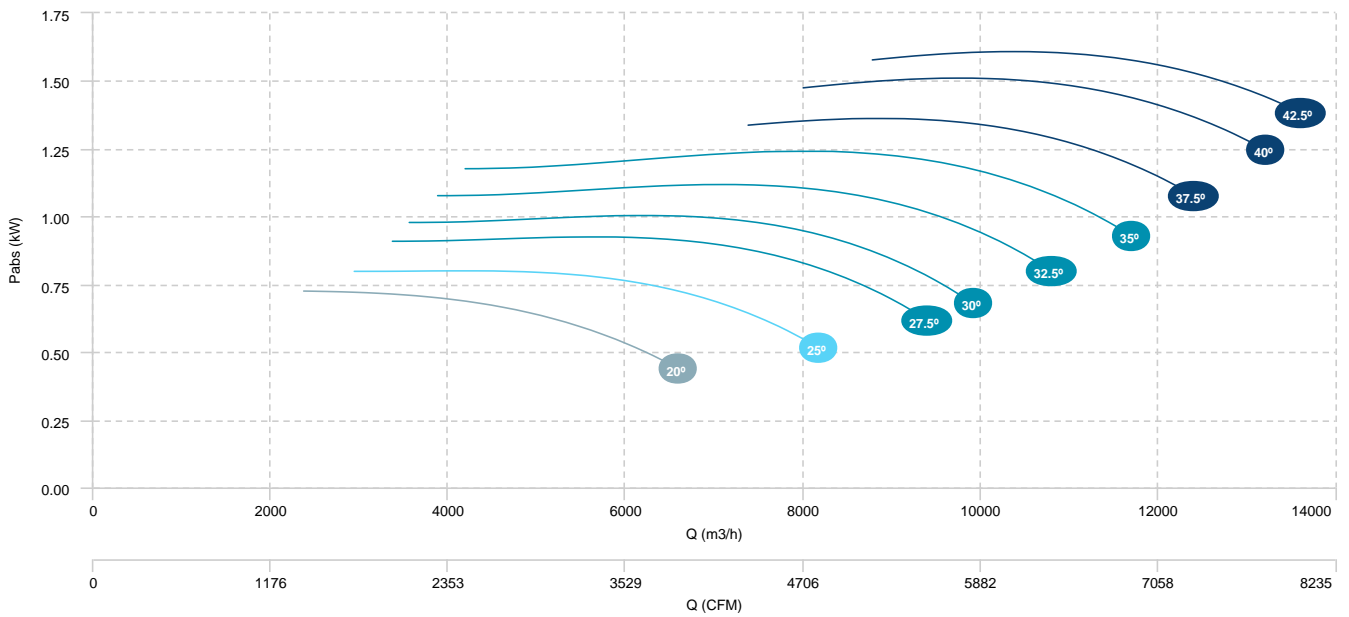

HM 56 T4/T8 0,55/0,09kW (A2:9)  
 HM 56 T4/T8 1,5/0,25kW (A2:9)

HM 56 T4/T8 0,75/0,12kW (A2:9)

HM 56 T4/T8 1,1/0,18kW (A2:9)

AIR FLOW - PRESSURE (8 poles)

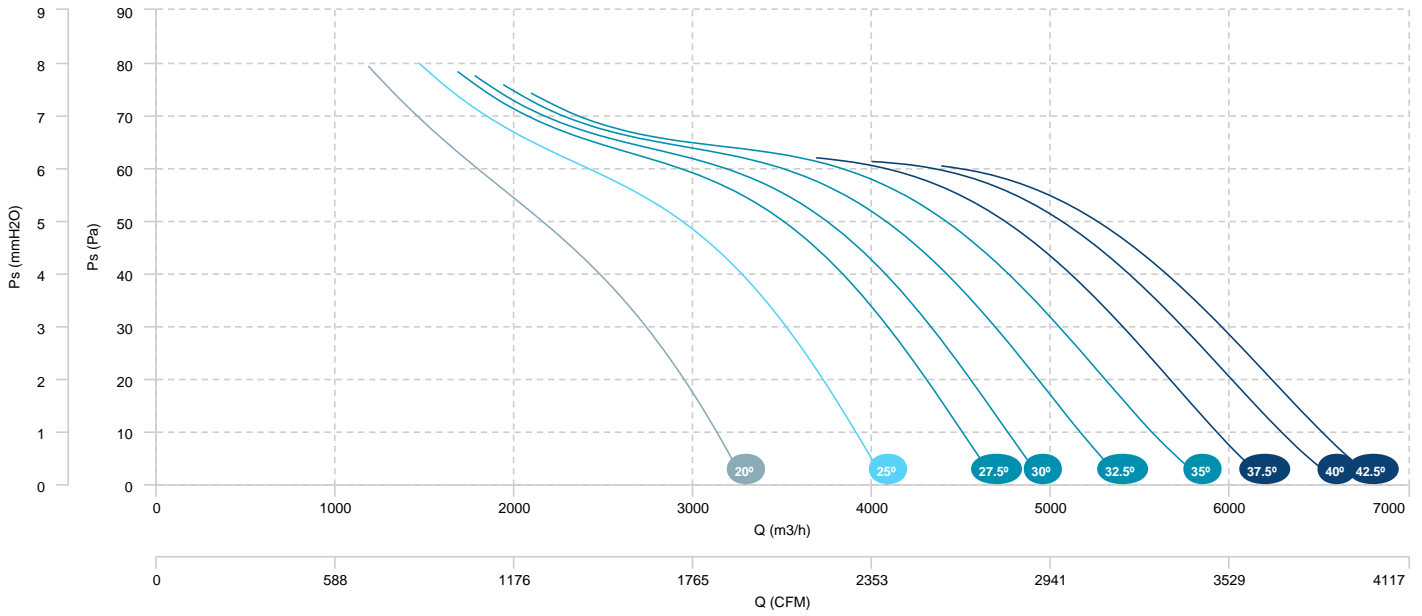

HM 56 T4/T8 0,33/0,04kW (A5:6)	HM 56 T4/T8 0,55/0,09kW (A5:6)	HM 56 T4/T8 0,75/0,12kW (A5:6)
HM 56 T4/T8 1,1/0,18kW (A5:6)	HM 56 T4/T8 1,5/0,25kW (A5:6)	

## AIR FLOW - PRESSURE (4 poles)

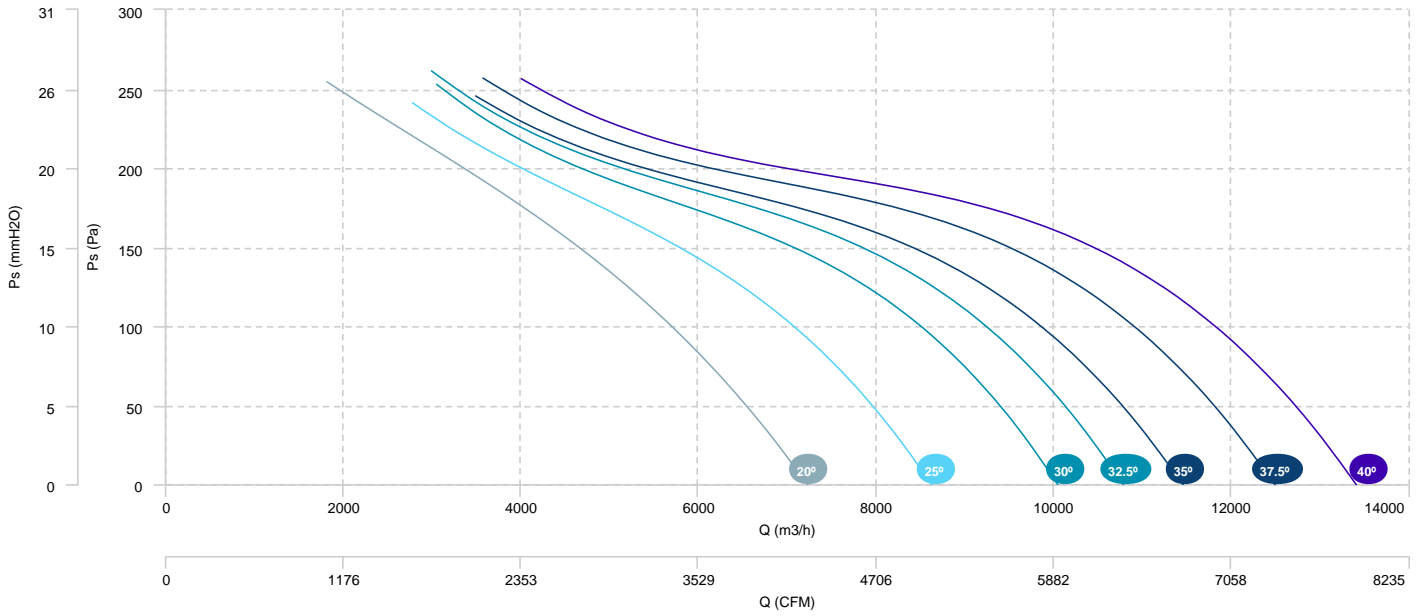

## AIR FLOW - ABSORBED POWER (4 poles)

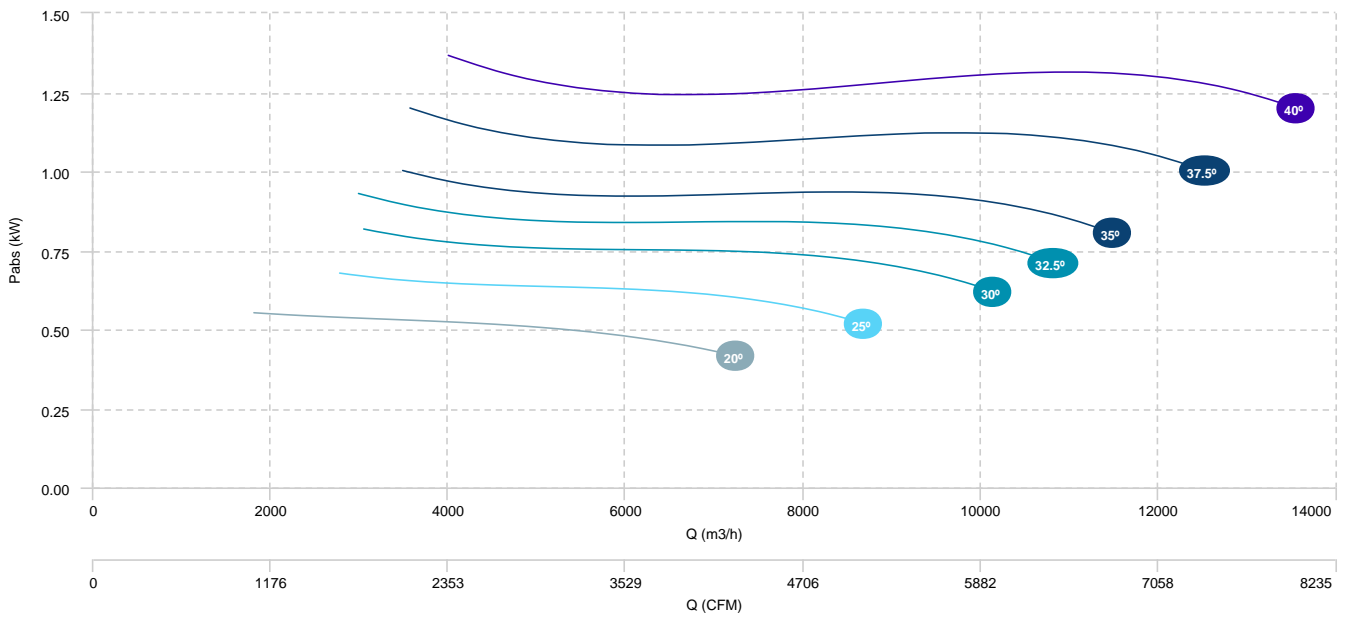



HM 56 T4/T8 0,33/0,04kW (A5:6)	HM 56 T4/T8 0,55/0,09kW (A5:6)	HM 56 T4/T8 0,75/0,12kW (A5:6)
HM 56 T4/T8 1,1/0,18kW (A5:6)	HM 56 T4/T8 1,5/0,25kW (A5:6)	

## AIR FLOW - PRESSURE (8 poles)

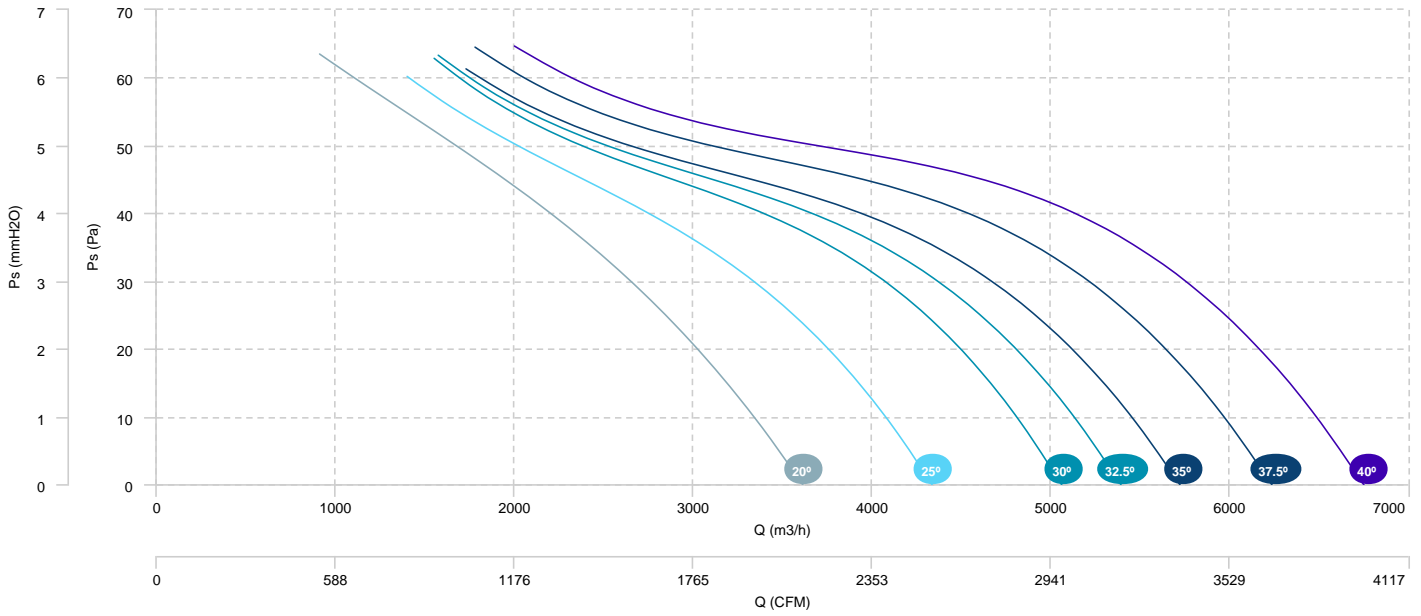

HM 63 T2 5,5kW (A9:10)	HM 63 T2 7,5kW (A9:10)	HM 63 T2 11kW (A9:10)
HM 63 T2 15kW (A9:10)		

## AIR FLOW - PRESSURE

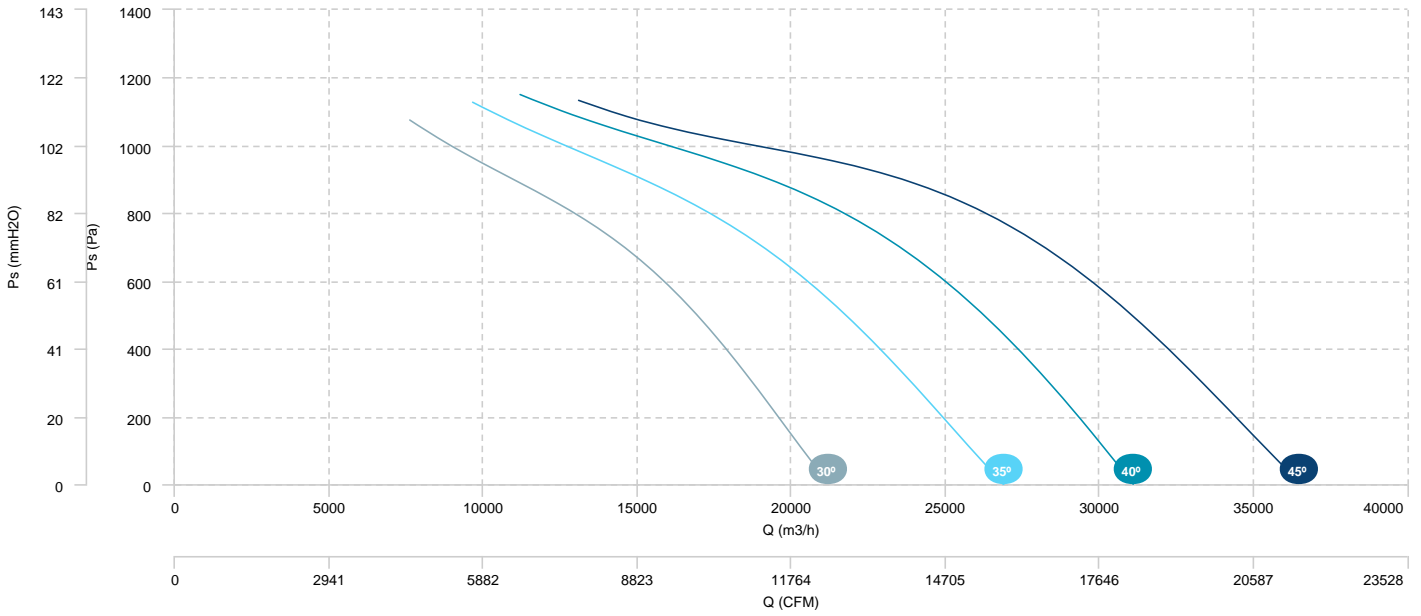

## AIR FLOW - ABSORBED POWER

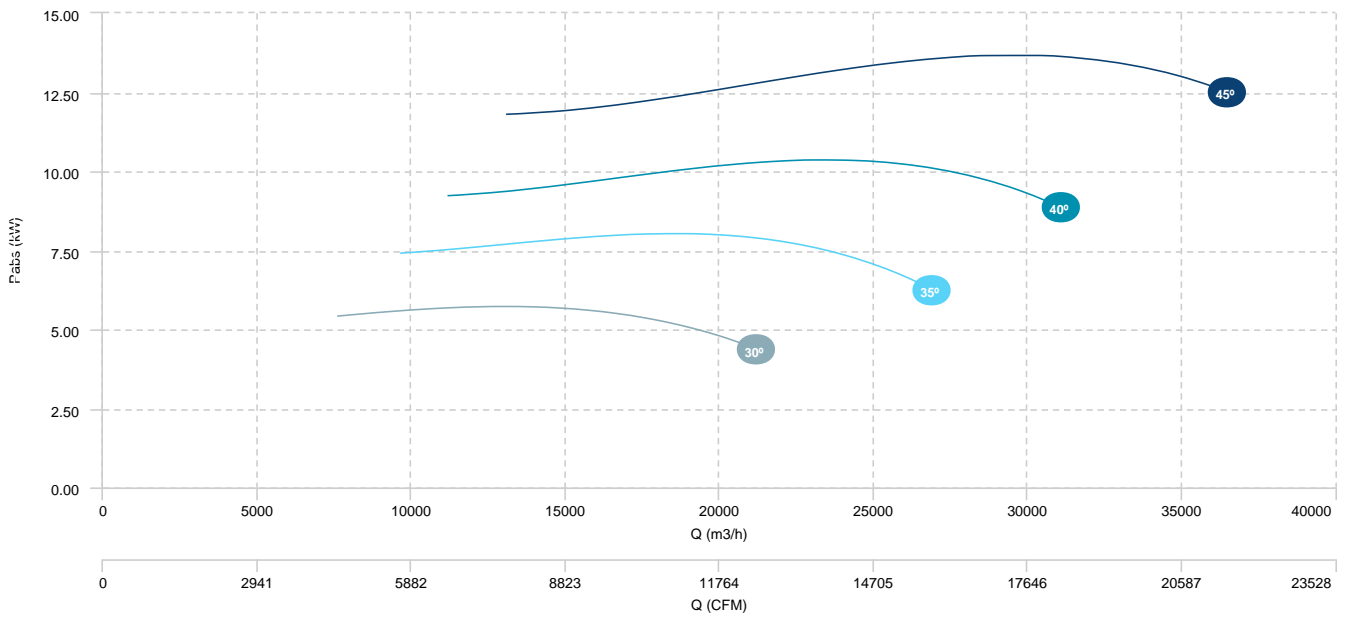

HM 63 T2 7,5kW (A9:5)

HM 63 T2 11kW (A9:5)

AIR FLOW - PRESSURE

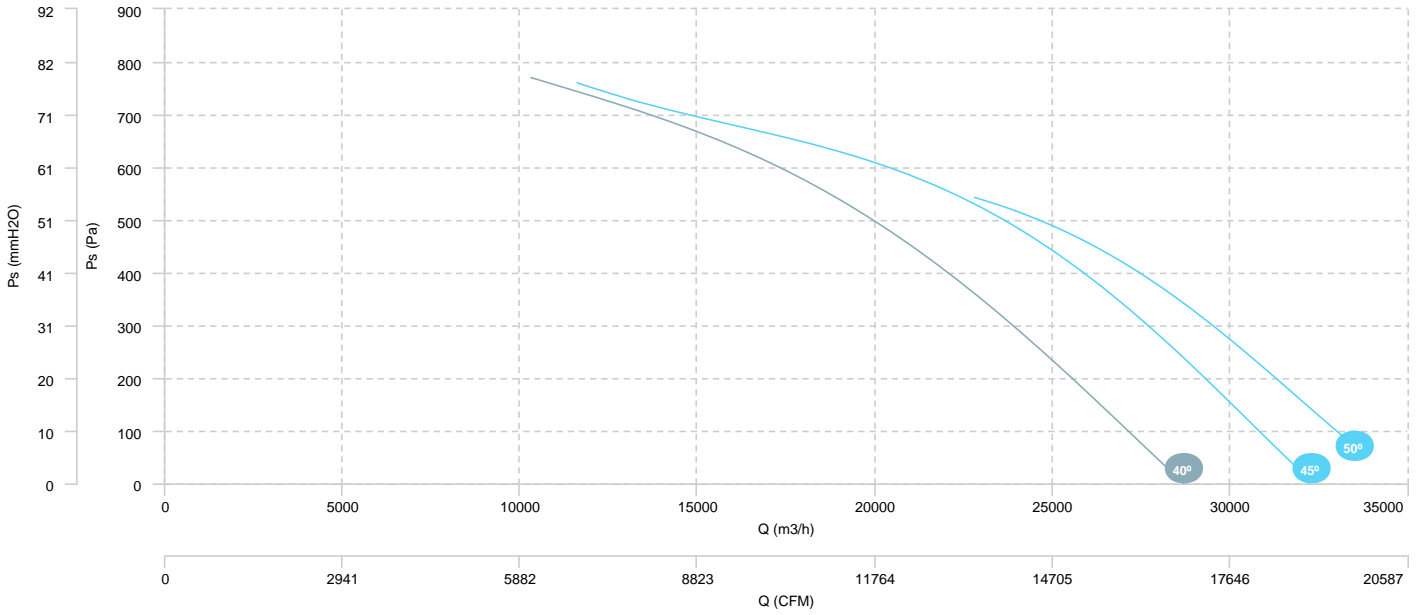

AIR FLOW - ABSORBED POWER

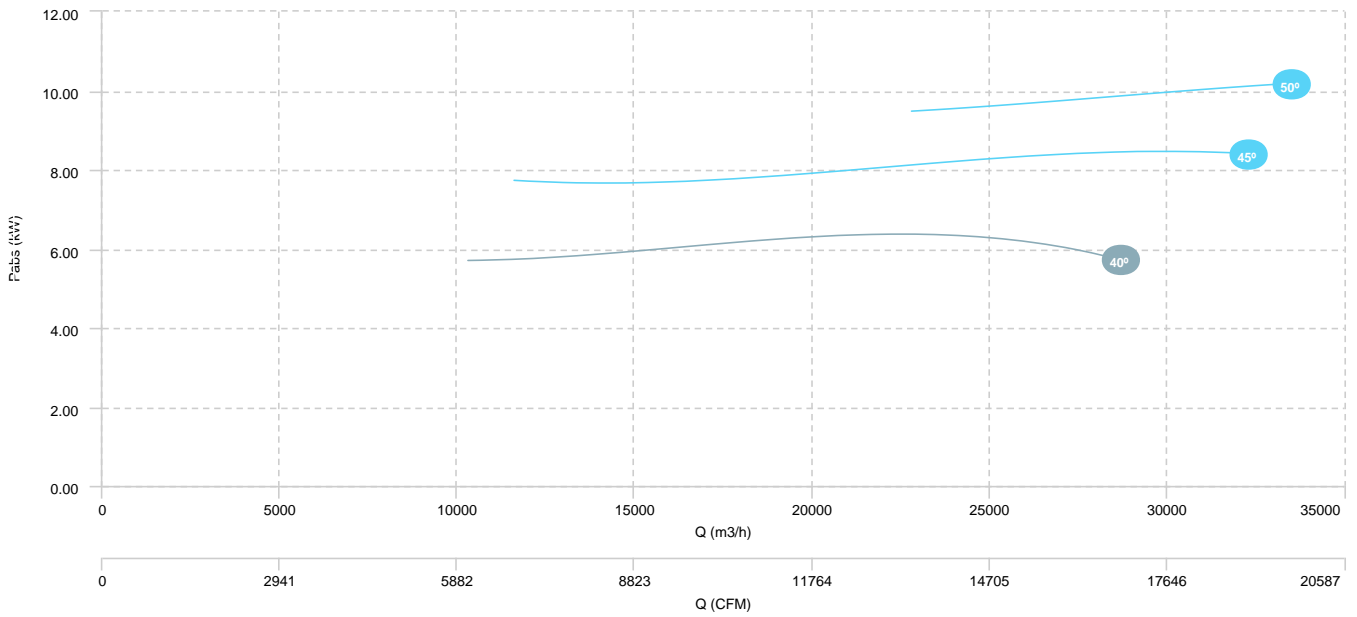

HM 63 T2 3kW (A9:8)

HM 63 T2 4kW (A9:8)

AIR FLOW - PRESSURE

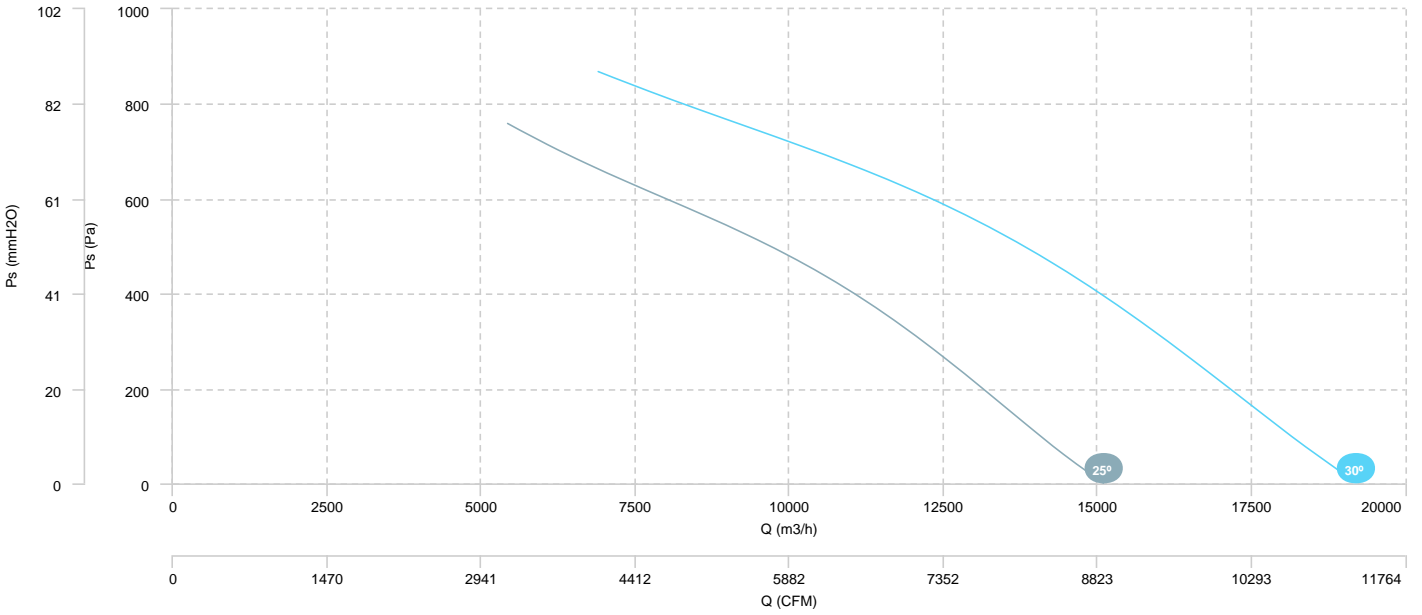

AIR FLOW - ABSORBED POWER

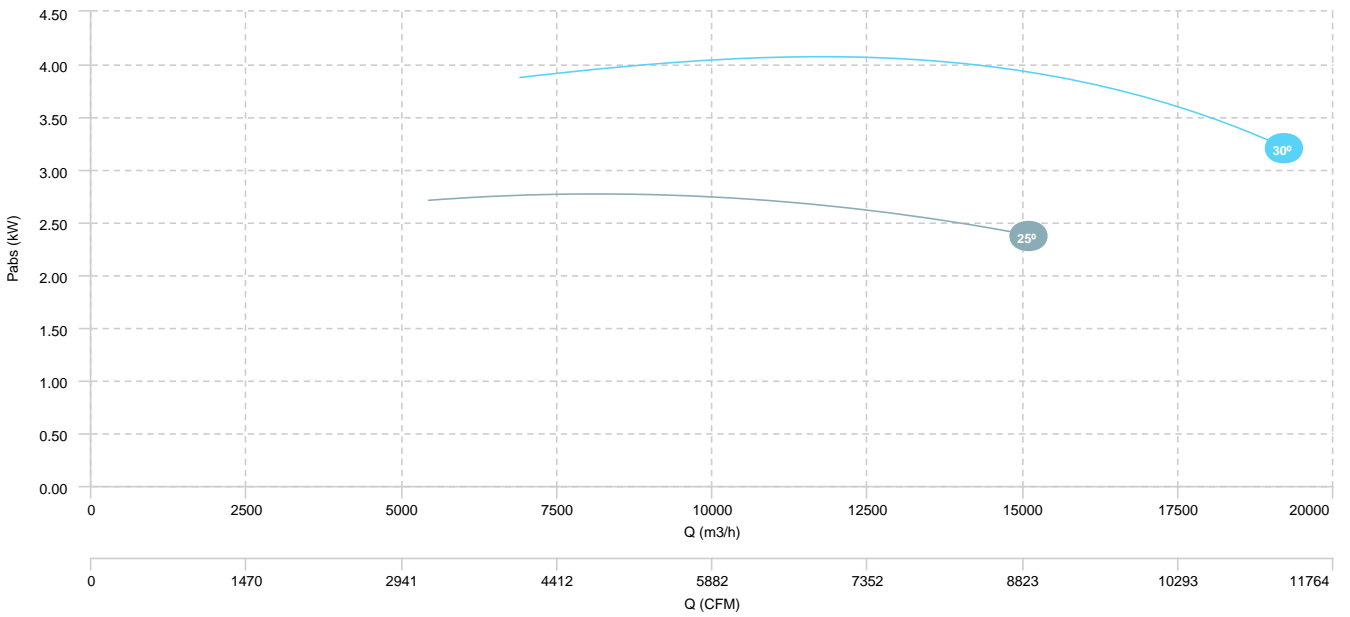

- HM 63 T2 1,5kW (A9:4)
- HM 63 T2 2,2kW (A9:4)
- HM 63 T2 3kW (A9:4)
- HM 63 T2 4kW (A9:4)

## AIR FLOW - PRESSURE

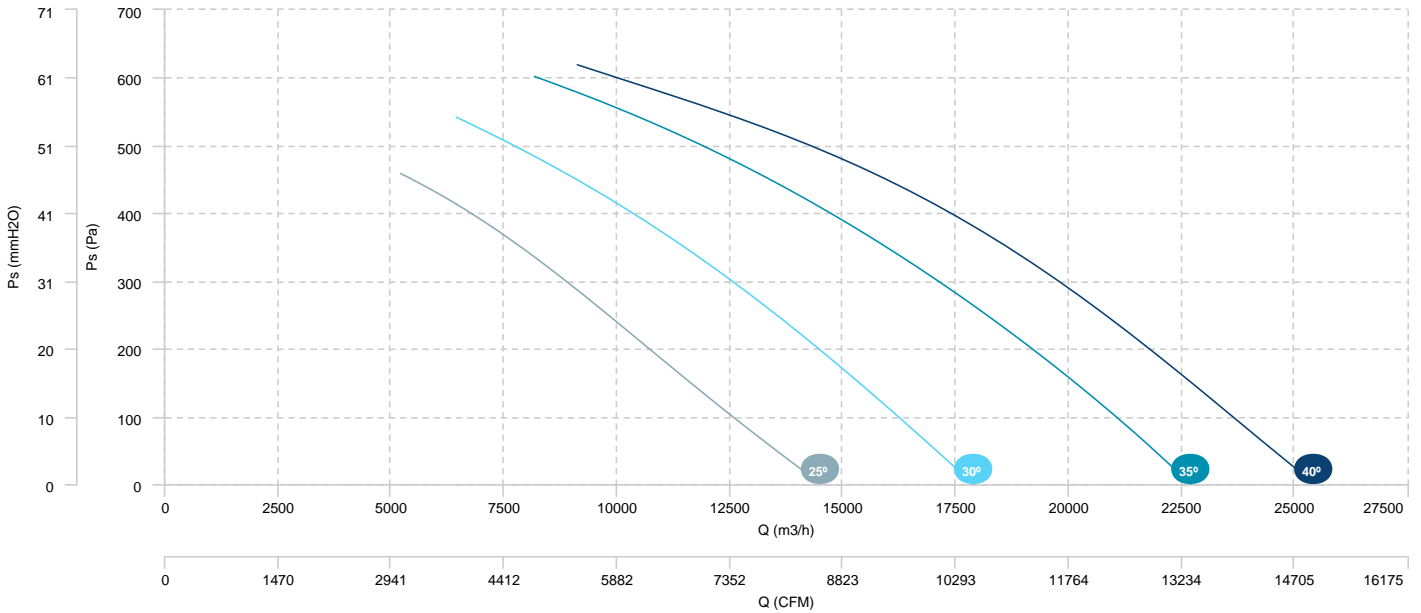

## AIR FLOW - ABSORBED POWER

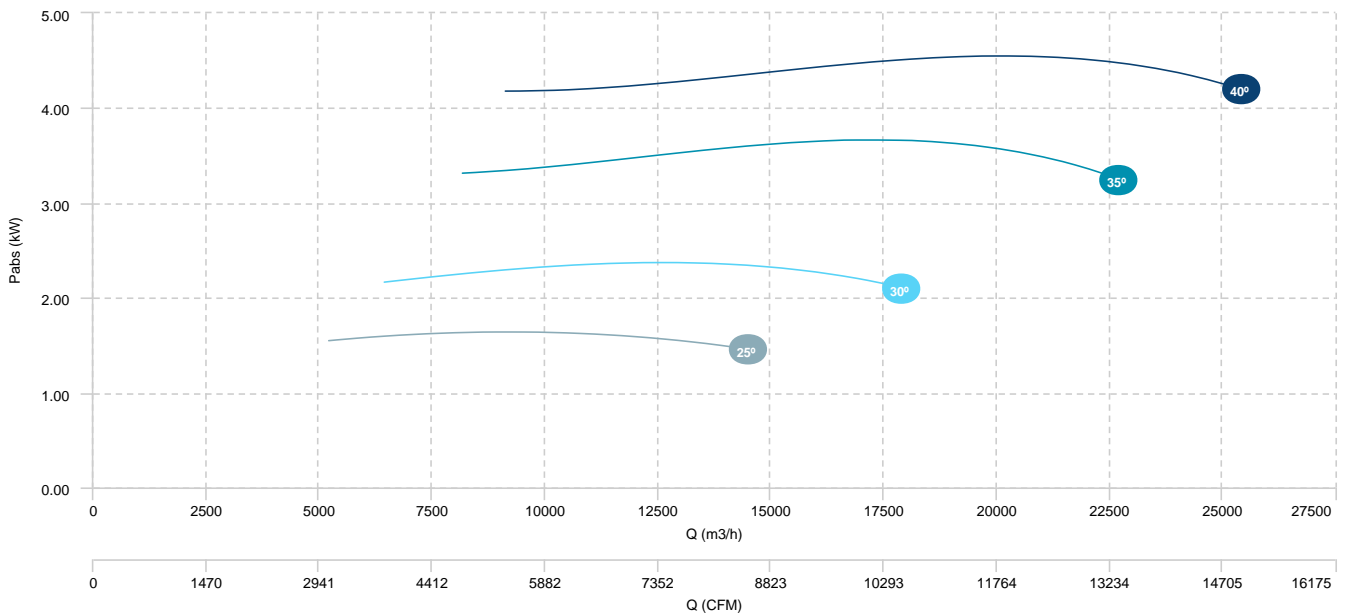

- HM 63 T4 0,75kW (A5:6)
- HM 63 T4 1,1kW (A5:6)
- HM 63 T4 1,5kW (A5:6)
- HM 63 T4 2,2kW (A5:6)

**AIR FLOW - PRESSURE**

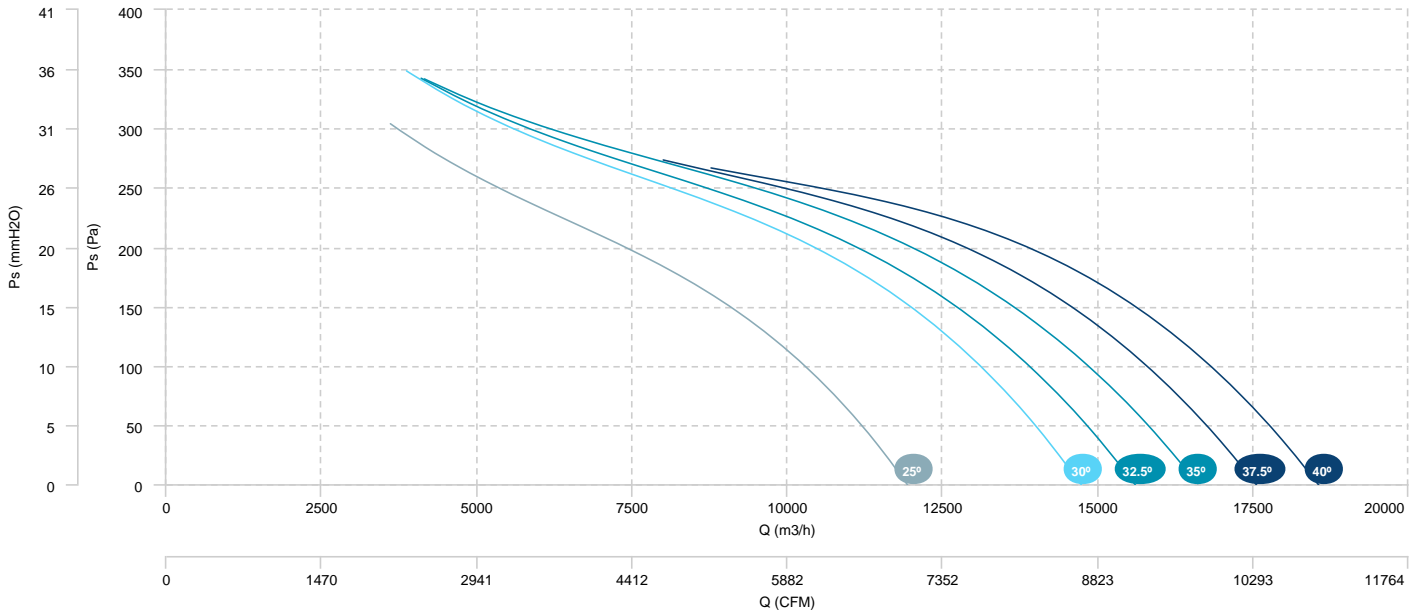

**AIR FLOW - ABSORBED POWER**

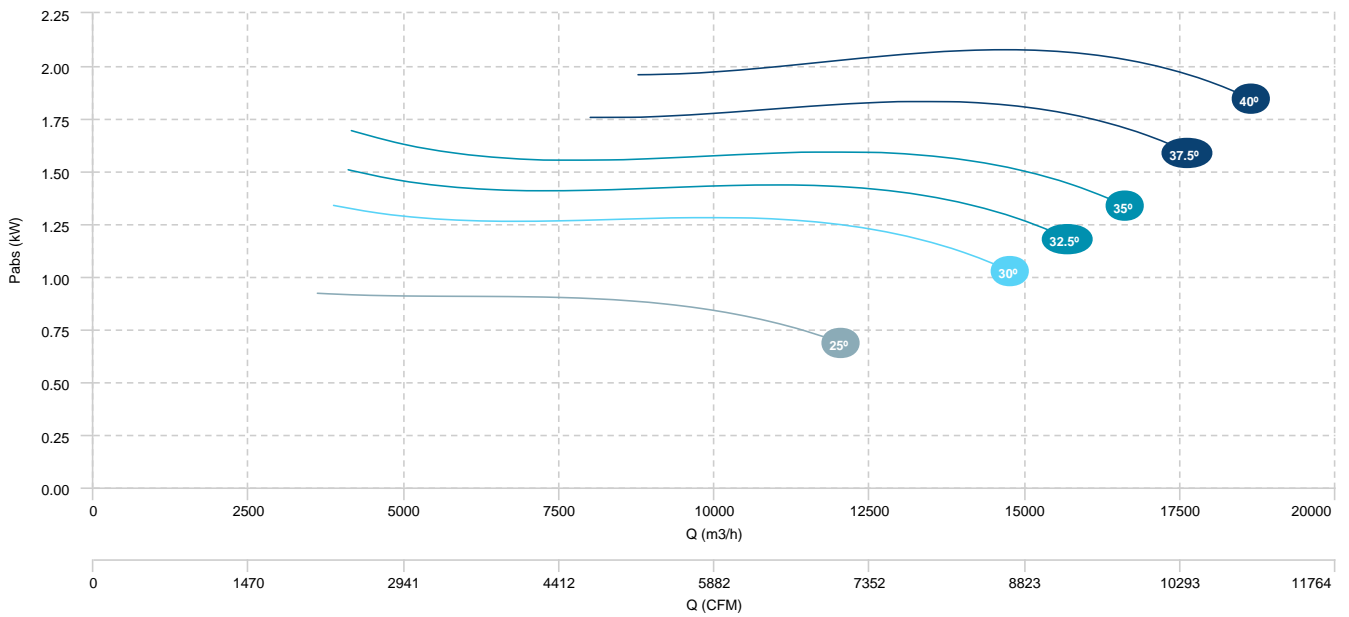

HM 63 T4 0,75kW (A2:9)	HM 63 T4 1,1kW (A2:9)	HM 63 T4 1,5kW (A2:9)
HM 63 T4 2,2kW (A2:9)	HM 63 T4 3kW (A2:9)	

## AIR FLOW - PRESSURE

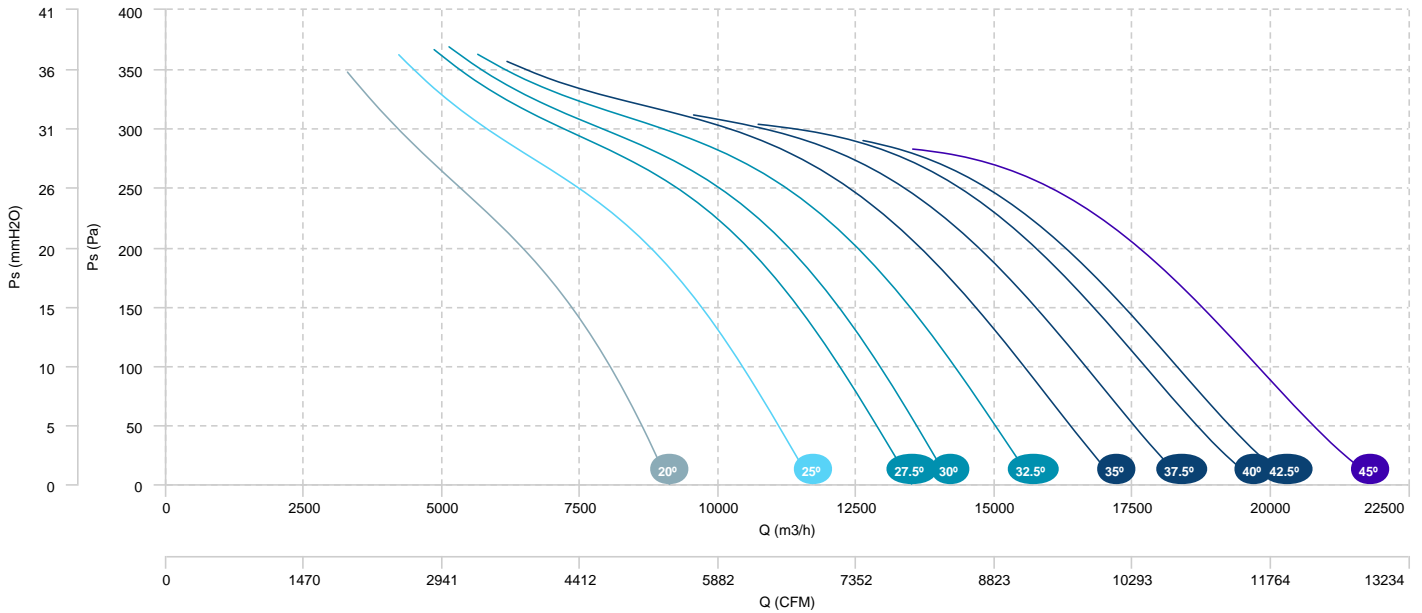

## AIR FLOW - ABSORBED POWER

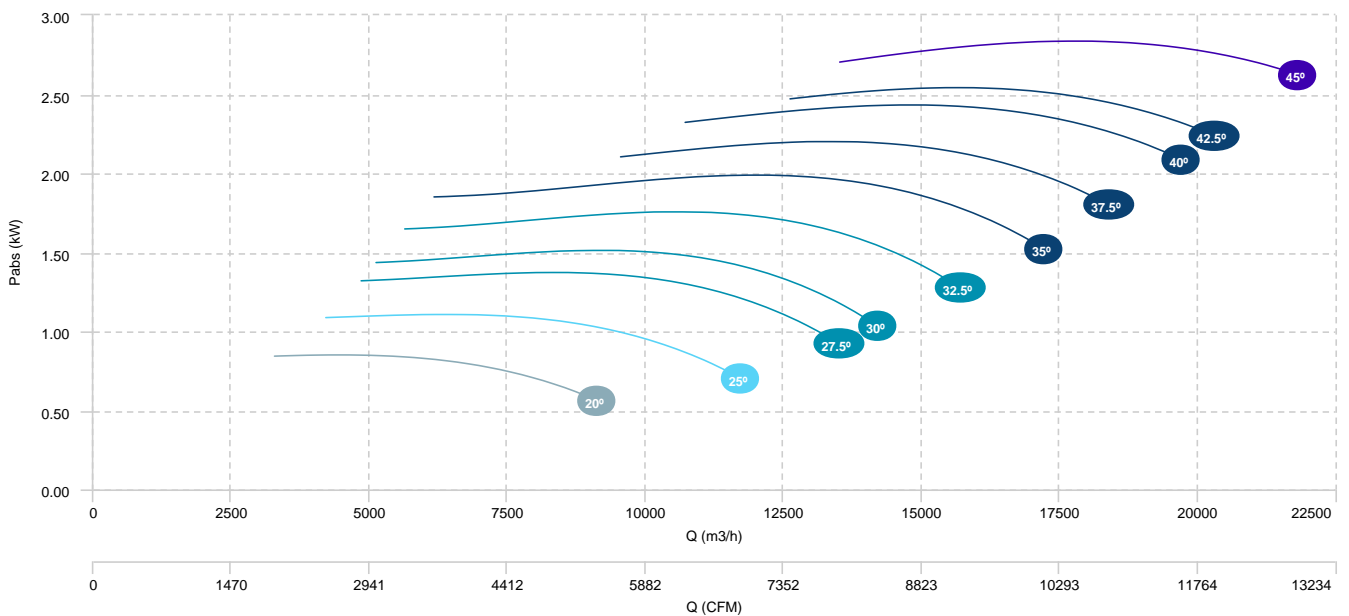

HM 63 T4 0,55kW (A2:6)	HM 63 T4 0,75kW (A2:6)	HM 63 T4 1,1kW (A2:6)
HM 63 T4 1,5kW (A2:6)	HM 63 T4 2,2kW (A2:6)	

## AIR FLOW - PRESSURE

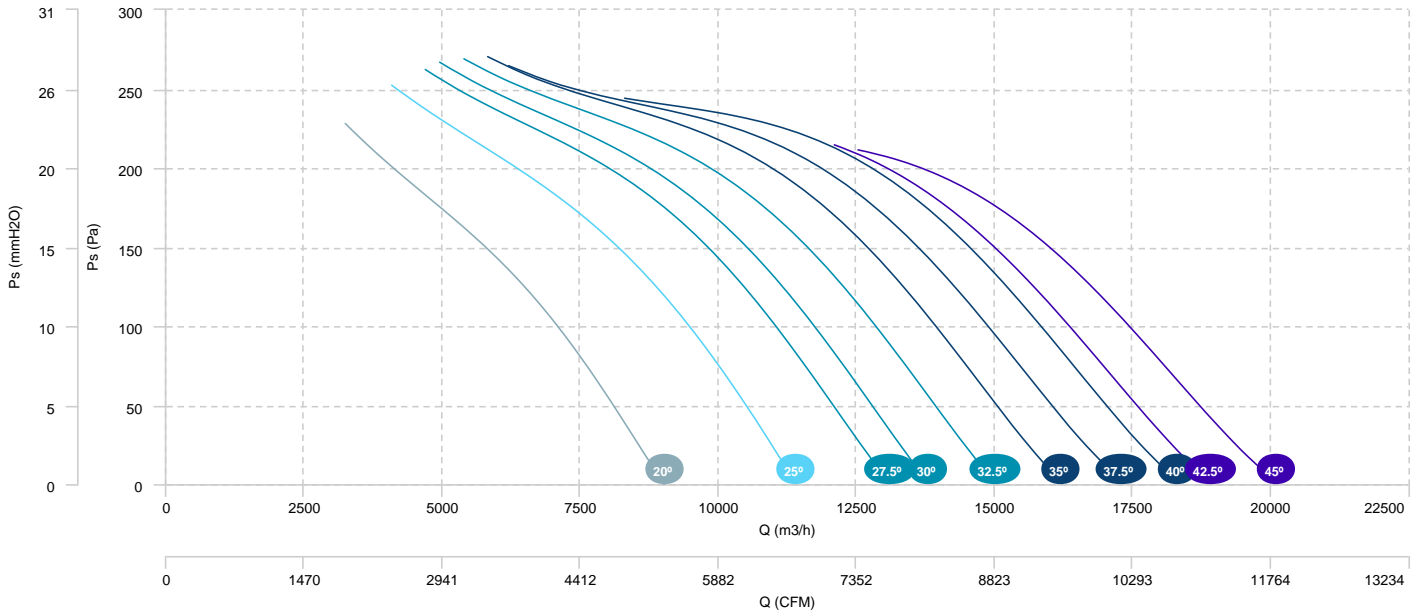

## AIR FLOW - ABSORBED POWER

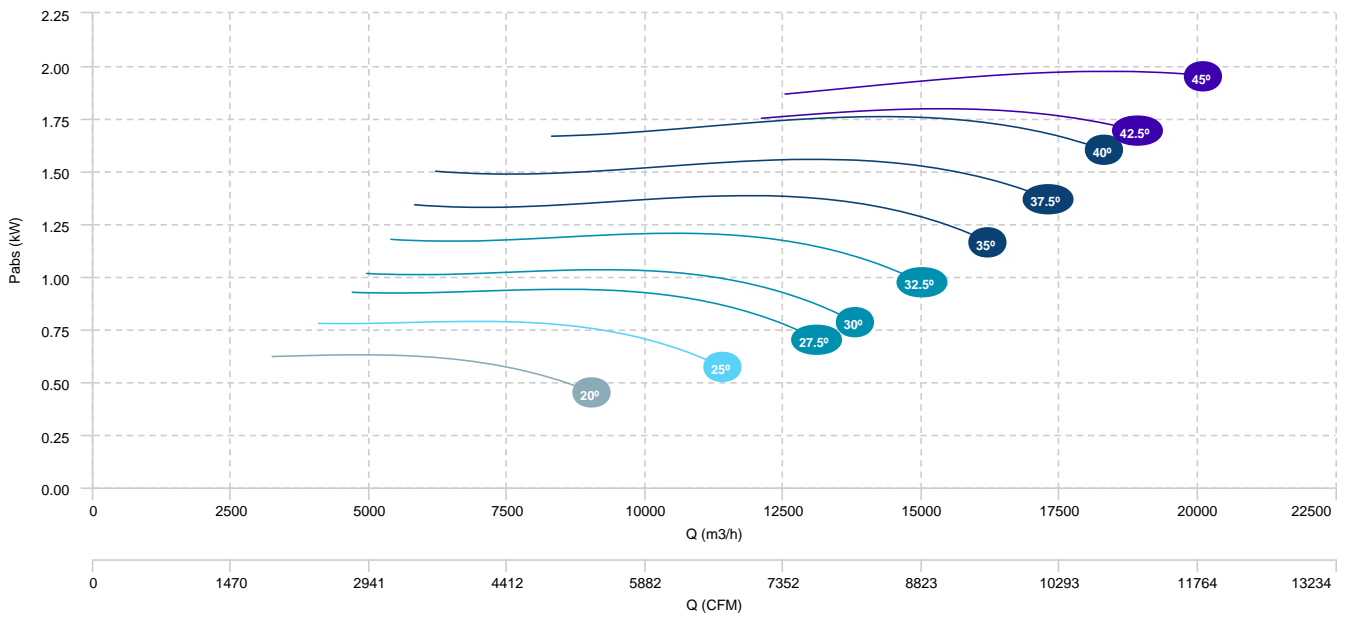



HM 63 T6 0,55kW (A2:9)

HM 63 T6 0,75kW (A2:9)

AIR FLOW - PRESSURE

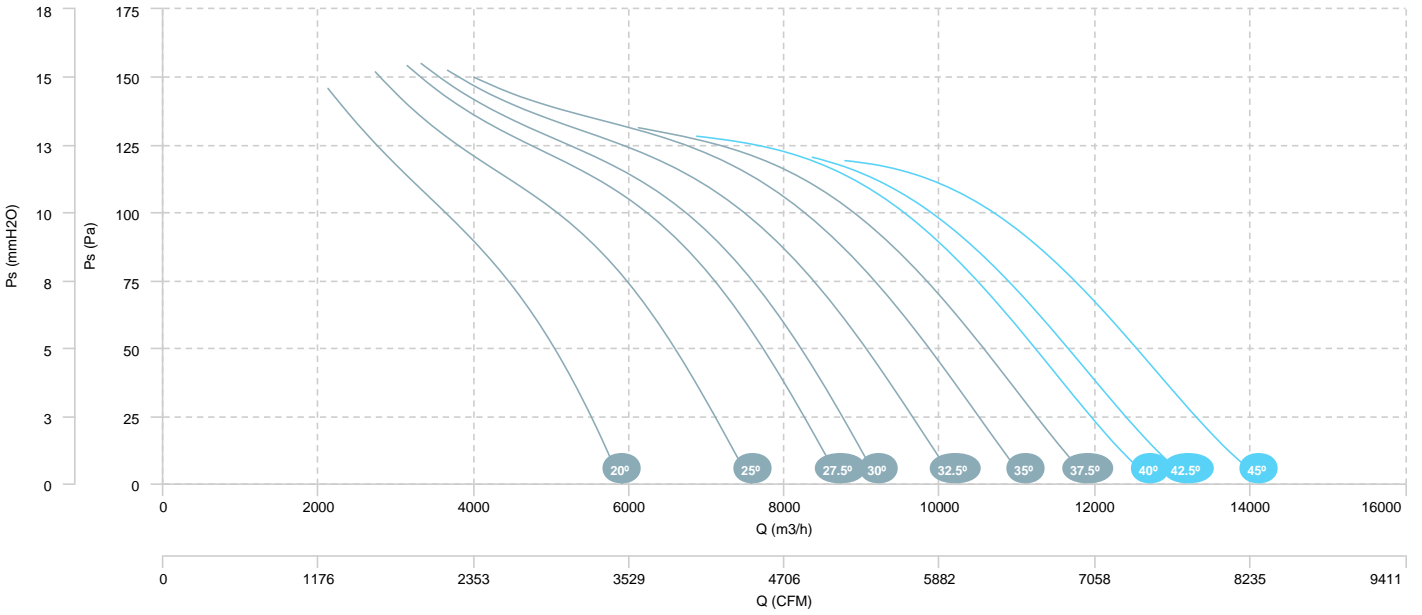

AIR FLOW - ABSORBED POWER

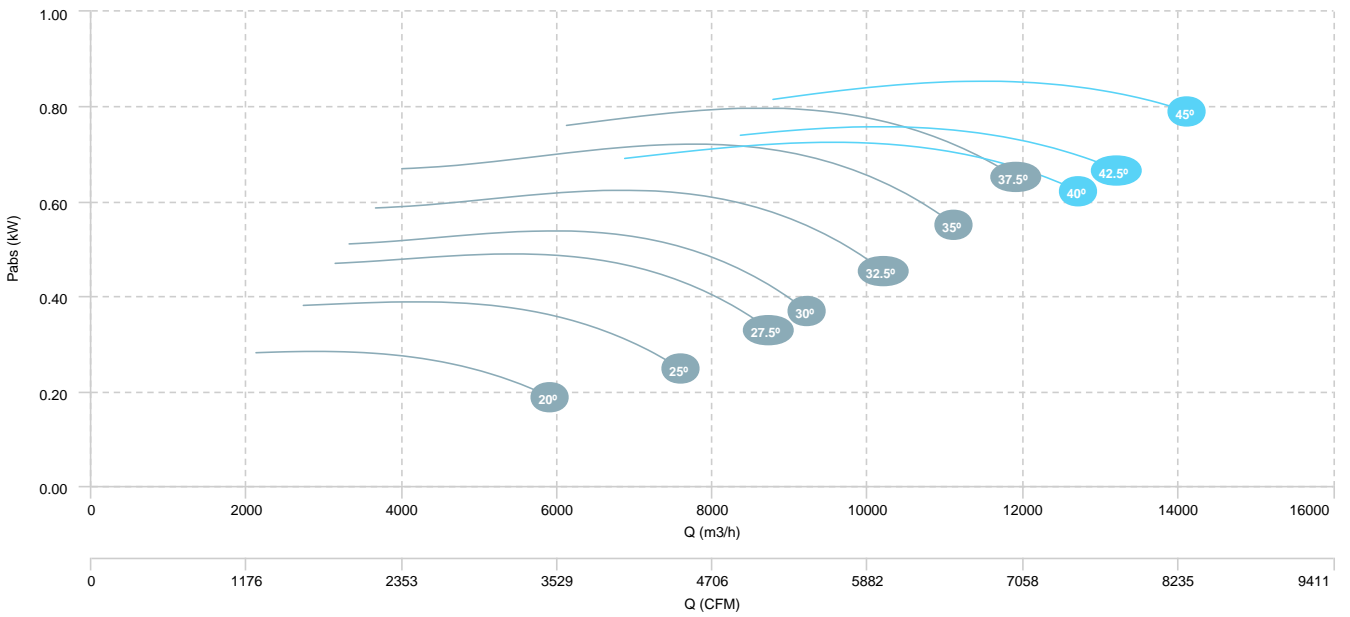

HM 63 T6 0,55KW (A2:6)

AIR FLOW - PRESSURE

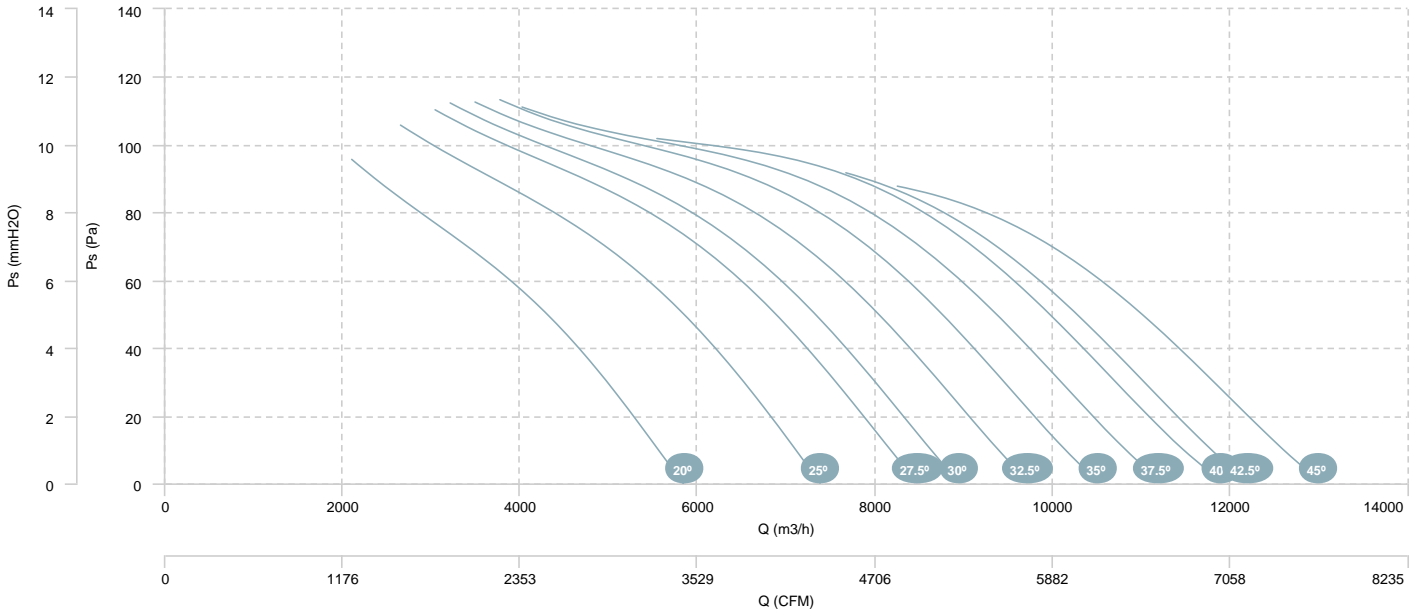

AIR FLOW - ABSORBED POWER



HM 63 T6 0,37kW (A5:6)

HM 63 T6 0,55kW (A5:6)

AIR FLOW - PRESSURE

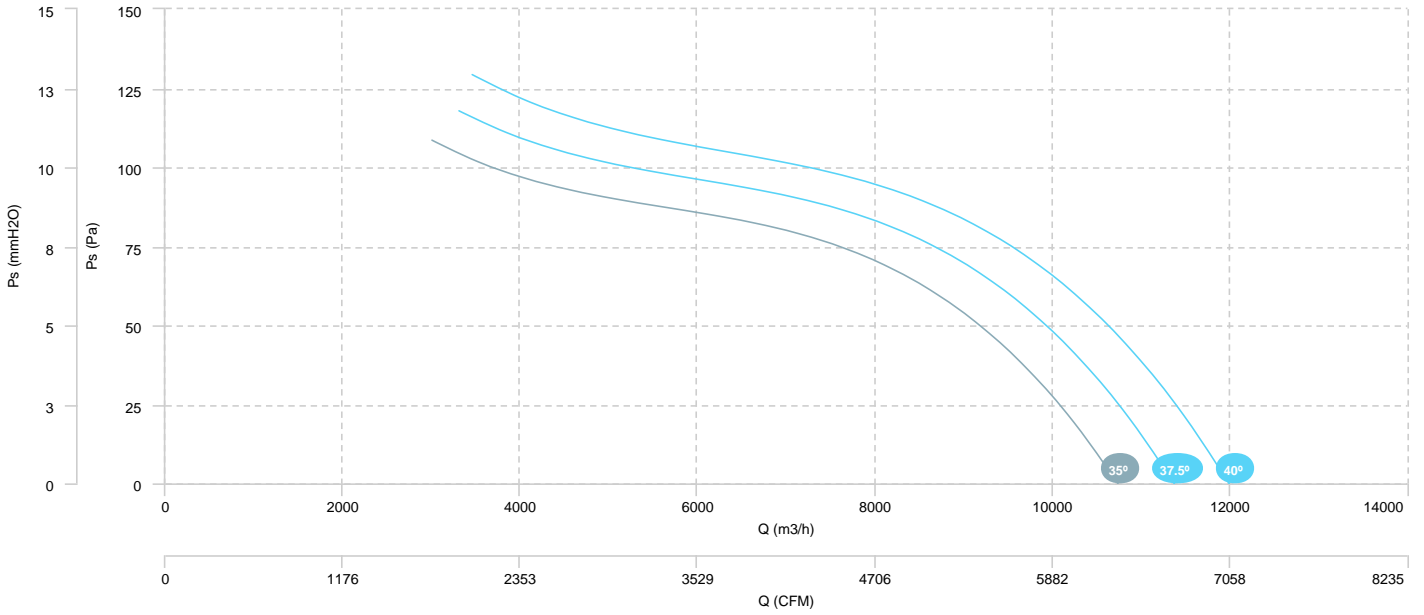

AIR FLOW - ABSORBED POWER

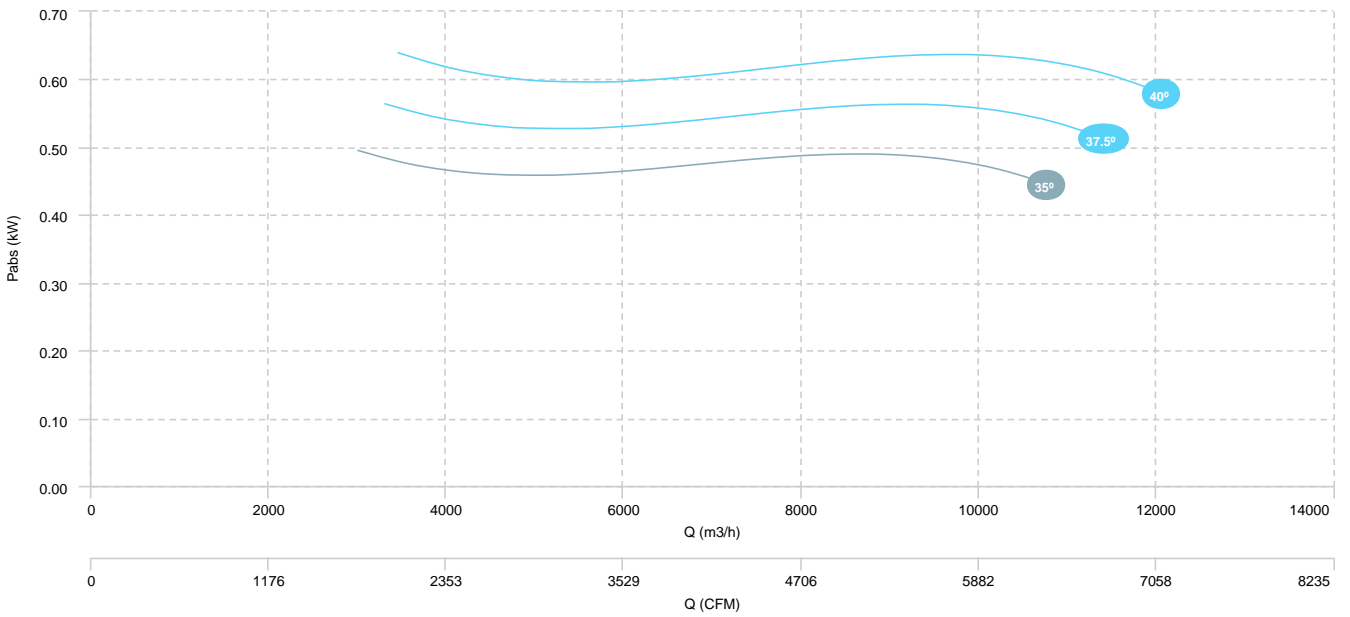

HM 63 T2/T4 8/1,85kW (A9:5)

HM 63 T2/T4 11/2,8kW (A9:5)

AIR FLOW - PRESSURE (2 poles)

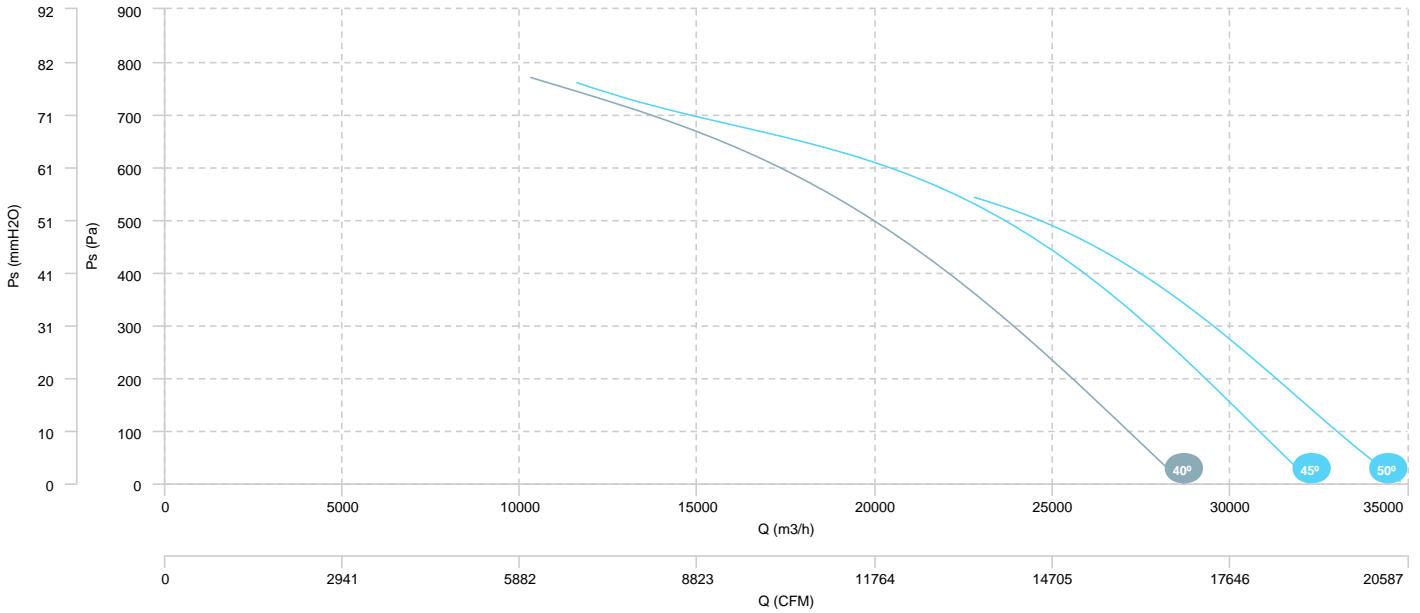

AIR FLOW - ABSORBED POWER (2 poles)

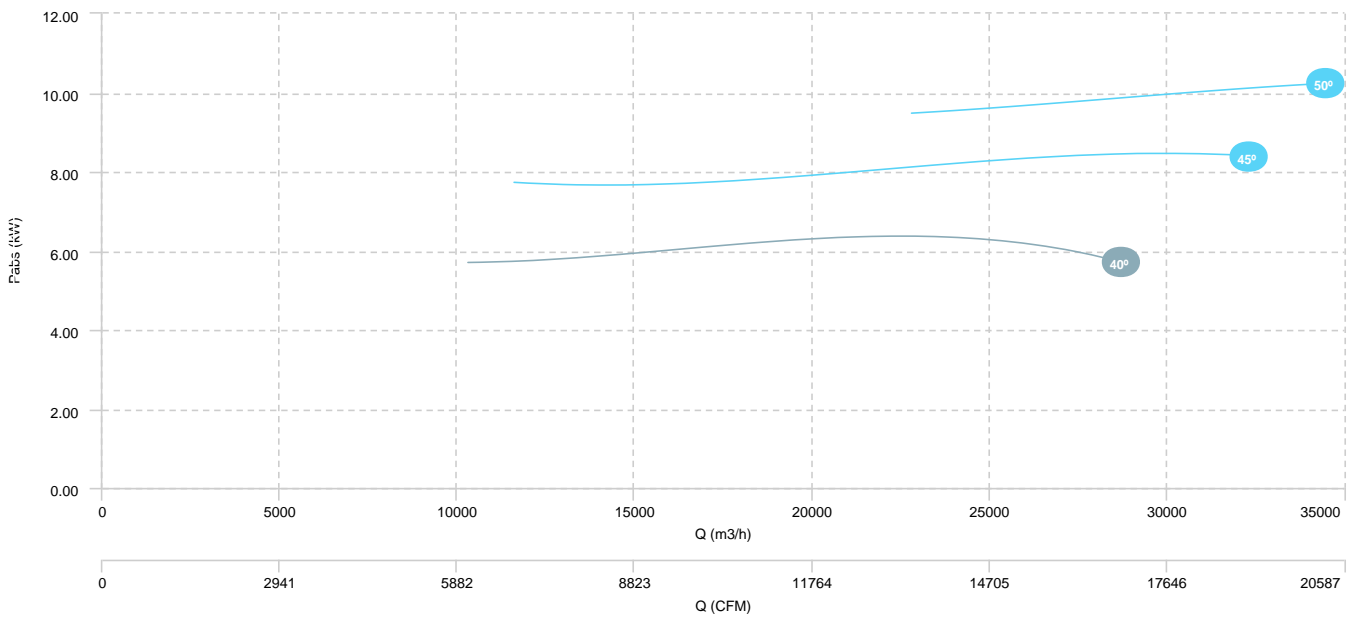

HM 63 T2/T4 8/1,85kW (A9:5)

HM 63 T2/T4 11/2,8kW (A9:5)

AIR FLOW - PRESSURE (4 poles)

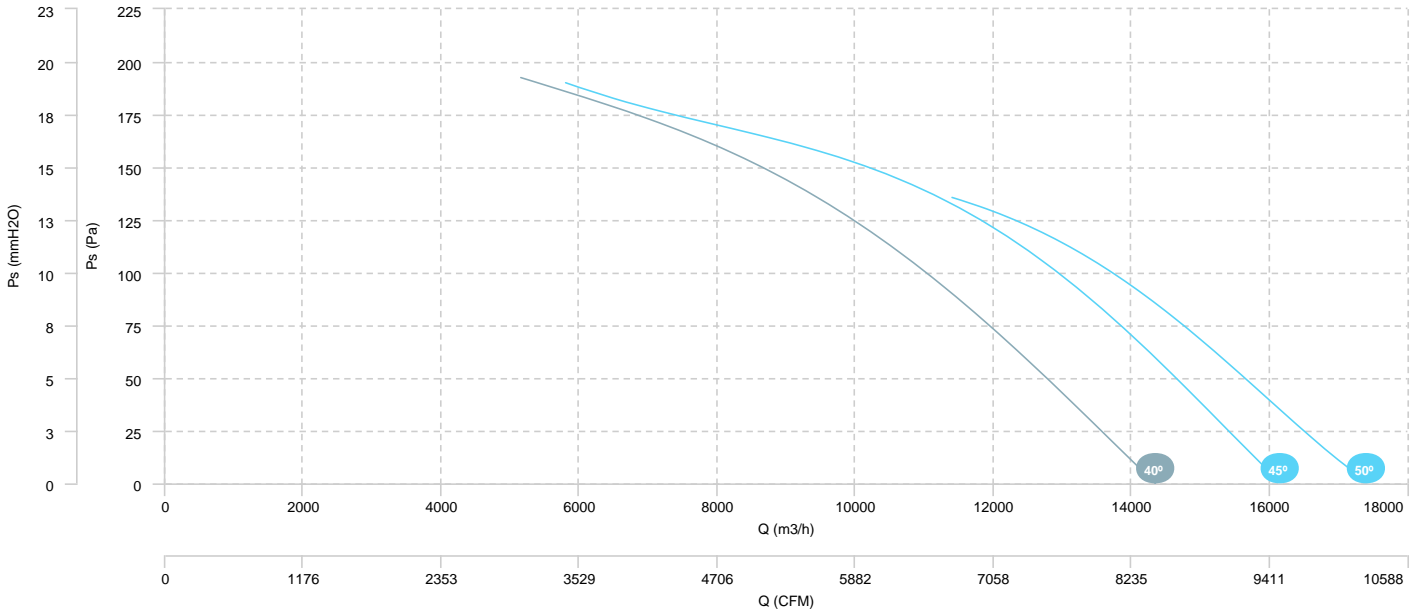

HM 63 T2/T4 5,5/1,5kW (A9:10)

HM 63 T2/T4 8/1,85kW (A9:10)

HM 63 T2/T4 11/3kW (A9:10)

HM 63 T2/T4 15/4kW (A9:10)

AIR FLOW - PRESSURE (2 poles)

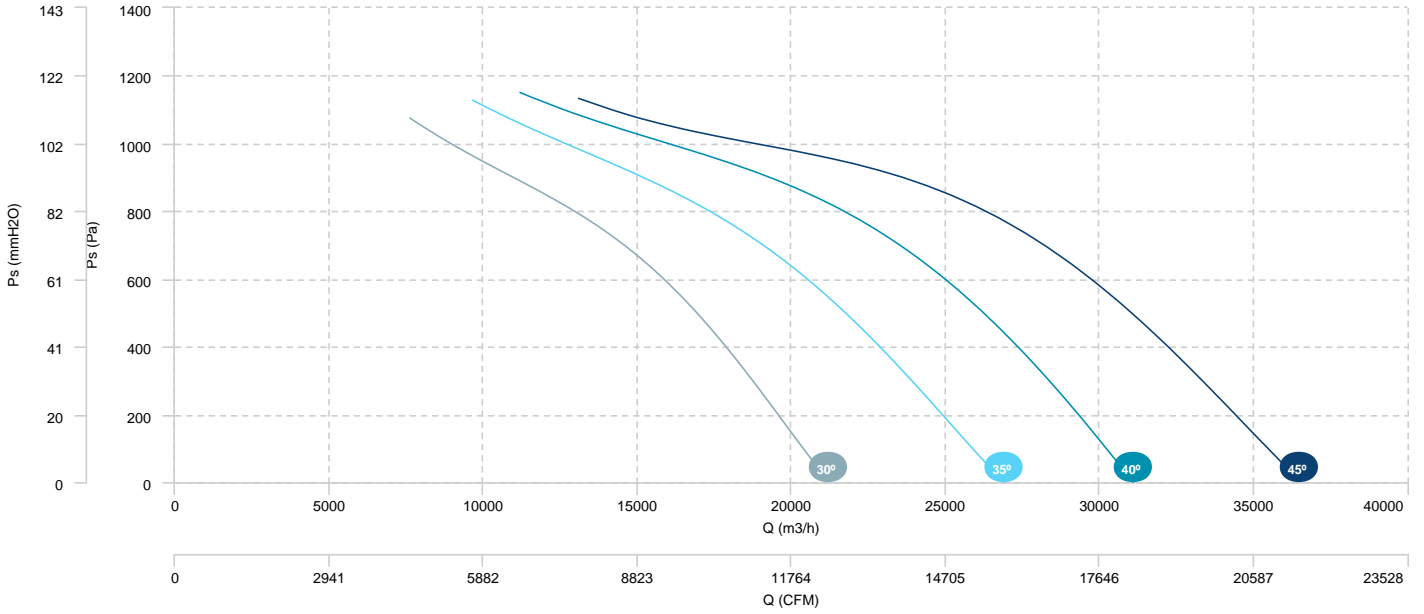

AIR FLOW - ABSORBED POWER (2 poles)

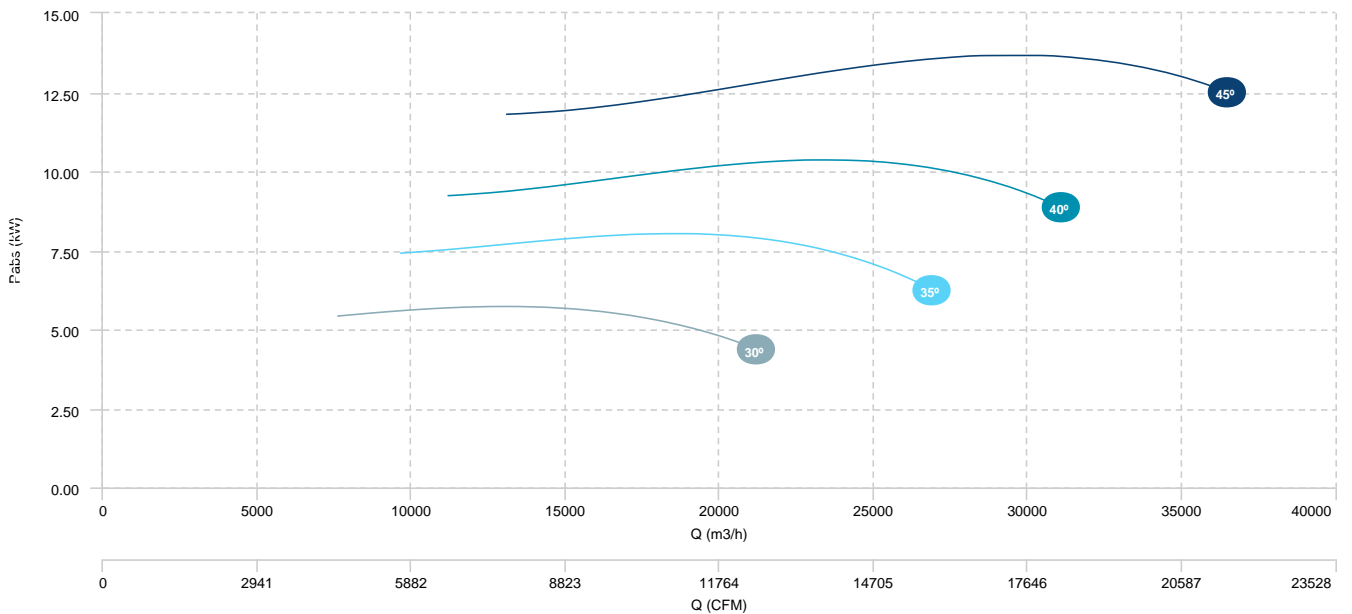

HM 63 T2/T4 5,5/1,5kW (A9:10)	HM 63 T2/T4 8/1,85kW (A9:10)	HM 63 T2/T4 11/3kW (A9:10)
HM 63 T2/T4 15/4kW (A9:10)		

## AIR FLOW - PRESSURE (4 poles)

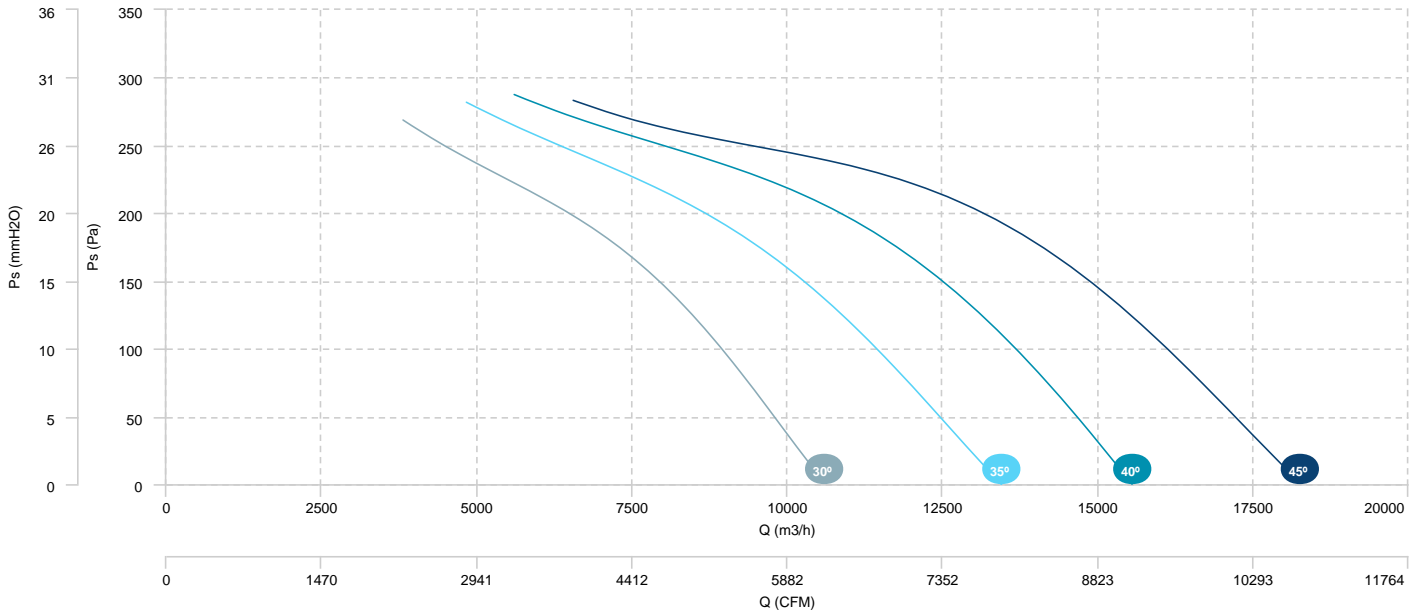

HM 63 T2/T4 1,5/0,37kW (A9:4)	HM 63 T2/T4 2,2/0,55kW (A9:4)	HM 63 T2/T4 3/0,75kW (A9:4)
HM 63 T2/T4 4,5/0,9kW (A9:4)		

## AIR FLOW - PRESSURE (2 poles)

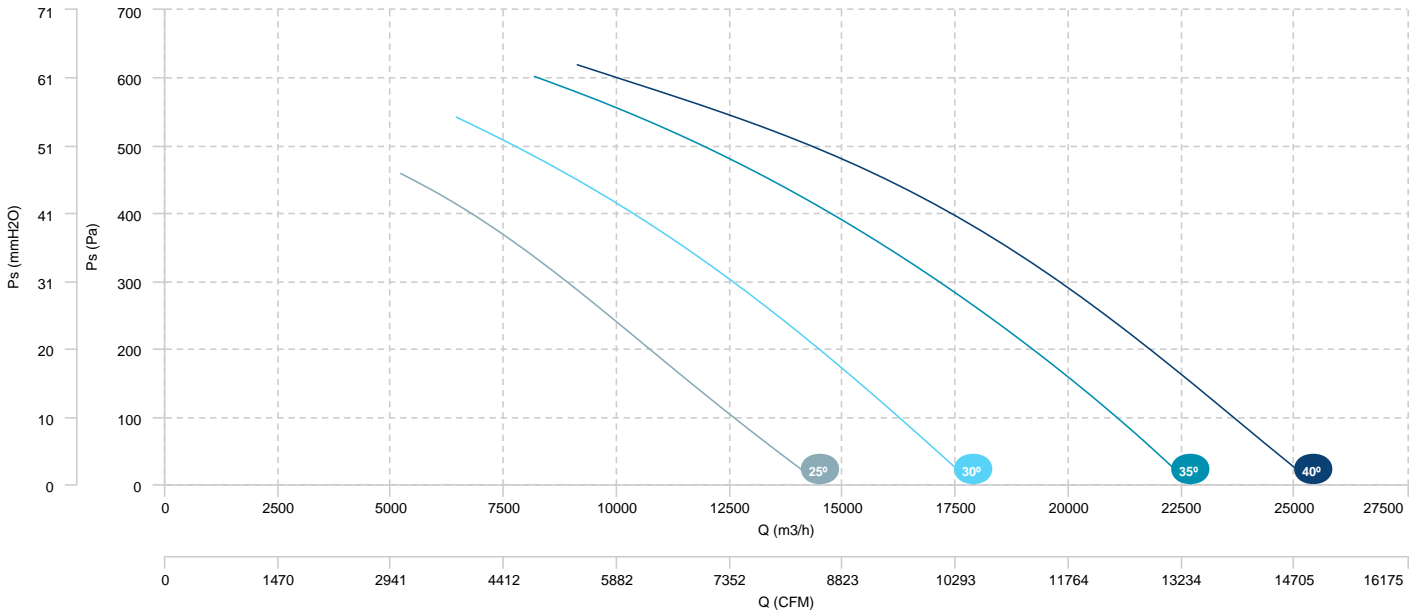

## AIR FLOW - ABSORBED POWER (2 poles)

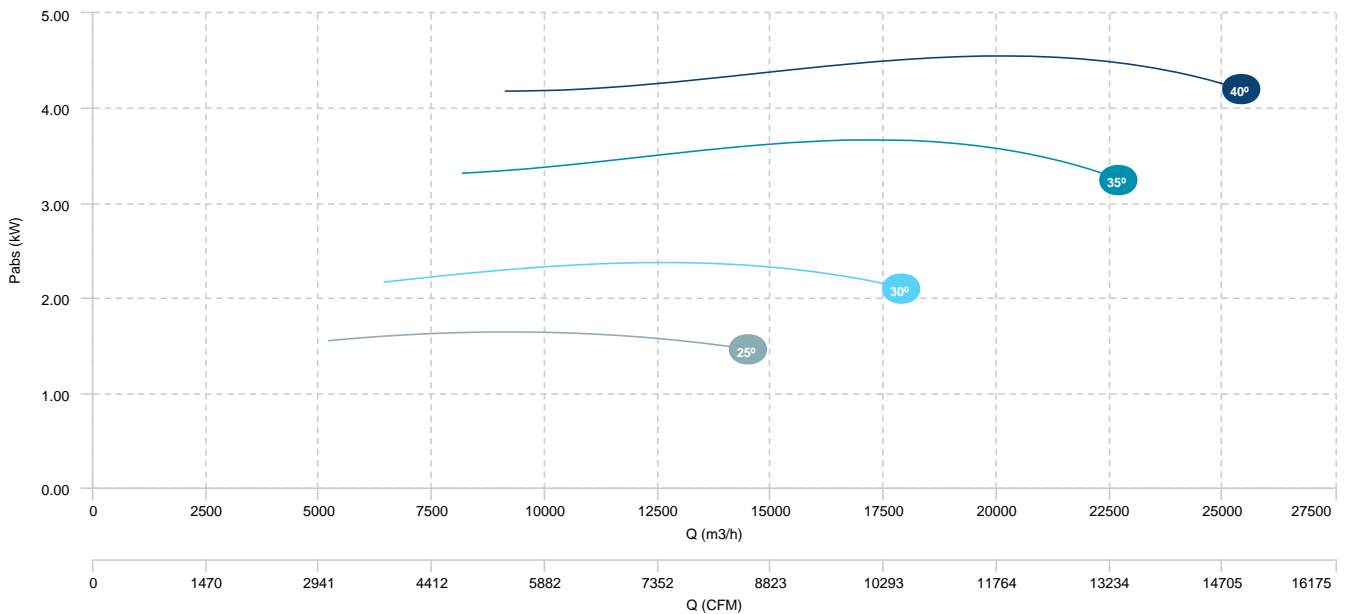



HM 63 T2/T4 1,5/0,37kW (A9:4)	HM 63 T2/T4 2,2/0,55kW (A9:4)	HM 63 T2/T4 3/0,75kW (A9:4)
HM 63 T2/T4 4,5/0,9kW (A9:4)		

AIR FLOW - PRESSURE (4 poles)

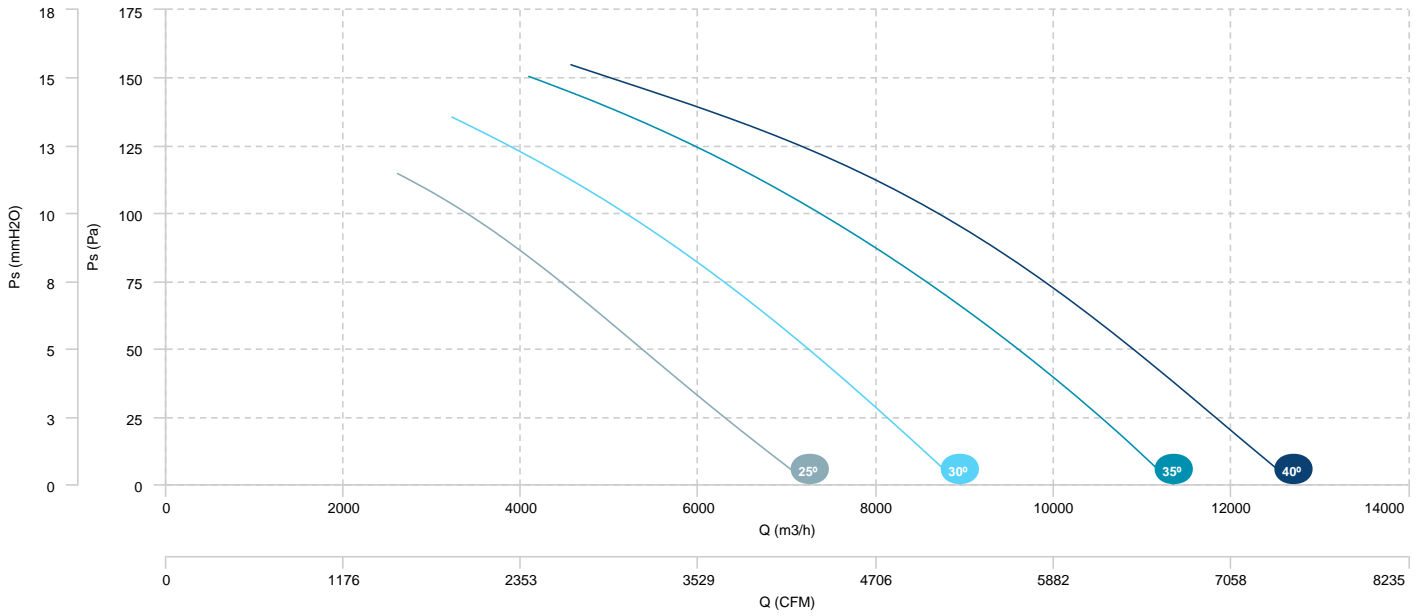

HM 63 T2/T4 3/0,75kW (A9:8)

HM 63 T2/T4 4,5/0,9kW (A9:8)

AIR FLOW - PRESSURE (2 poles)

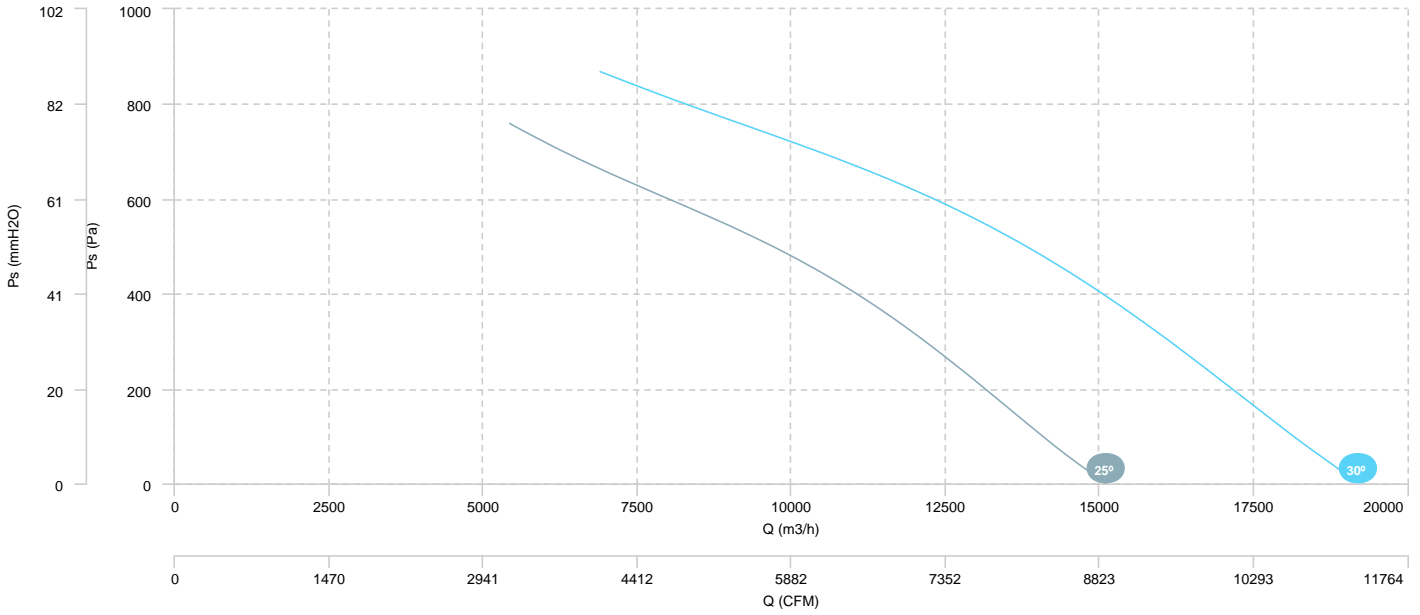

AIR FLOW - ABSORBED POWER (2 poles)

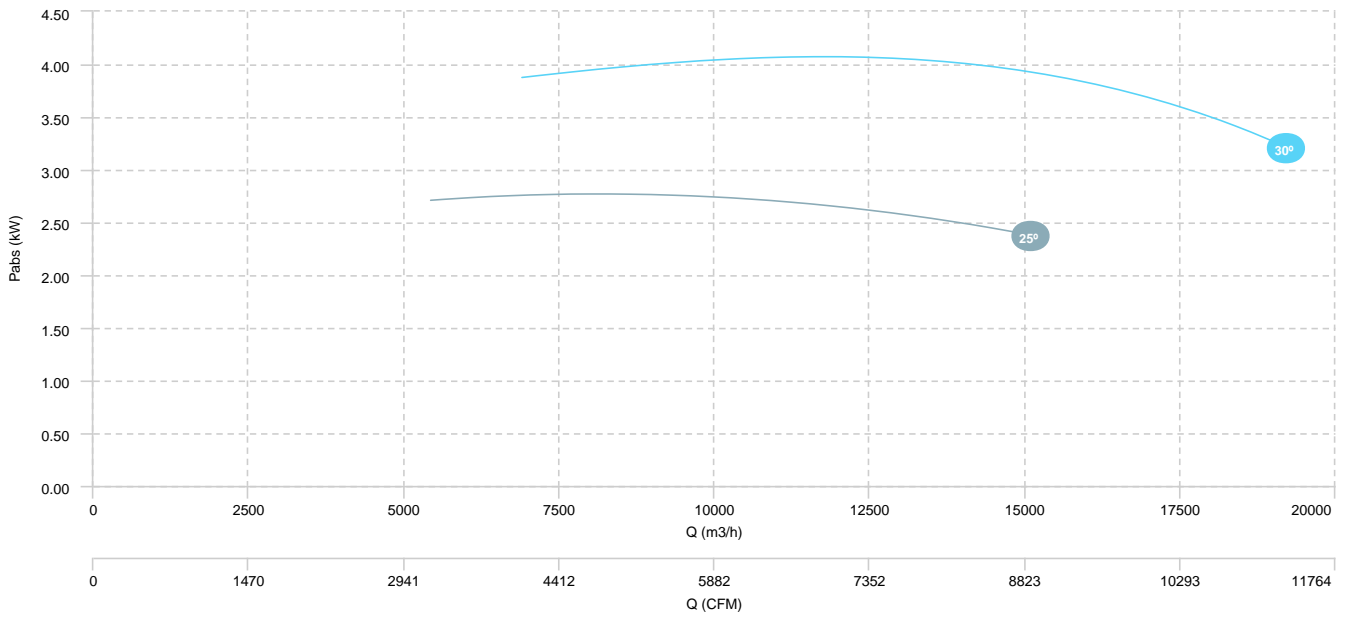

HM 63 T2/T4 3/0,75kW (A9:8)

HM 63 T2/T4 4,5/0,9kW (A9:8)

AIR FLOW - PRESSURE (4 poles)

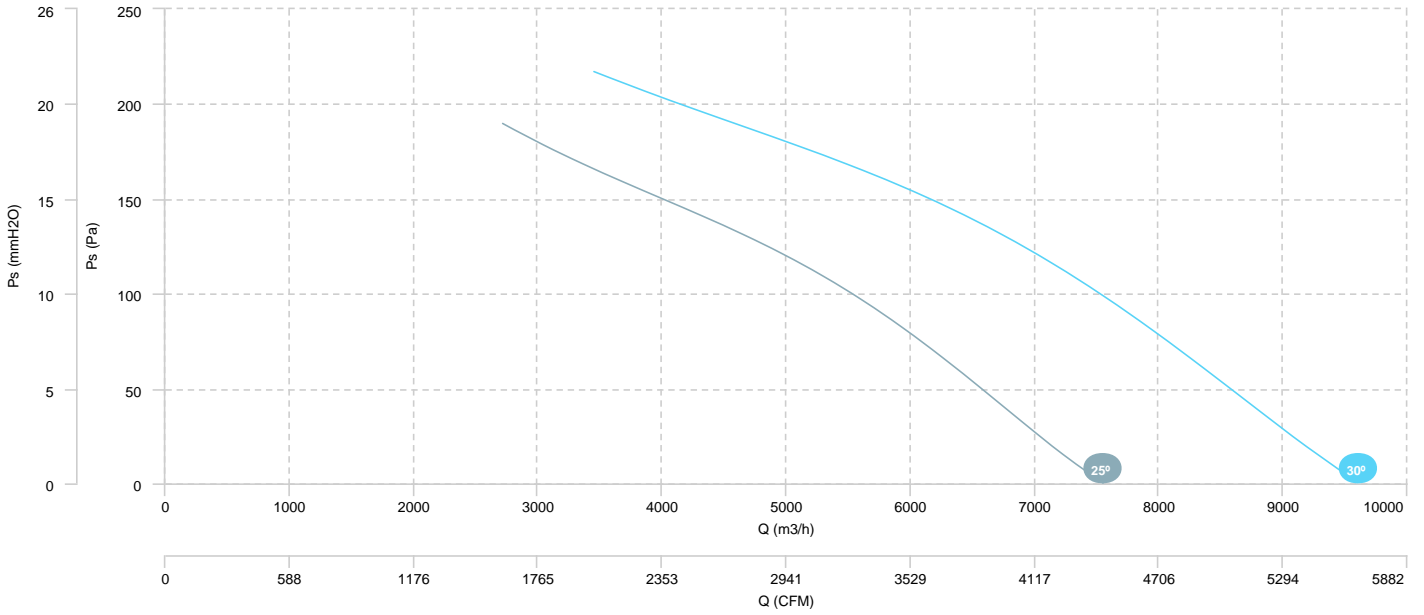

HM 63 T4/T6 0,75/0,25kW (A2:9)	HM 63 T4/T6 1,1/0,37kW (A2:9)	HM 63 T4/T6 1,5/0,5kW (A2:9)
HM 63 T4/T6 2,2/0,6kW (A2:9)	HM 63 T4/T6 3/0,9kW (A2:9)	

## AIR FLOW - PRESSURE (4 poles)

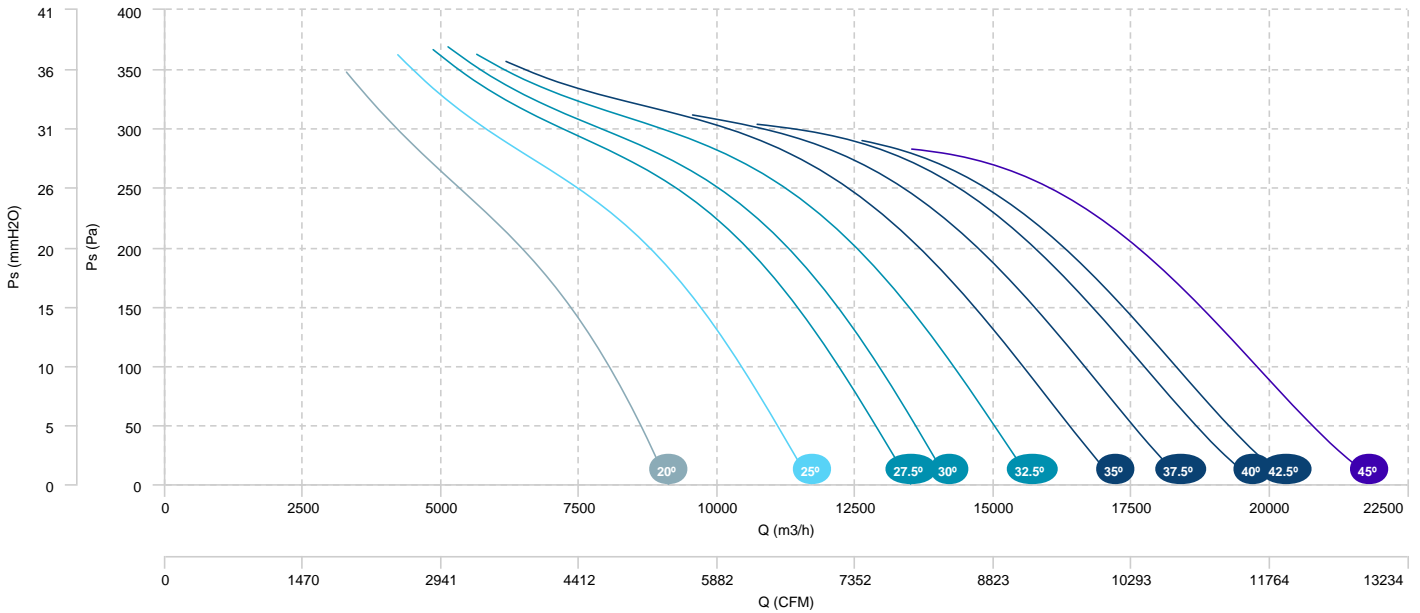

## AIR FLOW - ABSORBED POWER (4 poles)

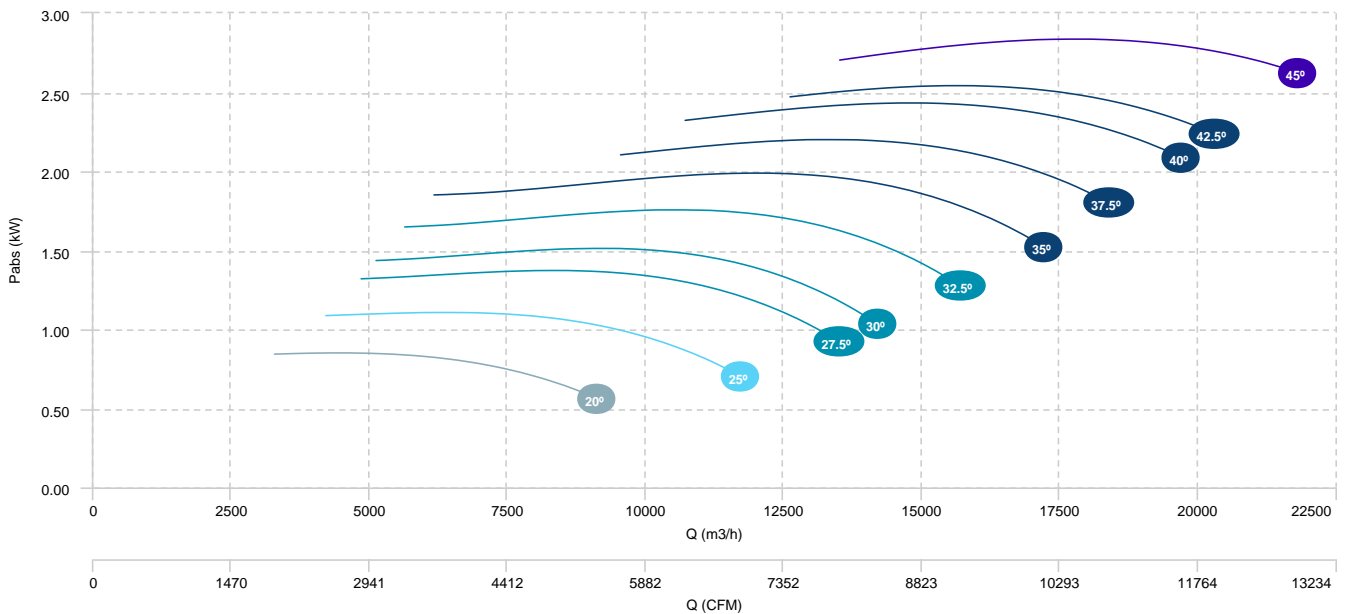

HM 63 T4/T6 0,75/0,25kW (A2:9)	HM 63 T4/T6 1,1/0,37kW (A2:9)	HM 63 T4/T6 1,5/0,5kW (A2:9)
HM 63 T4/T6 2,2/0,6kW (A2:9)	HM 63 T4/T6 3/0,9kW (A2:9)	

**AIR FLOW - PRESSURE (6 poles)**

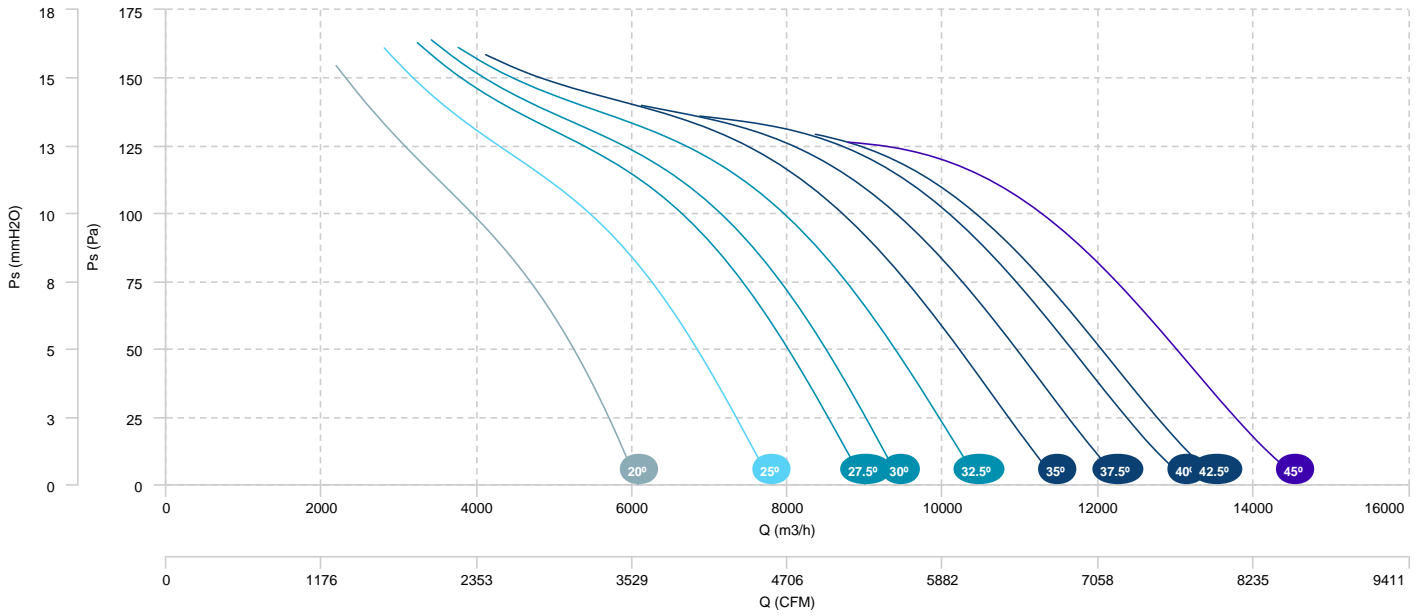

HM 63 T4/T6 0,75/0,25kW (A5:6)

HM 63 T4/T6 1,1/0,37kW (A5:6)

HM 63 T4/T6 1,5/0,5kW (A5:6)

HM 63 T4/T6 2,2/0,6kW (A5:6)

## AIR FLOW - PRESSURE (4 poles)

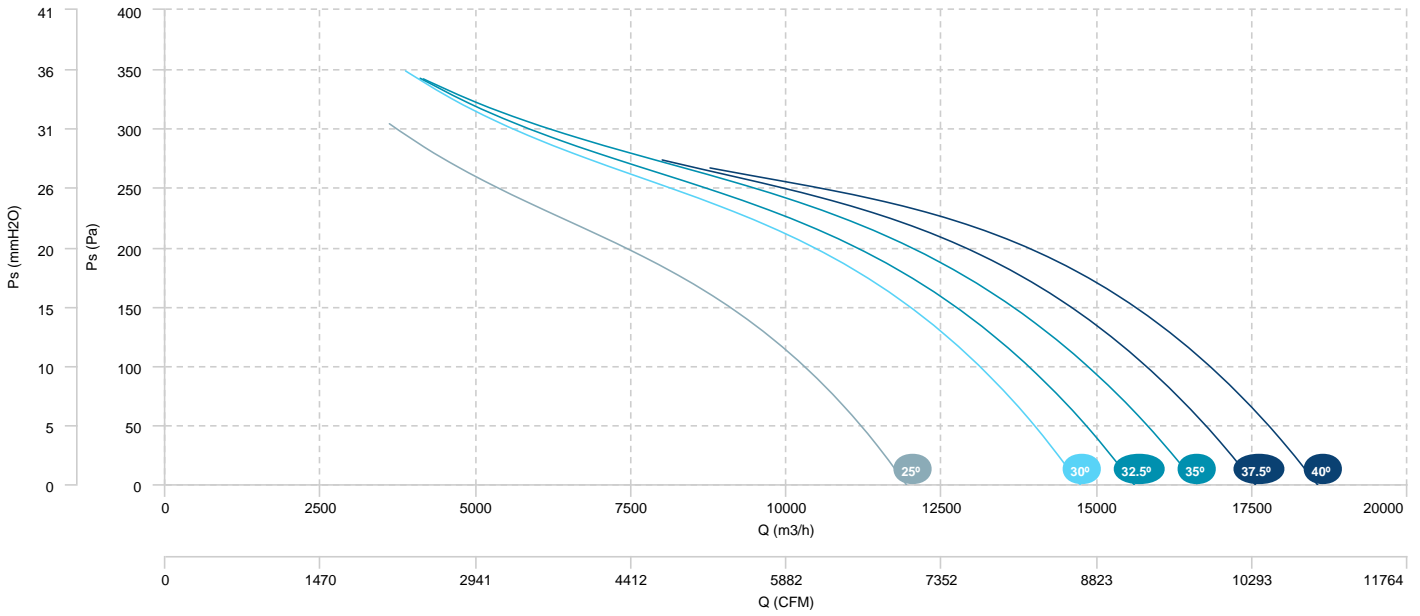

## AIR FLOW - ABSORBED POWER (4 poles)

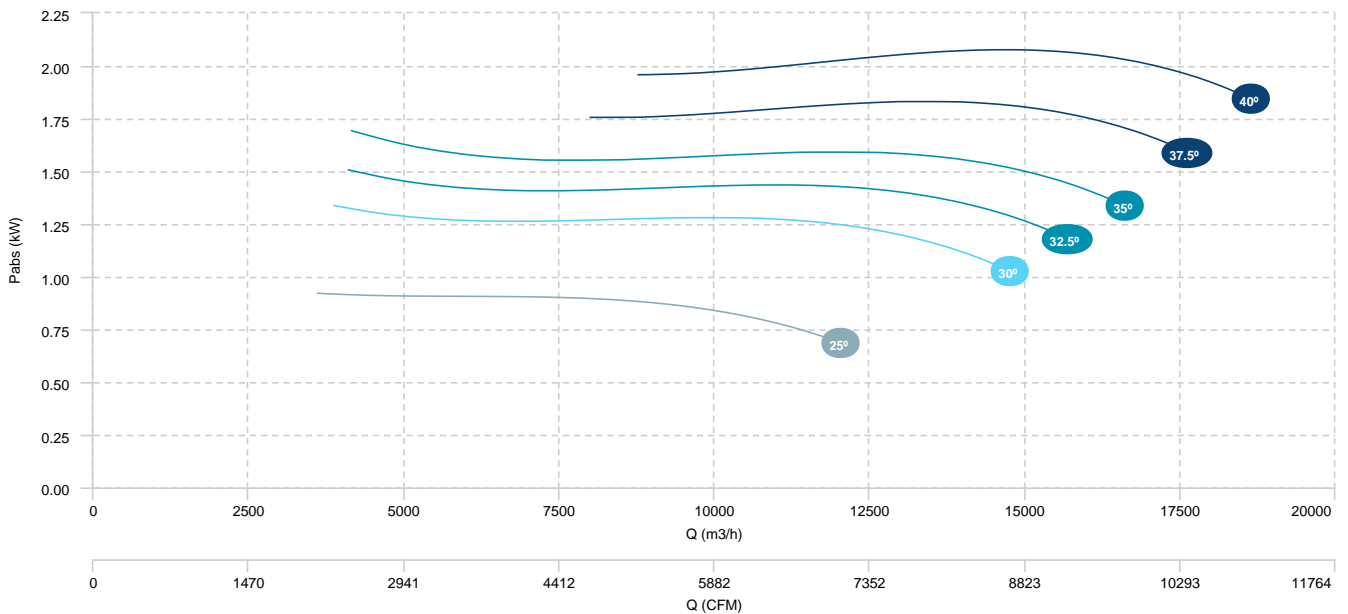

HM 63 T4/T6 0,75/0,25kW (A5:6)	HM 63 T4/T6 1,1/0,37kW (A5:6)	HM 63 T4/T6 1,5/0,5kW (A5:6)
HM 63 T4/T6 2,2/0,6kW (A5:6)		

## AIR FLOW - PRESSURE (6 poles)

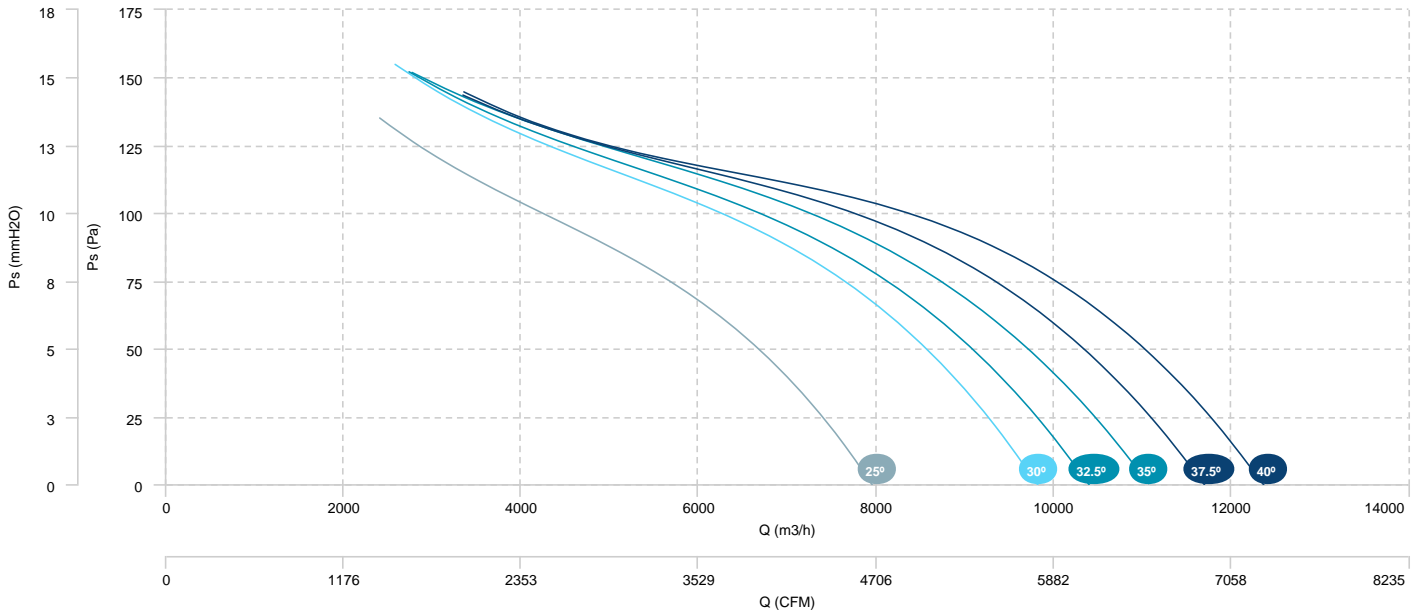

HM 63 T4/T6 0,55/0,18kW (A2:6)	HM 63 T4/T6 0,75/0,25kW (A2:6)	HM 63 T4/T6 1,1/0,37kW (A2:6)
HM 63 T4/T6 1,5/0,5kW (A2:6)	HM 63 T4/T6 2,2/0,6kW (A2:6)	

## AIR FLOW - PRESSURE (4 poles)

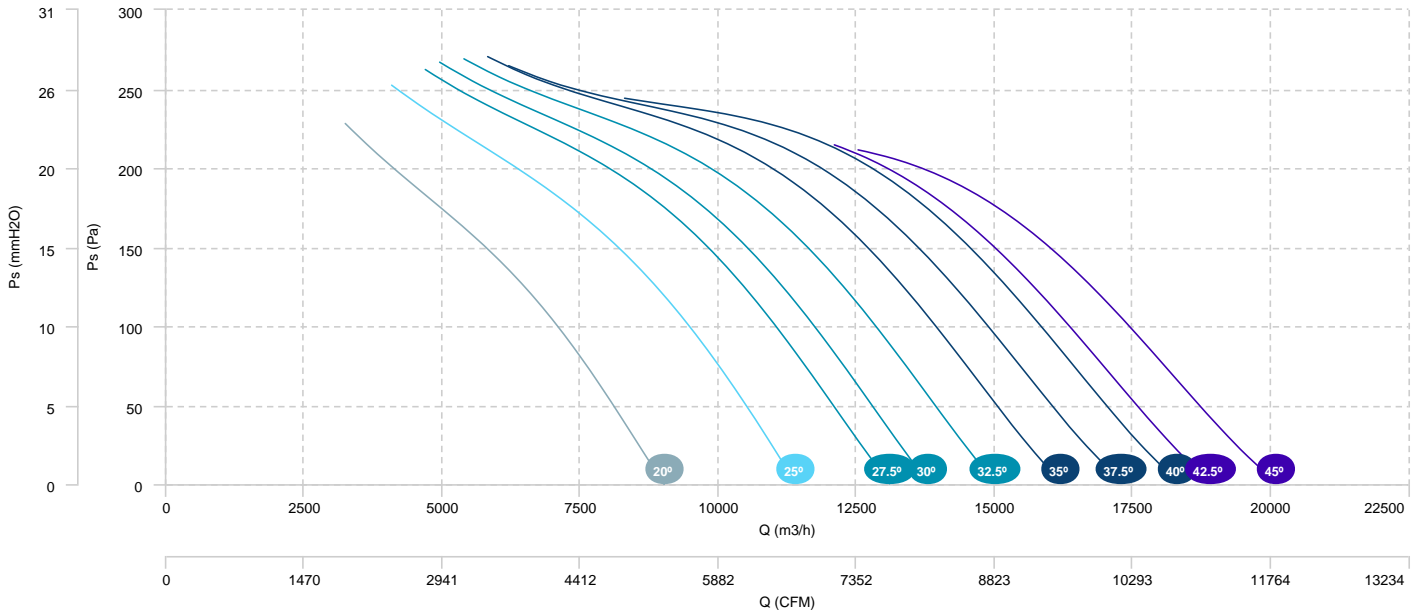

## AIR FLOW - ABSORBED POWER (4 poles)

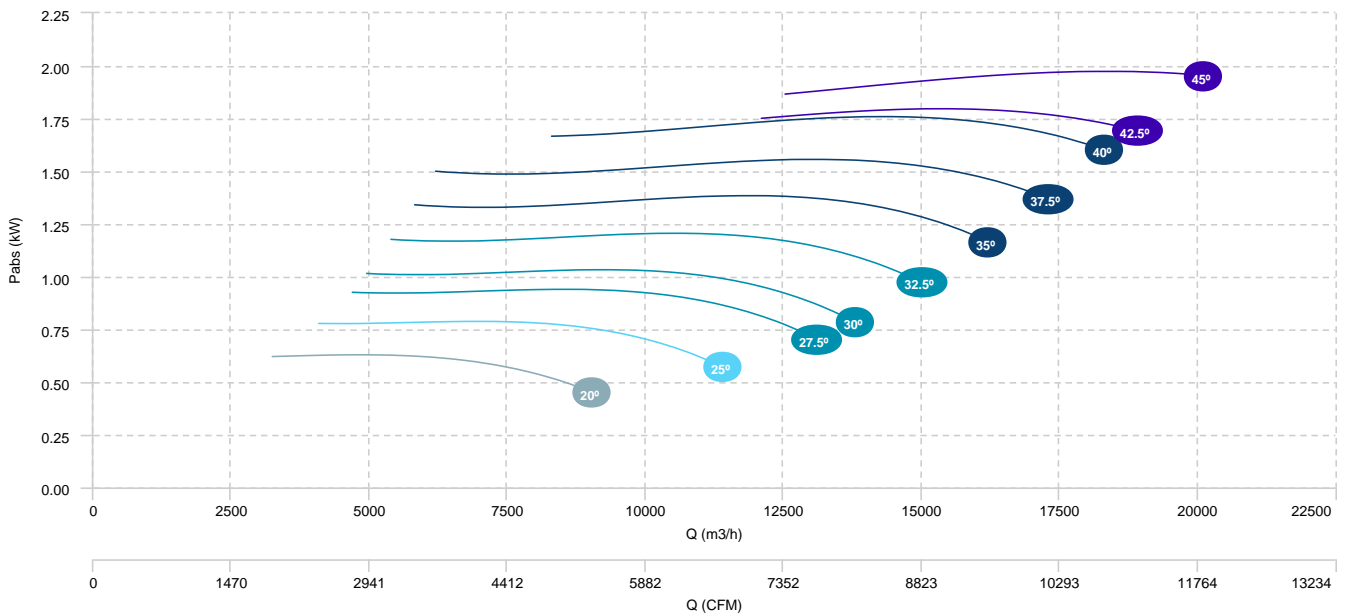



HM 63 T4/T6 0,55/0,18kW (A2:6)	HM 63 T4/T6 0,75/0,25kW (A2:6)	HM 63 T4/T6 1,1/0,37kW (A2:6)
HM 63 T4/T6 1,5/0,5kW (A2:6)	HM 63 T4/T6 2,2/0,6kW (A2:6)	

AIR FLOW - PRESSURE (6 poles)

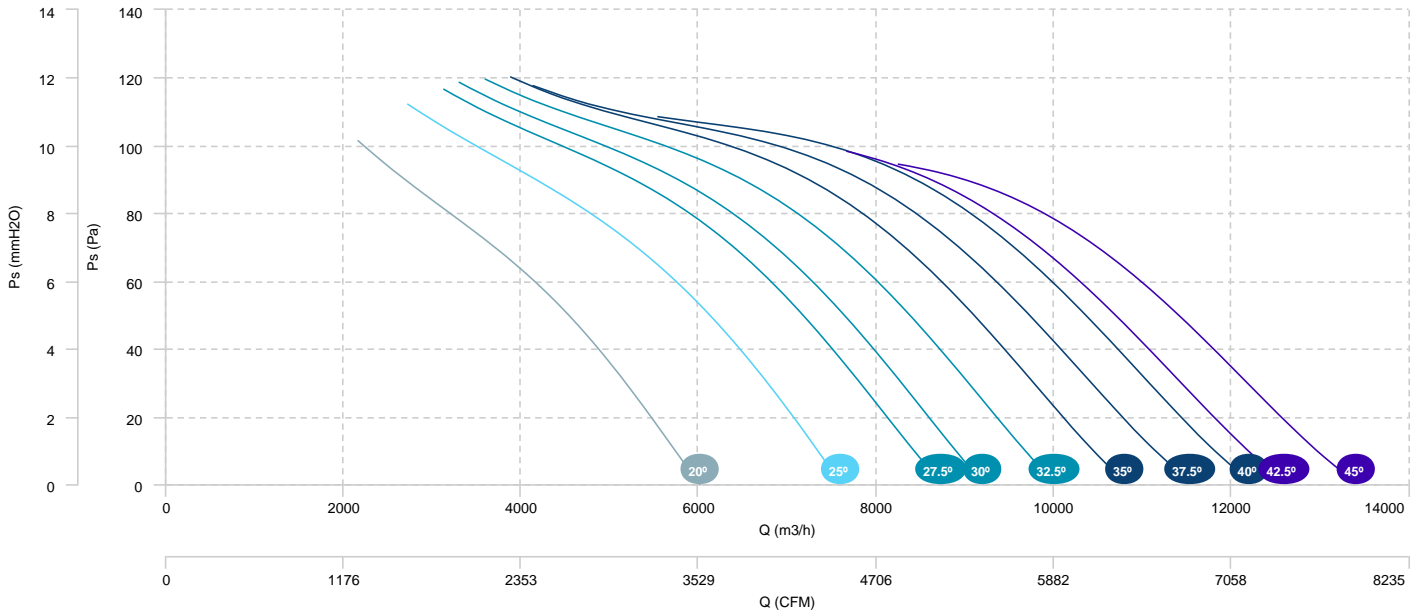

HM 63 T4/T8 0,75/0,12kW (A5:6)

HM 63 T4/T8 1,1/0,18kW (A5:6)

HM 63 T4/T8 1,5/0,25kW (A5:6)

HM 63 T4/T8 2,2/0,37kW (A5:6)

## AIR FLOW - PRESSURE (4 poles)

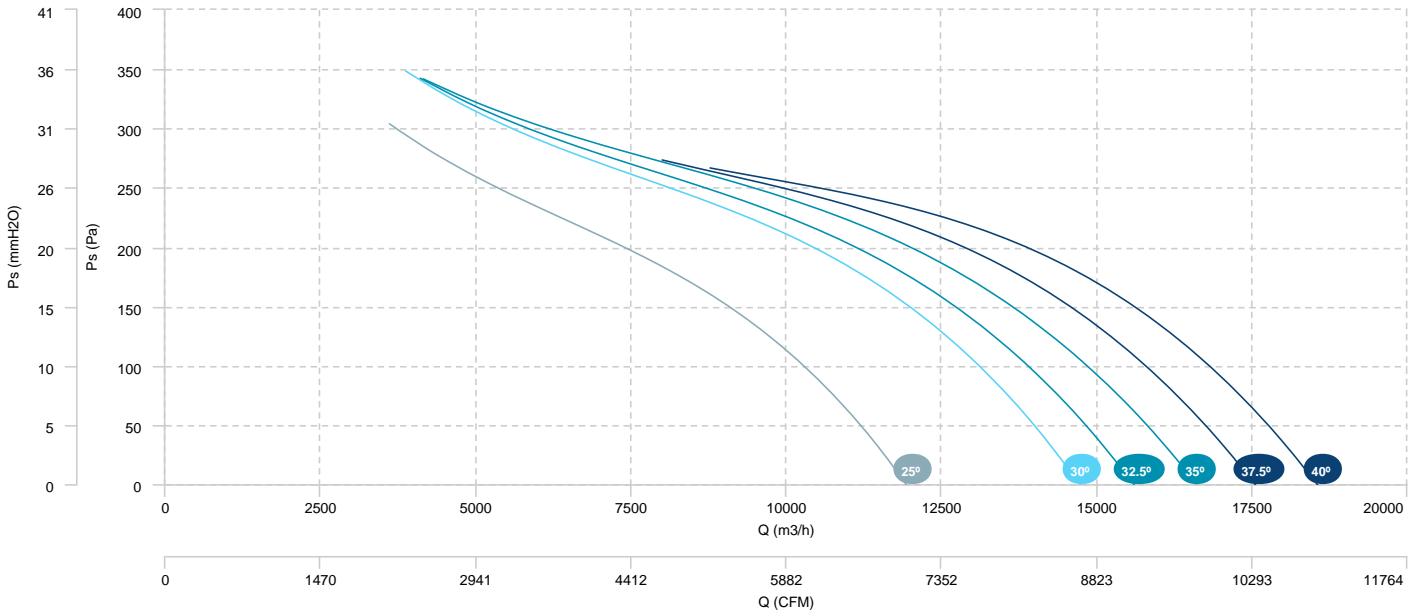

## AIR FLOW - ABSORBED POWER (4 poles)

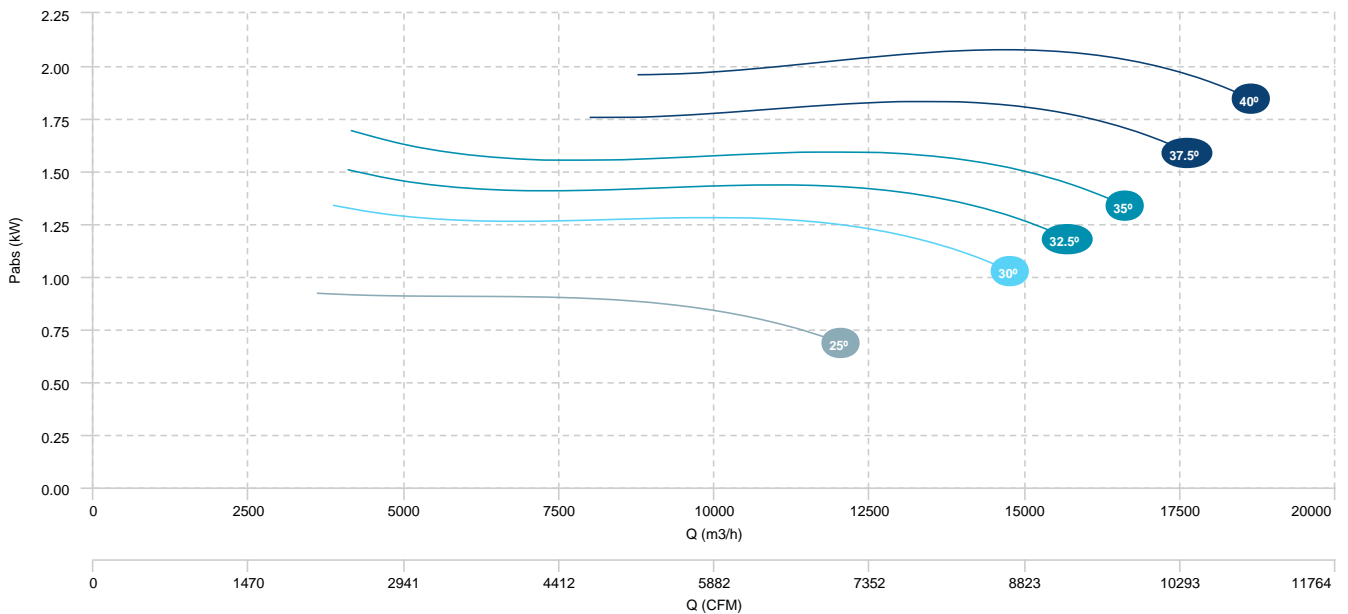

HM 63 T4/T8 0,75/0,12kW (A5:6)  
 HM 63 T4/T8 2,2/0,37kW (A5:6)

HM 63 T4/T8 1,1/0,18kW (A5:6)

HM 63 T4/T8 1,5/0,25kW (A5:6)

## AIR FLOW - PRESSURE (8 poles)

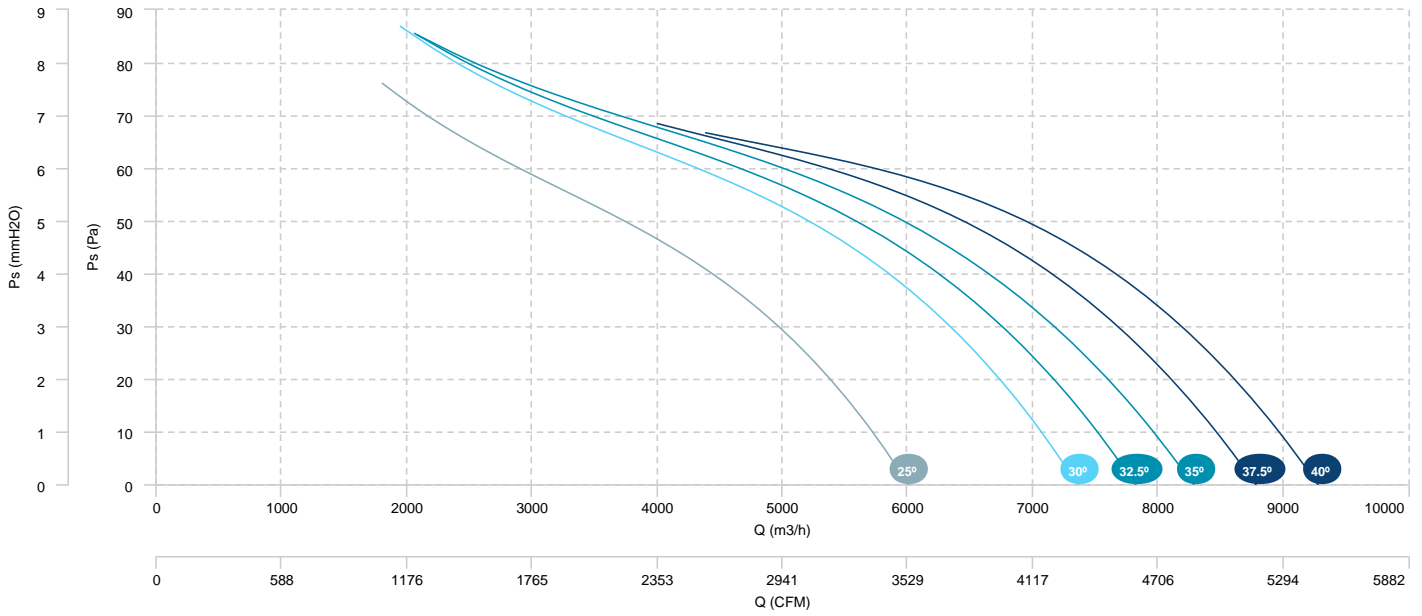

HM 63 T4/T8 0,75/0,12kW (A2:9)	HM 63 T4/T8 1,1/0,18kW (A2:9)	HM 63 T4/T8 1,5/0,25kW (A2:9)
HM 63 T4/T8 2,2/0,37kW (A2:9)	HM 63 T4/T8 3/0,55kW (A2:9)	

## AIR FLOW - PRESSURE (4 poles)

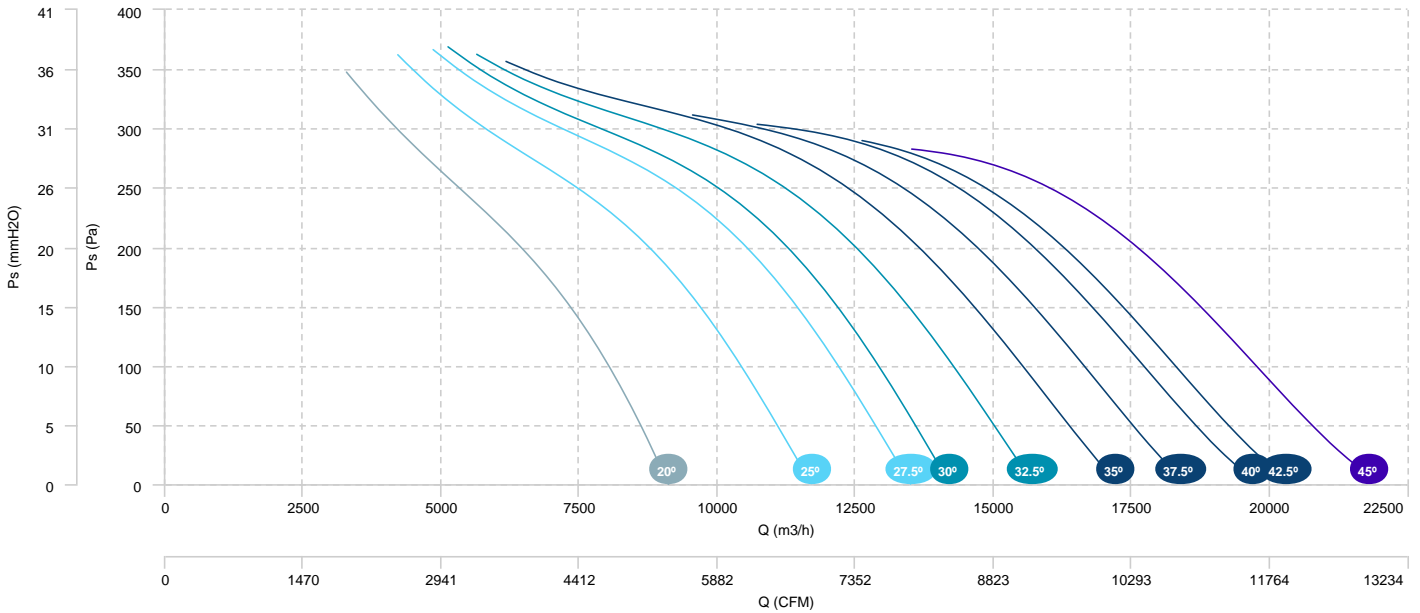

## AIR FLOW - ABSORBED POWER (4 poles)

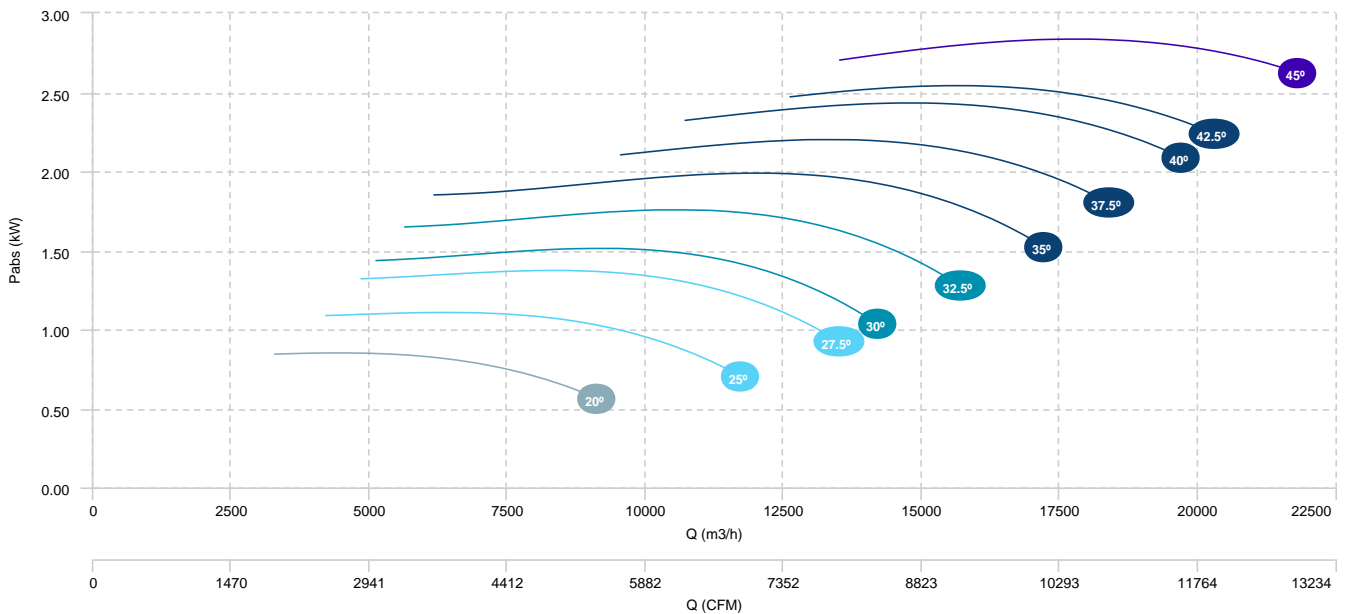

HM 63 T4/T8 0,75/0,12kW (A2:9)	HM 63 T4/T8 1,1/0,18kW (A2:9)	HM 63 T4/T8 1,5/0,25kW (A2:9)
HM 63 T4/T8 2,2/0,37kW (A2:9)	HM 63 T4/T8 3/0,55kW (A2:9)	

## AIR FLOW - PRESSURE (8 poles)

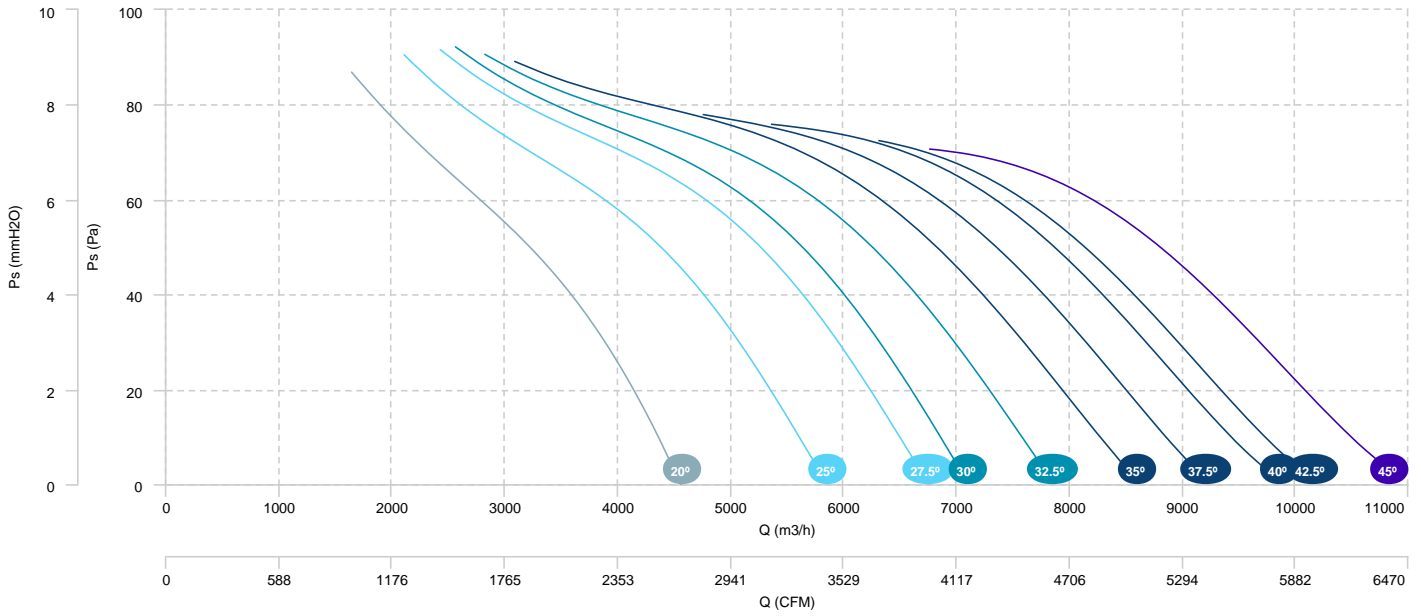

HM 63 T4/T8 0,55/0,09kW (A2:6)	HM 63 T4/T8 0,75/0,12kW (A2:6)	HM 63 T4/T8 1,1/0,18kW (A2:6)
HM 63 T4/T8 1,5/0,25kW (A2:6)	HM 63 T4/T8 2,2/0,37kW (A2:6)	

## AIR FLOW - PRESSURE (4 poles)

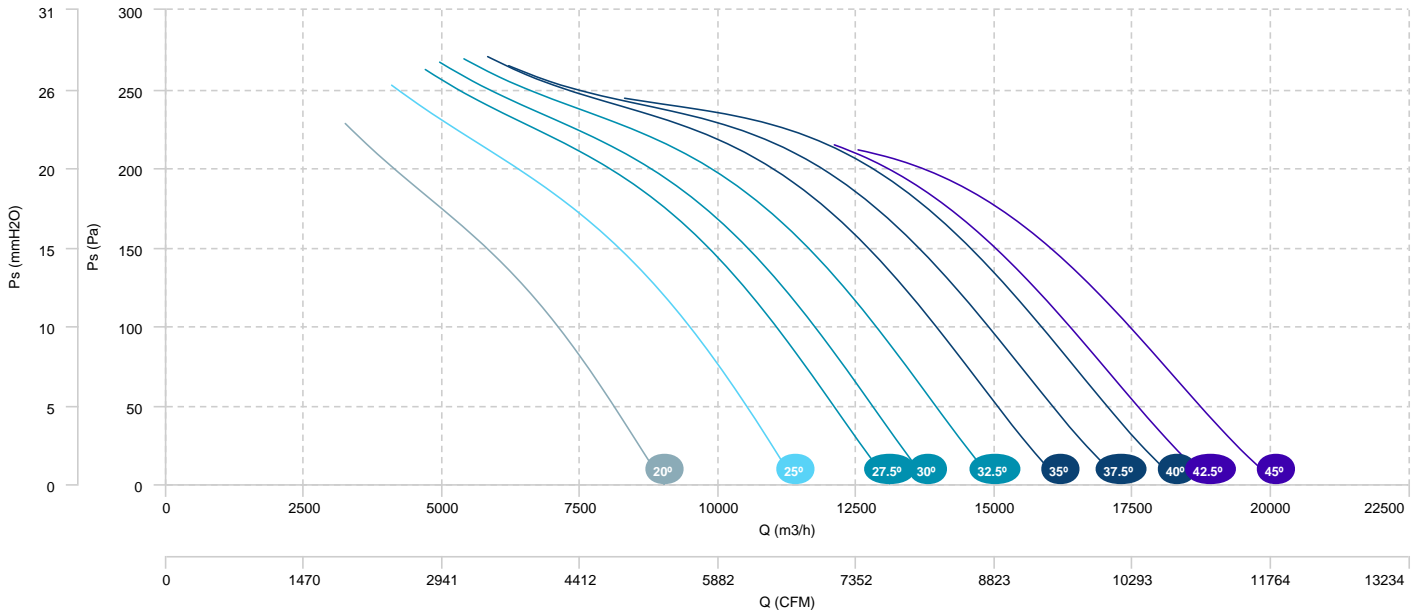

## AIR FLOW - ABSORBED POWER (4 poles)

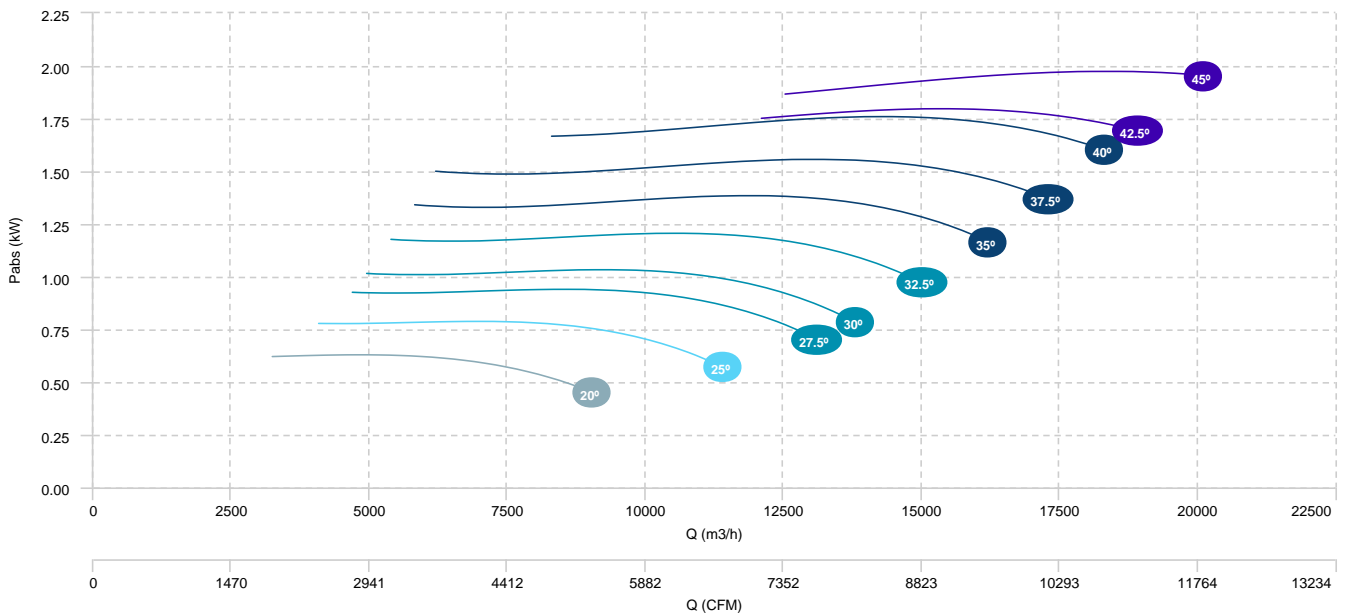

HM 63 T4/T8 0,55/0,09kW (A2:6)	HM 63 T4/T8 0,75/0,12kW (A2:6)	HM 63 T4/T8 1,1/0,18kW (A2:6)
HM 63 T4/T8 1,5/0,25kW (A2:6)	HM 63 T4/T8 2,2/0,37kW (A2:6)	

## AIR FLOW - PRESSURE (8 poles)

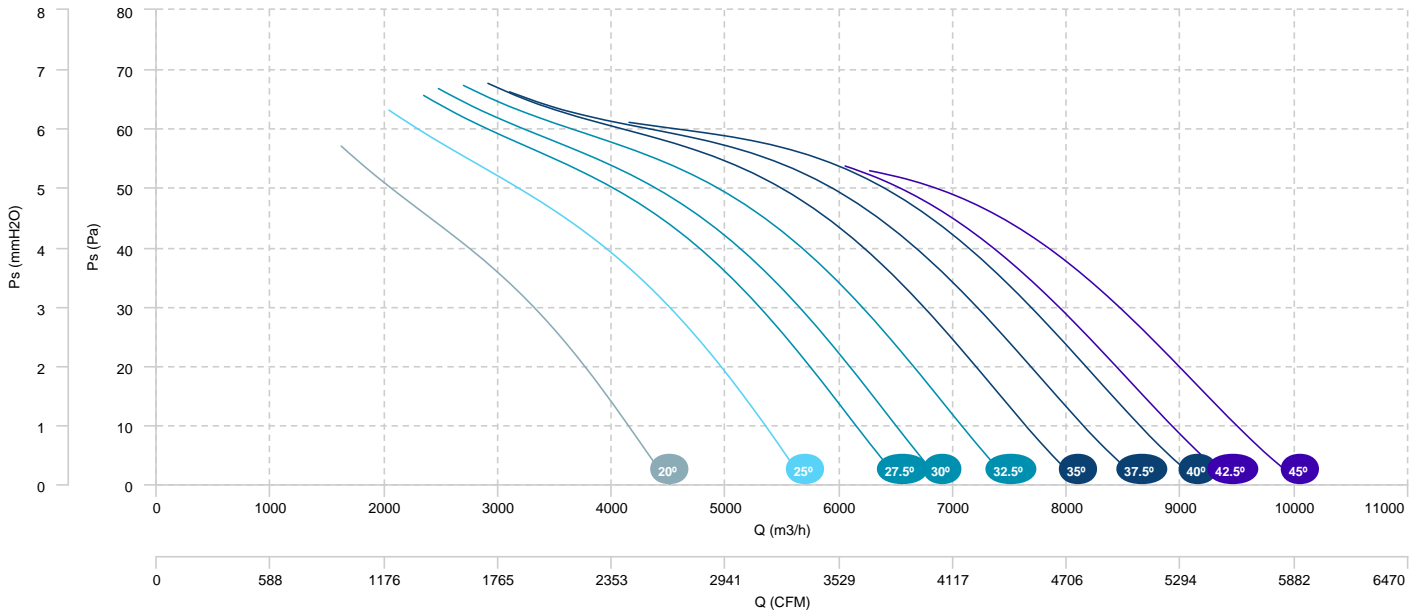

HM 71 T4 1,1kW (A2:9)	HM 71 T4 1,5kW (A2:9)	HM 71 T4 2,2kW (A2:9)
HM 71 T4 3kW (A2:9)		

## AIR FLOW - PRESSURE

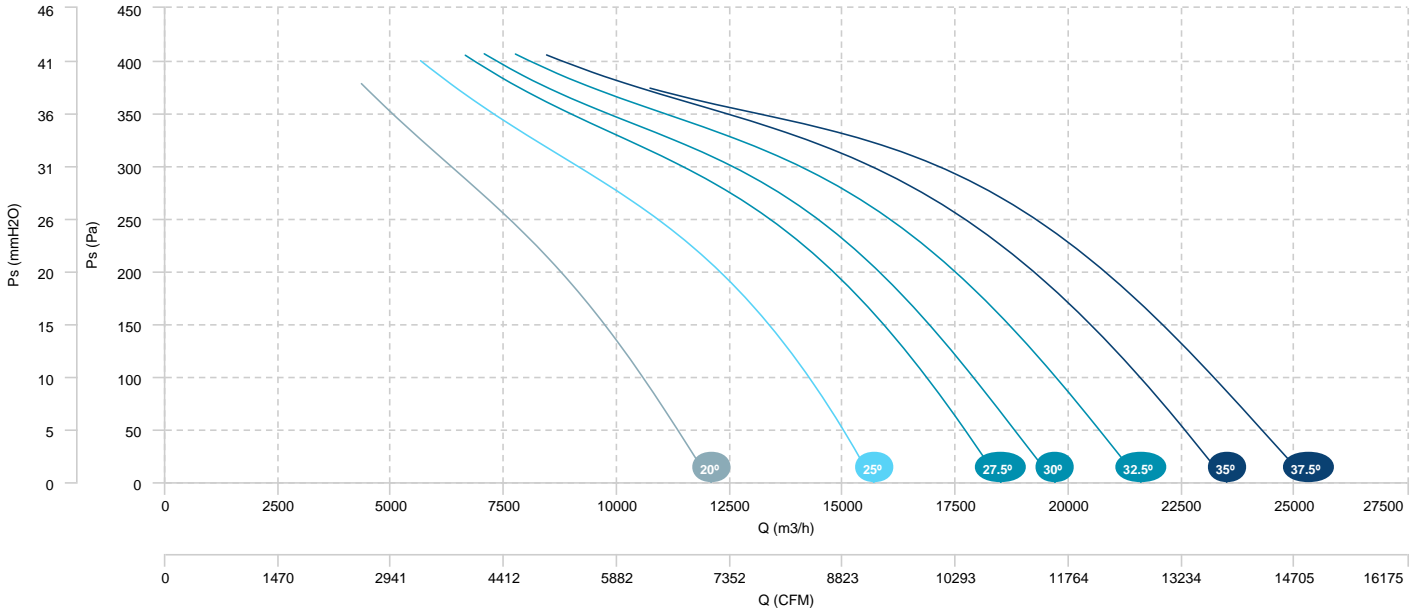

## AIR FLOW - ABSORBED POWER

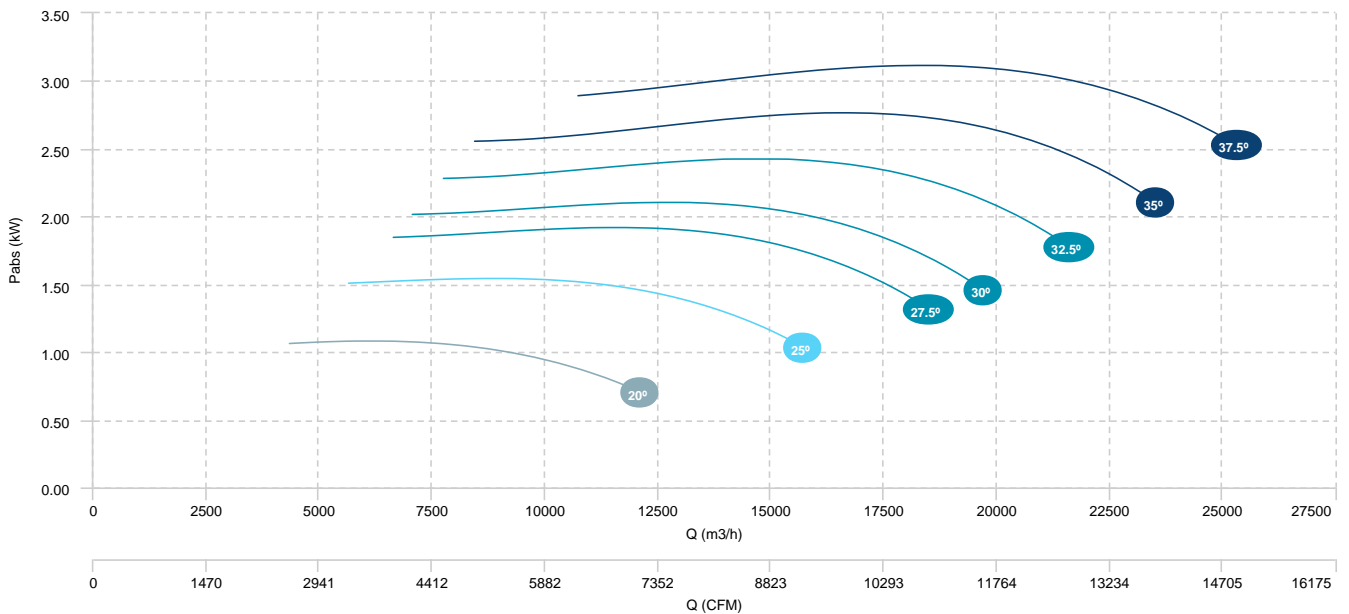



HM 71 T4 0,75kW (A5:6)	HM 71 T4 1,1kW (A5:6)	HM 71 T4 1,5kW (A5:6)
HM 71 T4 2,2kW (A5:6)	HM 71 T4 3kW (A5:6)	

## AIR FLOW - PRESSURE

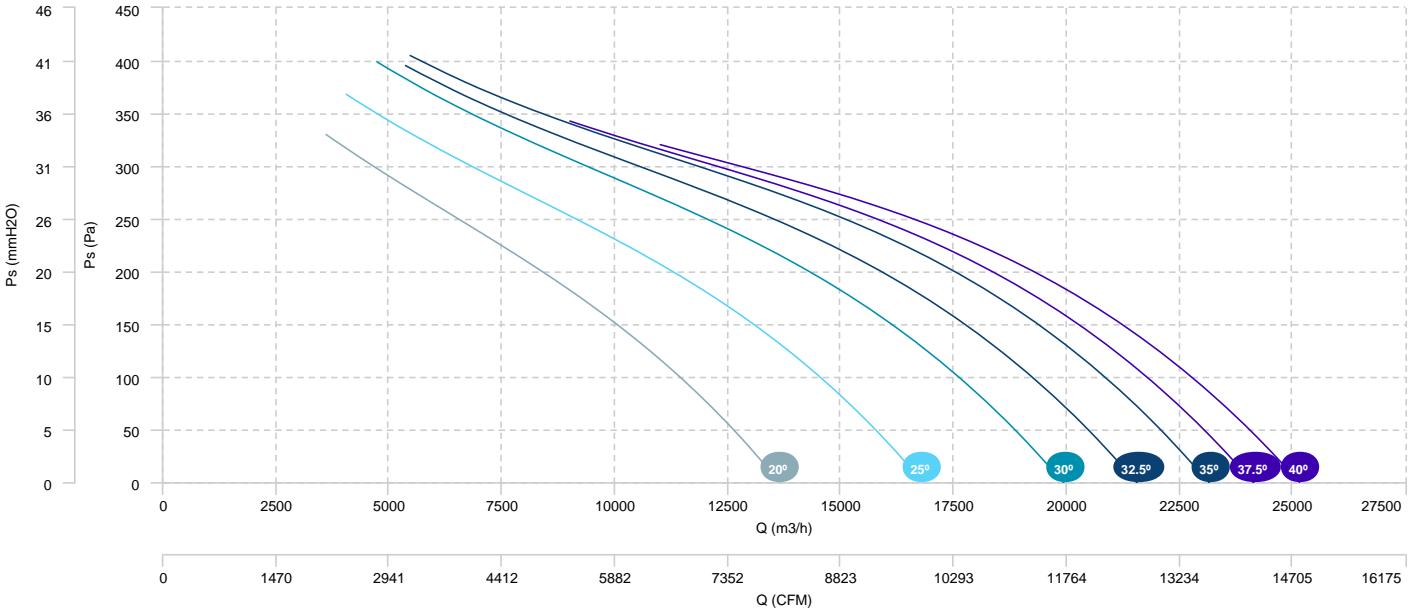

## AIR FLOW - ABSORBED POWER

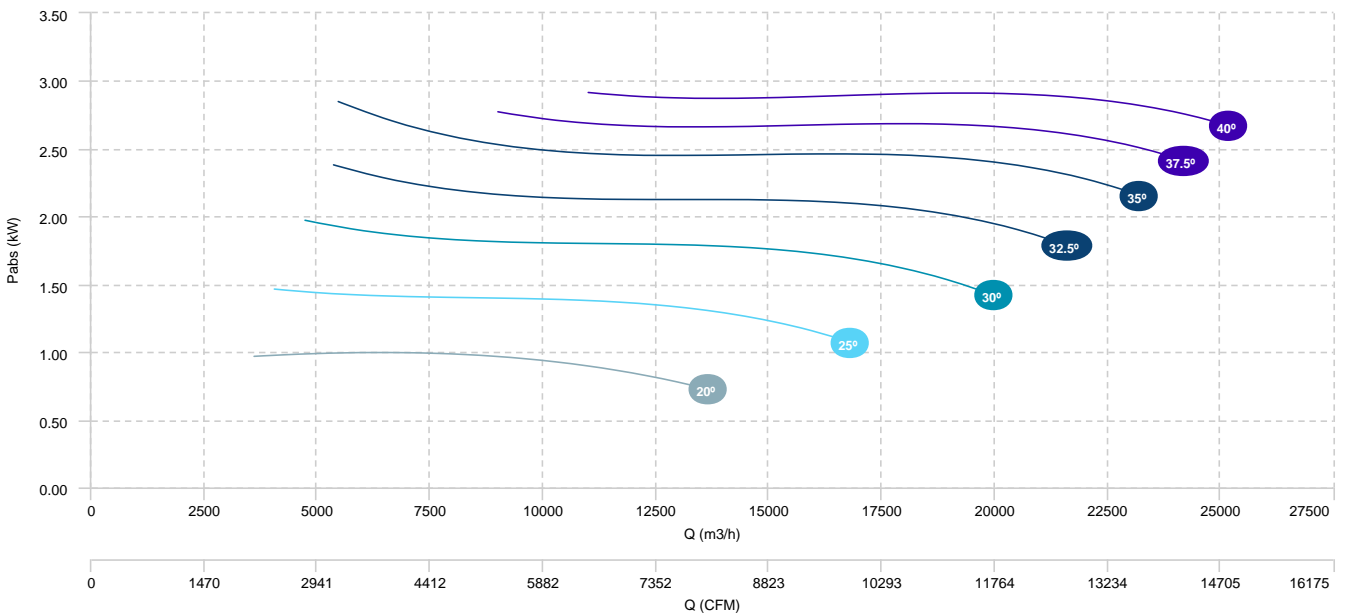

HM 71 T4 0,75kW (A2:6)	HM 71 T4 1,1kW (A2:6)	HM 71 T4 1,5kW (A2:6)
HM 71 T4 2,2kW (A2:6)	HM 71 T4 3kW (A2:6)	

## AIR FLOW - PRESSURE

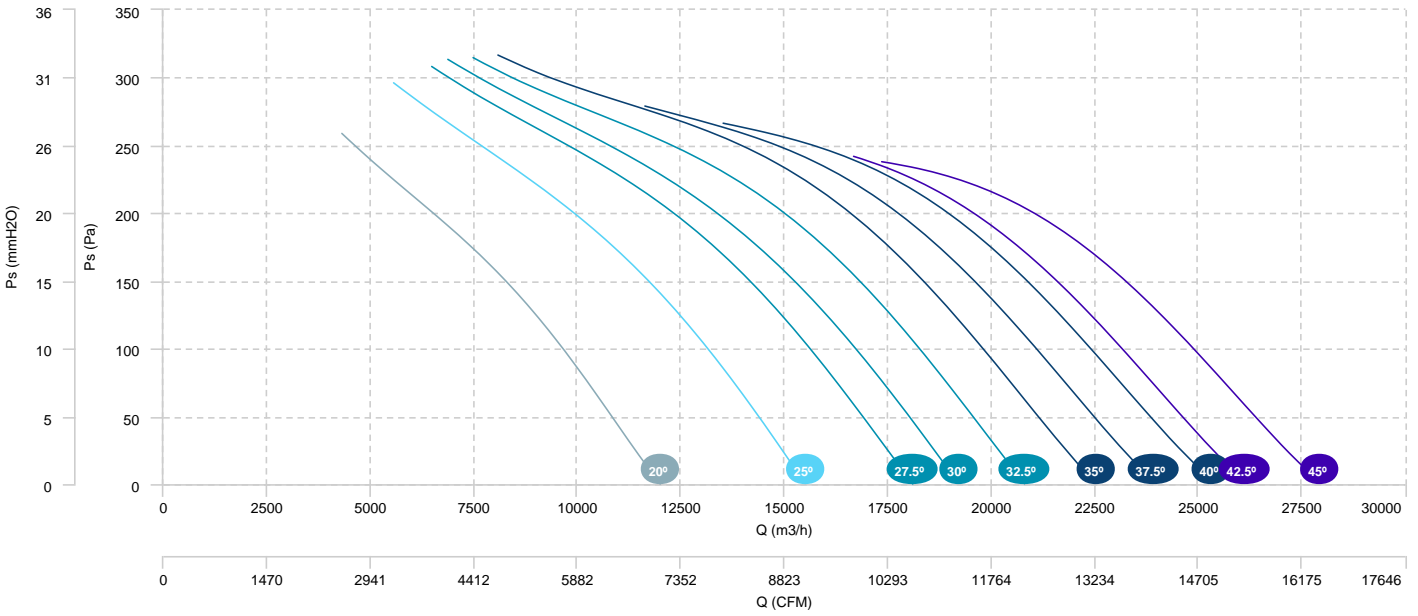

## AIR FLOW - ABSORBED POWER

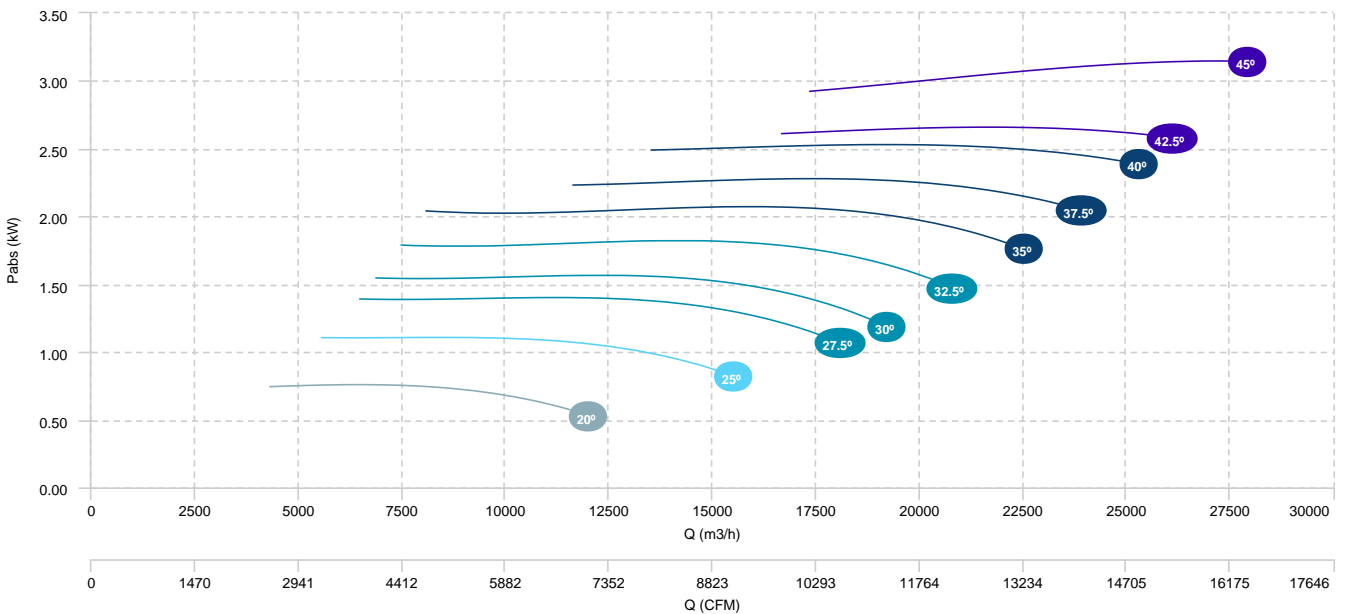

HM 71 T6 0,55kW (A2:6)

HM 71 T6 0,75kW (A2:6)

AIR FLOW - PRESSURE

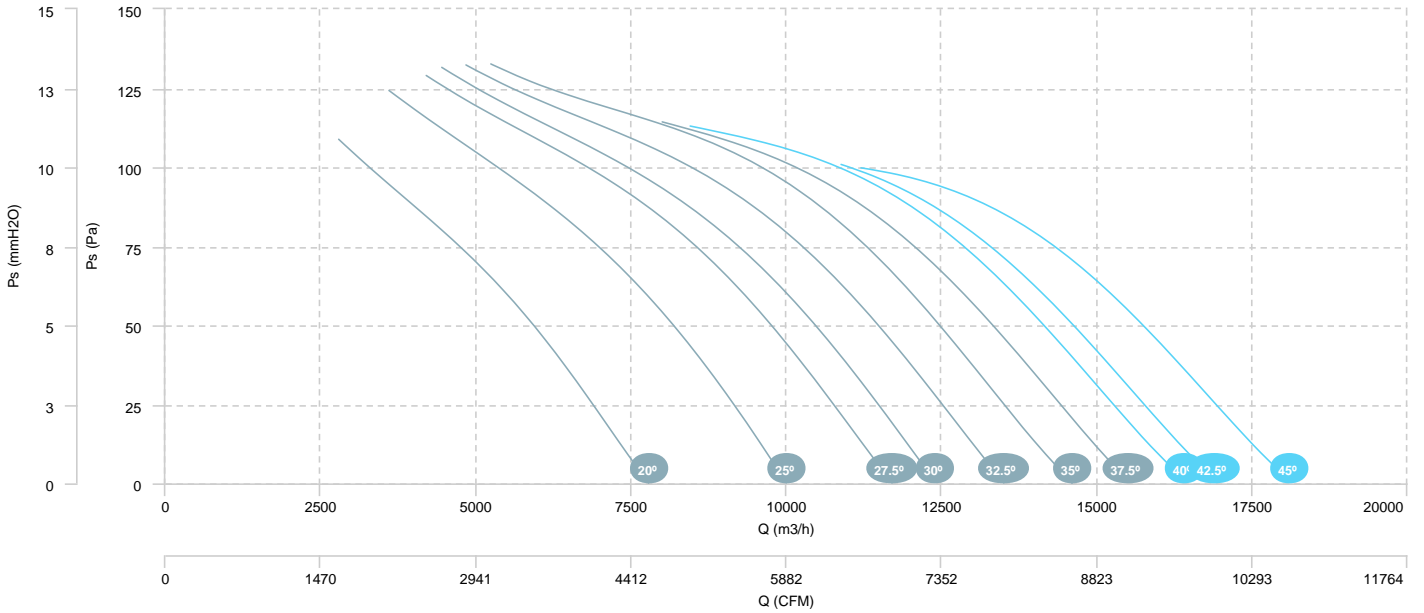

AIR FLOW - ABSORBED POWER

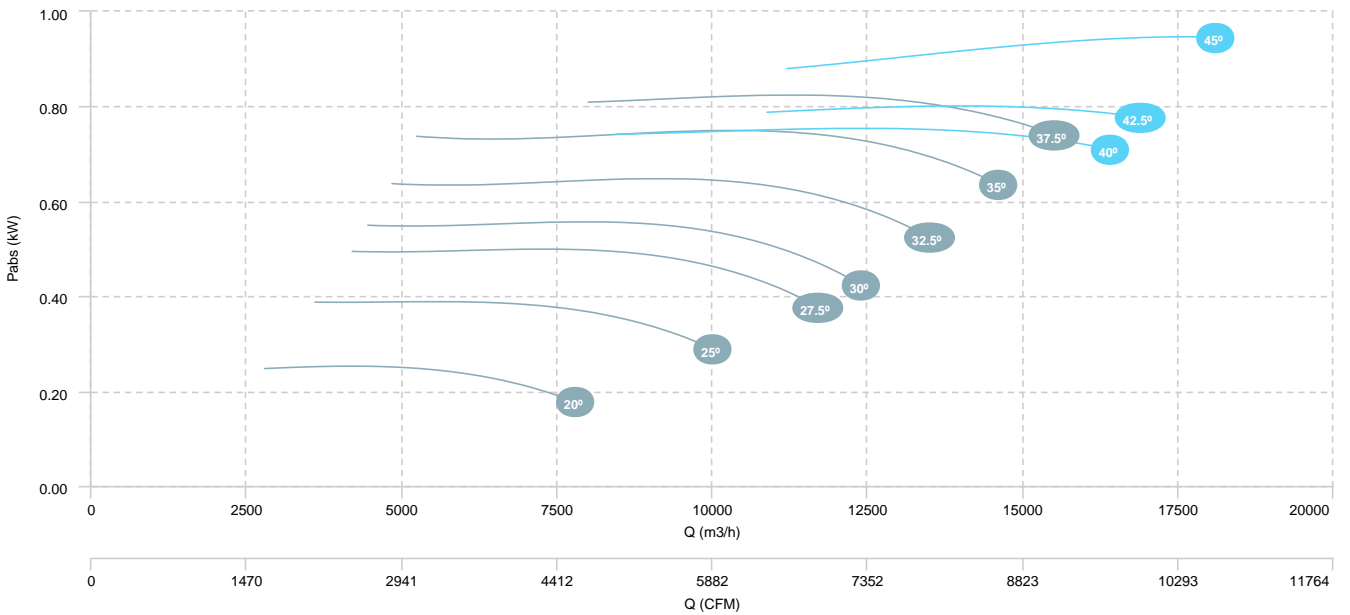

HM 71 T6 0,75kW (A5:6)

AIR FLOW - PRESSURE

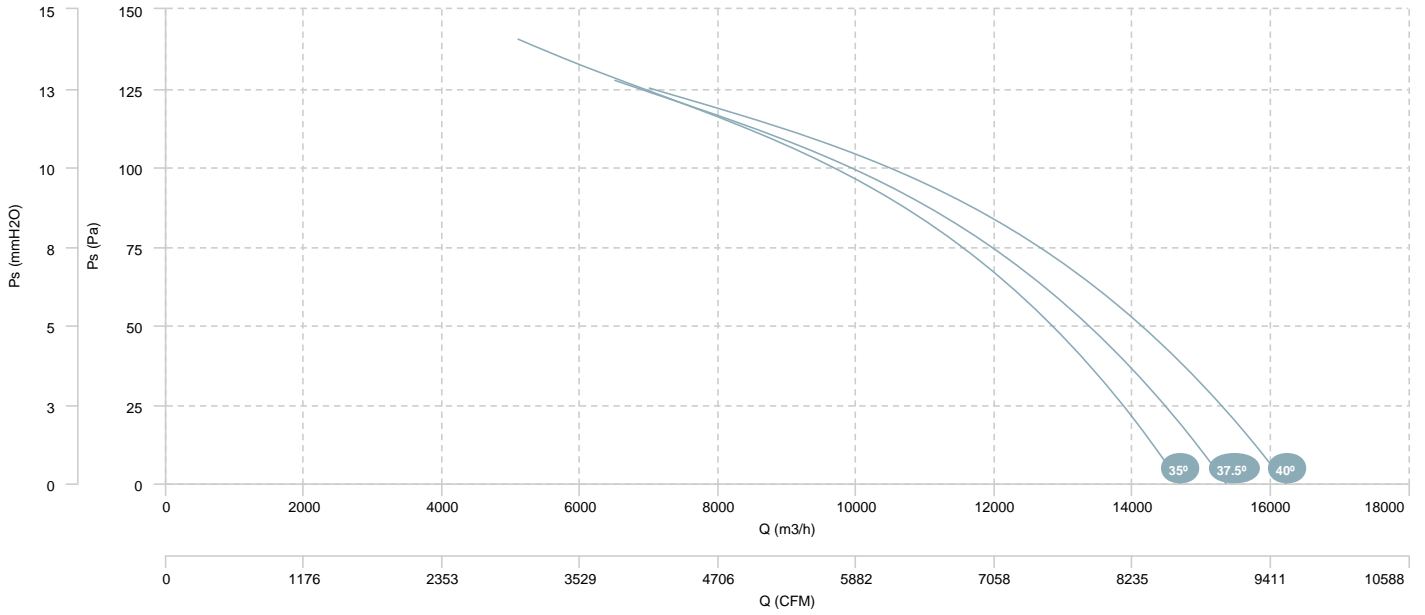

AIR FLOW - ABSORBED POWER

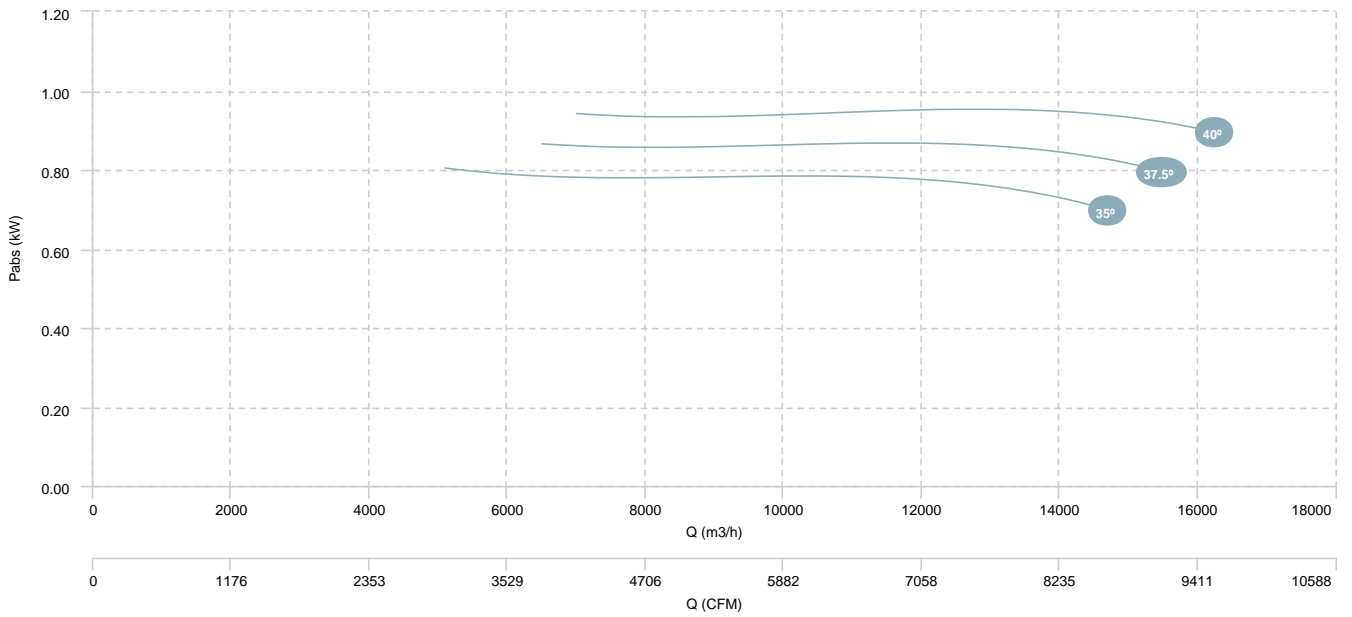

HM 71 T6 0,55kW (A2:9)

HM 71 T6 0,75kW (A2:9)

HM 71 T6 1,1kW (A2:9)

AIR FLOW - PRESSURE

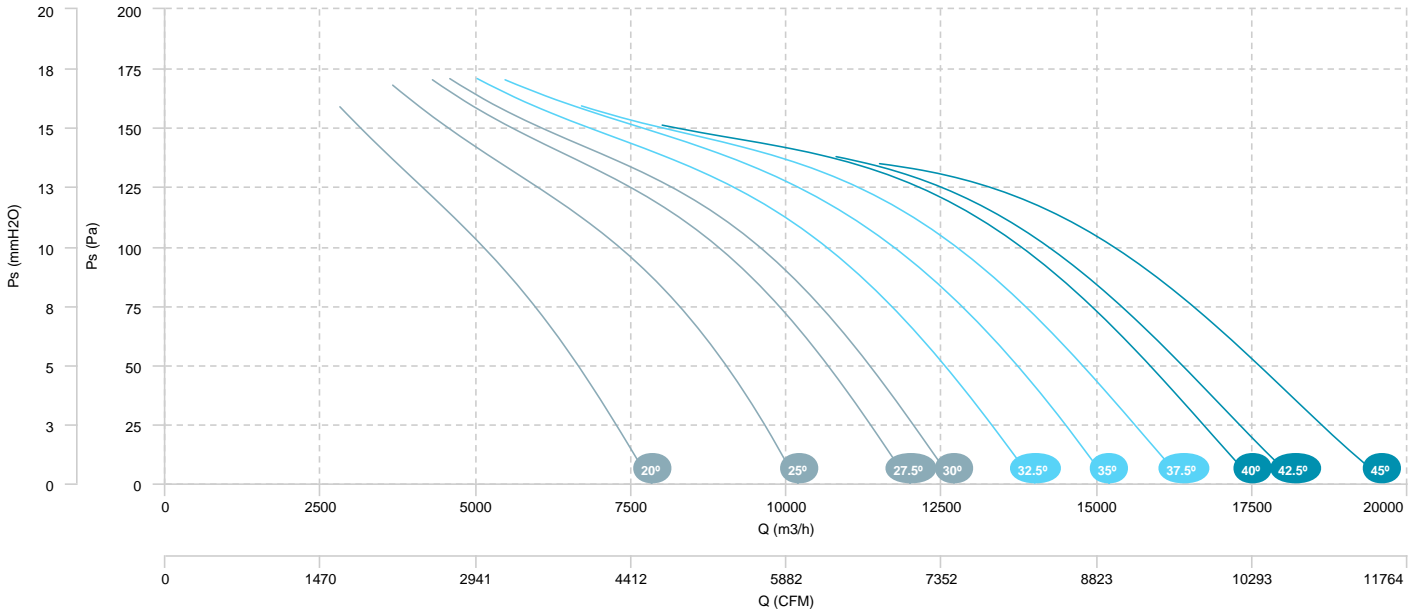

AIR FLOW - ABSORBED POWER

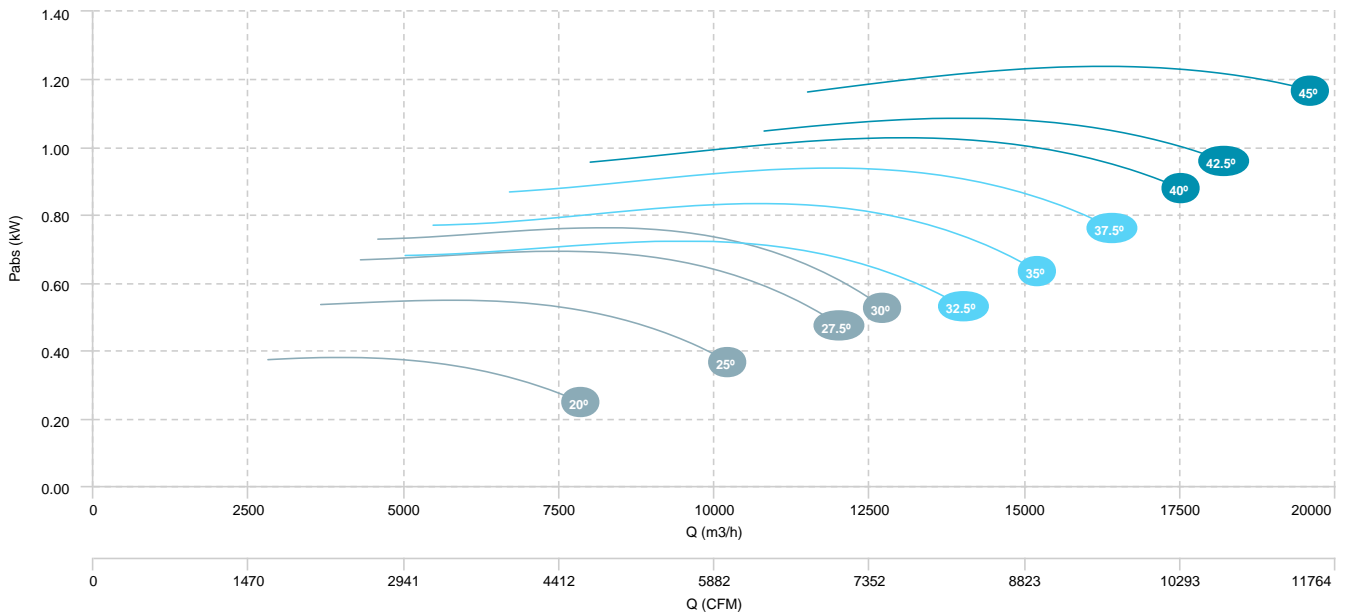

HM 71 T4/T6 1,1/0,37kW (A2:9)

HM 71 T4/T6 1,5/0,5kW (A2:9)

HM 71 T4/T6 2,2/0,6kW (A2:9)

HM 71 T4/T6 3/0,9kW (A2:9)

## AIR FLOW - PRESSURE (4 poles)

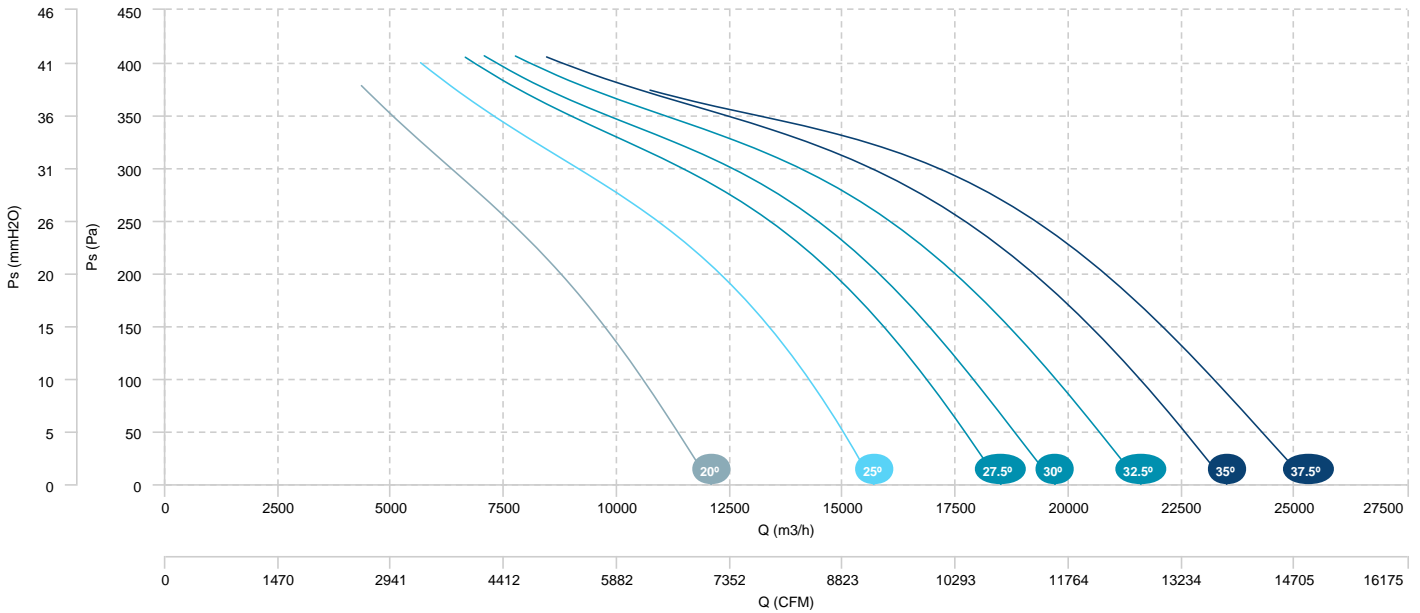

## AIR FLOW - ABSORBED POWER (4 poles)

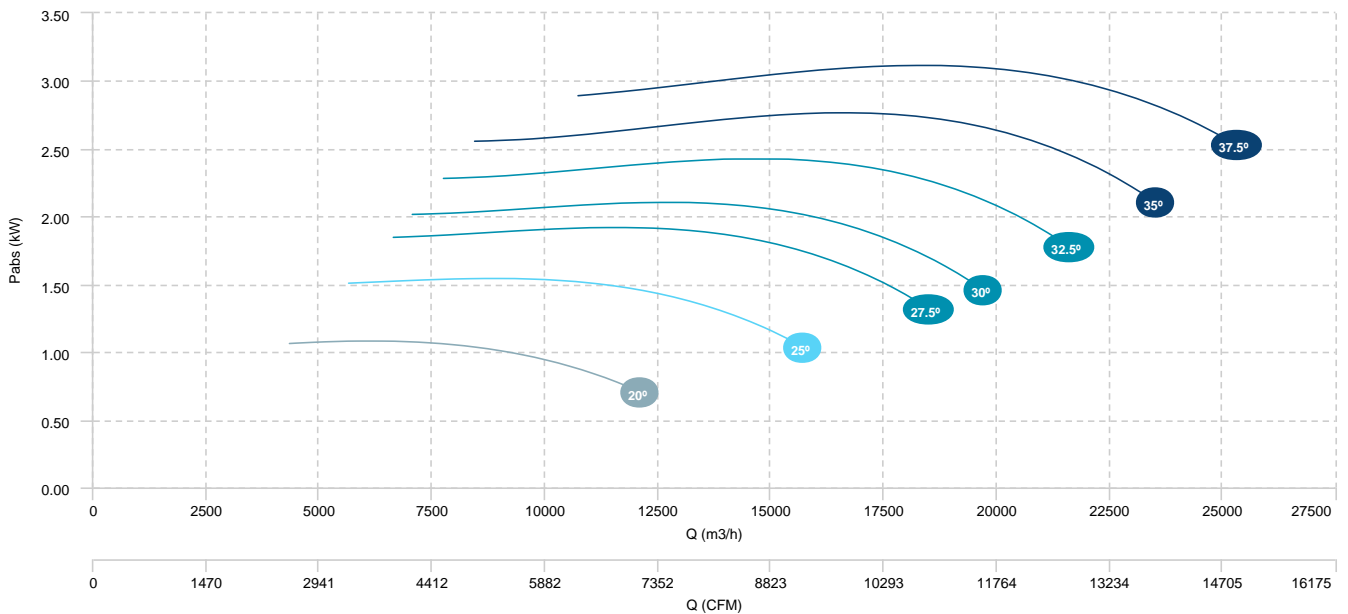

HM 71 T4/T6 1,1/0,37kW (A2:9)	HM 71 T4/T6 1,5/0,5kW (A2:9)	HM 71 T4/T6 2,2/0,6kW (A2:9)
HM 71 T4/T6 3/0,9kW (A2:9)		

## AIR FLOW - PRESSURE (6 poles)

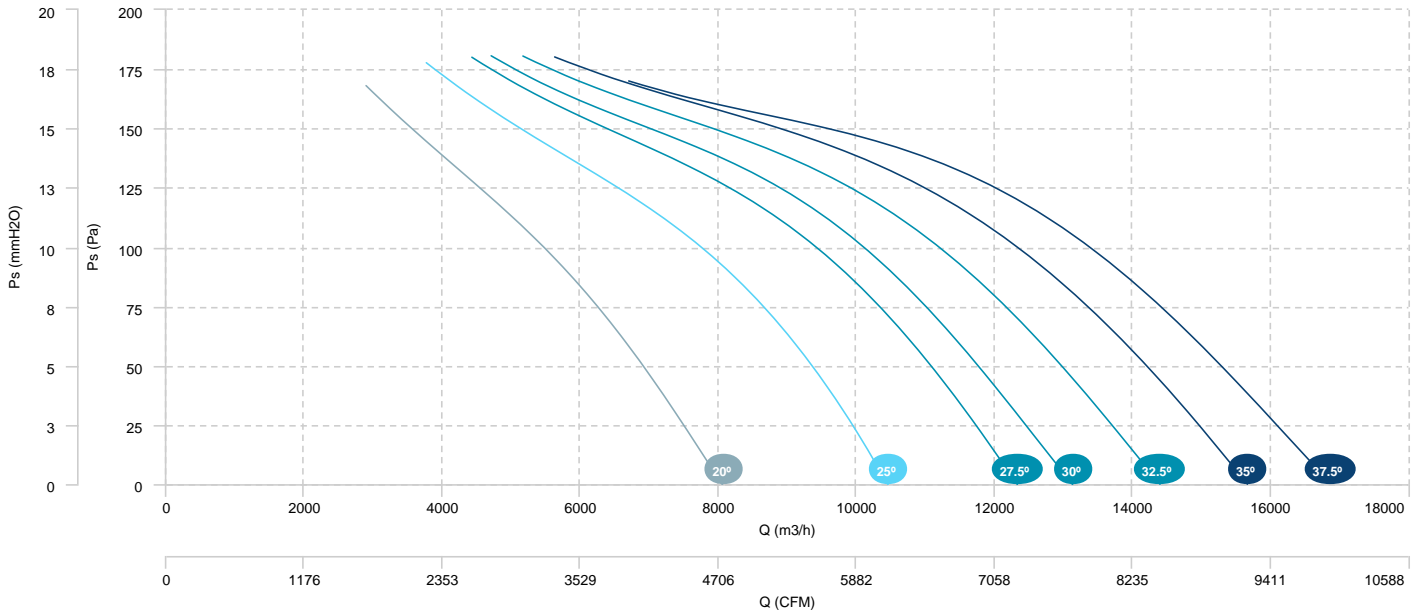

HM 71 T4/T6 0,75/0,25kW (A2:6)	HM 71 T4/T6 1,1/0,37kW (A2:6)	HM 71 T4/T6 1,5/0,5kW (A2:6)
HM 71 T4/T6 2,2/0,6kW (A2:6)	HM 71 T4/T6 3/0,9kW (A2:6)	

## AIR FLOW - PRESSURE (4 poles)

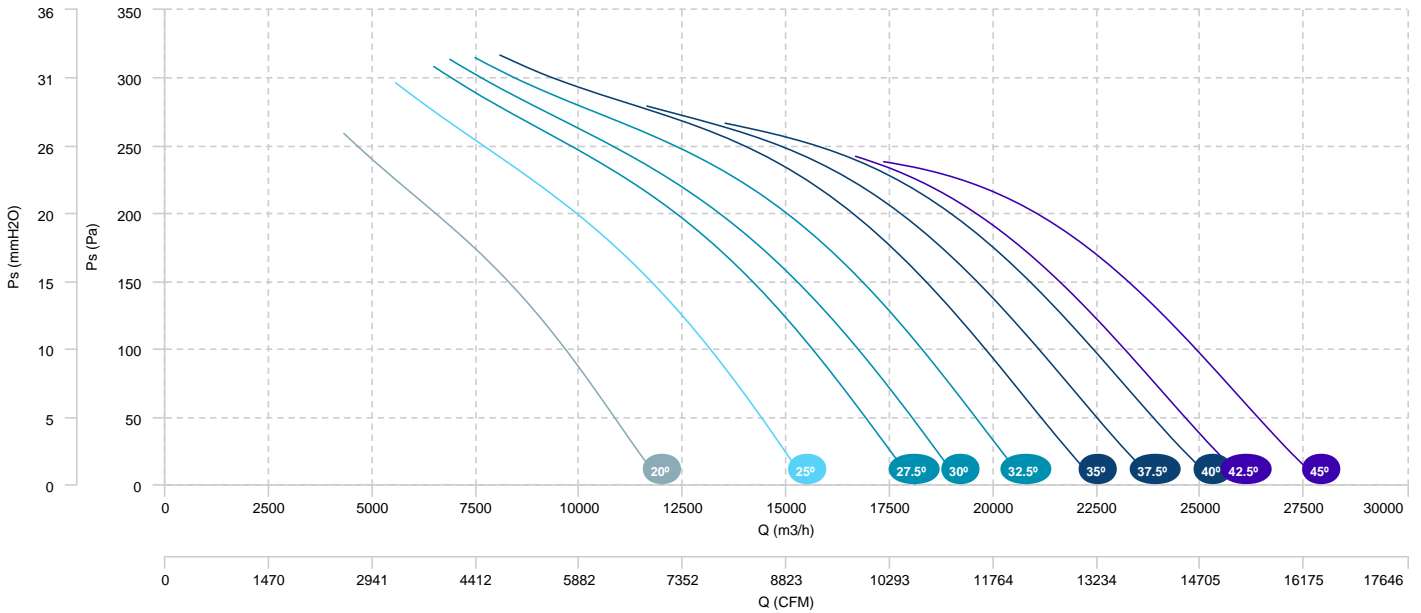

## AIR FLOW - ABSORBED POWER (4 poles)

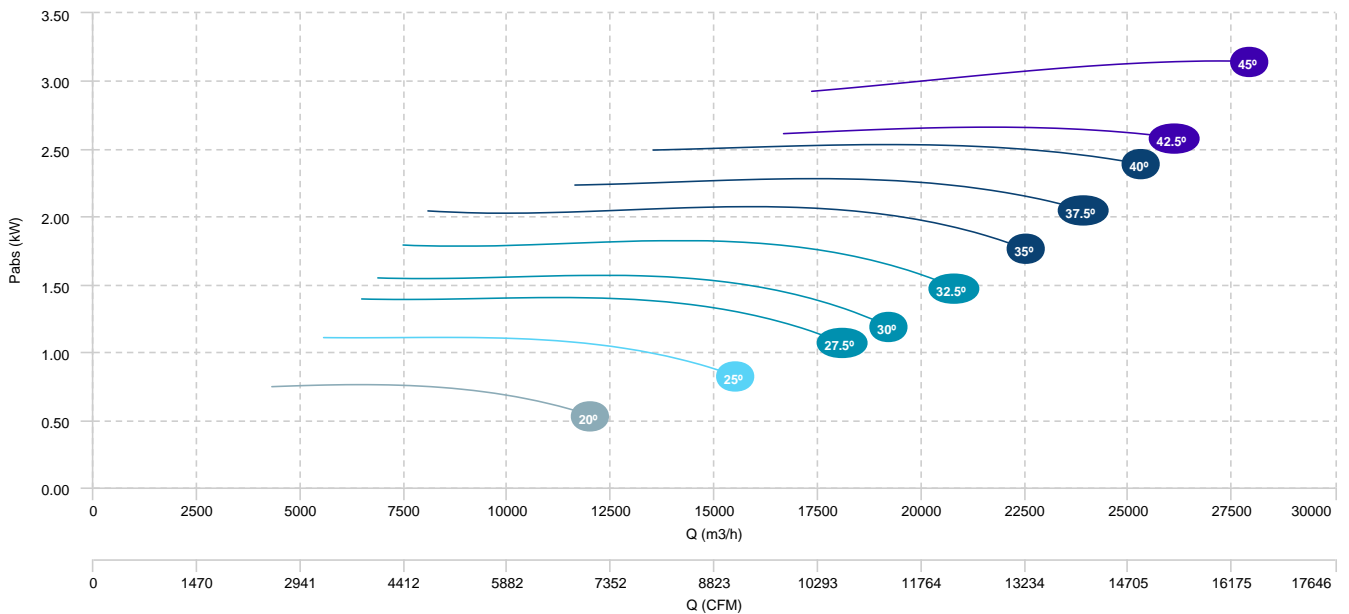



HM 71 T4/T6 0,75/0,25kW (A2:6)	HM 71 T4/T6 1,1/0,37kW (A2:6)	HM 71 T4/T6 1,5/0,5kW (A2:6)
HM 71 T4/T6 2,2/0,6kW (A2:6)	HM 71 T4/T6 3/0,9kW (A2:6)	

AIR FLOW - PRESSURE (6 poles)

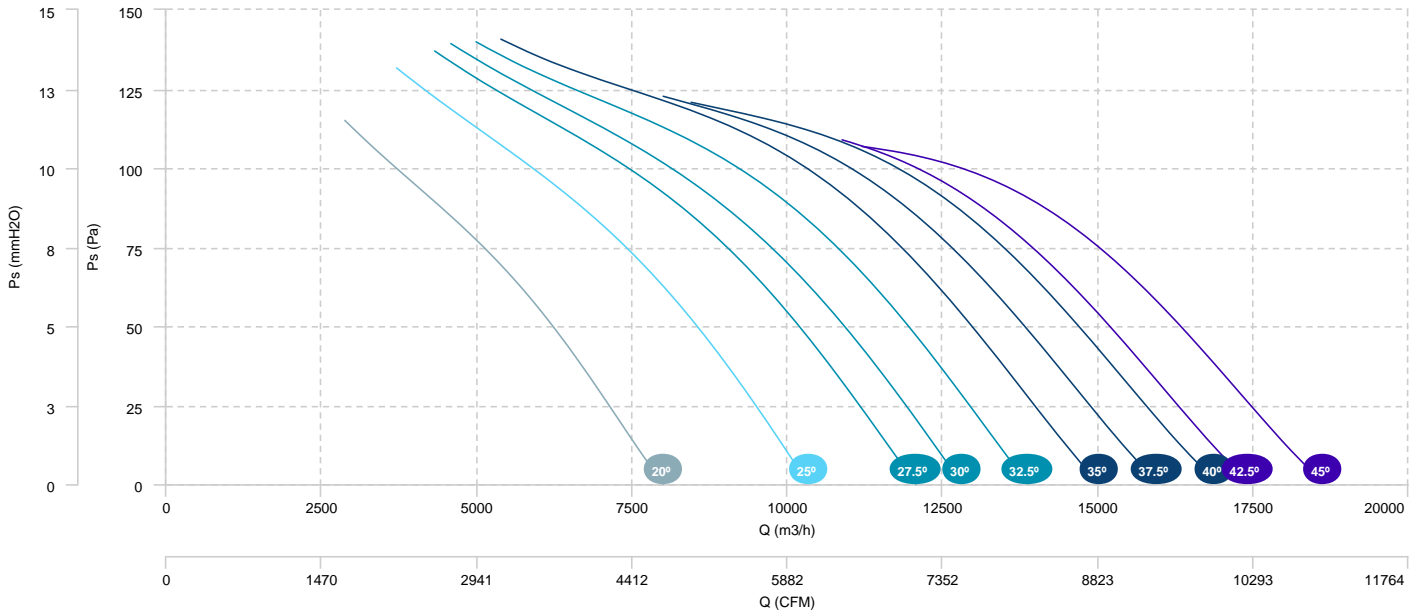

HM 71 T4/T6 0,75/0,25kW (A5:6)	HM 71 T4/T6 1,1/0,37kW (A5:6)	HM 71 T4/T6 1,5/0,5kW (A5:6)
HM 71 T4/T6 2,2/0,6kW (A5:6)	HM 71 T4/T6 3/0,9kW (A5:6)	

## AIR FLOW - PRESSURE (4 poles)

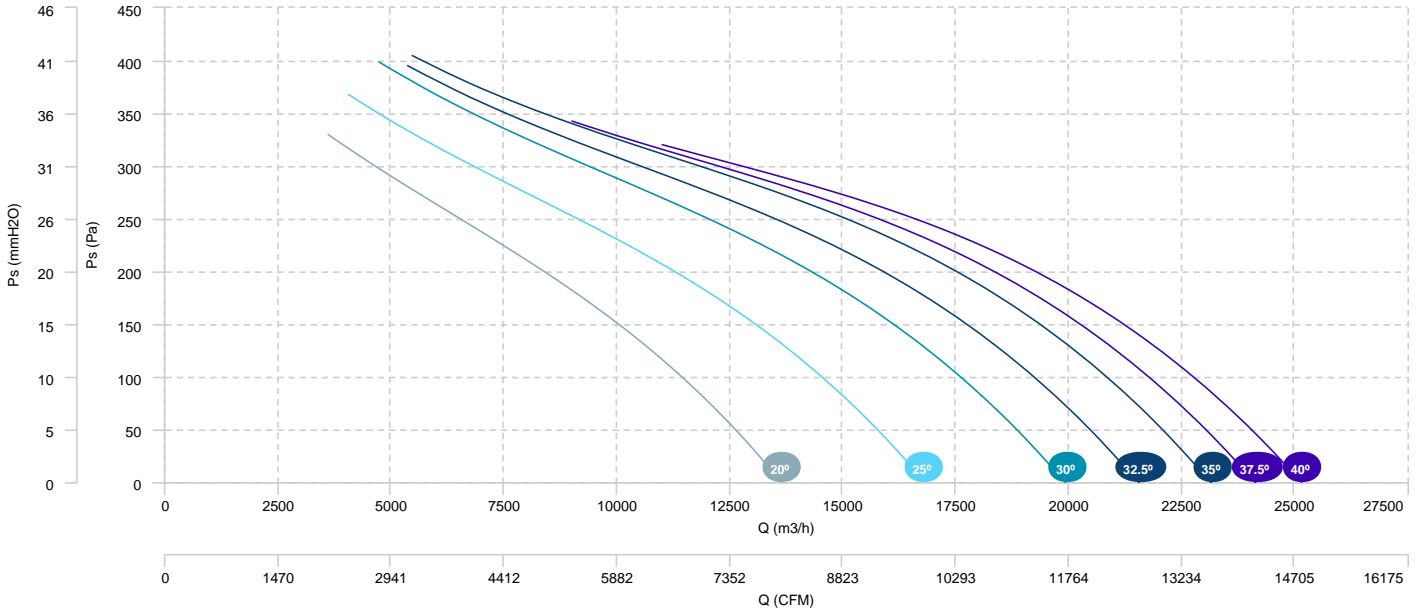

## AIR FLOW - ABSORBED POWER (4 poles)

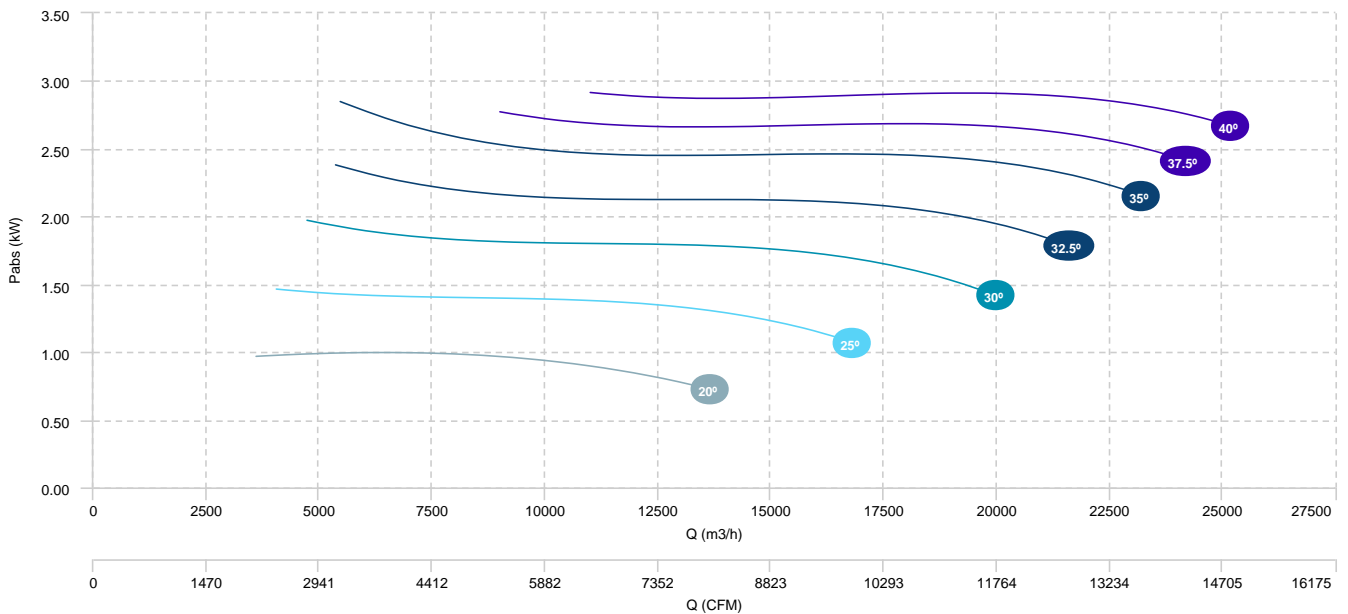

HM 71 T4/T6 0,75/0,25kW (A5:6)	HM 71 T4/T6 1,1/0,37kW (A5:6)	HM 71 T4/T6 1,5/0,5kW (A5:6)
HM 71 T4/T6 2,2/0,6kW (A5:6)	HM 71 T4/T6 3/0,9kW (A5:6)	

## AIR FLOW - PRESSURE (6 poles)

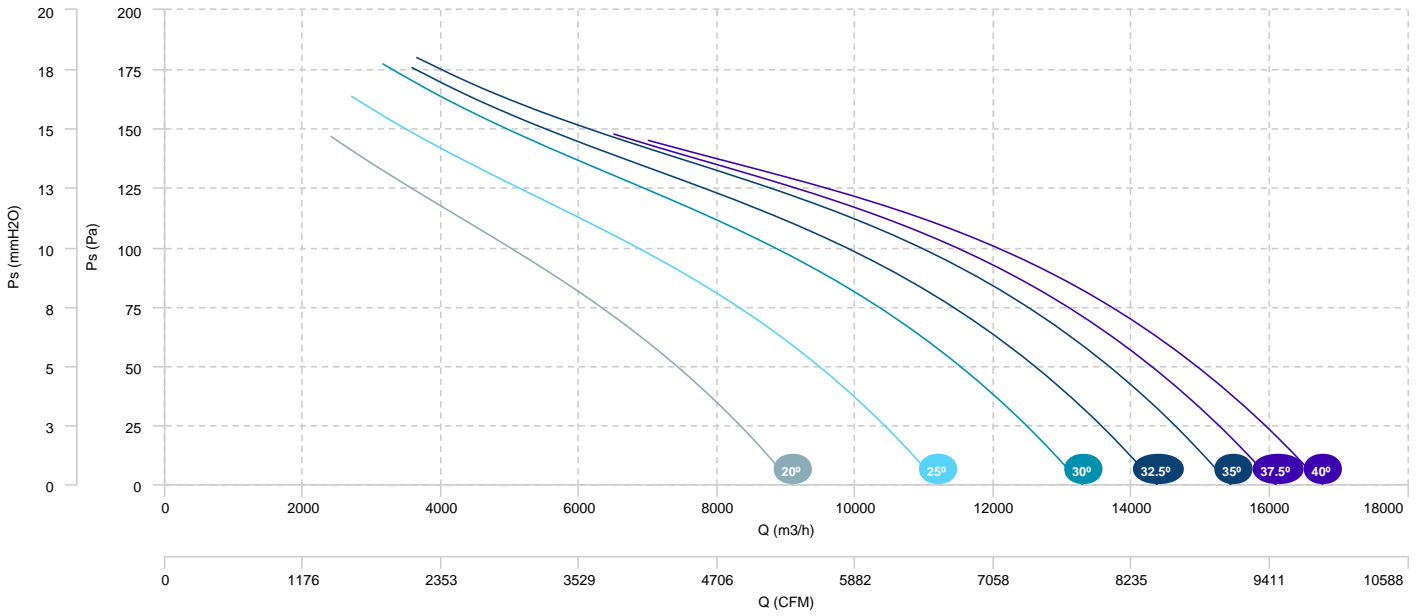

HM 71 T4/T8 1,1/0,18kW (A2:9)	HM 71 T4/T8 1,5/0,25kW (A2:9)	HM 71 T4/T8 2,2/0,37kW (A2:9)
HM 71 T4/T8 3/0,55kW (A2:9)		

## AIR FLOW - PRESSURE (4 poles)

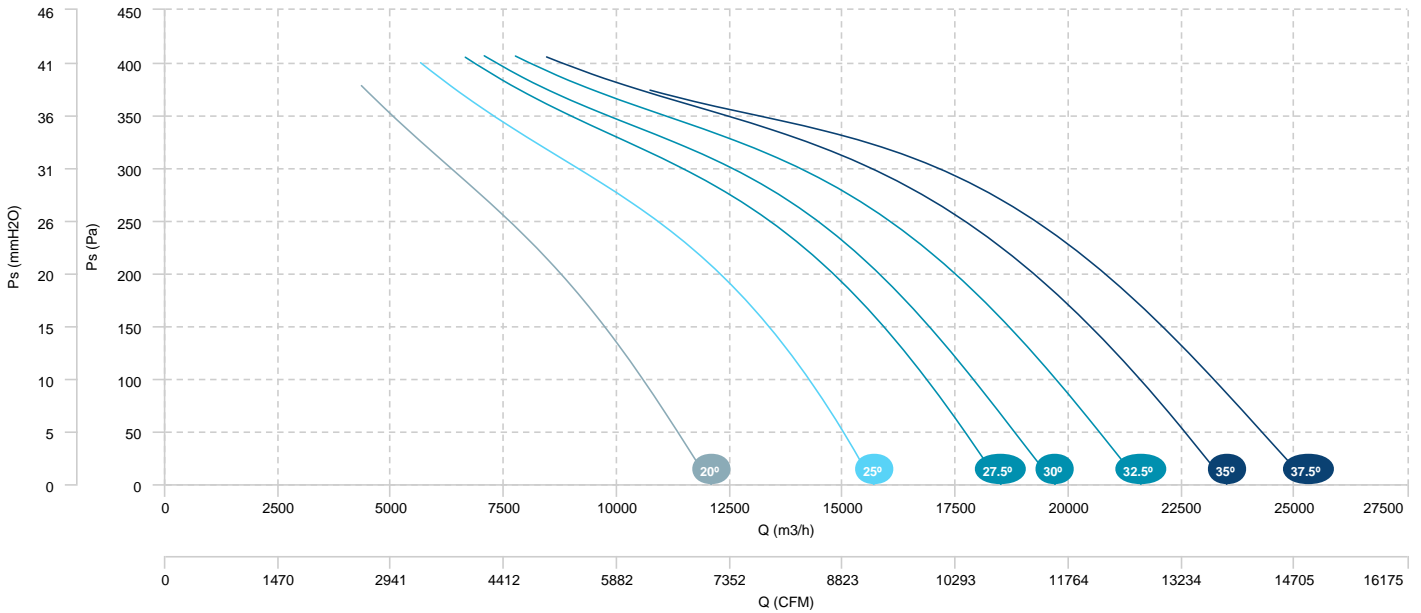

## AIR FLOW - ABSORBED POWER (4 poles)

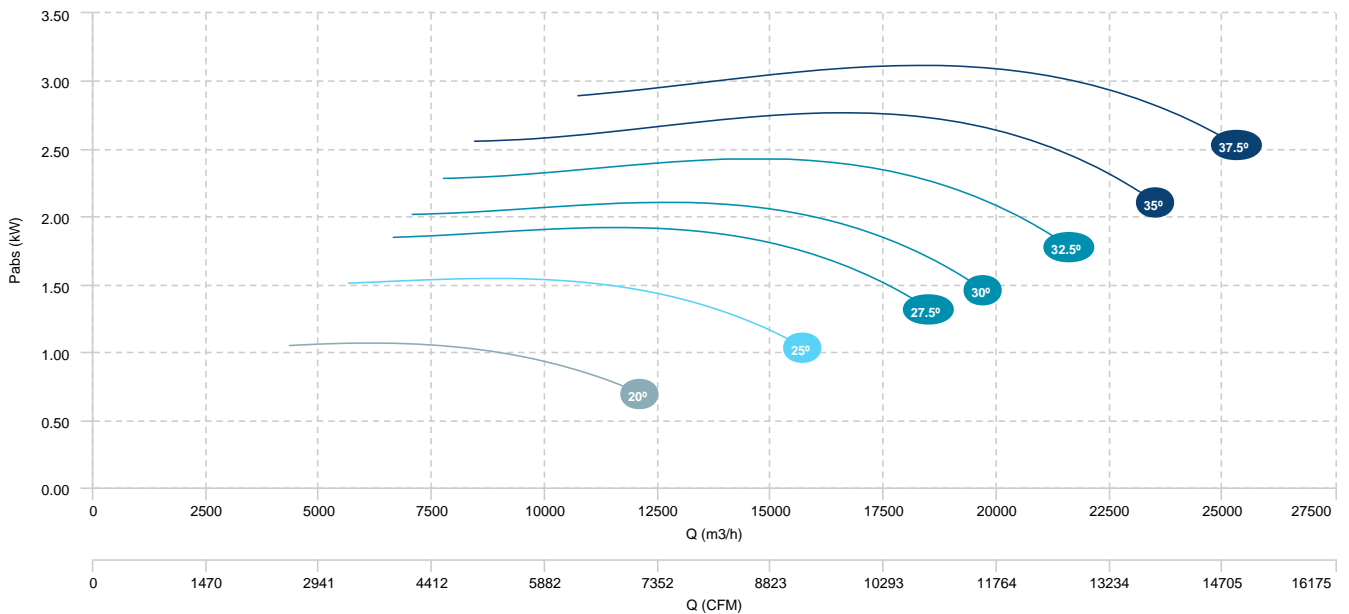

HM 71 T4/T8 1,1/0,18kW (A2:9)  
 HM 71 T4/T8 3/0,55kW (A2:9)

HM 71 T4/T8 1,5/0,25kW (A2:9)

HM 71 T4/T8 2,2/0,37kW (A2:9)

AIR FLOW - PRESSURE (8 poles)

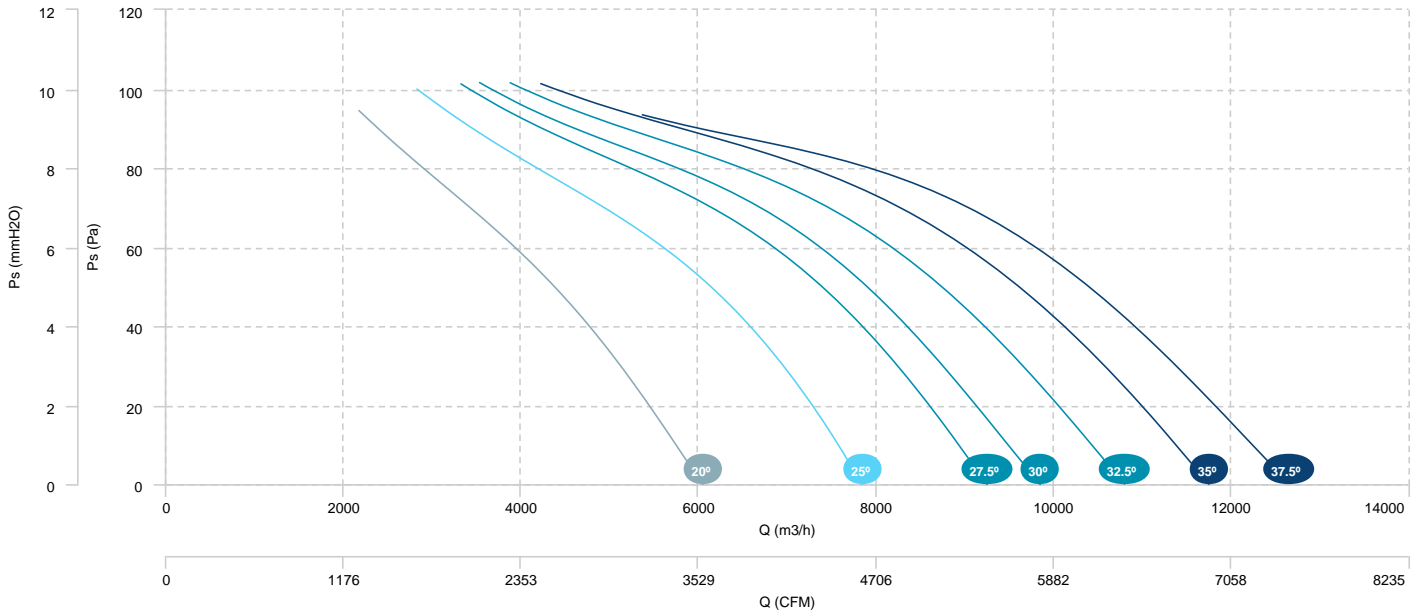

HM 71 T4/T8 0,75/0,12kW (A2:6)	HM 71 T4/T8 1,1/0,18kW (A2:6)	HM 71 T4/T8 1,5/0,25kW (A2:6)
HM 71 T4/T8 2,2/0,37kW (A2:6)	HM 71 T4/T8 3/0,55kW (A2:6)	

## AIR FLOW - PRESSURE (4 poles)

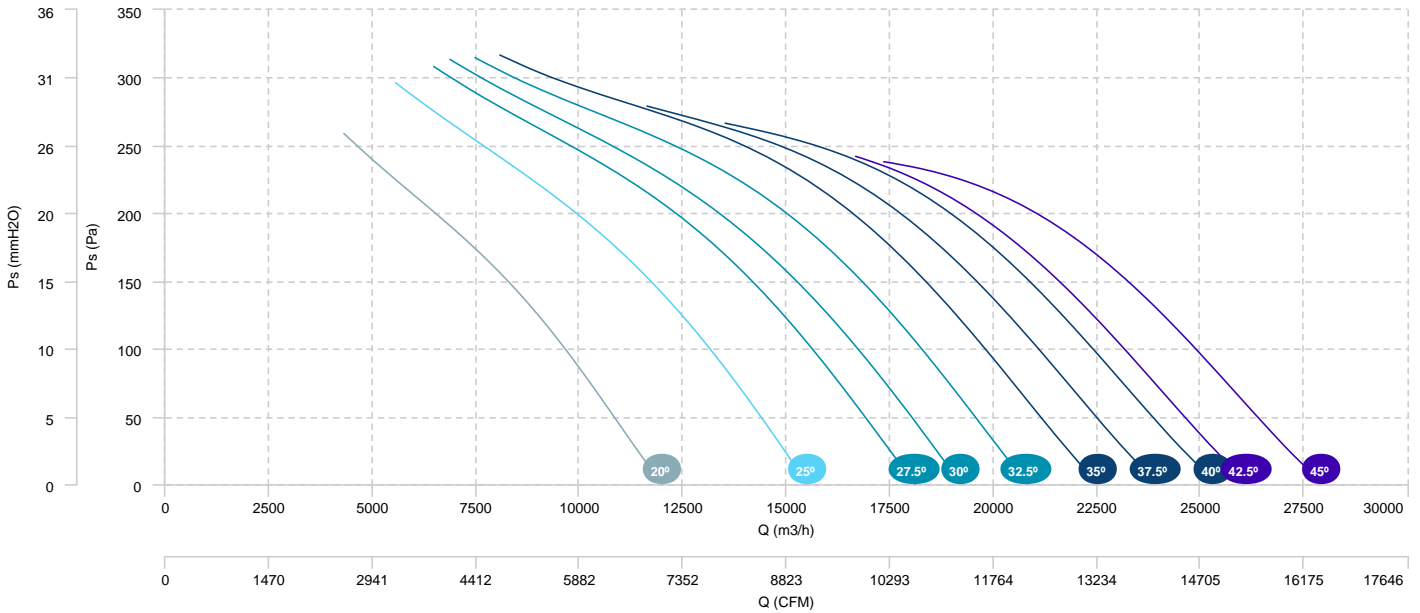

## AIR FLOW - ABSORBED POWER (4 poles)



HM 71 T4/T8 0,75/0,12kW (A2:6)	HM 71 T4/T8 1,1/0,18kW (A2:6)	HM 71 T4/T8 1,5/0,25kW (A2:6)
HM 71 T4/T8 2,2/0,37kW (A2:6)	HM 71 T4/T8 3/0,55kW (A2:6)	

## AIR FLOW - PRESSURE (8 poles)

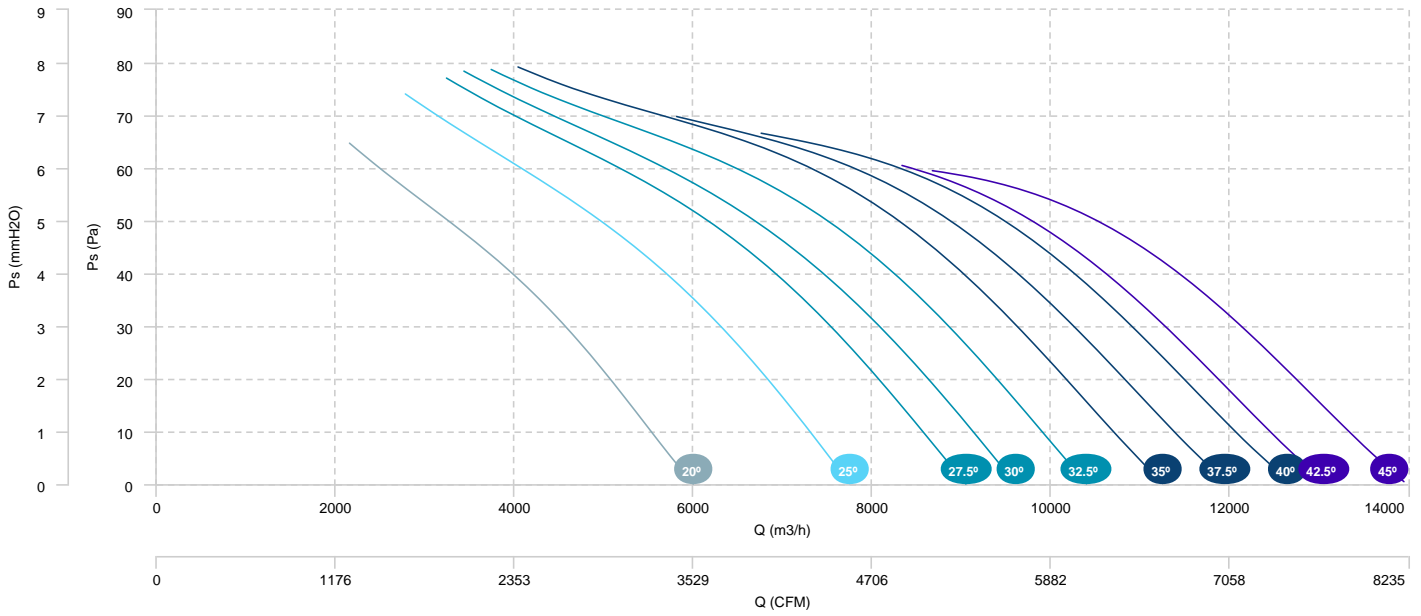

HM 71 T4/T8 0,75/0,12kW (A5:6)	HM 71 T4/T8 1,1/0,18kW (A5:6)	HM 71 T4/T8 1,5/0,25kW (A5:6)
HM 71 T4/T8 2,2/0,37kW (A5:6)	HM 71 T4/T8 3/0,55kW (A5:6)	

## AIR FLOW - PRESSURE (4 poles)

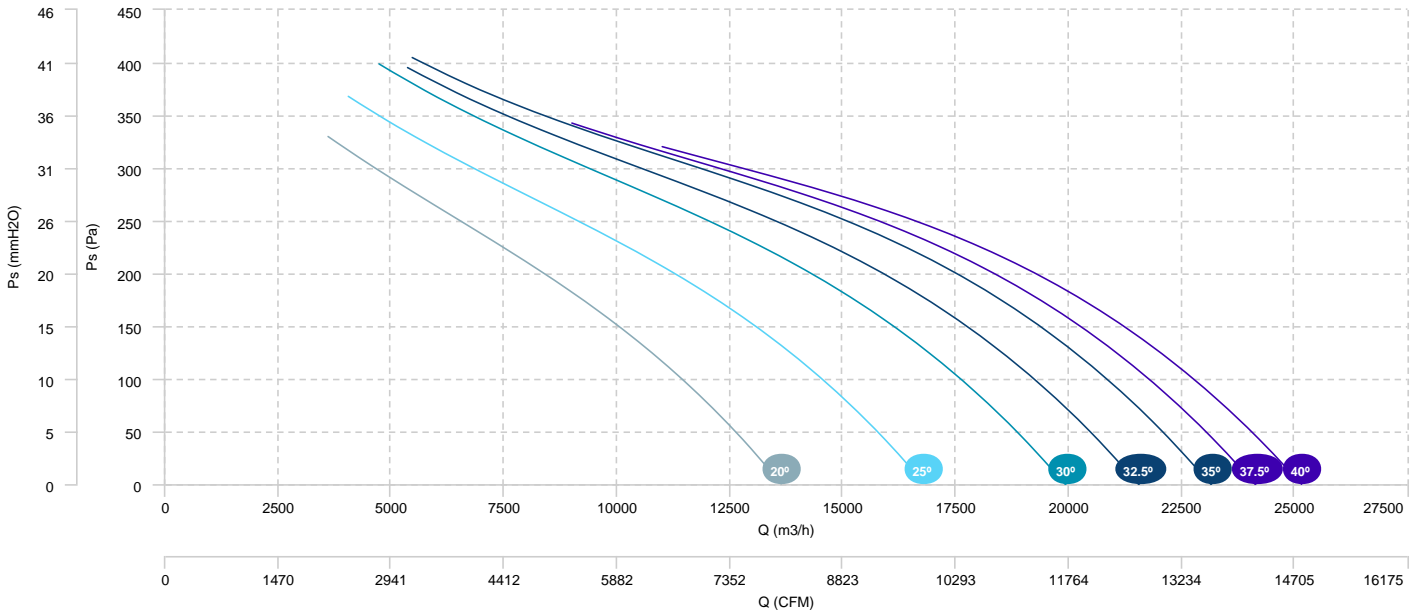

## AIR FLOW - ABSORBED POWER (4 poles)

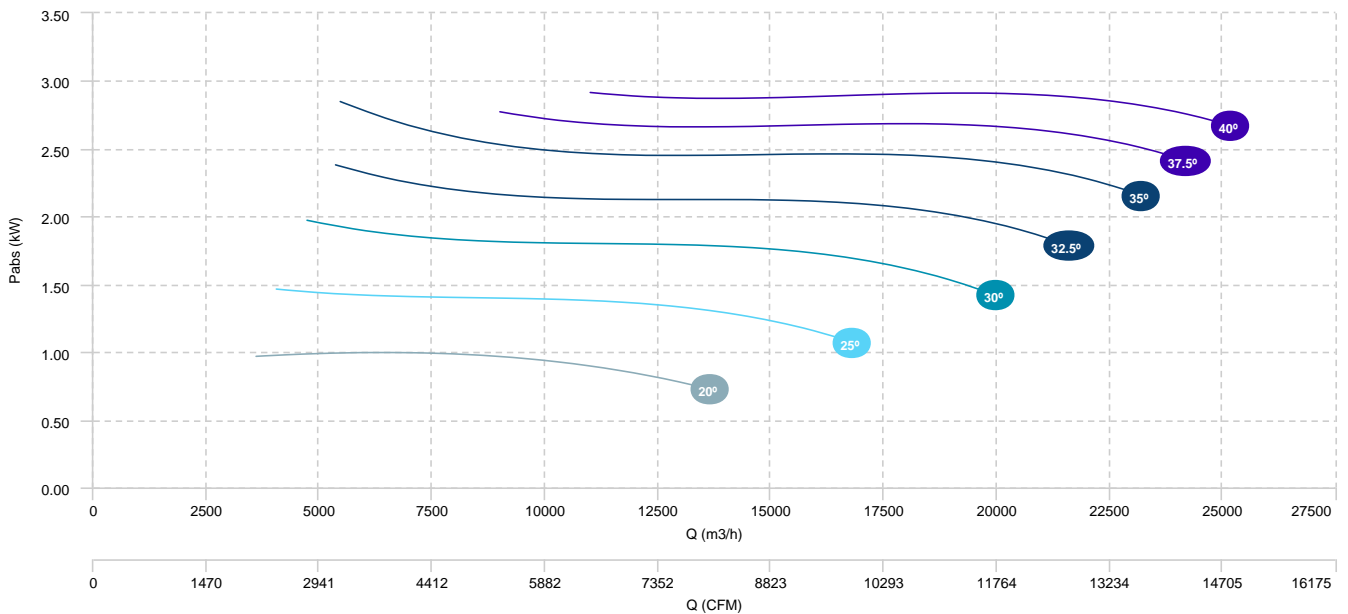



HM 71 T4/T8 0,75/0,12kW (A5:6)	HM 71 T4/T8 1,1/0,18kW (A5:6)	HM 71 T4/T8 1,5/0,25kW (A5:6)
HM 71 T4/T8 2,2/0,37kW (A5:6)	HM 71 T4/T8 3/0,55kW (A5:6)	

## AIR FLOW - PRESSURE (8 poles)

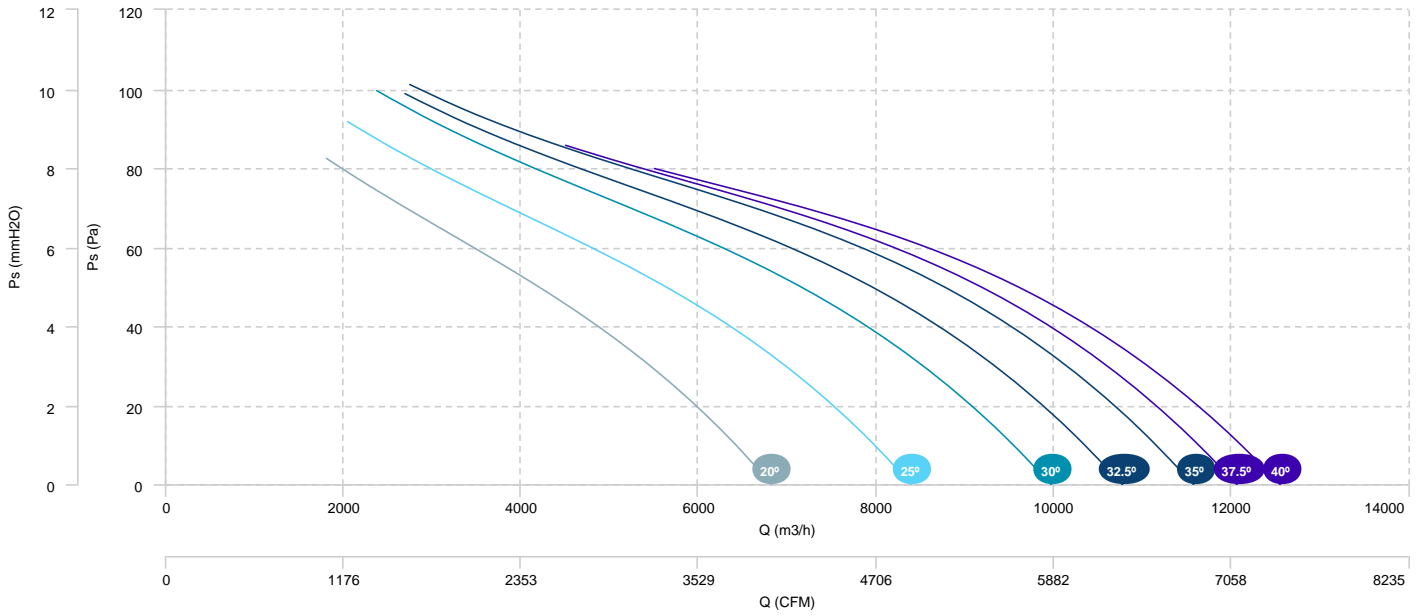

HM 80 T4 3kW (A5:6)

HM 80 T4 4kW (A5:6)

AIR FLOW - PRESSURE

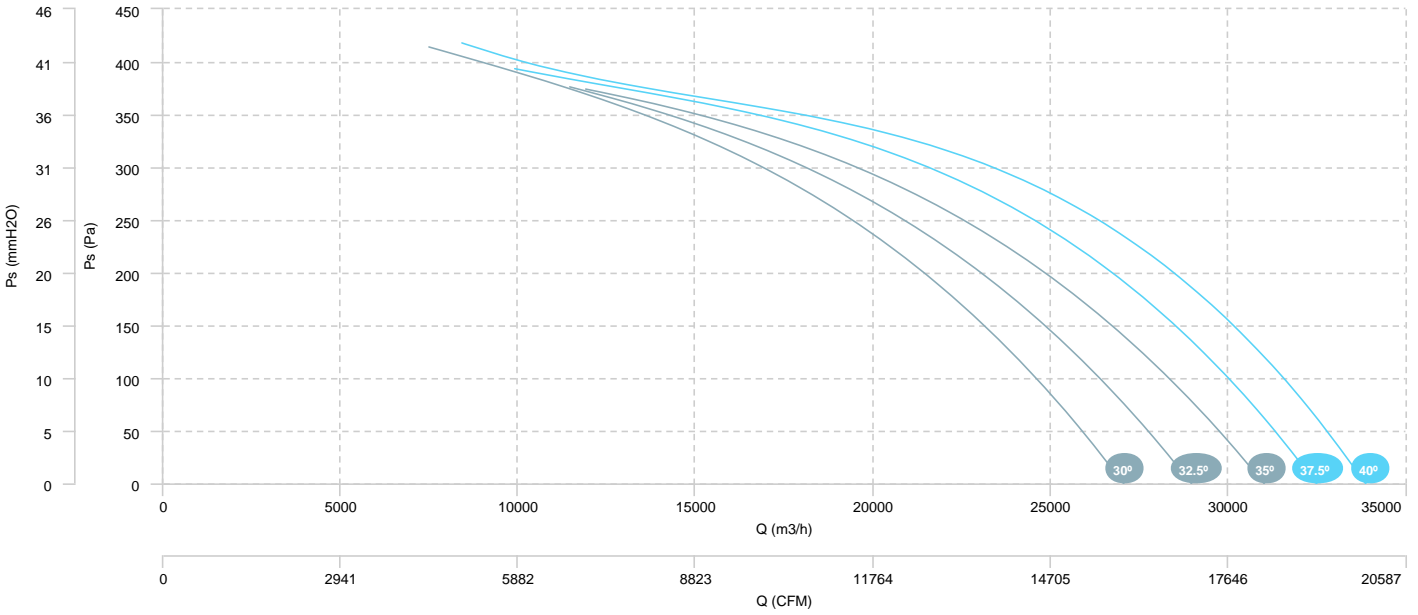

AIR FLOW - ABSORBED POWER

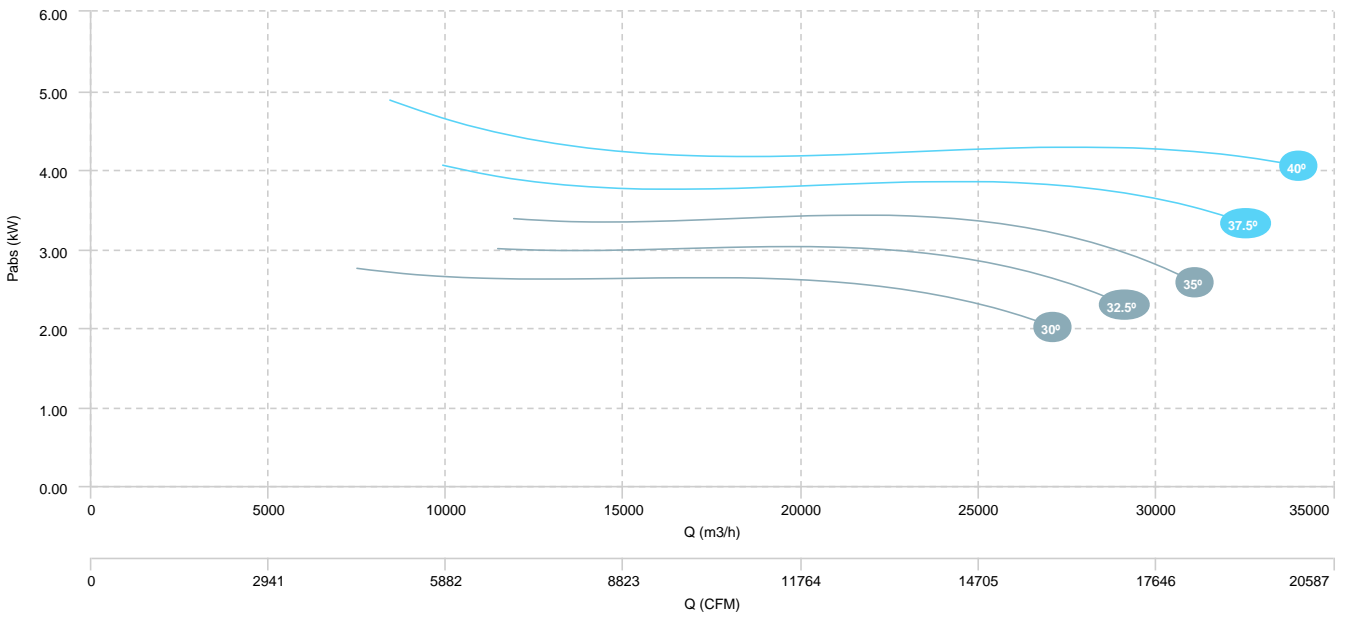

HM 80 T4 1,5kW (A2:9)	HM 80 T4 2,2kW (A2:9)	HM 80 T4 3kW (A2:9)
HM 80 T4 4kW (A2:9)	HM 80 T4 5,5kW (A2:9)	

## AIR FLOW - PRESSURE

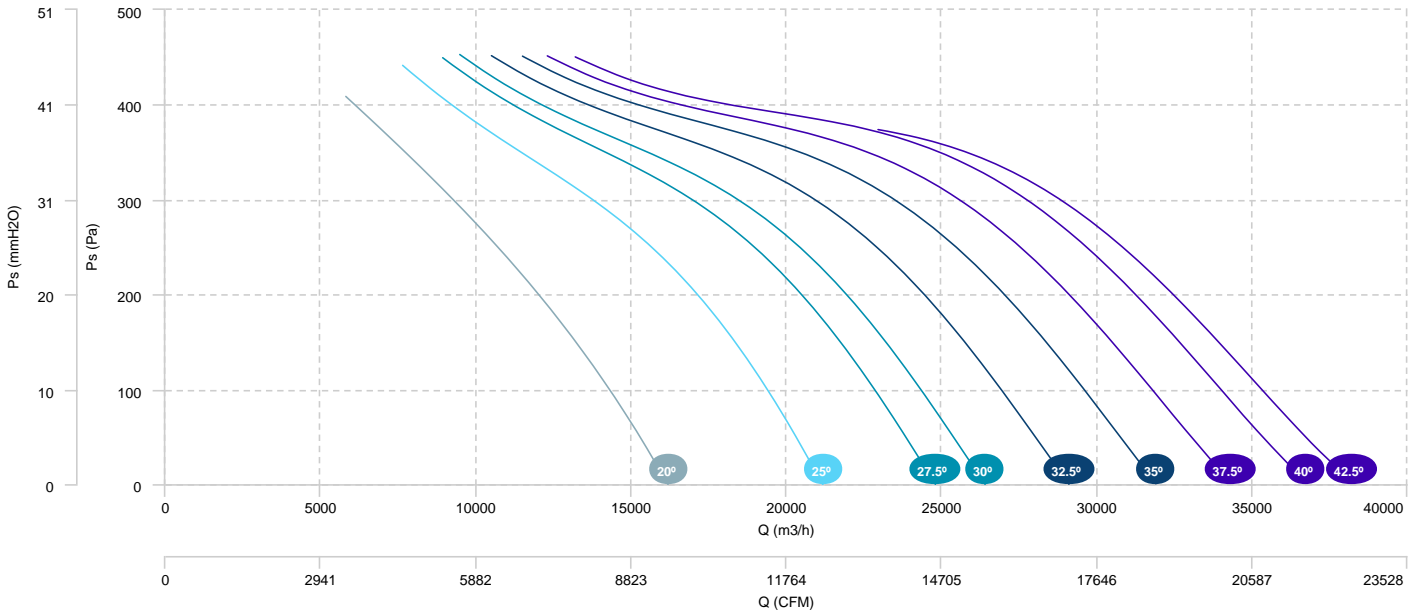

## AIR FLOW - ABSORBED POWER

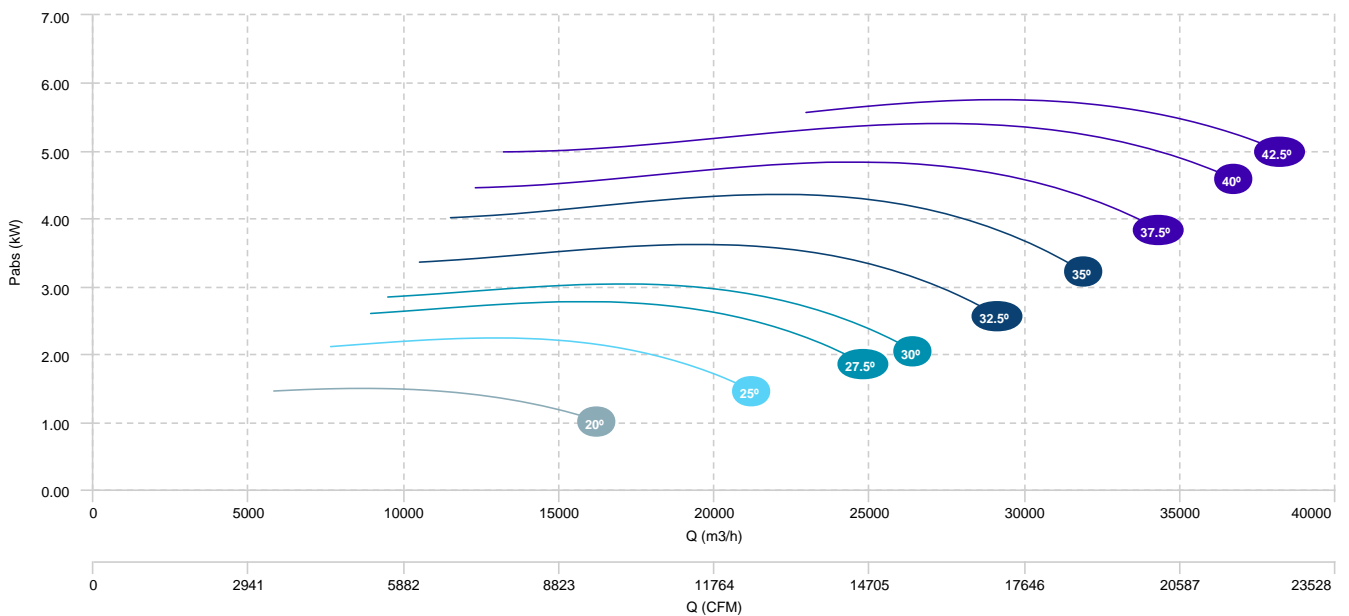

HM 80 T4 1,1KW (A2:6)	HM 80 T4 1,5KW (A2:6)	HM 80 T4 2,2kW (A2:6)
HM 80 T4 3kW (A2:6)	HM 80 T4 4kW (A2:6)	HM 80 T4 5,5kW (A2:6)

## AIR FLOW - PRESSURE

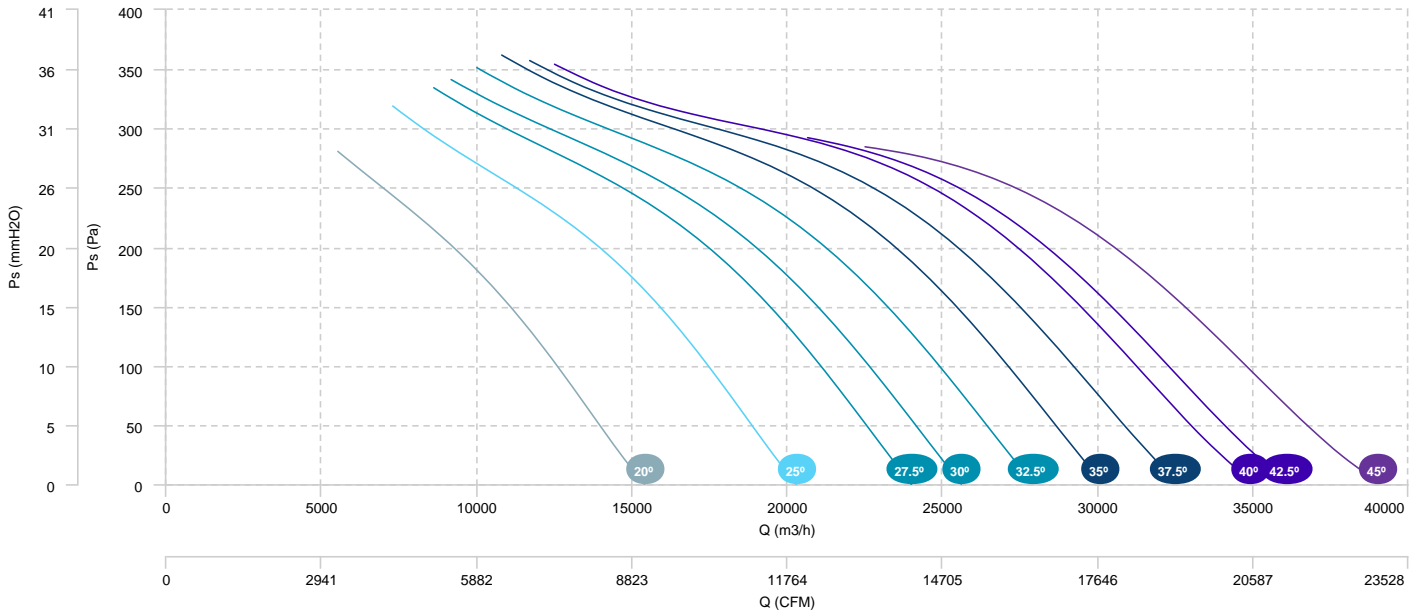

## AIR FLOW - ABSORBED POWER

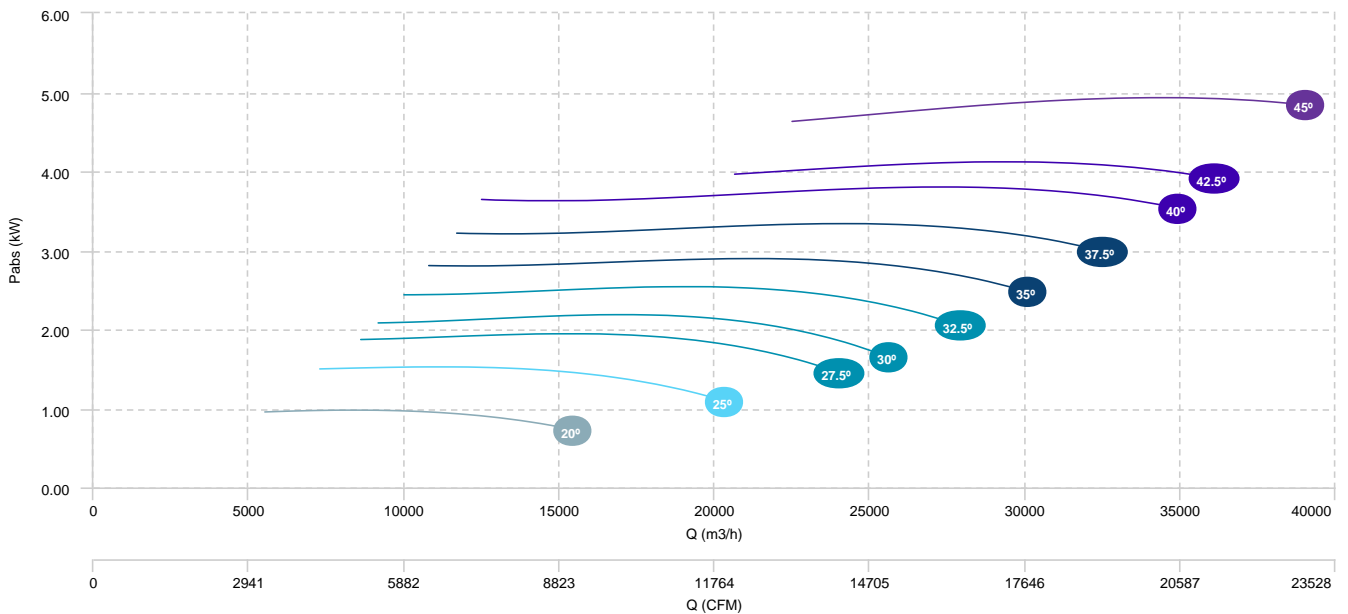

- HM 80 T6 0,75kW (A2:9)
- HM 80 T6 1,1kW (A2:9)
- HM 80 T6 1,5kW (A2:9)
- HM 80 T6 2,2kW (A2:9)

## AIR FLOW - PRESSURE

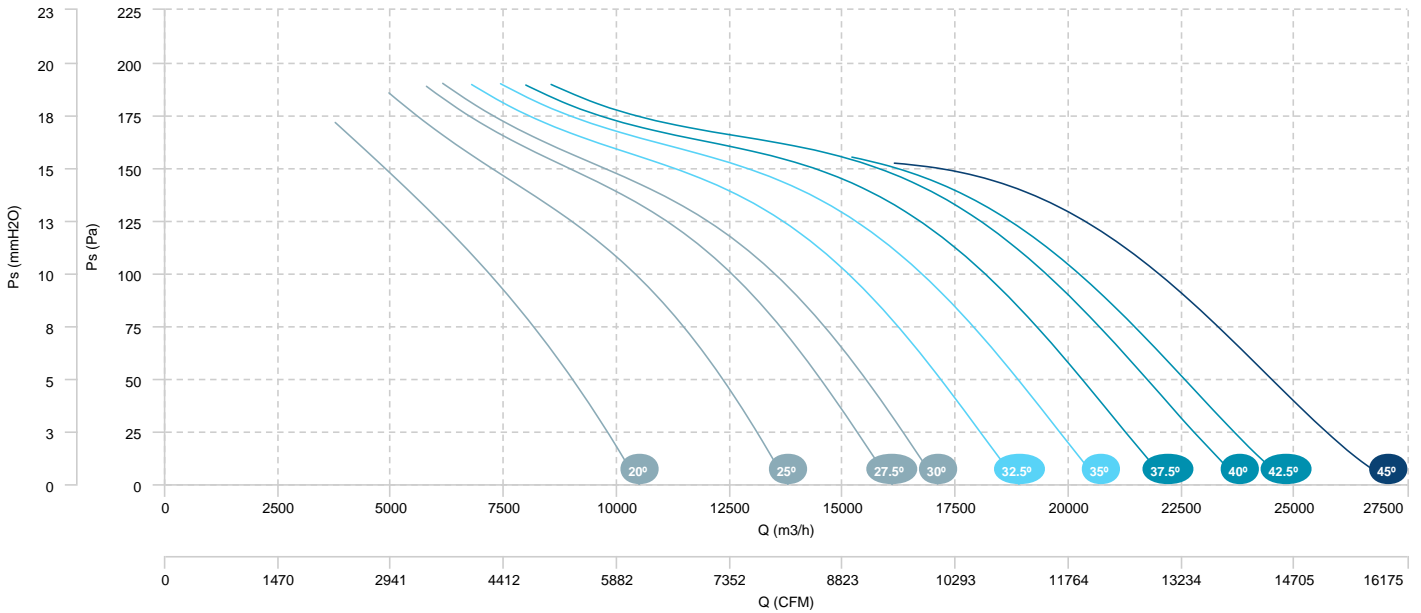

## AIR FLOW - ABSORBED POWER

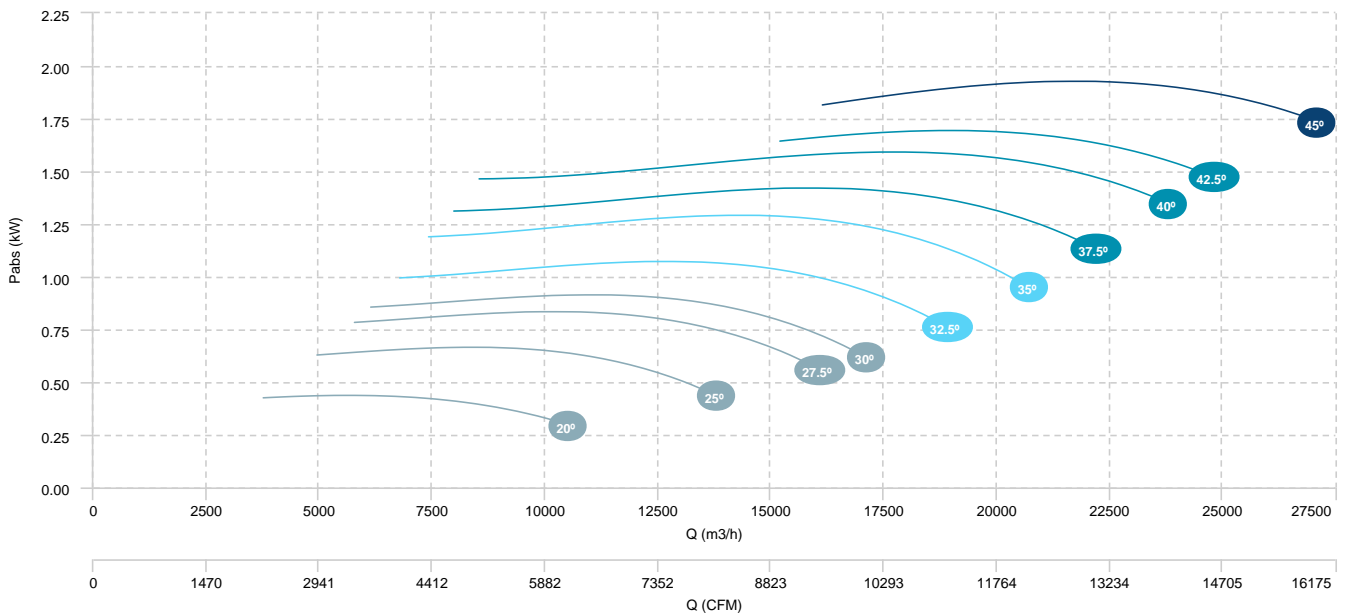

- HM 80 T6 0,75kW (A5:6)
- HM 80 T6 1,1kW (A5:6)
- HM 80 T6 1,5kW (A5:6)
- HM 80 T6 2,2kW (A5:6)

## AIR FLOW - PRESSURE

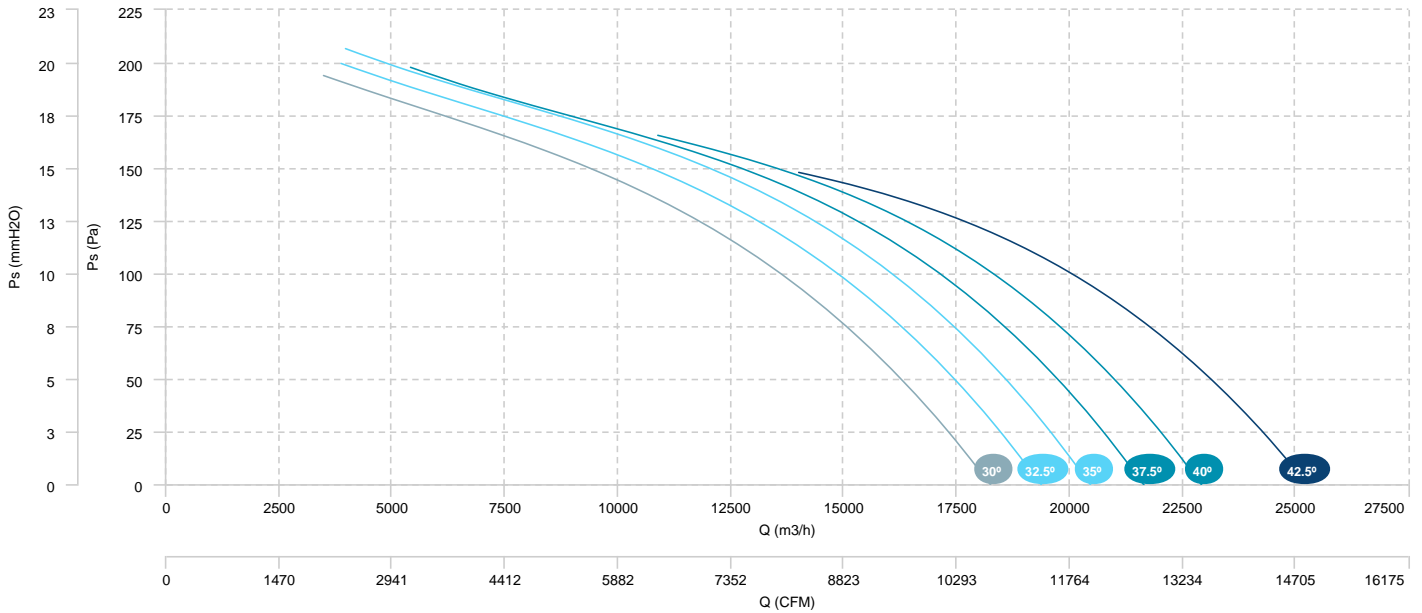

## AIR FLOW - ABSORBED POWER

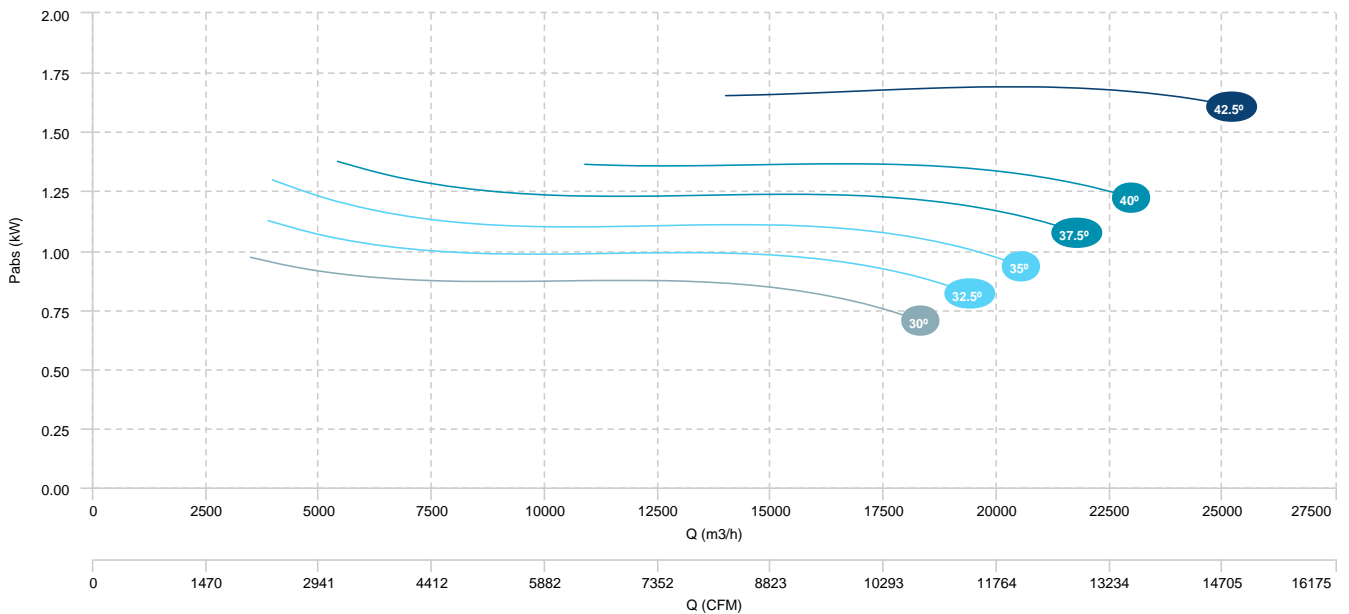

HM 80 T6 0,75kW (A2:6)

HM 80 T6 1,1kW (A2:6)

HM 80 T6 1,5KW (A2:6)

## AIR FLOW - PRESSURE

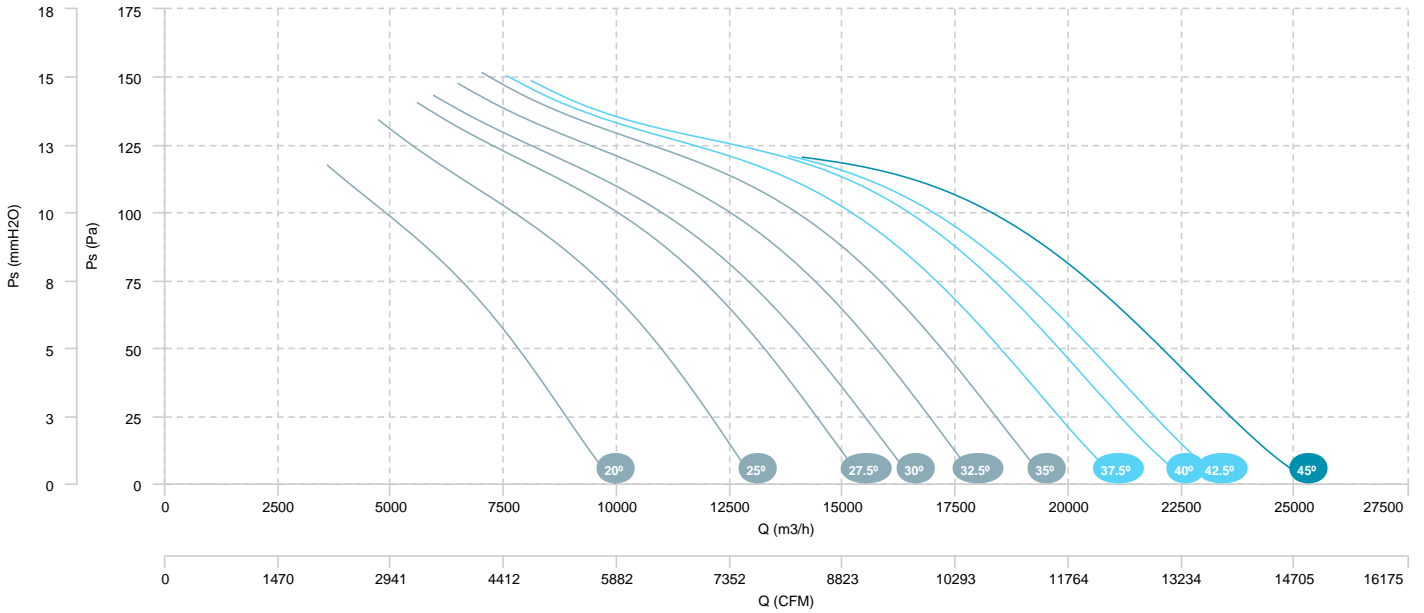

## AIR FLOW - ABSORBED POWER

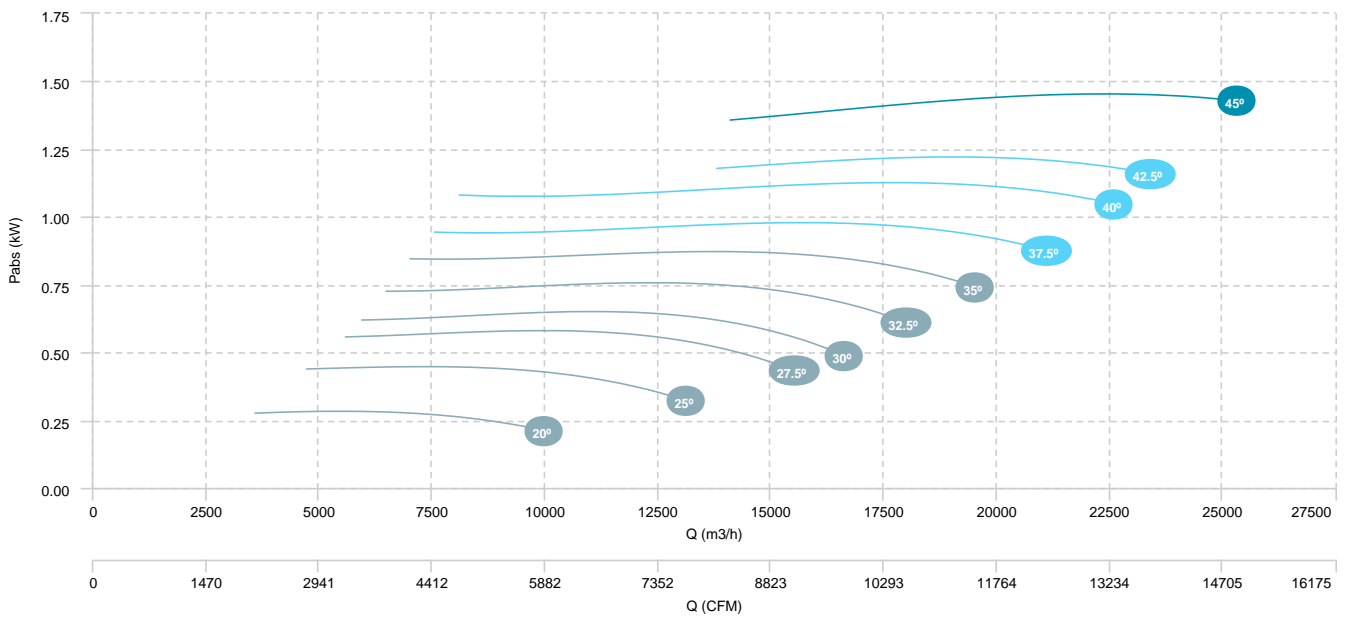

HM 80 T4/T6 1,5/0,5kW (A2:9)	HM 80 T4/T6 2,2/0,6kW (A2:9)	HM 80 T4/T6 3/0,9kW (A2:9)
HM 80 T4/T6 4/1,1kW (A2:9)	HM 80 T4/T6 5,5/1,85kW (A2:9)	

## AIR FLOW - PRESSURE (4 poles)

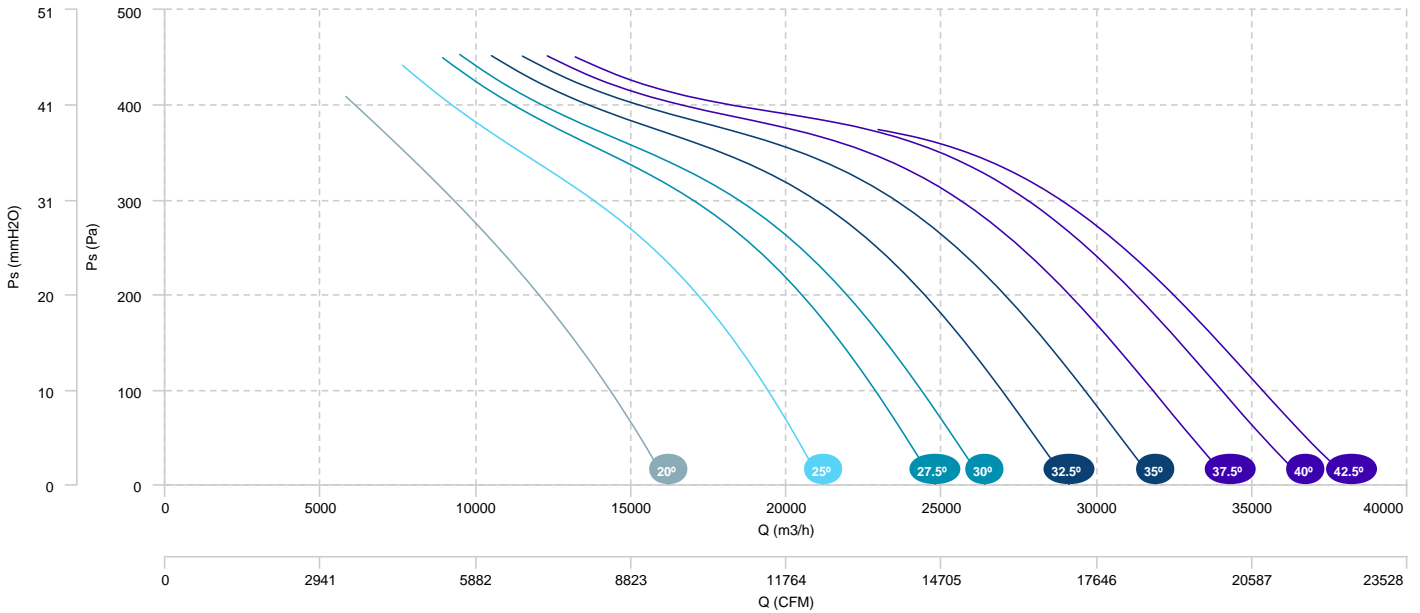

## AIR FLOW - ABSORBED POWER (4 poles)

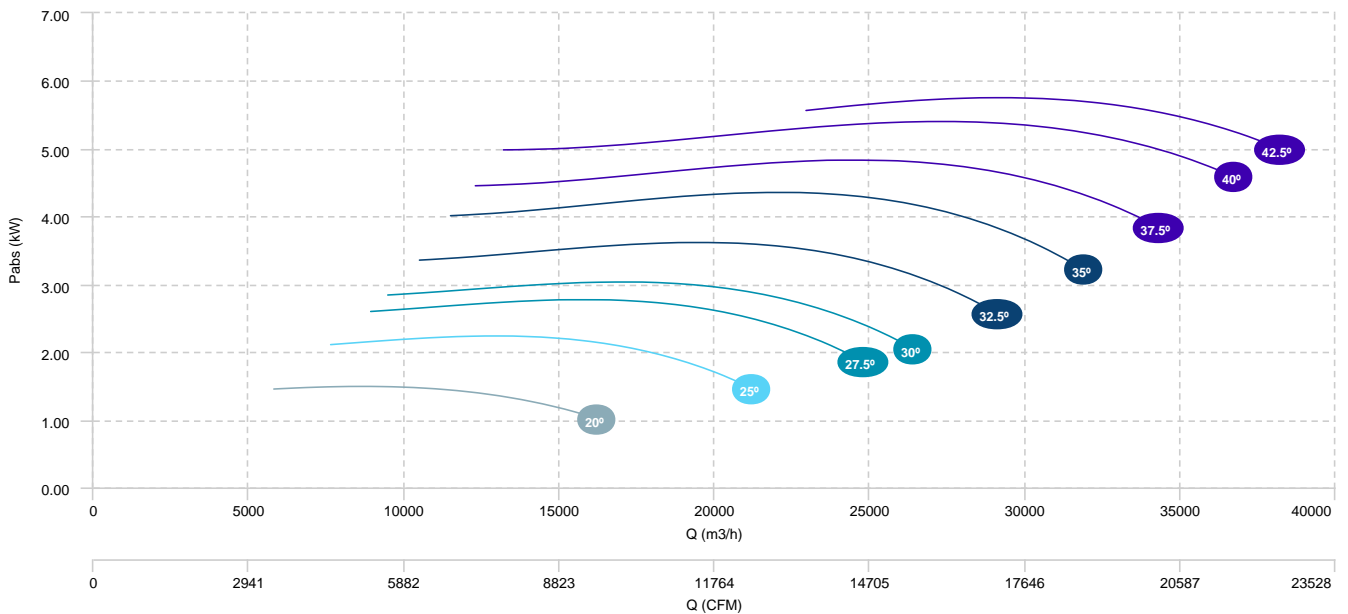



HM 80 T4/T6 1,5/0,5kW (A2:9)	HM 80 T4/T6 2,2/0,6kW (A2:9)	HM 80 T4/T6 3/0,9kW (A2:9)
HM 80 T4/T6 4/1,1kW (A2:9)	HM 80 T4/T6 5,5/1,85kW (A2:9)	

## AIR FLOW - PRESSURE (6 poles)

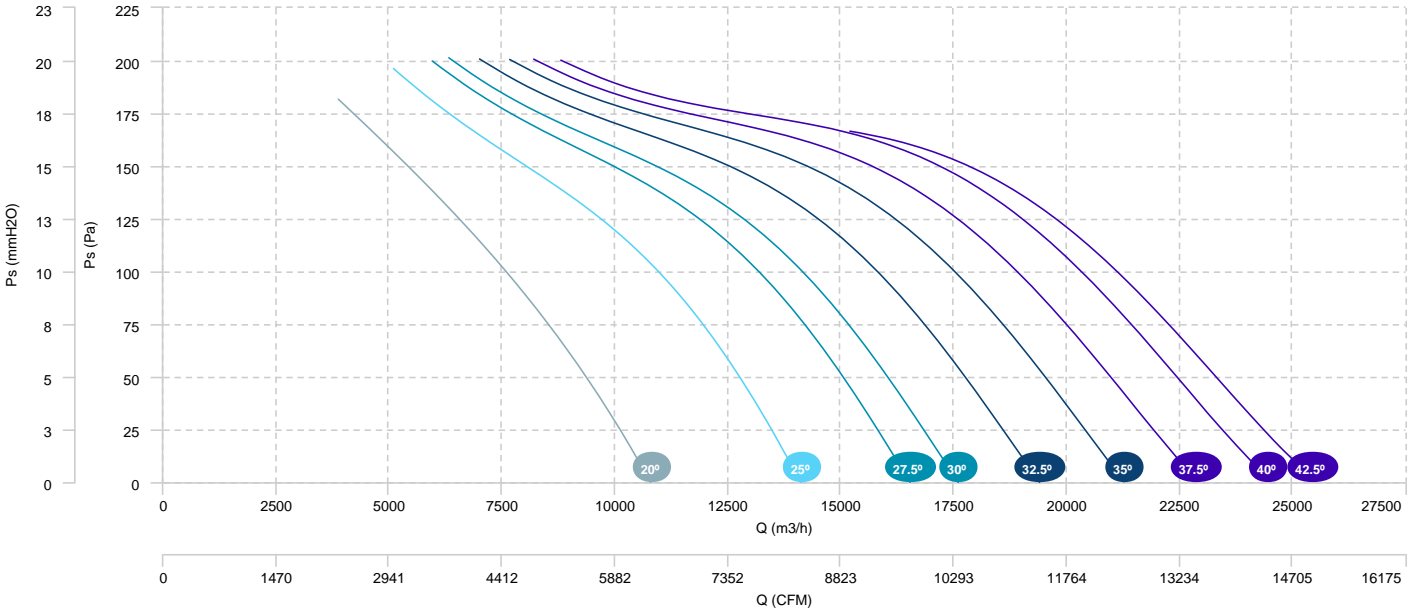

HM 80 T4/T6 3/0,9kW (A5:6)

HM 80 T4/T6 4/1,1kW (A5:6)

AIR FLOW - PRESSURE (4 poles)

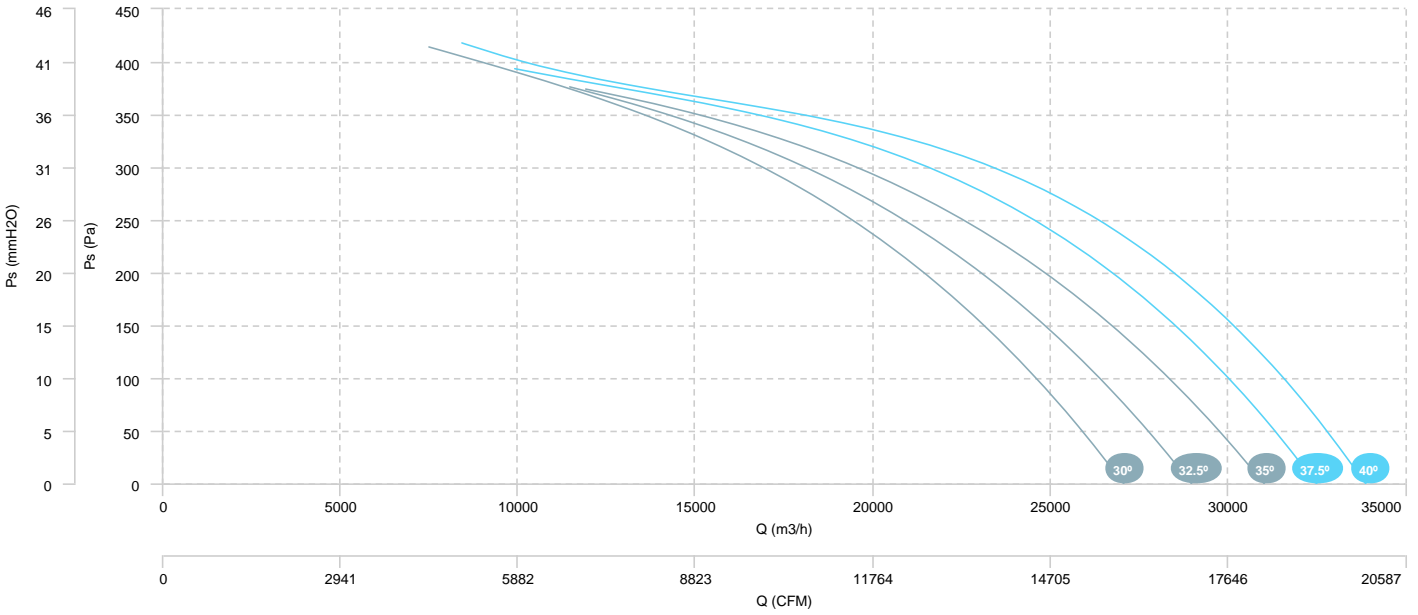

AIR FLOW - ABSORBED POWER (4 poles)

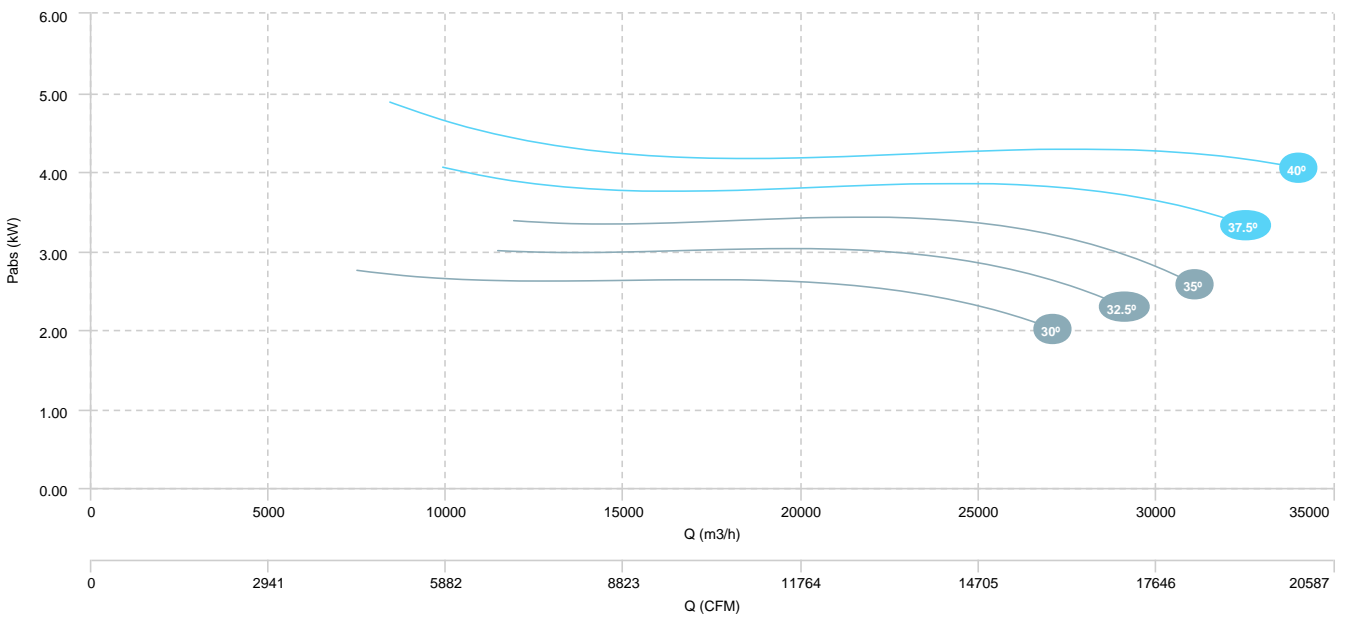

HM 80 T4/T6 3/0,9kW (A5:6)

HM 80 T4/T6 4/1,1kW (A5:6)

AIR FLOW - PRESSURE (6 poles)

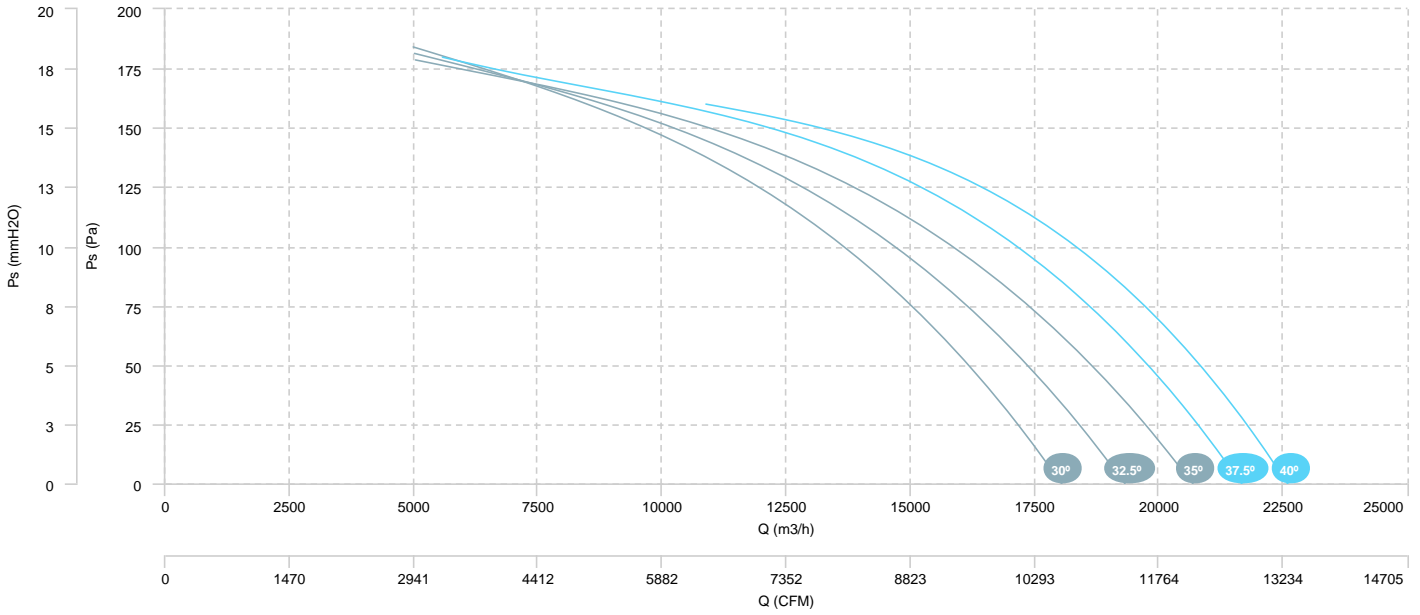

HM 80 T4/T6 1,1/0,37kW (A2:6)	HM 80 T4/T6 1,5/0,5kW (A2:6)	HM 80 T4/T6 2,2/0,6kW (A2:6)
HM 80 T4/T6 3/0,9kW (A2:6)	HM 80 T4/T6 4/1,1kW (A2:6)	HM 80 T4/T6 5,5/1,85kW (A2:6)

## AIR FLOW - PRESSURE (4 poles)

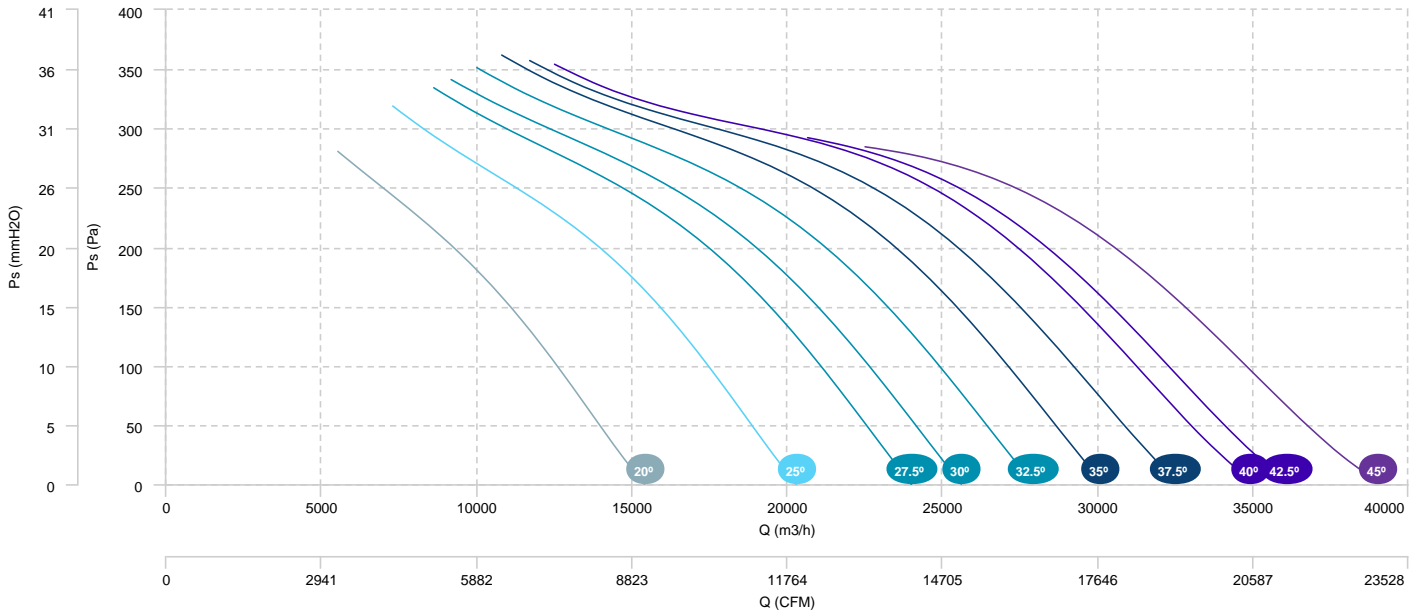

## AIR FLOW - ABSORBED POWER (4 poles)

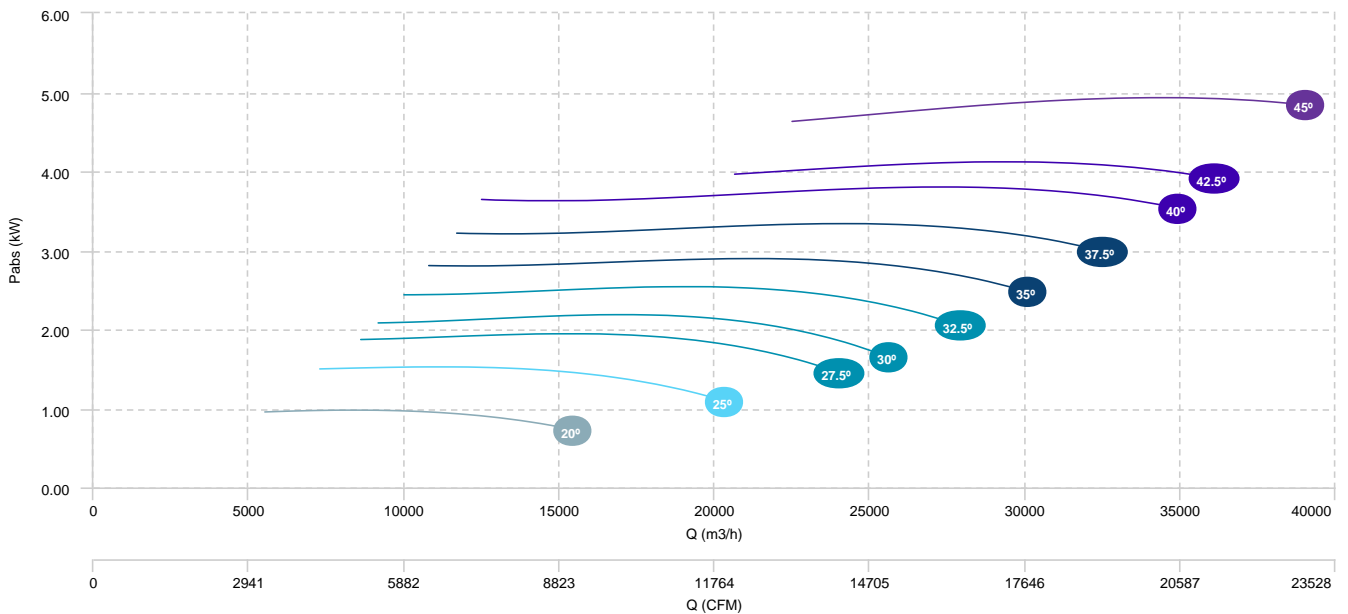

HM 80 T4/T6 1,1/0,37kW (A2:6)	HM 80 T4/T6 1,5/0,5kW (A2:6)	HM 80 T4/T6 2,2/0,6kW (A2:6)
HM 80 T4/T6 3/0,9kW (A2:6)	HM 80 T4/T6 4/1,1kW (A2:6)	HM 80 T4/T6 5,5/1,85kW (A2:6)

## AIR FLOW - PRESSURE (6 poles)

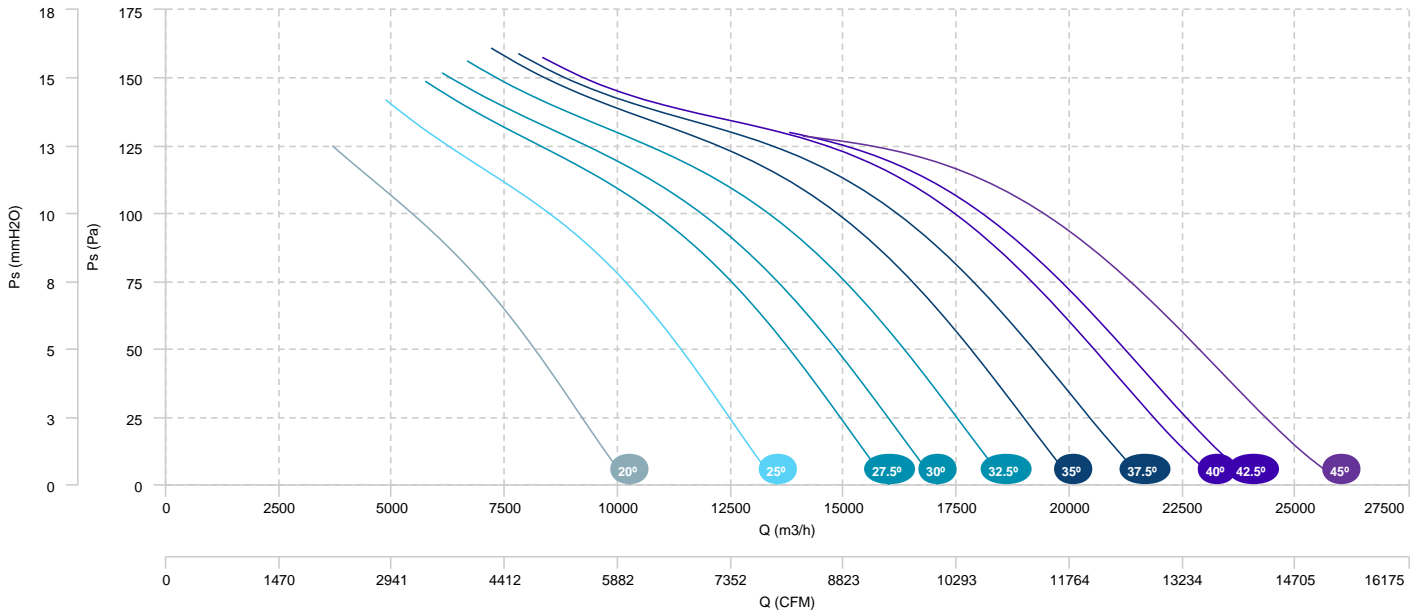

HM 80 T4/T8 3/0,55kW (A5:6)

HM 80 T4/T8 4/0,75kW (A5:6)

AIR FLOW - PRESSURE (4 poles)

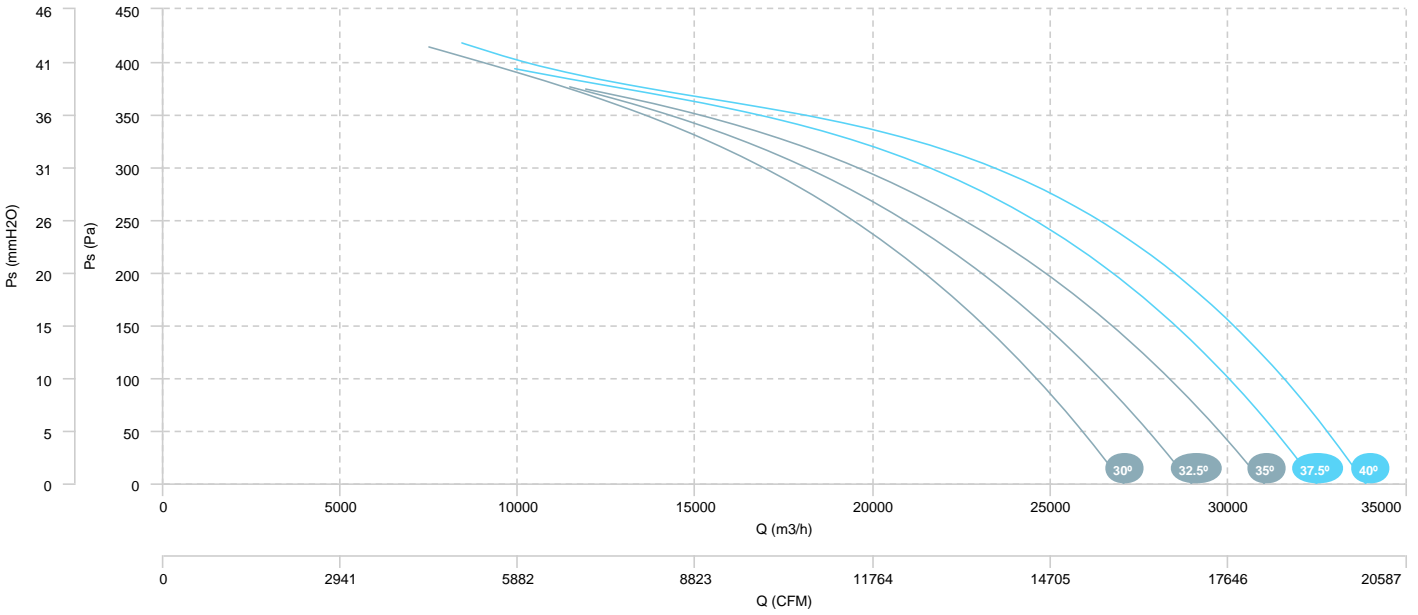

AIR FLOW - ABSORBED POWER (4 poles)

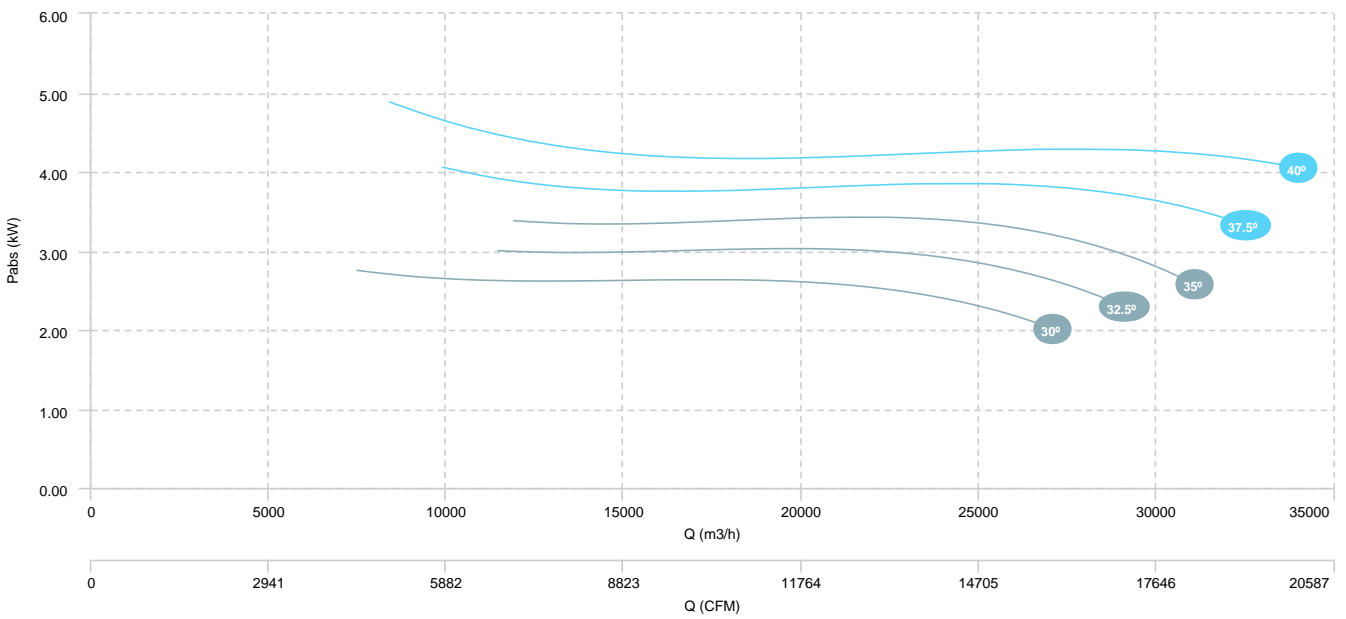

HM 80 T4/T8 3/0,55kW (A5:6)

HM 80 T4/T8 4/0,75kW (A5:6)

AIR FLOW - PRESSURE (8 poles)

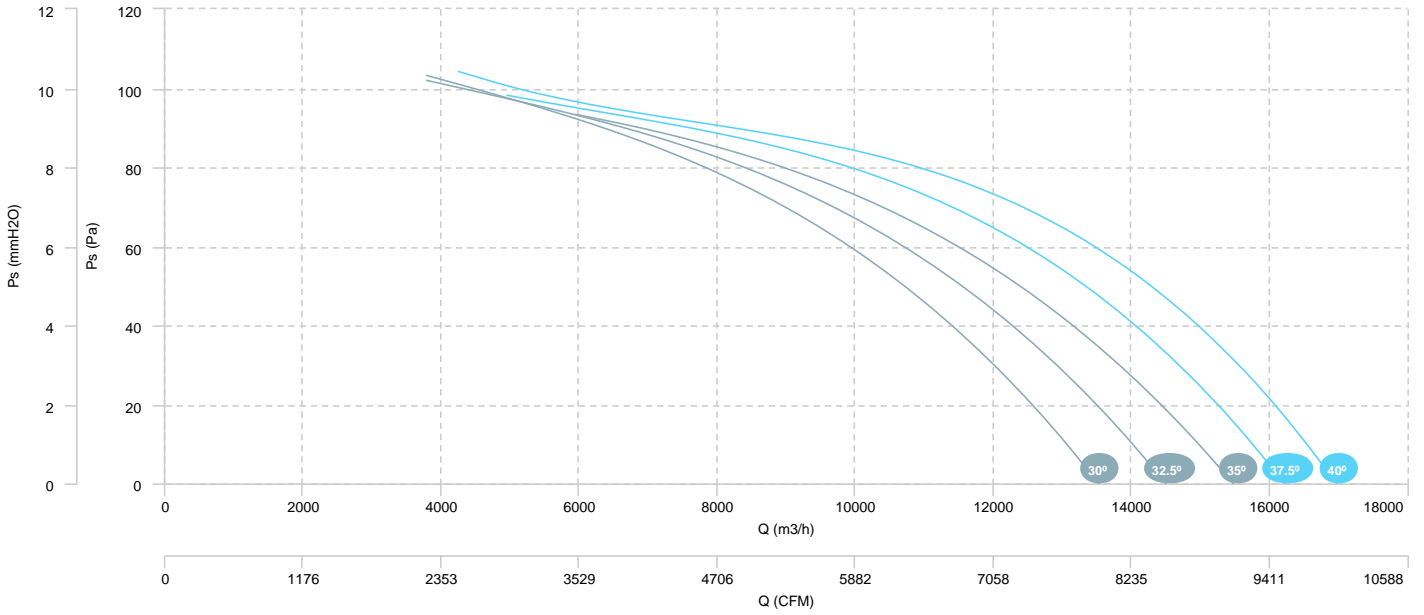

HM 80 T4/T8 1,1/0,18kW (A2:6)	HM 80 T4/T8 1,5/0,25kW (A2:6)	HM 80 T4/T8 2,2/0,37kW (A2:6)
HM 80 T4/T8 3/0,55kW (A2:6)	HM 80 T4/T8 4/0,75kW (A2:6)	HM 80 T4/T8 5,5/1,1kW (A2:6)

## AIR FLOW - PRESSURE (4 poles)

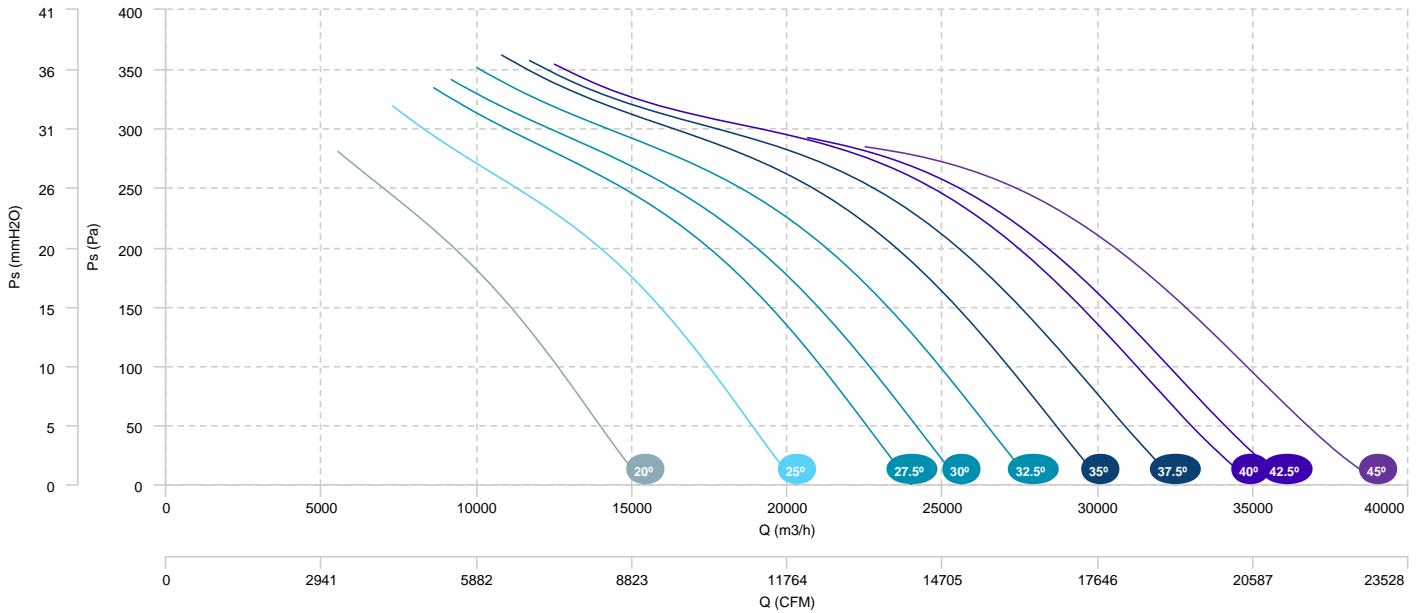

## AIR FLOW - ABSORBED POWER (4 poles)

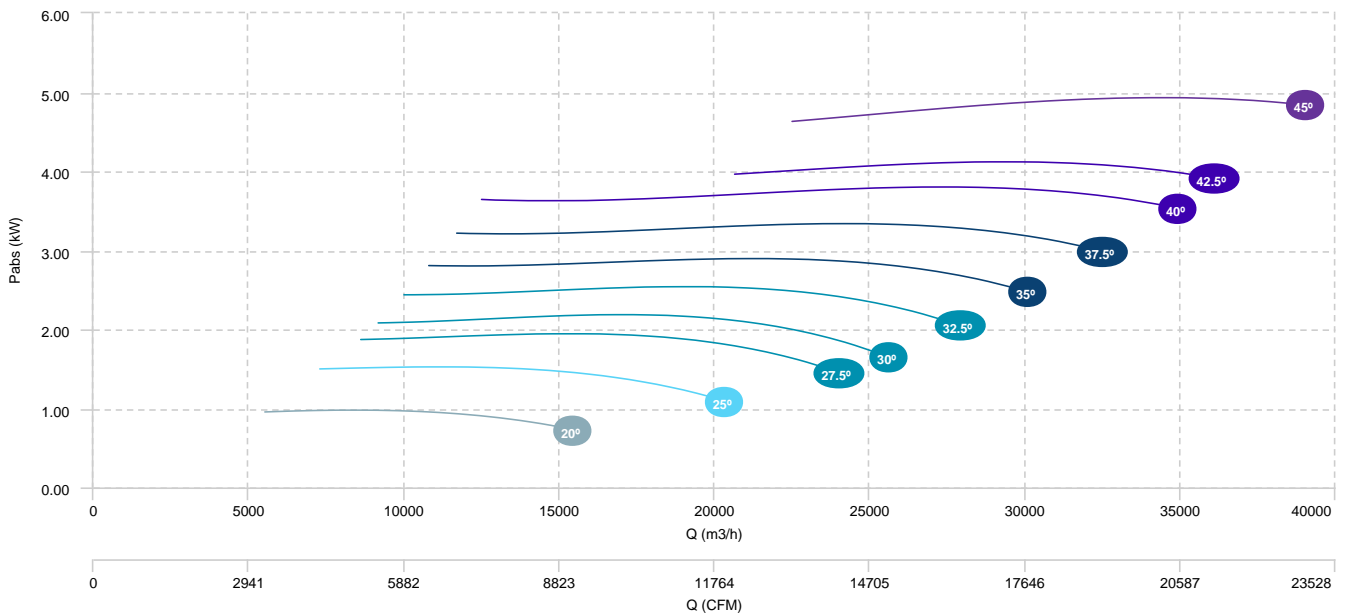



HM 80 T4/T8 1,1/0,18kW (A2:6)	HM 80 T4/T8 1,5/0,25kW (A2:6)	HM 80 T4/T8 2,2/0,37kW (A2:6)
HM 80 T4/T8 3/0,55kW (A2:6)	HM 80 T4/T8 4/0,75kW (A2:6)	HM 80 T4/T8 5,5/1,1kW (A2:6)

**AIR FLOW - PRESSURE (8 poles)**

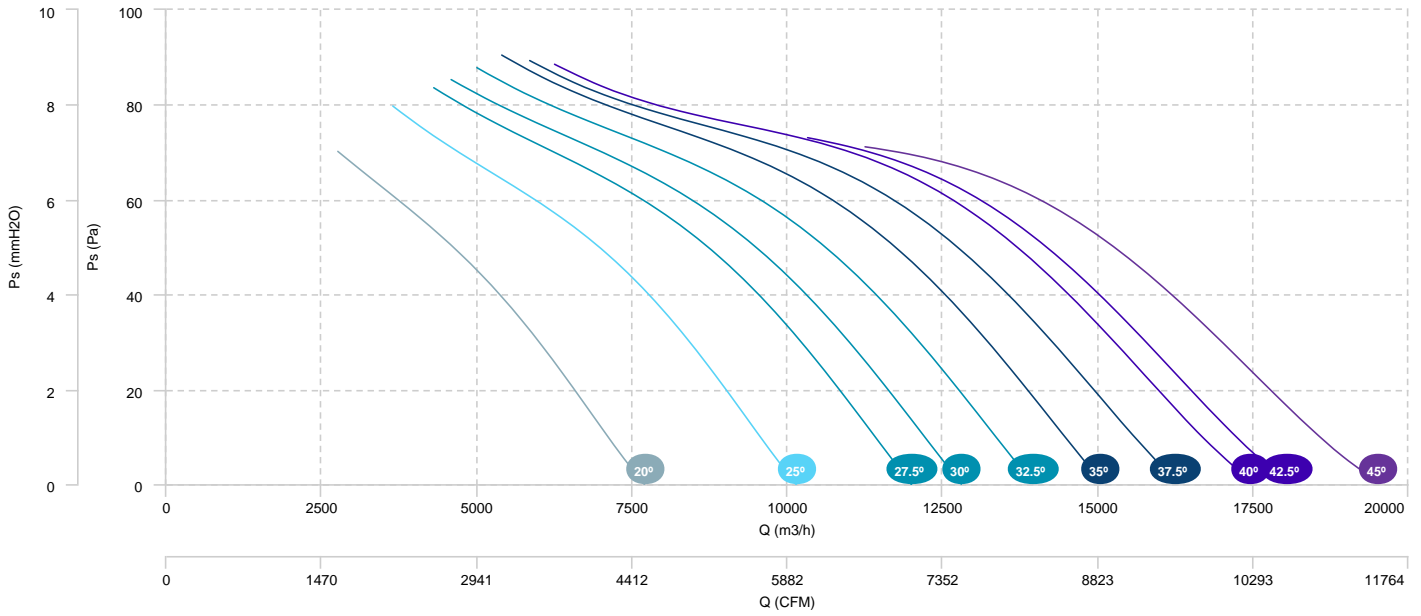

HM 80 T4/T8 1,5/0,25kW (A2:9)	HM 80 T4/T8 2,2/0,37kW (A2:9)	HM 80 T4/T8 3/0,55kW (A2:9)
HM 80 T4/T8 4/0,75kW (A2:9)	HM 80 T4/T8 5,5/1,1kW (A2:9)	

## AIR FLOW - PRESSURE (4 poles)

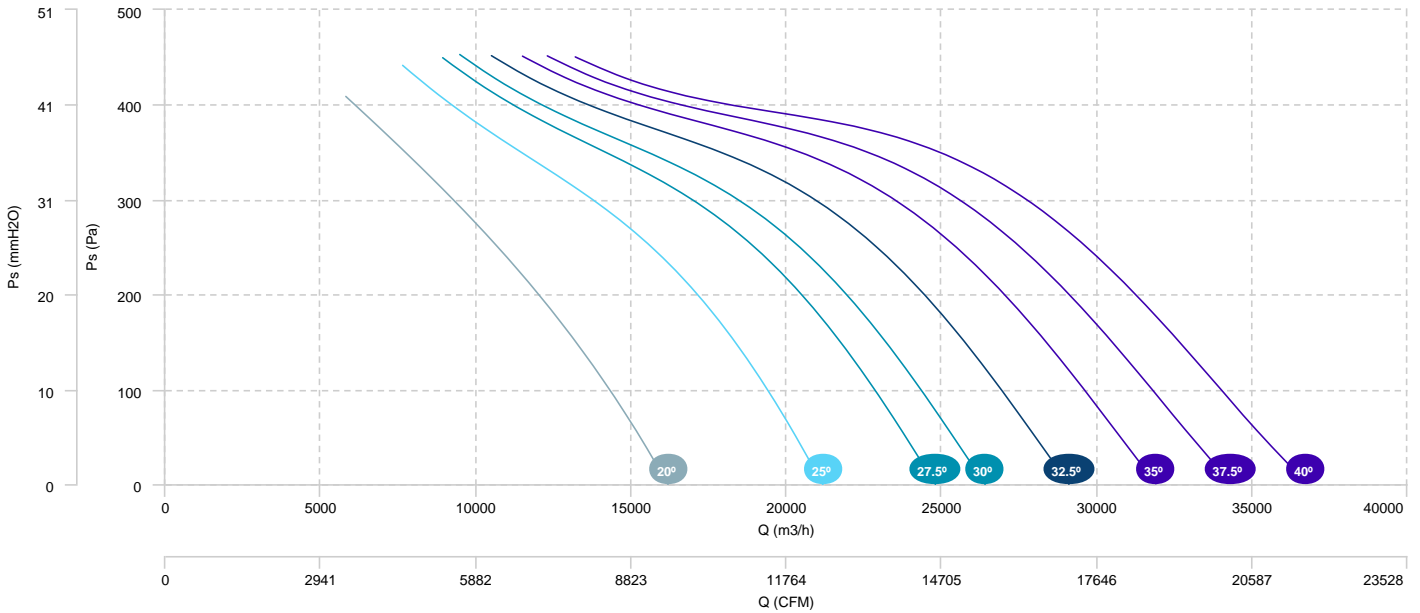

## AIR FLOW - ABSORBED POWER (4 poles)

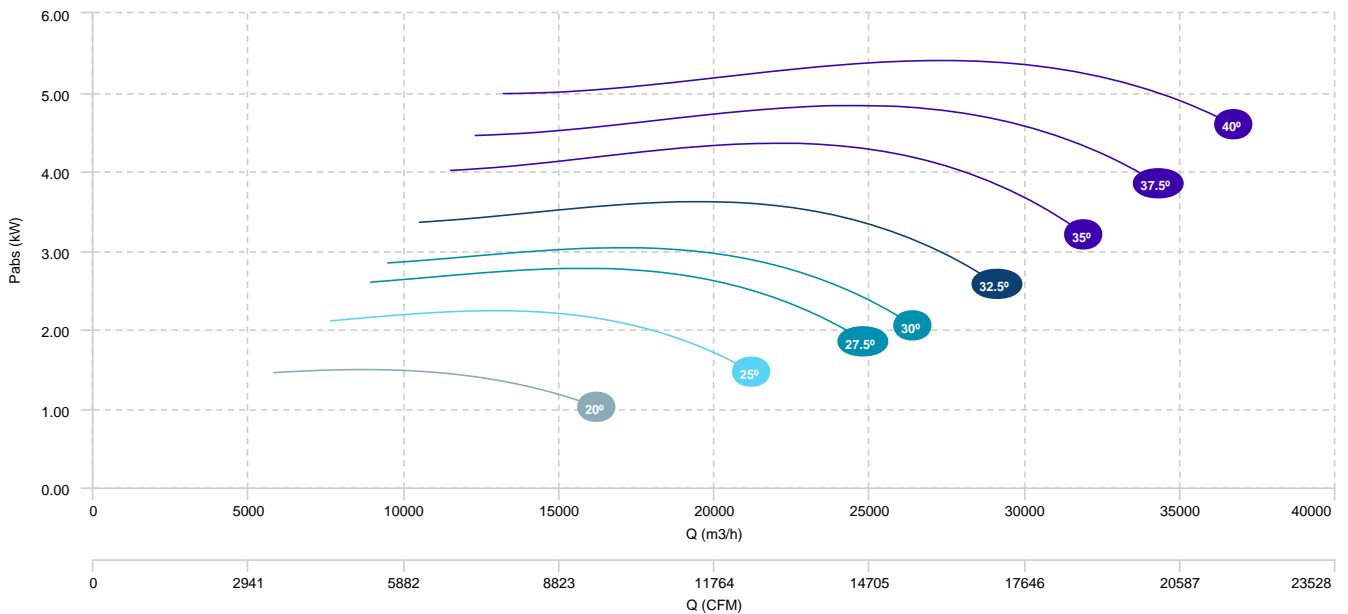

HM 80 T4/T8 1,5/0,25kW (A2:9)	HM 80 T4/T8 2,2/0,37kW (A2:9)	HM 80 T4/T8 3/0,55kW (A2:9)
HM 80 T4/T8 4/0,75kW (A2:9)	HM 80 T4/T8 5,5/1,1kW (A2:9)	

**AIR FLOW - PRESSURE (8 poles)**

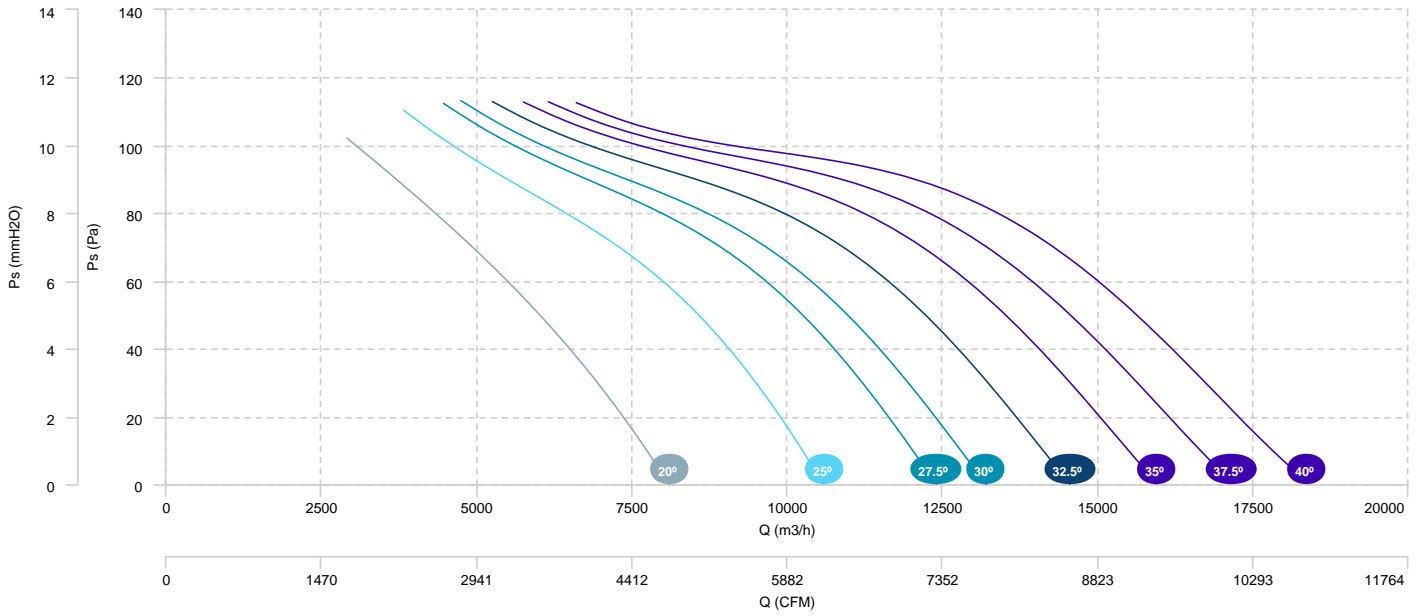

- HM 90 T4 5,5kW (A6:6)
- HM 90 T4 7,5kW (A6:6)
- HM 90 T4 11kW (A6:6)
- HM 90 T4 15kW (A6:6)

## AIR FLOW - PRESSURE

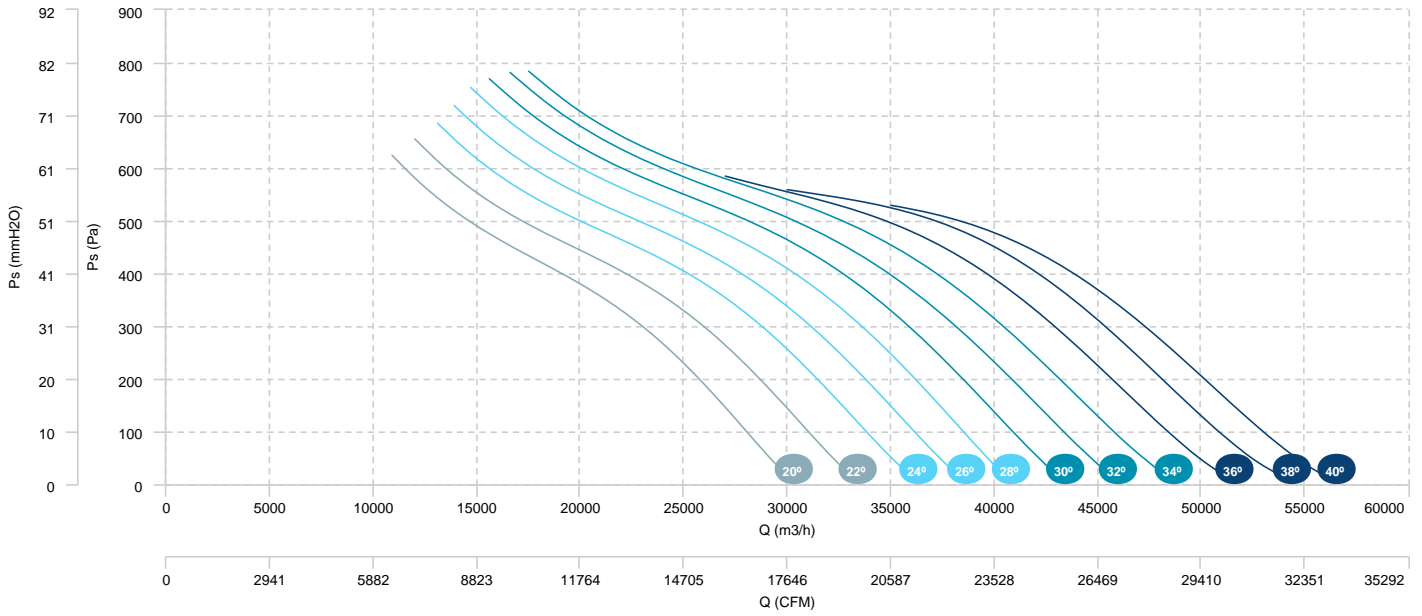

## AIR FLOW - ABSORBED POWER

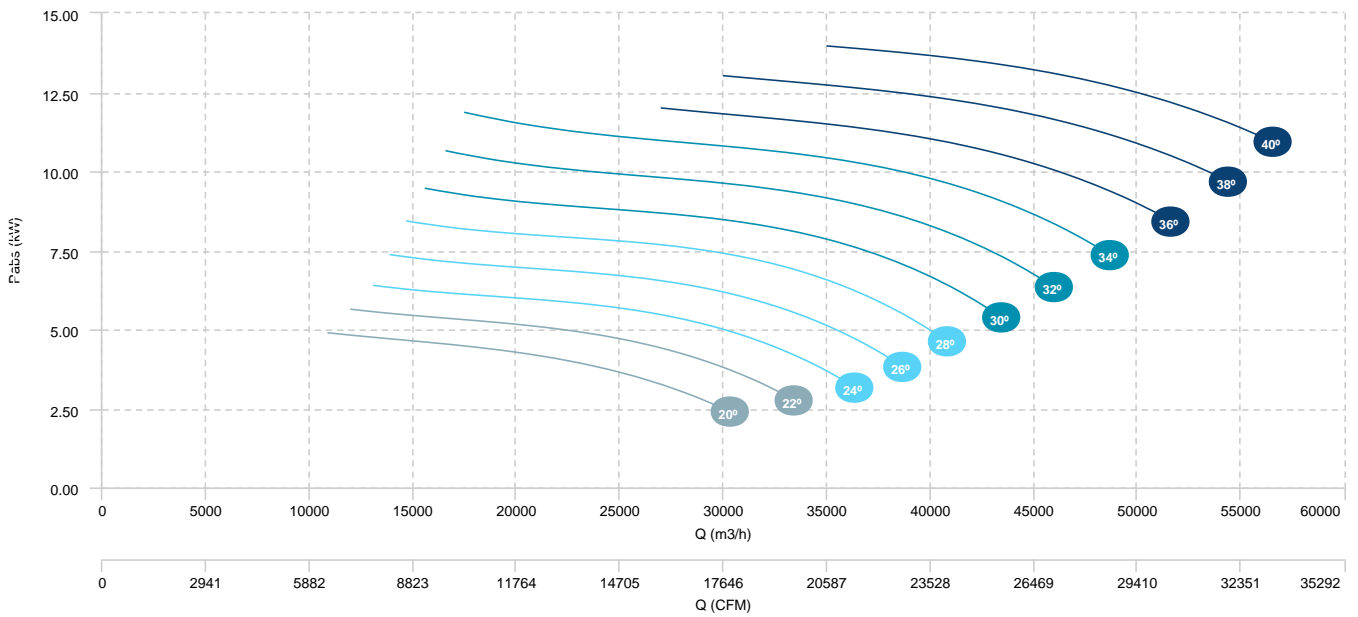

HM 90 T4 3kW (A6:3)	HM 90 T4 4kW (A6:3)	HM 90 T4 5,5kW (A6:3)
HM 90 T4 7,5kW (A6:3)	HM 90 T4 11kW (A6:3)	

## AIR FLOW - PRESSURE

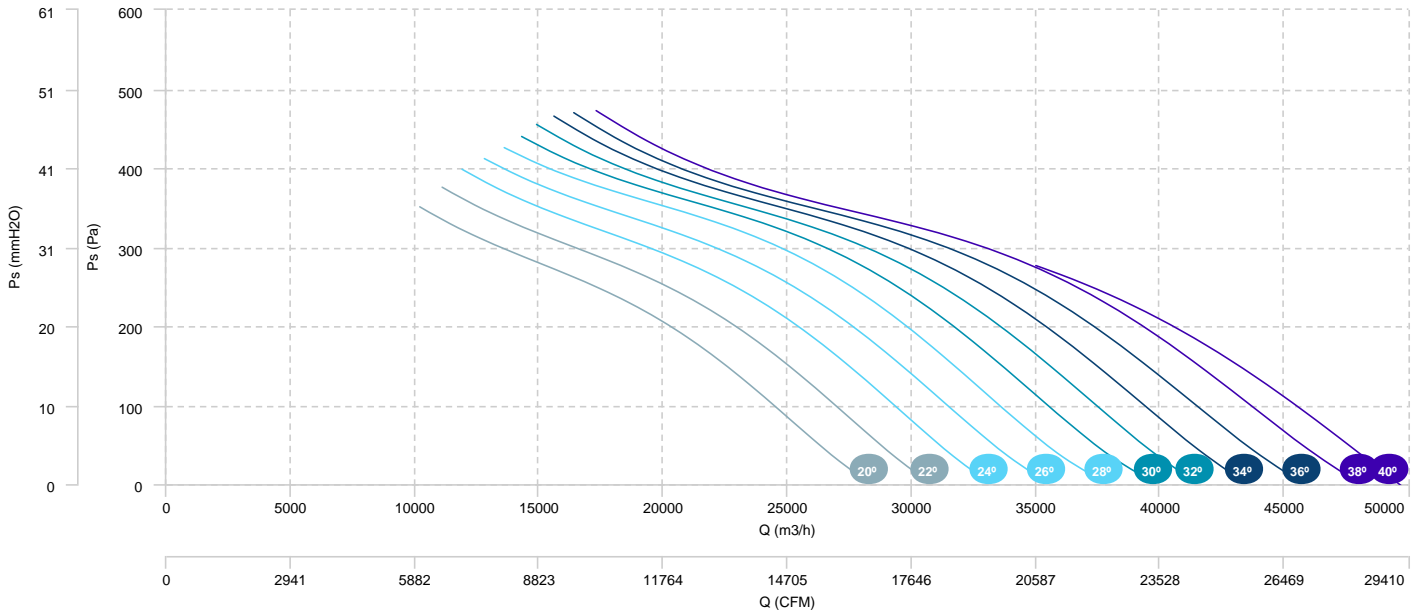

## AIR FLOW - ABSORBED POWER

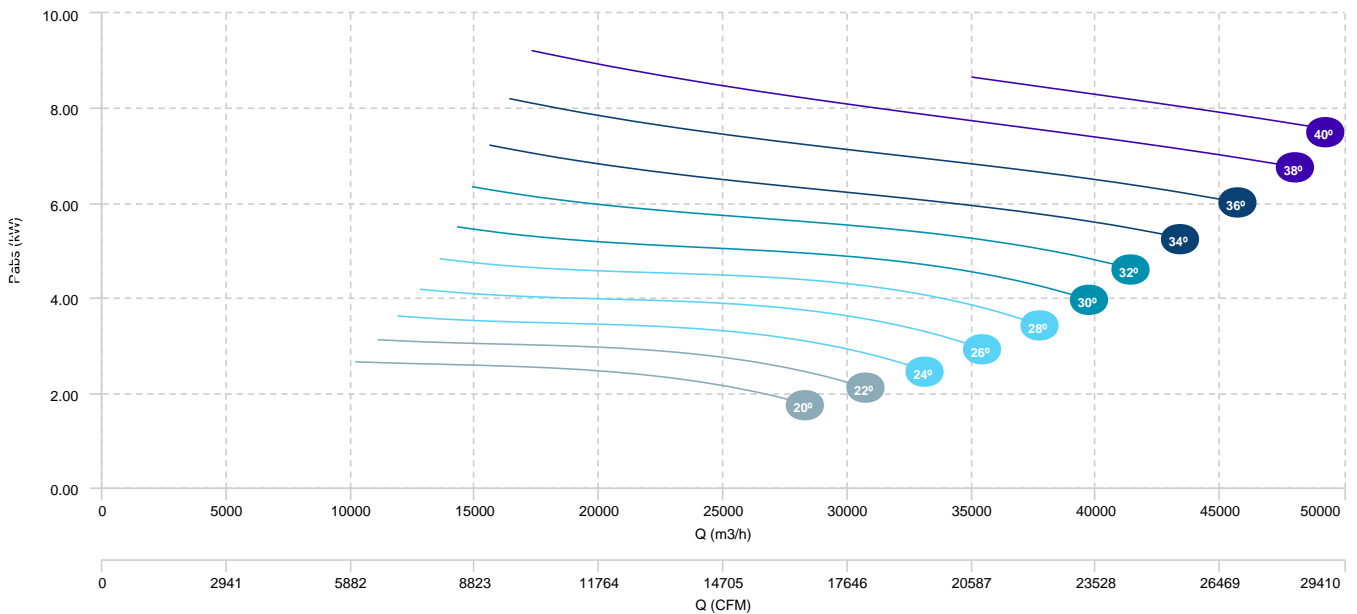

- HM 90 T6 1,5kW (A6:6)
- HM 90 T6 2,2kW (A6:6)
- HM 90 T6 3kW (A6:6)
- HM 90 T6 4kW (A6:6)

## AIR FLOW - PRESSURE

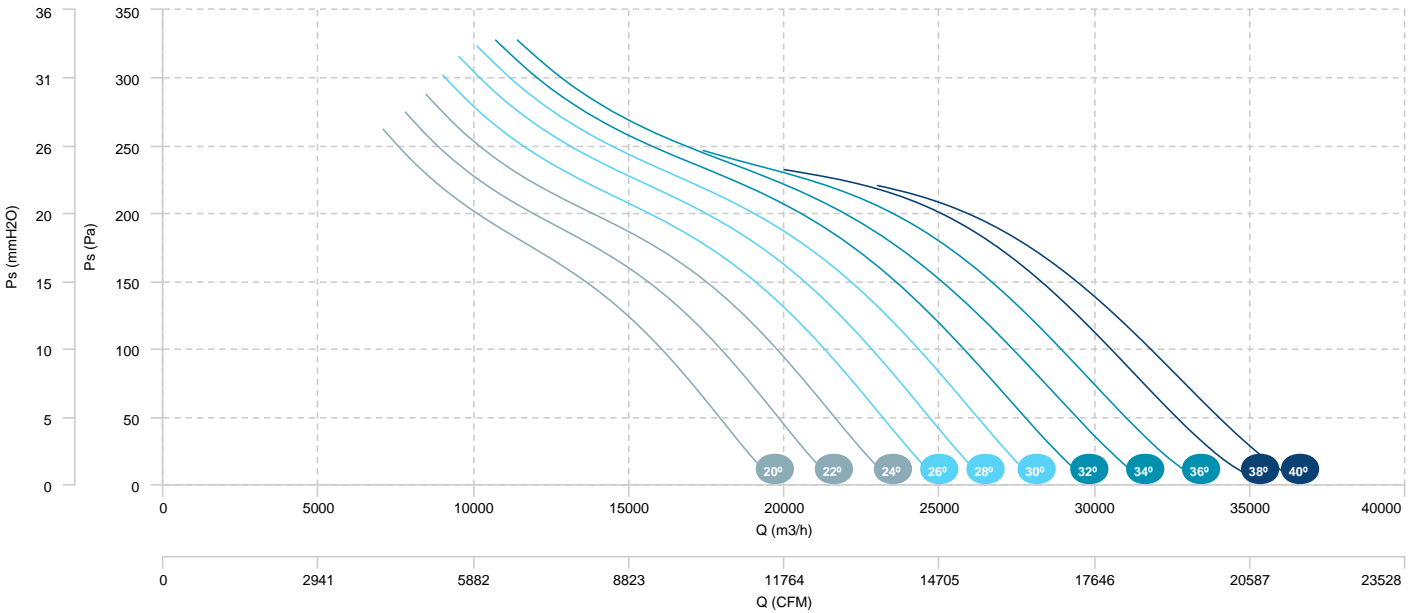

## AIR FLOW - ABSORBED POWER

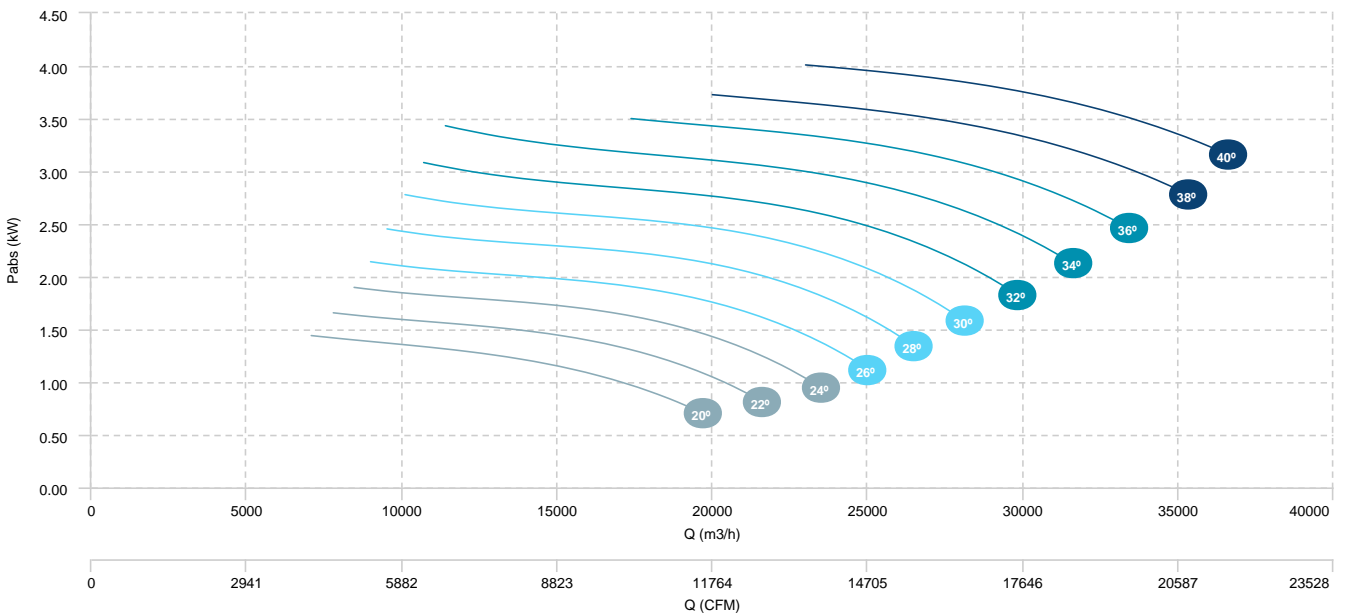

HM 90 T6 1,5kW (A6:3)

HM 90 T6 2,2kW (A6:3)

HM 90 T6 3kW (A6:3)

AIR FLOW - PRESSURE

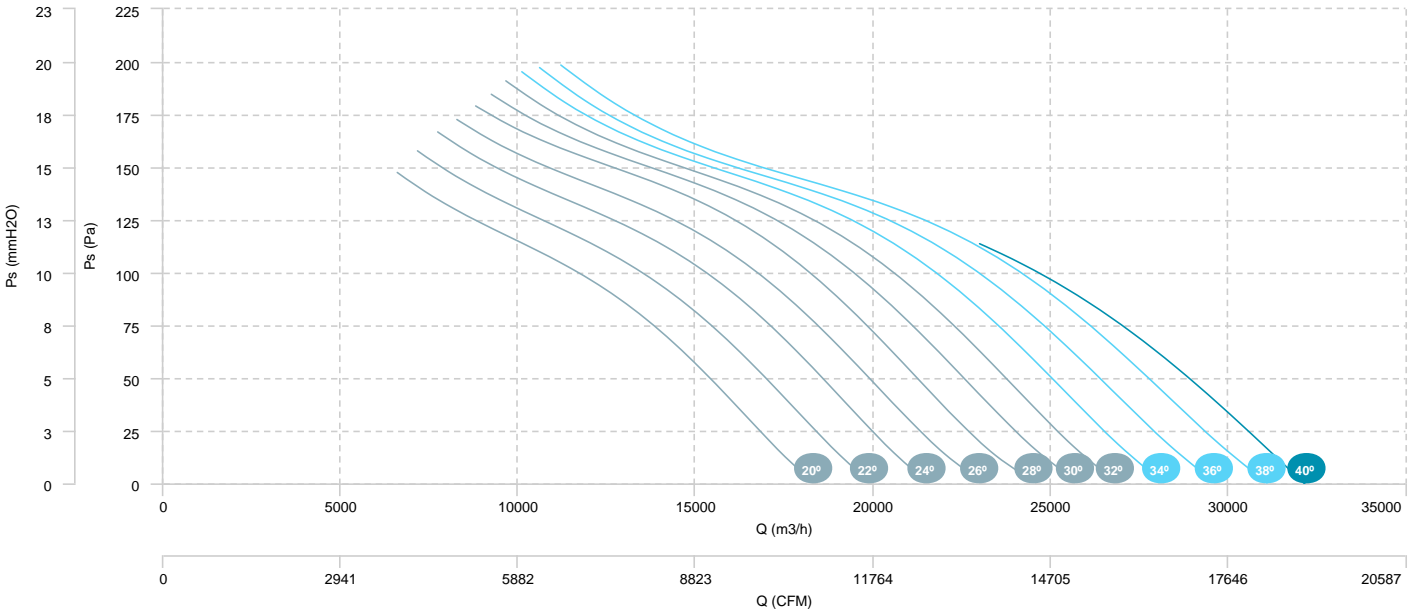

AIR FLOW - ABSORBED POWER

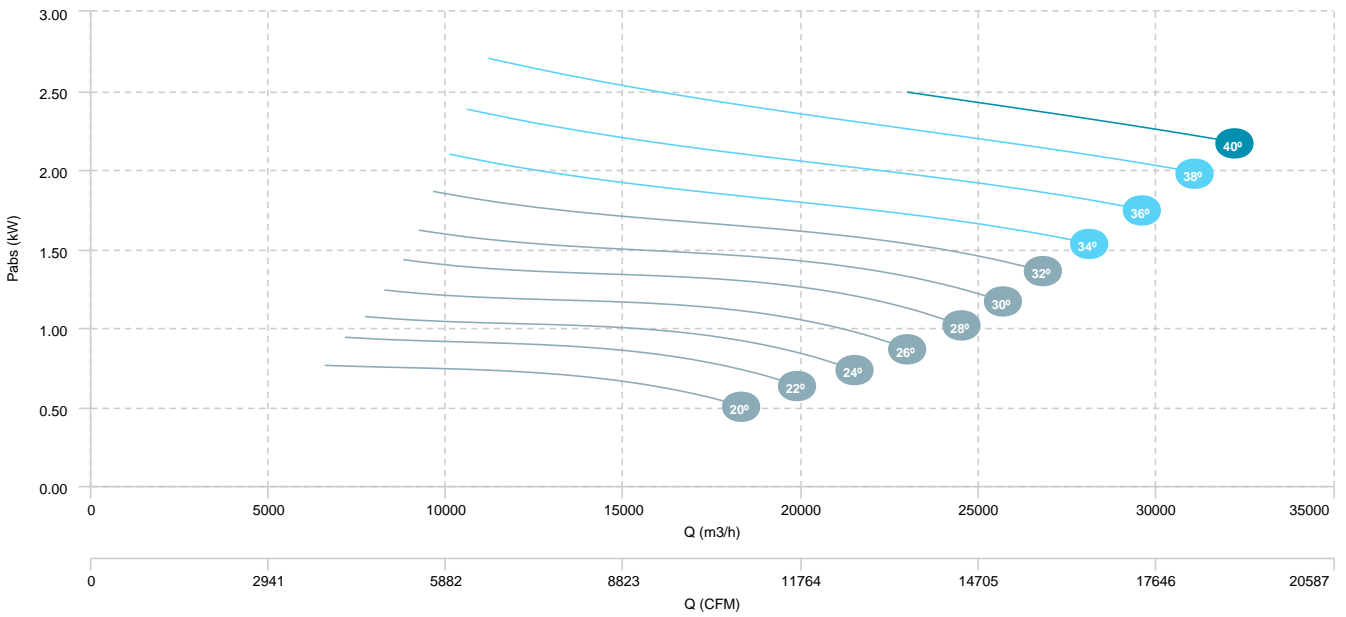

HM 90 T4/T6 5,5/1,85kW (A6:6)	HM 90 T4/T6 7,5/2,2kW (A6:6)	HM 90 T4/T6 11/3,6kW (A6:6)
HM 90 T4/T6 15/4,4kW (A6:6)		

## AIR FLOW - PRESSURE (4 poles)

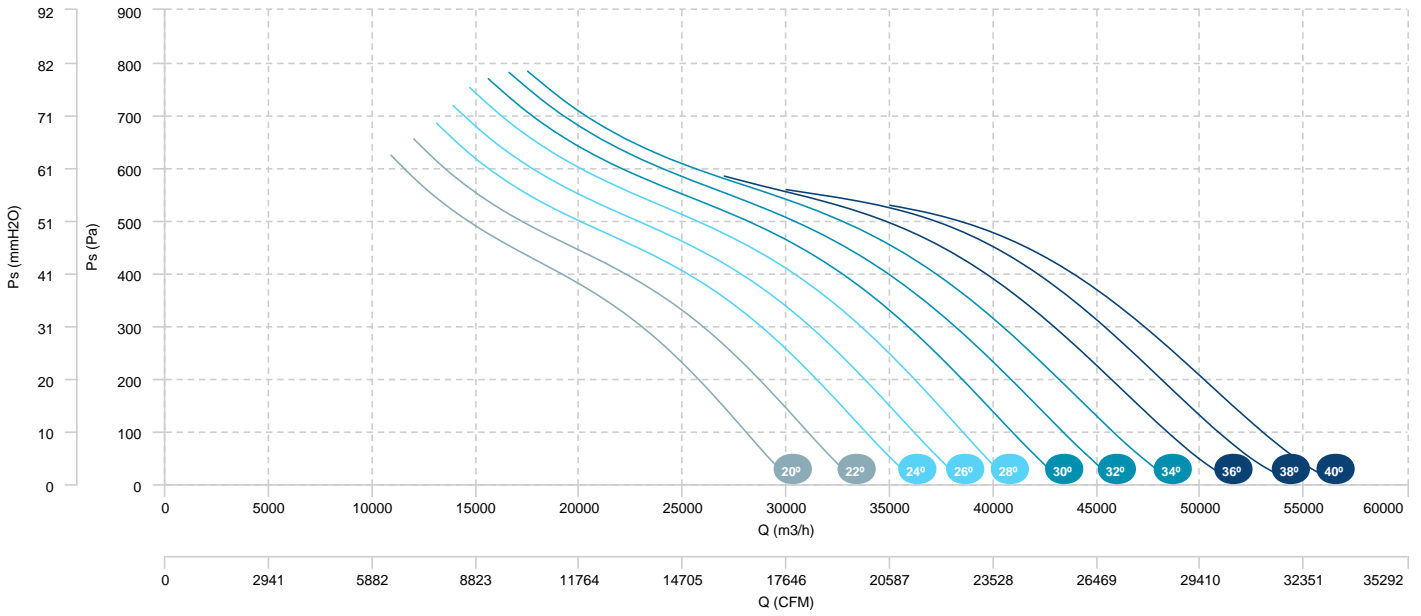

## AIR FLOW - ABSORBED POWER (4 poles)

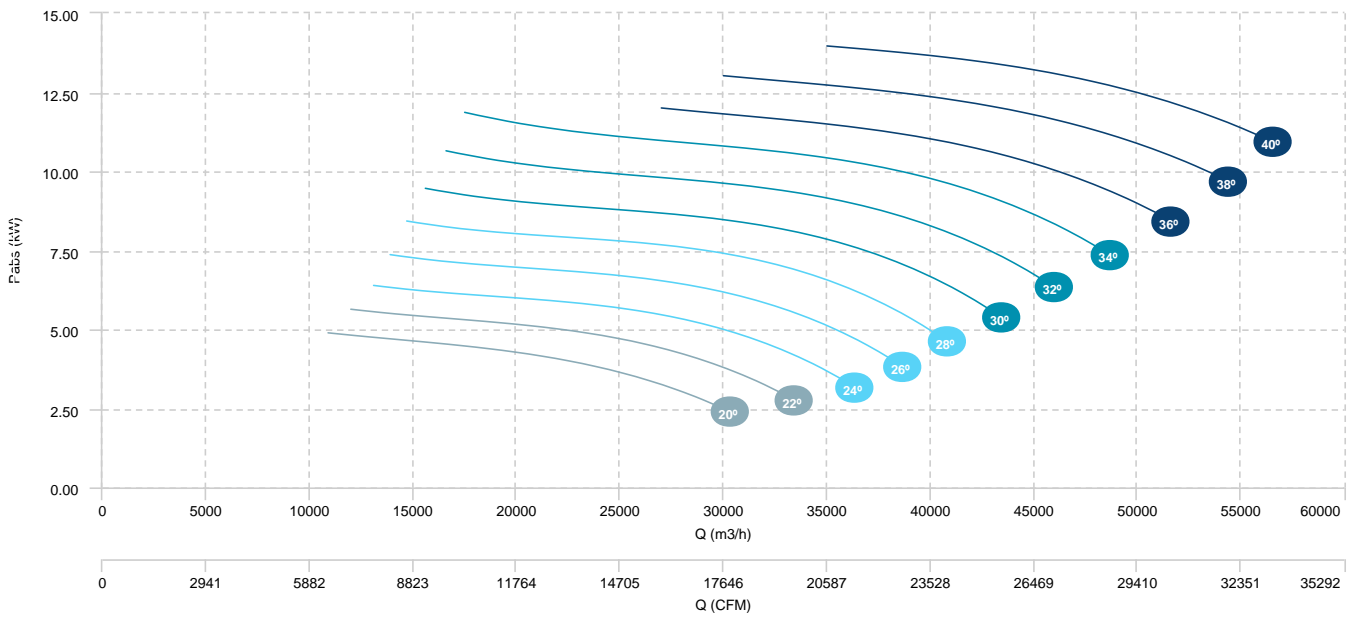



HM 90 T4/T6 5,5/1,85kW (A6:6)	HM 90 T4/T6 7,5/2,2kW (A6:6)	HM 90 T4/T6 11/3,6kW (A6:6)
HM 90 T4/T6 15/4,4kW (A6:6)		

## AIR FLOW - PRESSURE (6 poles)

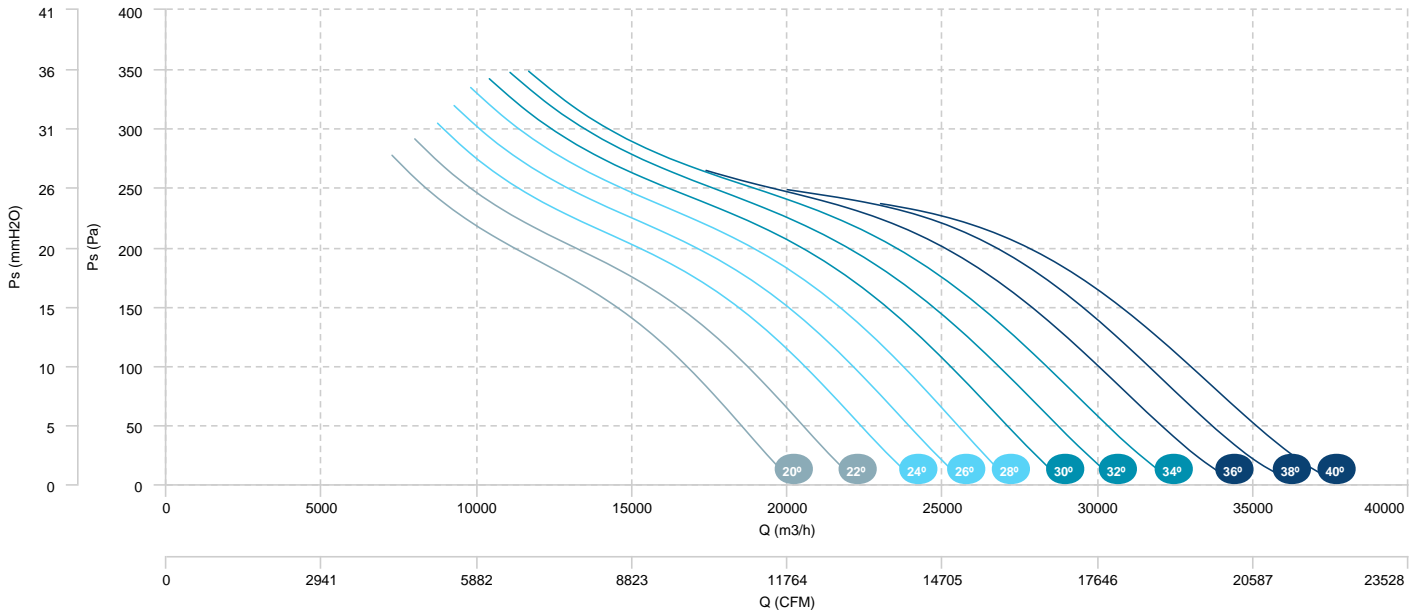

HM 90 T4/T6 3/0,9kW (A6:3)	HM 90 T4/T6 4/1,1kW (A6:3)	HM 90 T4/T6 5,5/1,85kW (A6:3)
HM 90 T4/T6 7,5/2,2kW (A6:3)	HM 90 T4/T6 11/3,6kW (A6:3)	

## AIR FLOW - PRESSURE (4 poles)

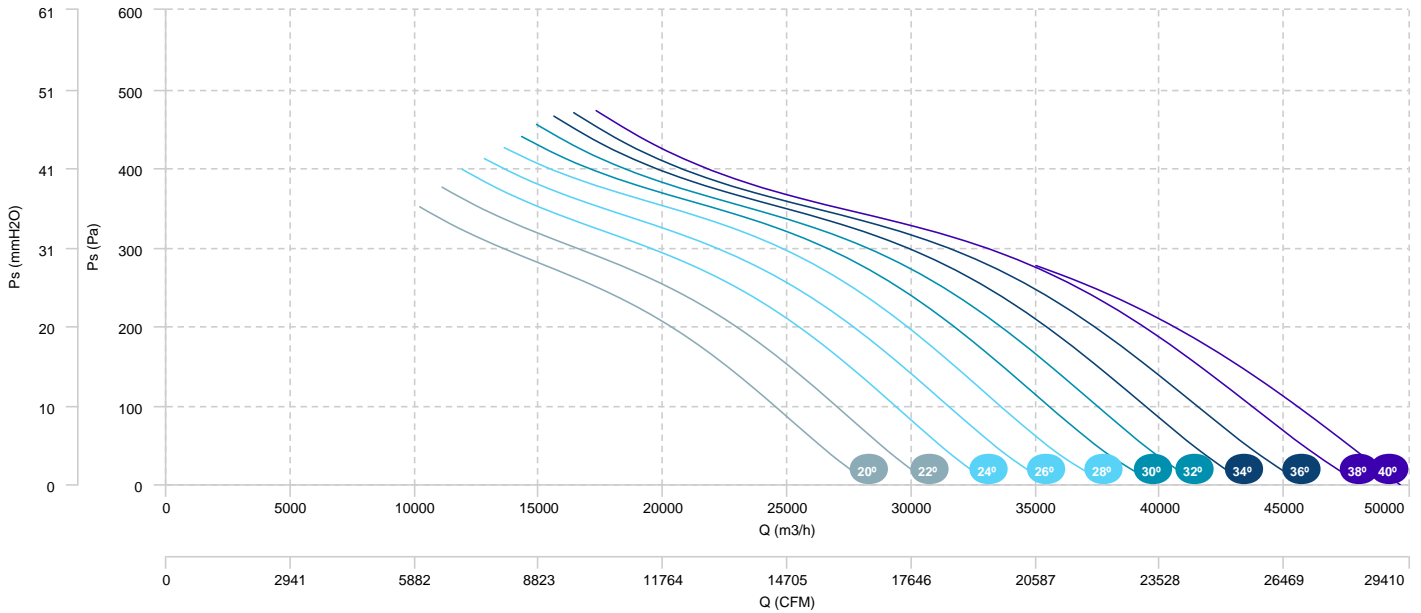

## AIR FLOW - ABSORBED POWER (4 poles)

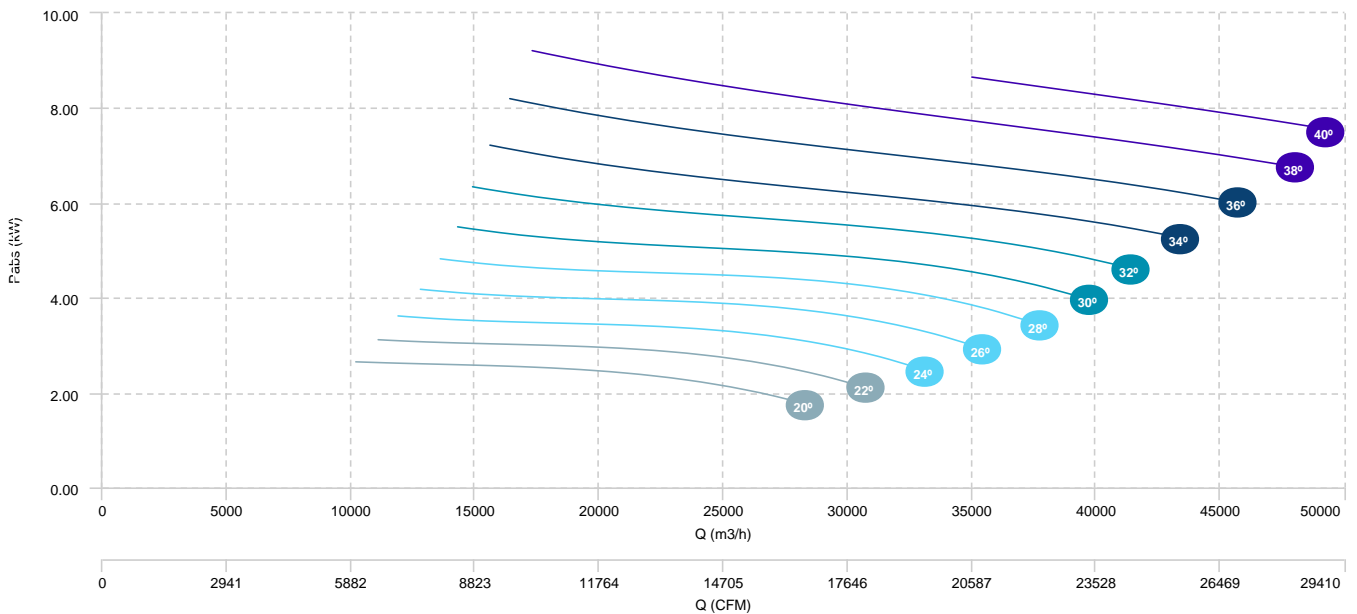

HM 90 T4/T6 3/0,9kW (A6:3)	HM 90 T4/T6 4/1,1kW (A6:3)	HM 90 T4/T6 5,5/1,85kW (A6:3)
HM 90 T4/T6 7,5/2,2kW (A6:3)	HM 90 T4/T6 11/3,6kW (A6:3)	

## AIR FLOW - PRESSURE (6 poles)

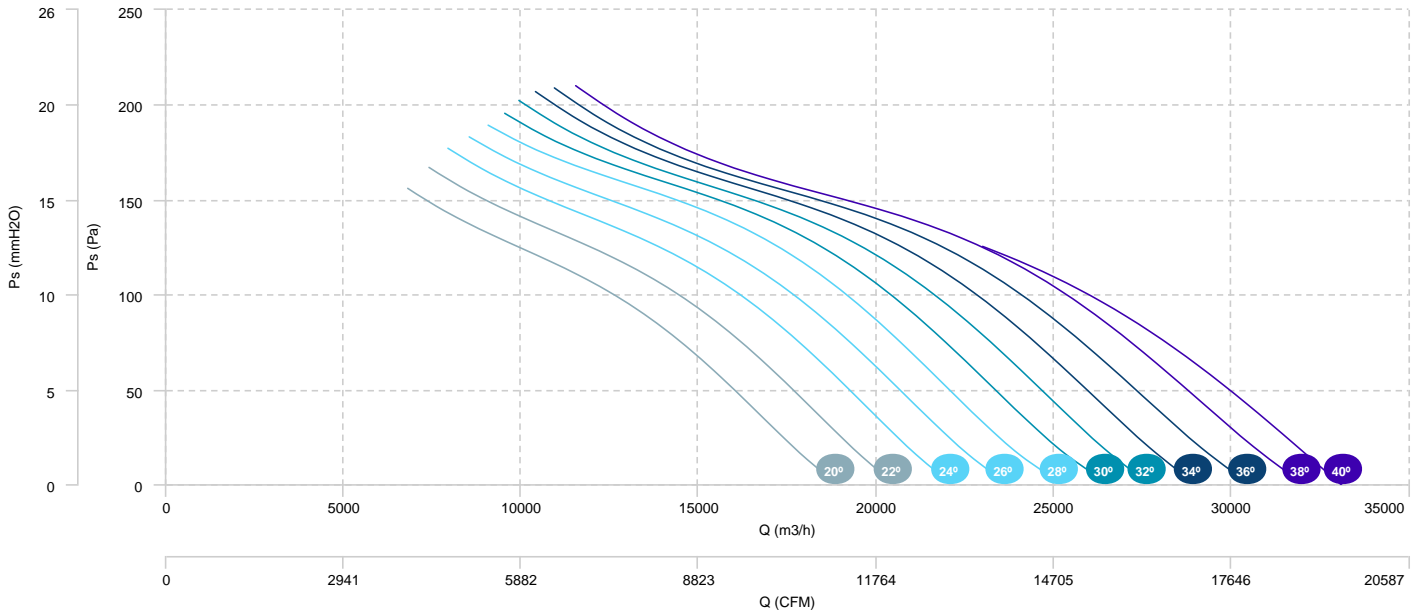

HM 90 T4/T8 3/0,55kW (A6:3)	HM 90 T4/T8 4/0,75kW (A6:3)	HM 90 T4/T8 5,5/1,1kW (A6:3)
HM 90 T4/T8 7,5/1,5kW (A6:3)	HM 90 T4/T8 11/3kW (A6:3)	

## AIR FLOW - PRESSURE (4 poles)

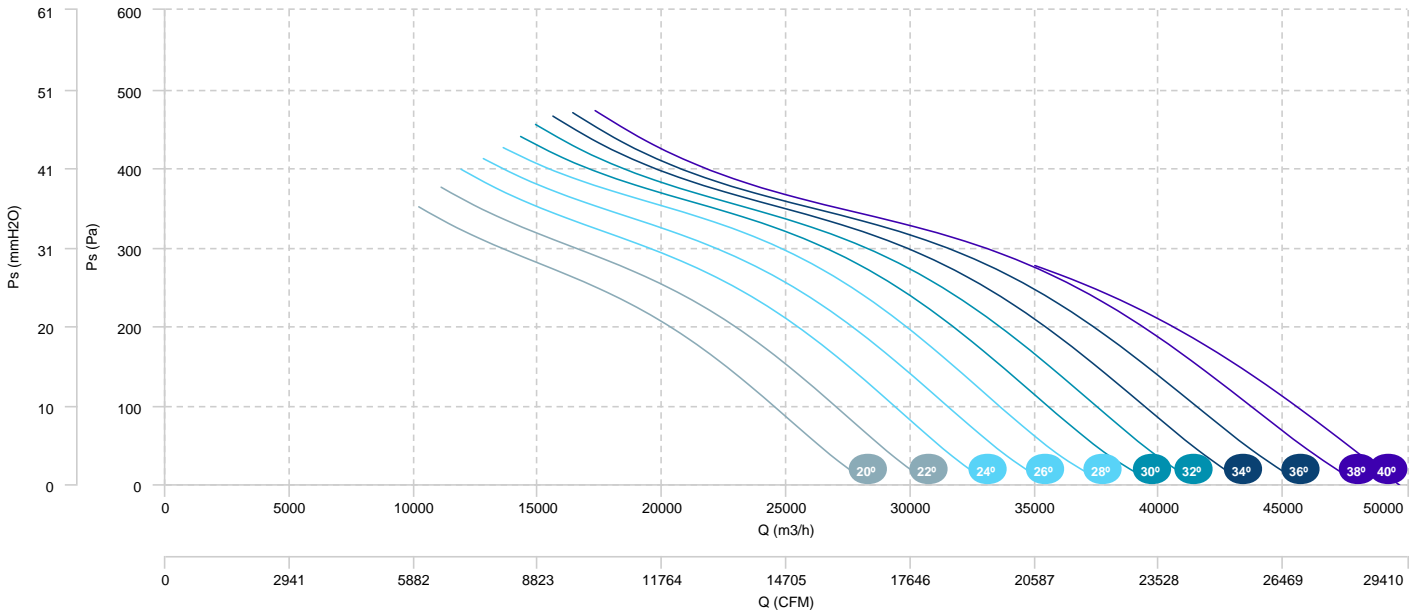

## AIR FLOW - ABSORBED POWER (4 poles)

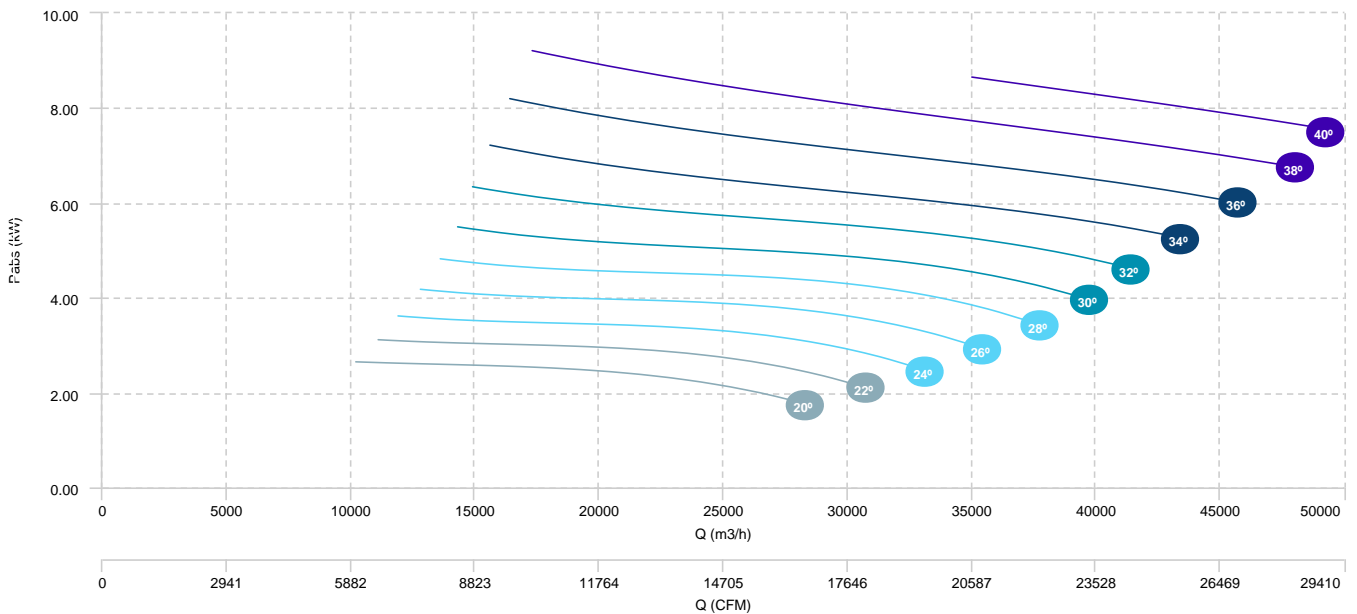

HM 90 T4/T8 3/0,55kW (A6:3)	HM 90 T4/T8 4/0,75kW (A6:3)	HM 90 T4/T8 5,5/1,1kW (A6:3)
HM 90 T4/T8 7,5/1,5kW (A6:3)	HM 90 T4/T8 11/3kW (A6:3)	

AIR FLOW - PRESSURE (8 poles)

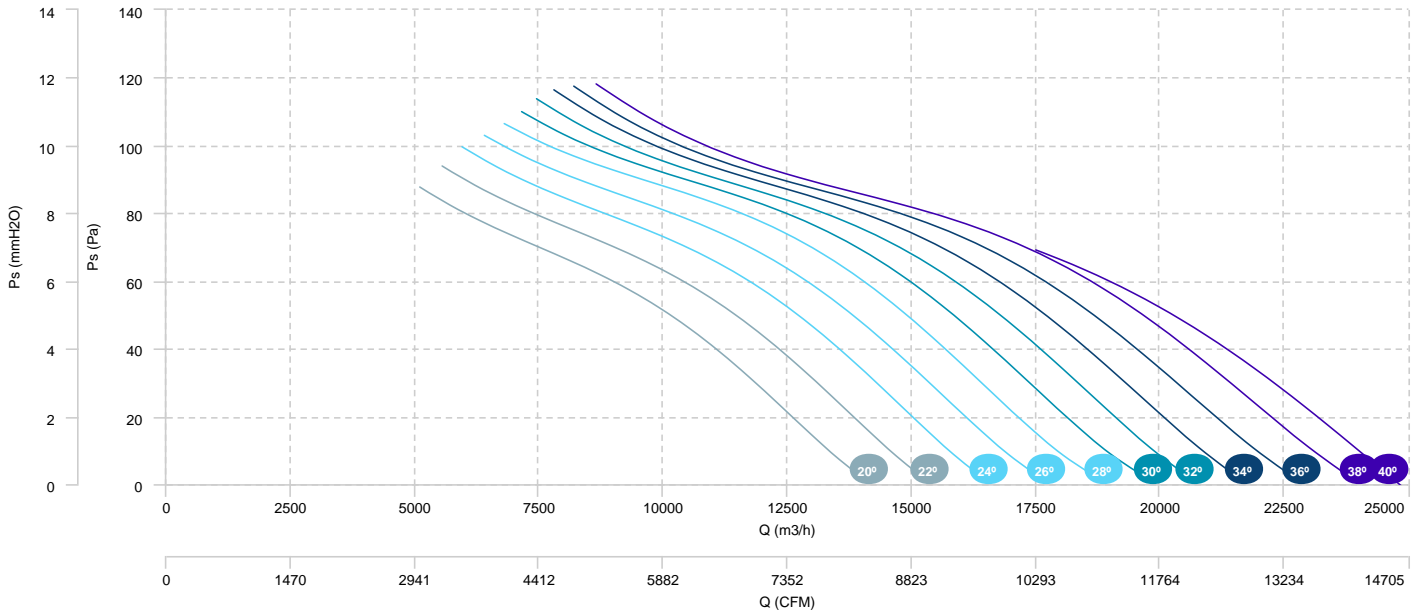

HM 90 T4/T8 5,5/1,1kW (A6:6)	HM 90 T4/T8 7,5/1,5kW (A6:6)	HM 90 T4/T8 11/3kW (A6:6)
HM 90 T4/T8 15/3,5kW (A6:6)		

## AIR FLOW - PRESSURE (4 poles)

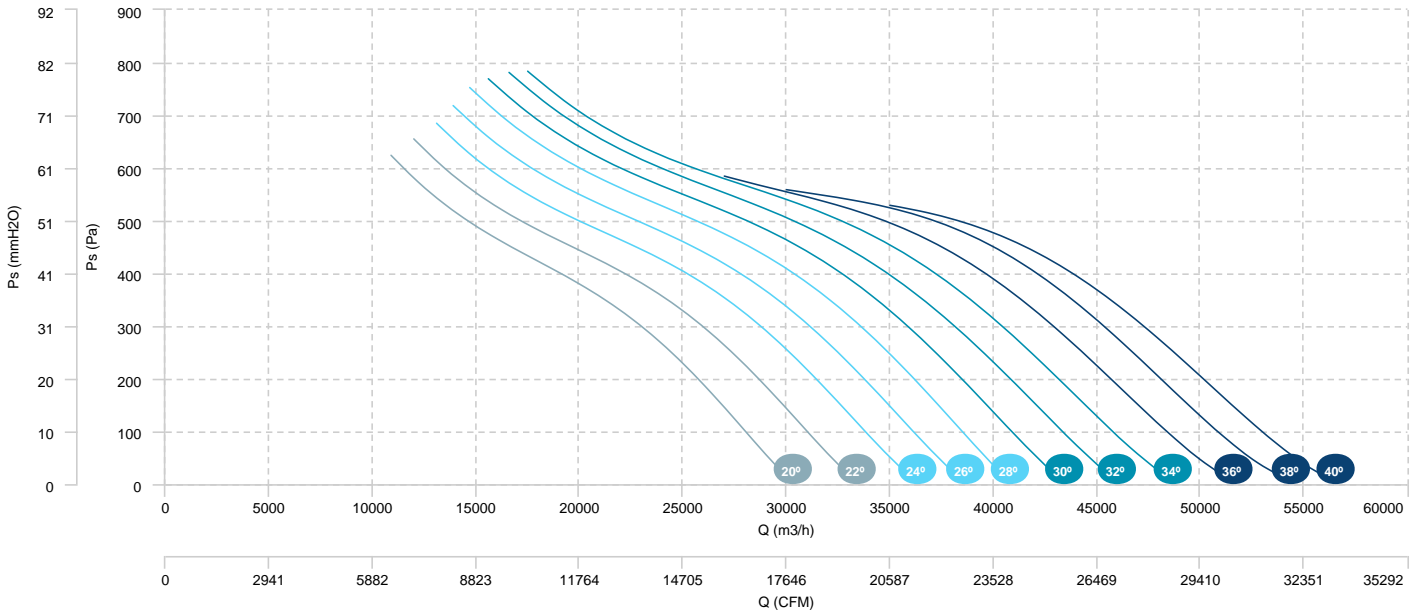

## AIR FLOW - ABSORBED POWER (4 poles)

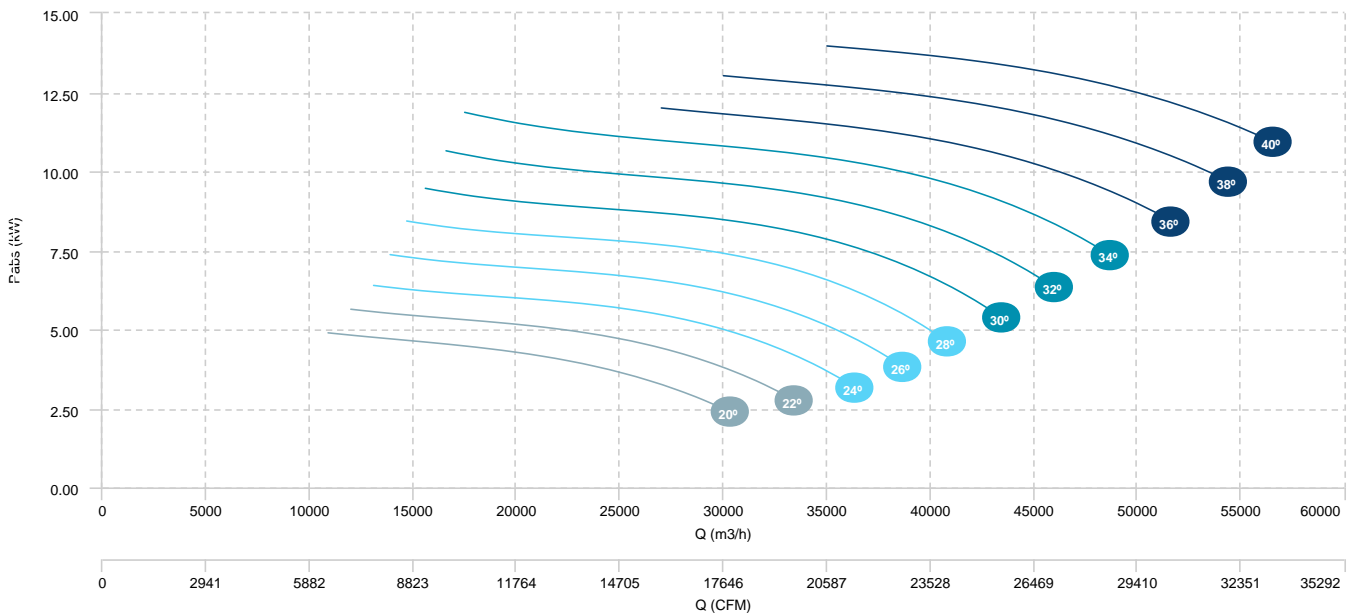

- HM 90 T4/T8 5,5/1,1kW (A6:6)
- HM 90 T4/T8 7,5/1,5kW (A6:6)
- HM 90 T4/T8 11/3kW (A6:6)
- HM 90 T4/T8 15/3,5kW (A6:6)

## AIR FLOW - PRESSURE (8 poles)

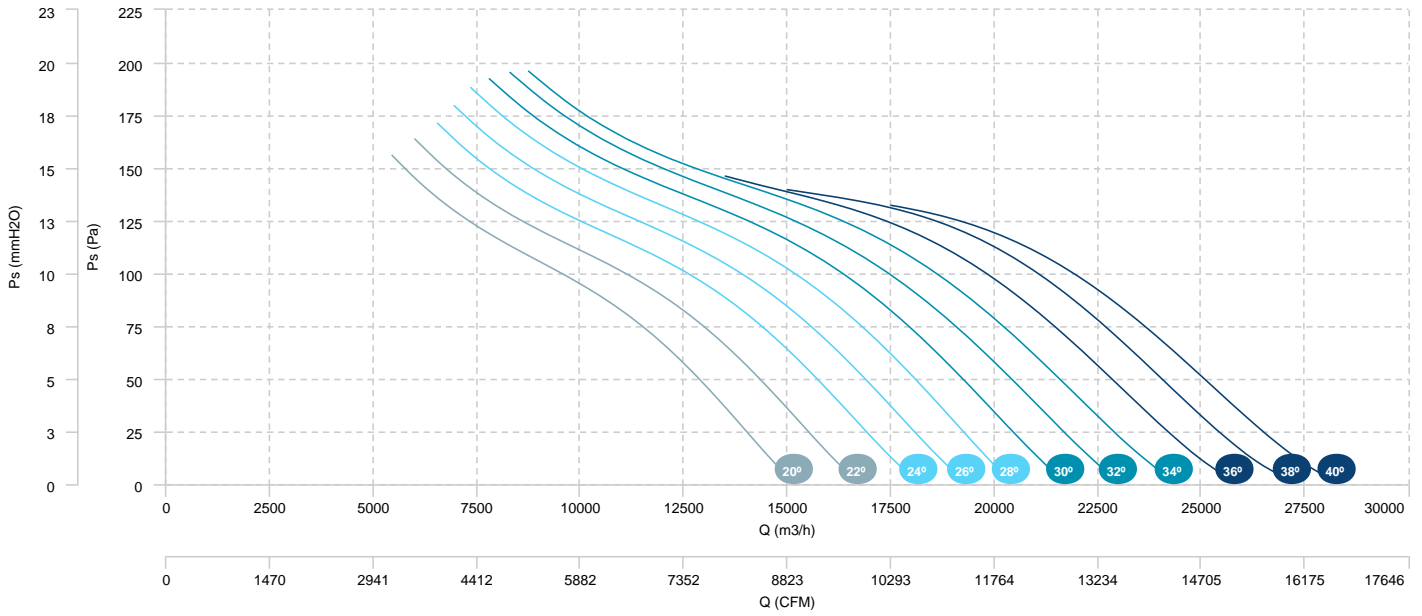

HM 100 T4 7,5kW (A6:6)	HM 100 T4 11kW (A6:6)	HM 100 T4 15kW (A6:6)
HM 100 T4 18,5kW (A6:6)	HM 100 T4 22kW (A6:6)	

## AIR FLOW - PRESSURE

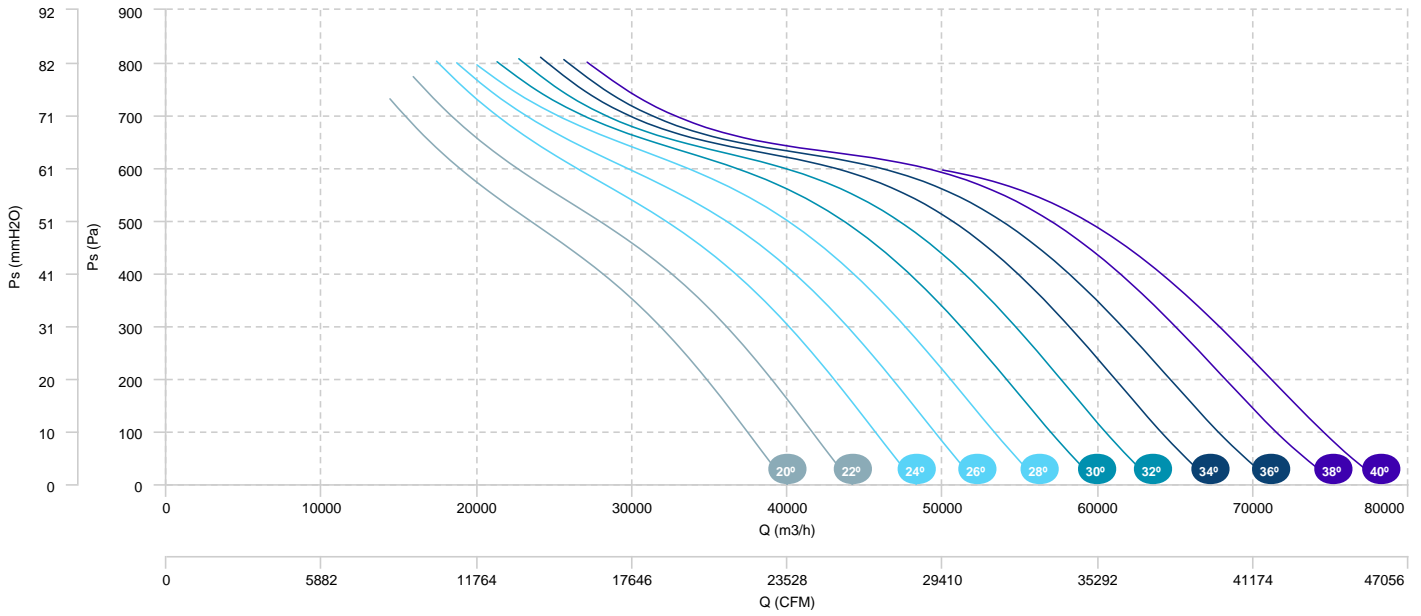

## AIR FLOW - ABSORBED POWER

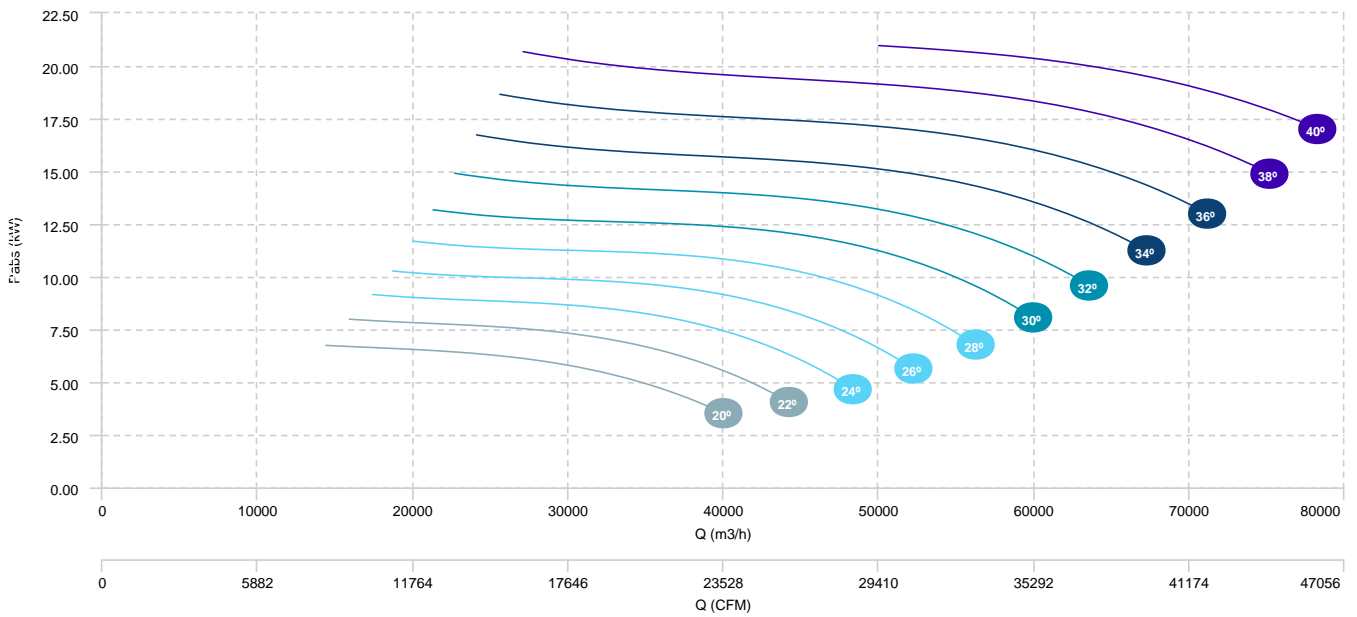



HM 100 T4 5,5kW (A6:3)	HM 100 T4 7,5kW (A6:3)	HM 100 T4 11kW (A6:3)
HM 100 T4 15kW (A6:3)		

## AIR FLOW - PRESSURE

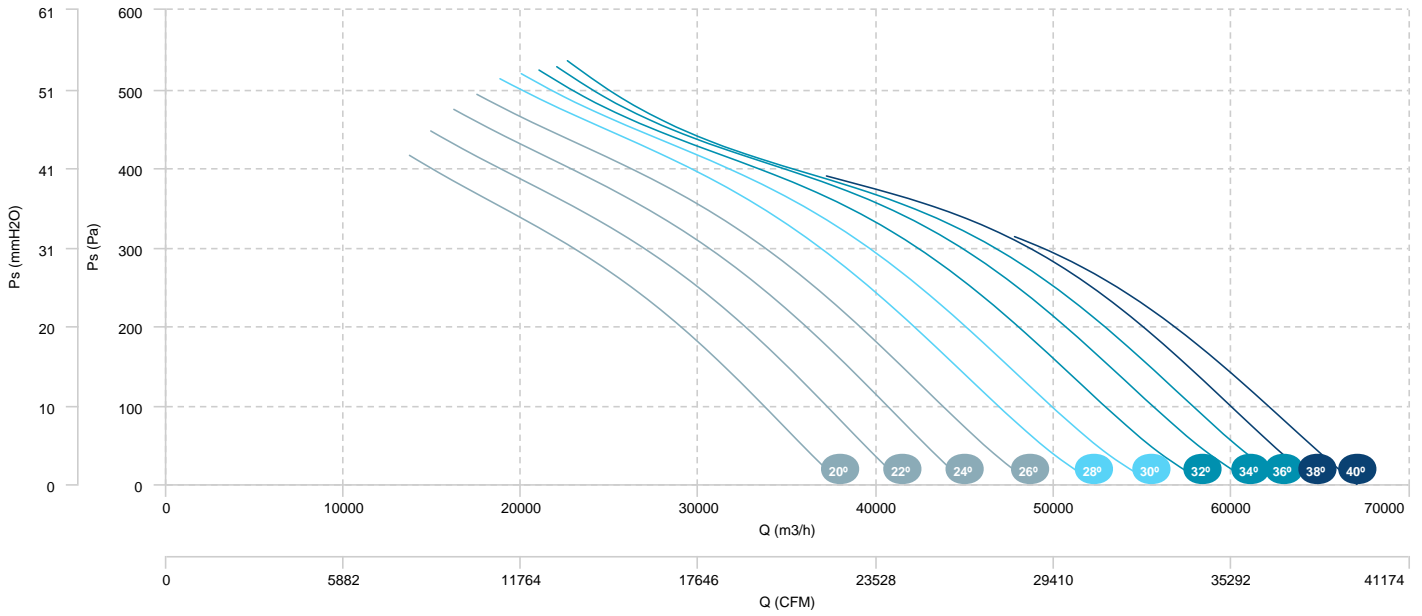

## AIR FLOW - ABSORBED POWER

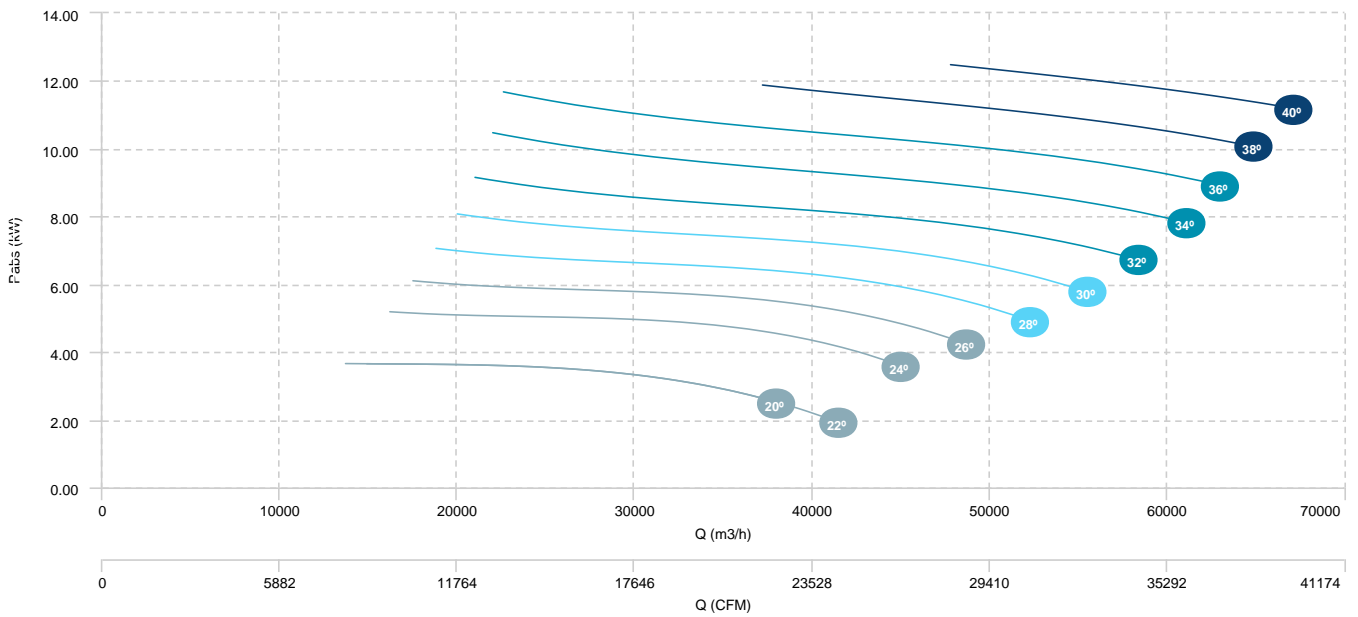

HM 100 T6 2,2kW (A6:6)	HM 100 T6 3kW (A6:6)	HM 100 T6 4kW (A6:6)
HM 100 T6 5,5kW (A6:6)	HM 100 T6 7,5kW (A6:6)	

## AIR FLOW - PRESSURE

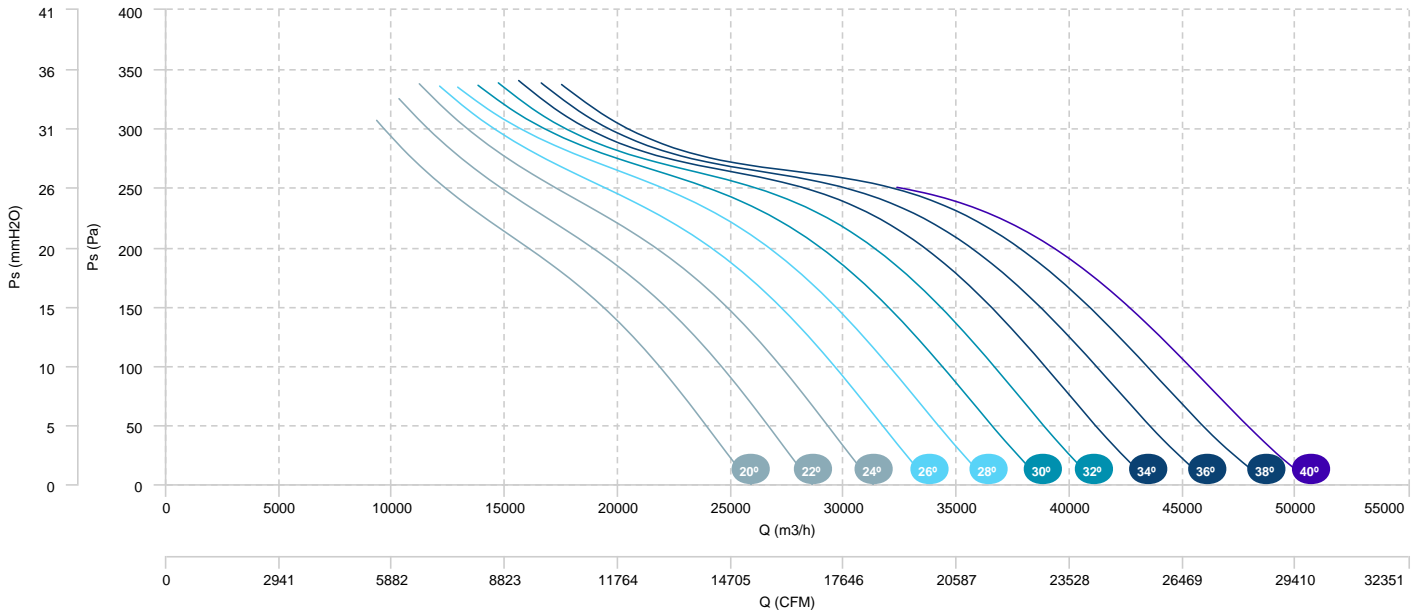

## AIR FLOW - ABSORBED POWER

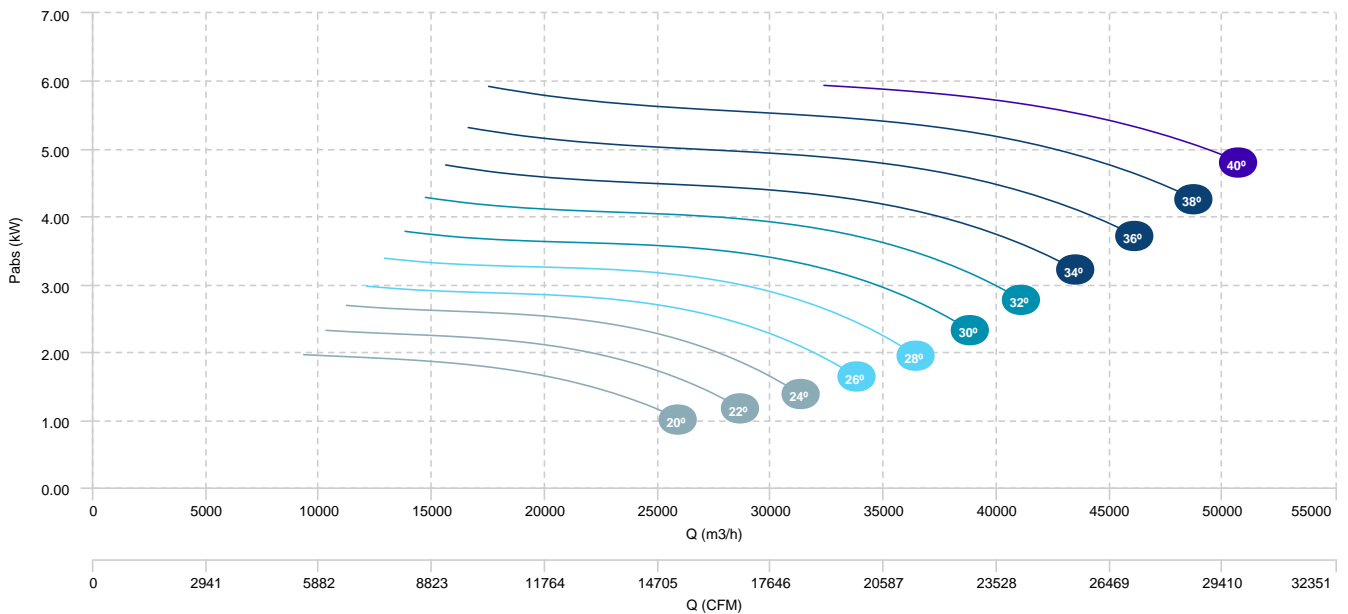

HM 100 T6 1,5kW (A6:3)	HM 100 T6 2,2kW (A6:3)	HM 100 T6 3kW (A6:3)
HM 100 T6 4kW (A6:3)		

## AIR FLOW - PRESSURE

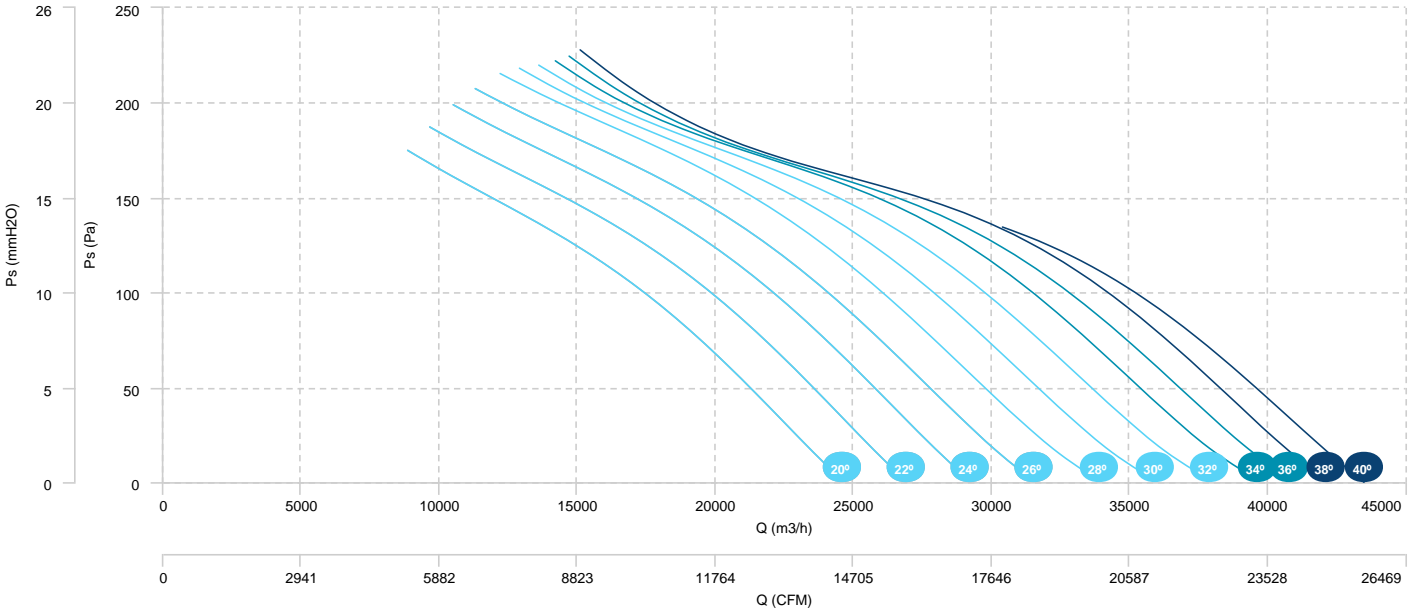

## AIR FLOW - ABSORBED POWER

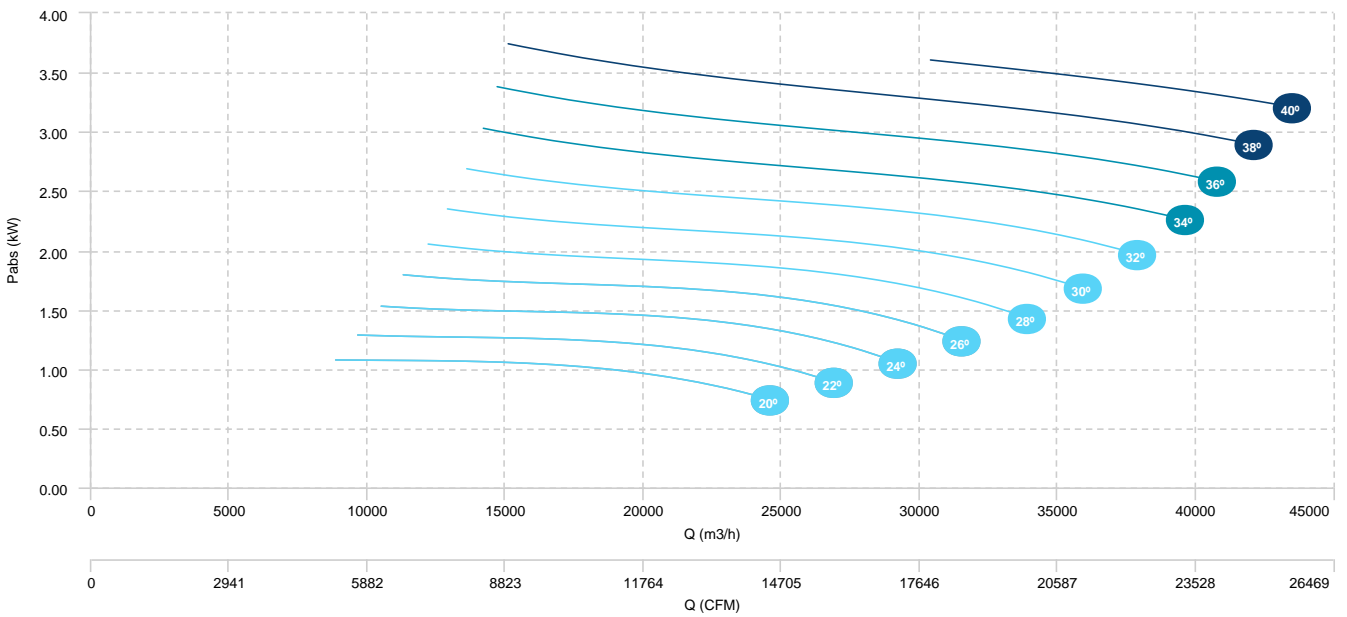

HM 100 T4/T6 7,5/2,2kW (A6:6)	HM 100 T4/T6 11,3,6kW (A6:6)	HM 100 T4/T6 15/4,4kW (A6:6)
HM 100 T4/T6 18,5/6kW (A6:6)	HM 100 T4/T6 22/7,5kW (A6:6)	

## AIR FLOW - PRESSURE (4 poles)

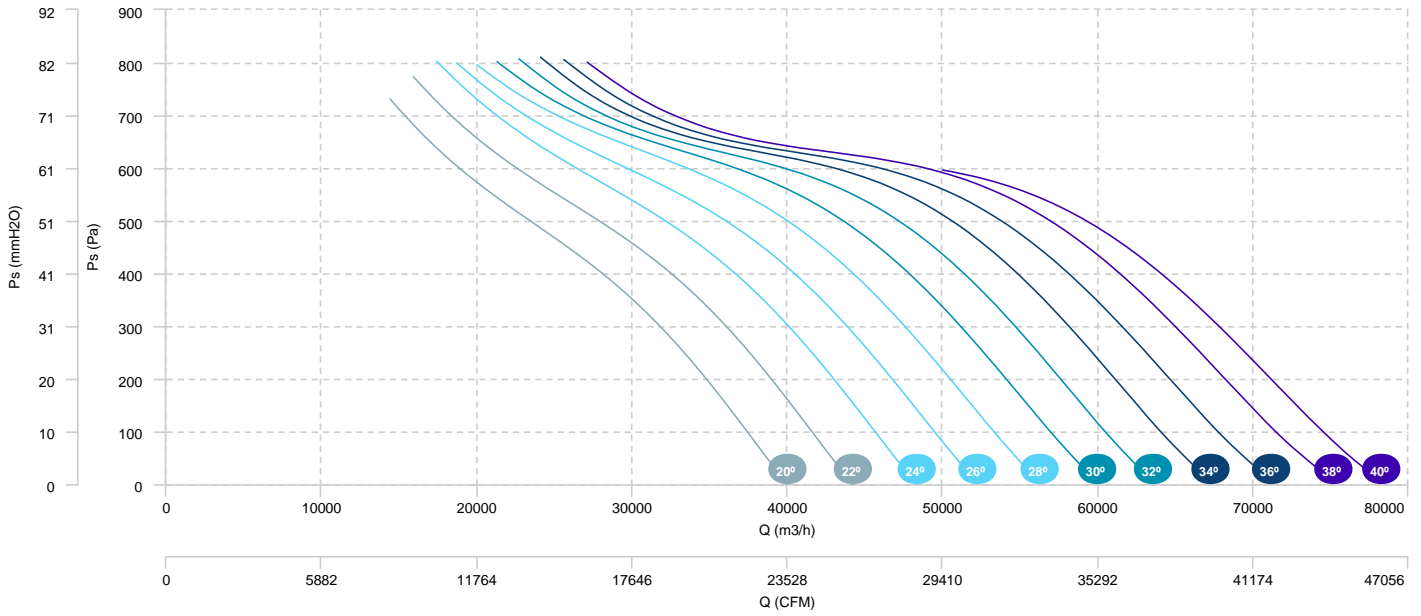

## AIR FLOW - ABSORBED POWER (4 poles)

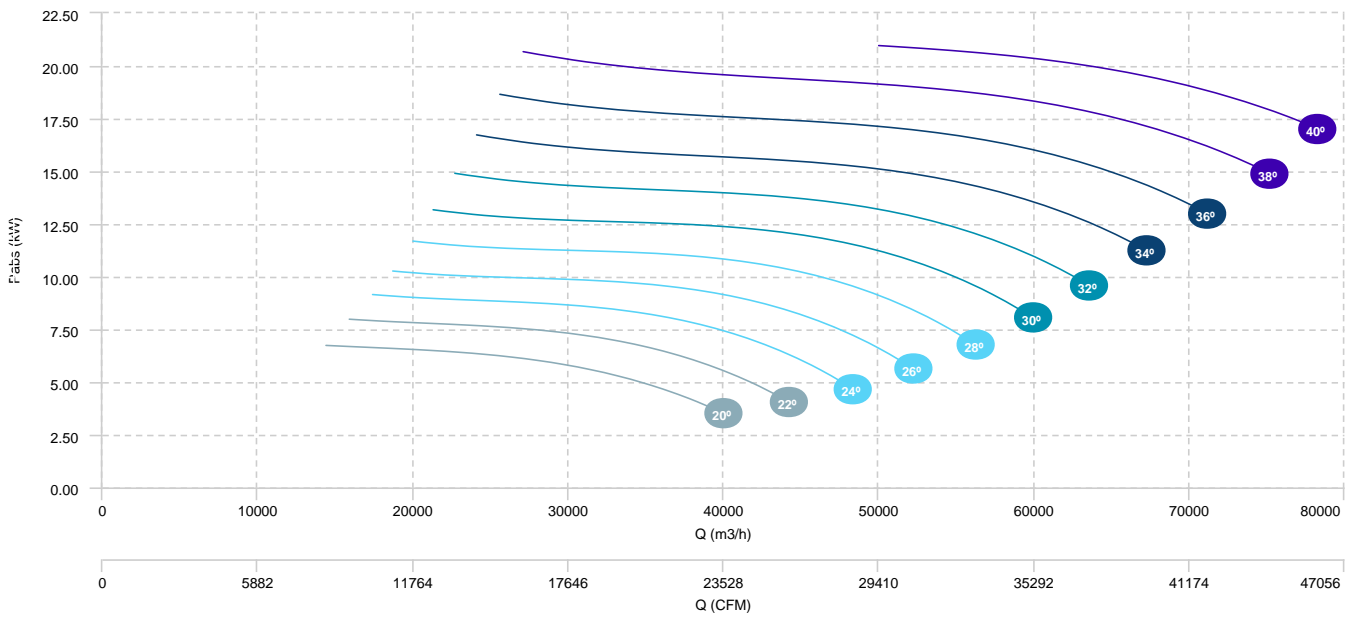

HM 100 T4/T6 7,5/2,2kW (A6:6)	HM 100 T4/T6 11/3,6kW (A6:6)	HM 100 T4/T6 15/4,4kW (A6:6)
HM 100 T4/T6 18,5/6kW (A6:6)	HM 100 T4/T6 22/7,5kW (A6:6)	

AIR FLOW - PRESSURE (6 poles)

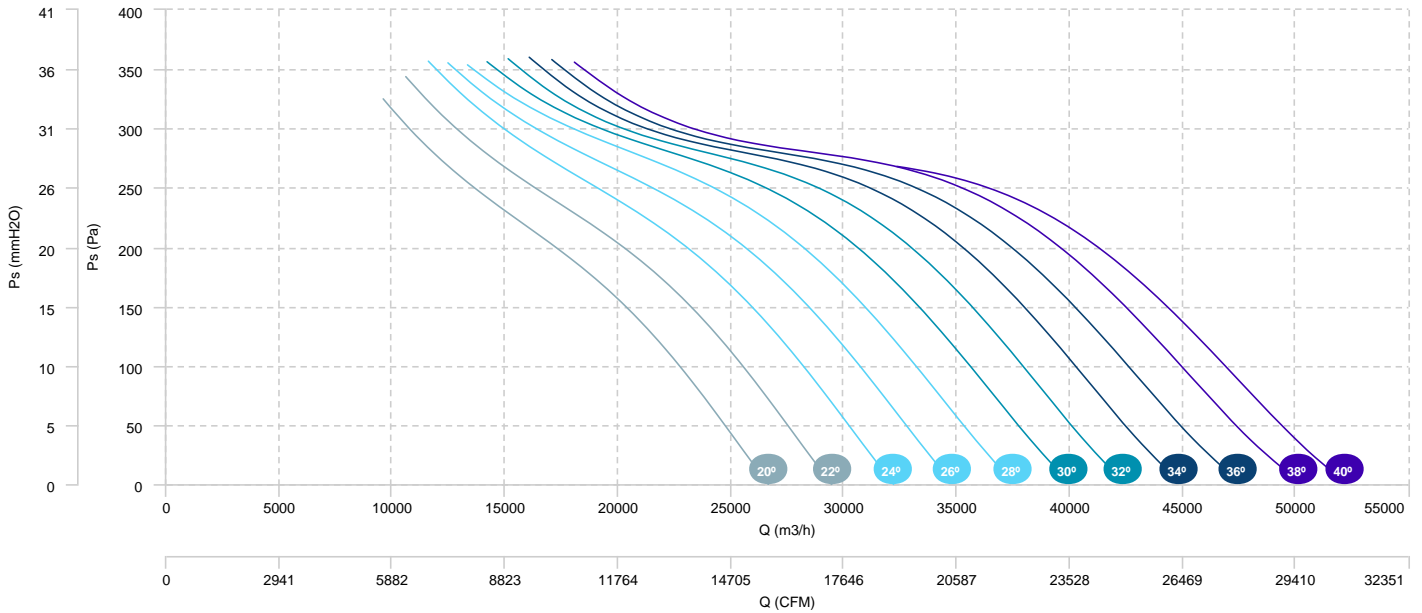

HM 100 T4/T6 5,5/1,85kW (A6:3)	HM 100 T4/T6 7,5/2,2kW (A6:3)	HM 100 T4/T6 11/3,6kW (A6:3)
HM 100 T4/T6 15/4,4kW (A6:3)		

## AIR FLOW - PRESSURE (4 poles)

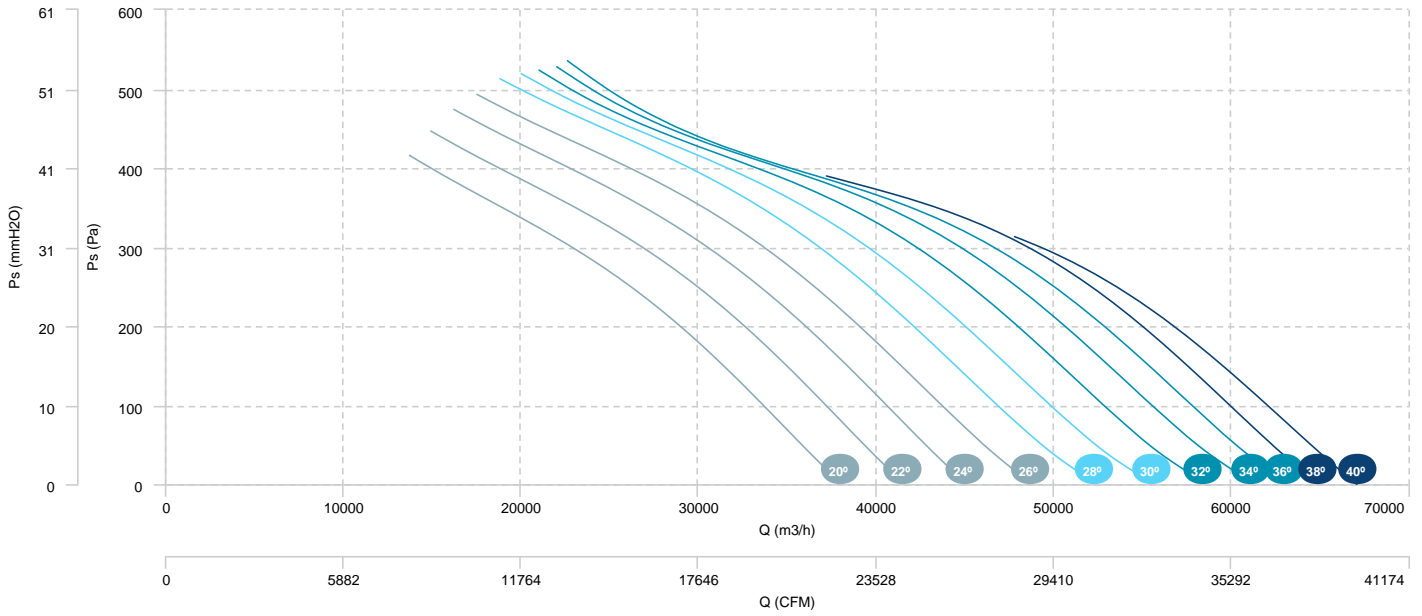

## AIR FLOW - ABSORBED POWER (4 poles)

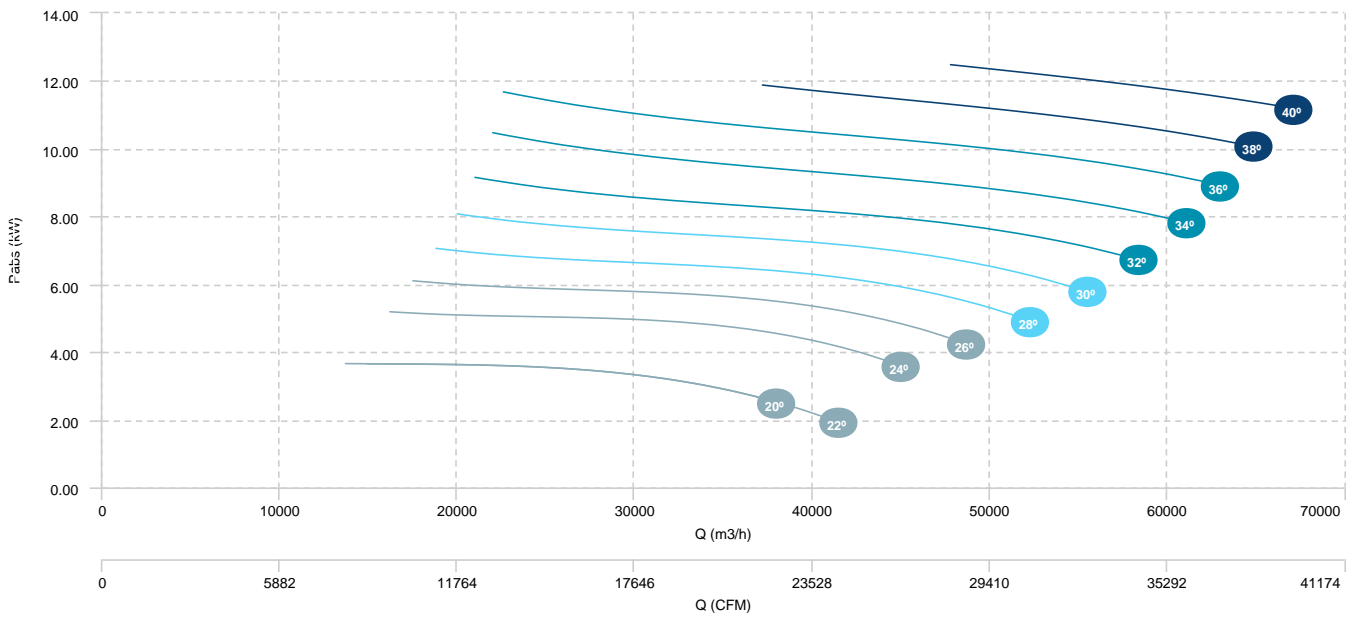

HM 100 T4/T6 5,5/1,85kW (A6:3)  
 HM 100 T4/T6 15/4,4kW (A6:3)

HM 100 T4/T6 7,5/2,2kW (A6:3)

HM 100 T4/T6 11/3,6kW (A6:3)

## AIR FLOW - PRESSURE (6 poles)

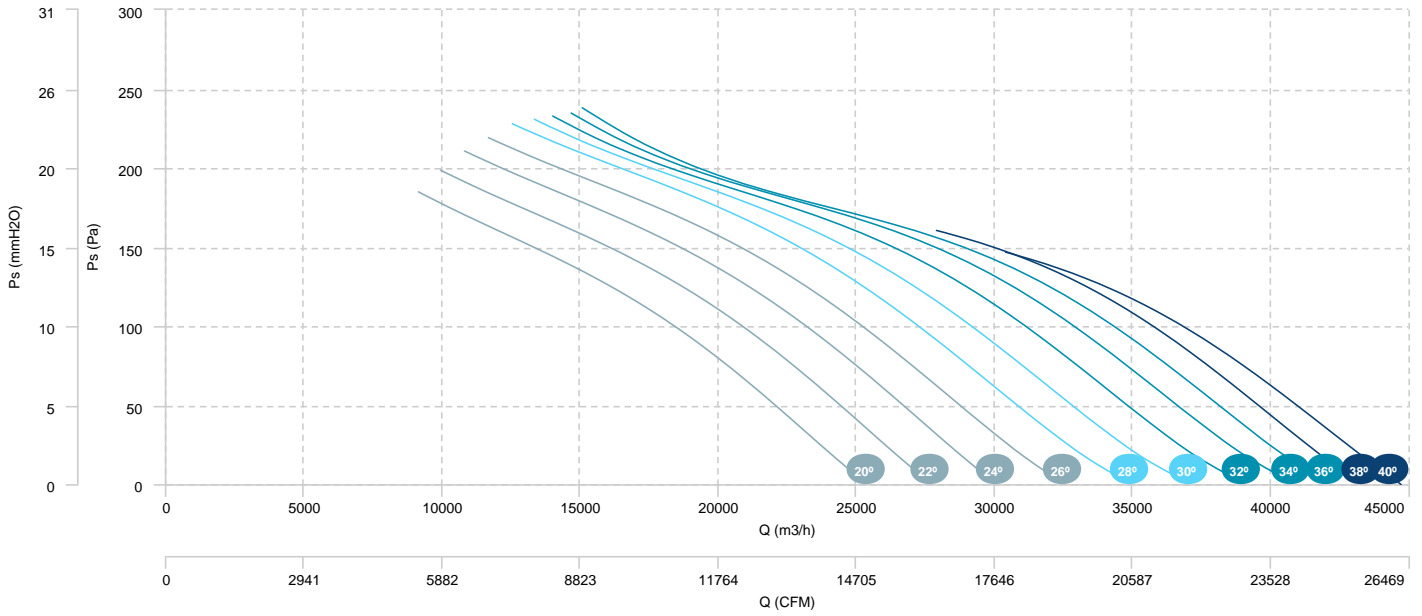

HM 100 T4/T8 7,5/1,5kW (A6:6)	HM 100 T4/T8 11/3kW (A6:6)	HM 100 T4/T8 15/3,5kW (A6:6)
HM 100 T4/T8 17/4,3kW (A6:6)	HM 100 T4/T8 20/5kW (A6:6)	

## AIR FLOW - PRESSURE (4 poles)

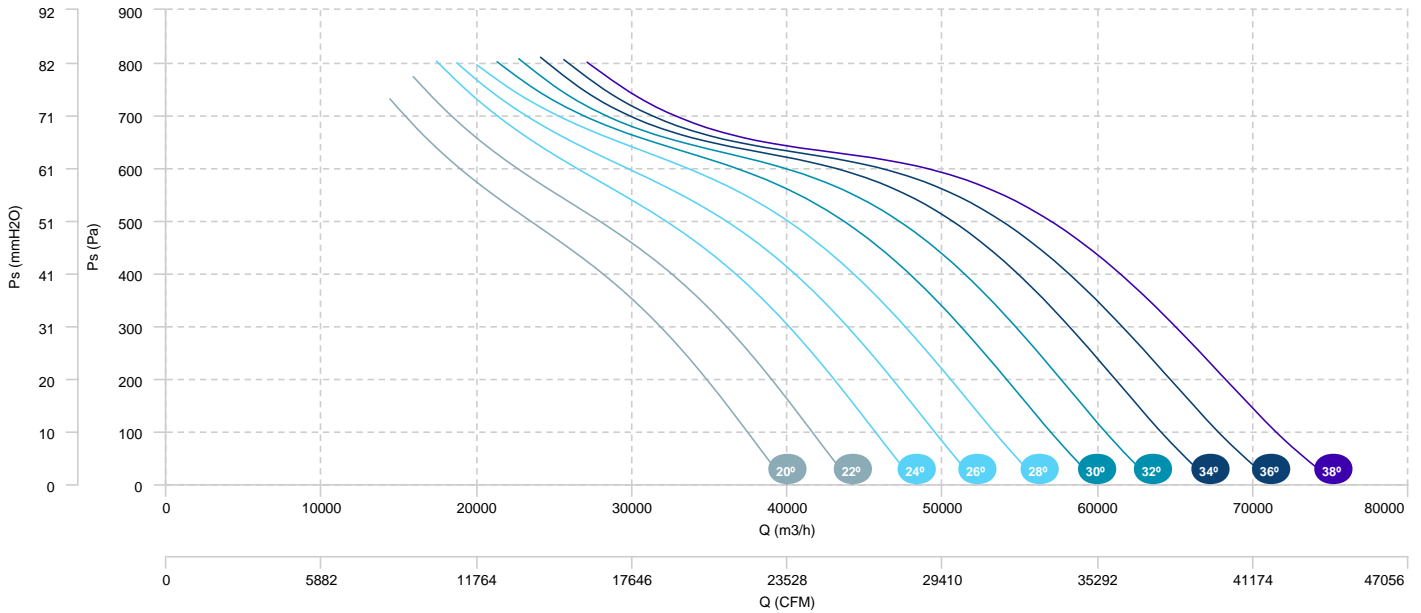

## AIR FLOW - ABSORBED POWER (4 poles)

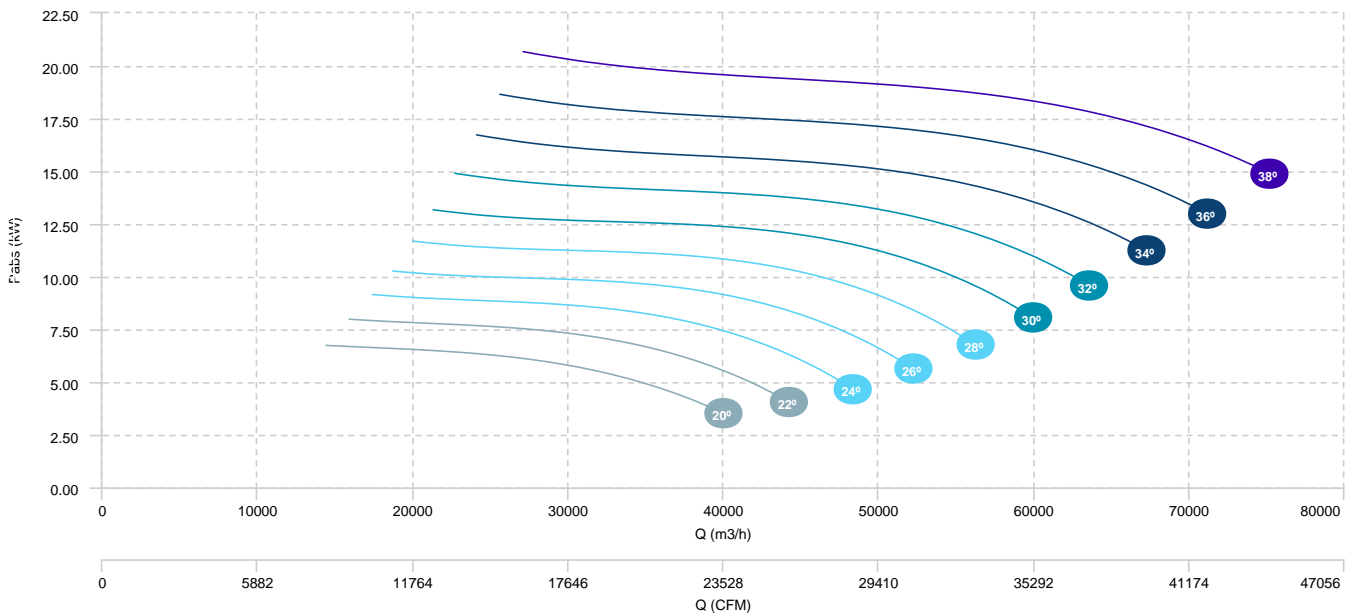



HM 100 T4/T8 7,5/1,5kW (A6:6)	HM 100 T4/T8 11/3kW (A6:6)	HM 100 T4/T8 15/3,5kW (A6:6)
HM 100 T4/T8 17/4,3kW (A6:6)	HM 100 T4/T8 20/5kW (A6:6)	

**AIR FLOW - PRESSURE (8 poles)**

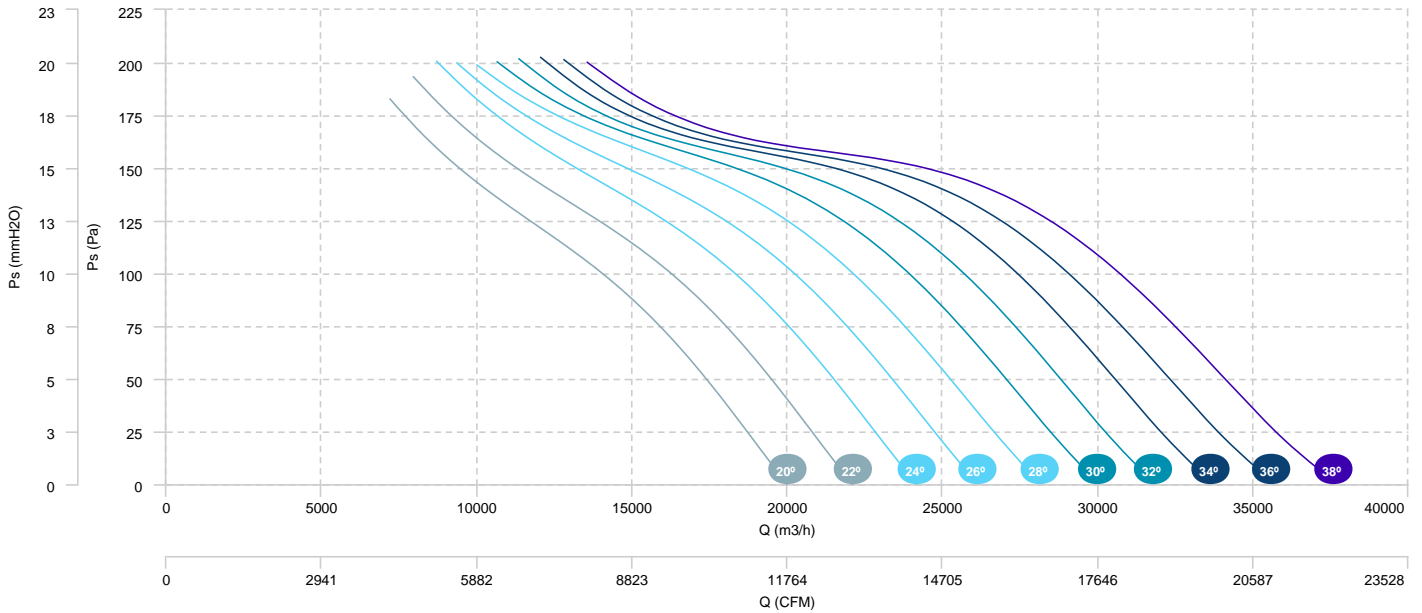

HM 100 T4/T8 5,5/1,1kW (A6:3)  
 HM 100 T4/T8 15/3,5kW (A6:3)

HM 100 T4/T8 7,5/1,5kW (A6:3)

HM 100 T4/T8 11/3kW (A6:3)

AIR FLOW - PRESSURE (4 poles)

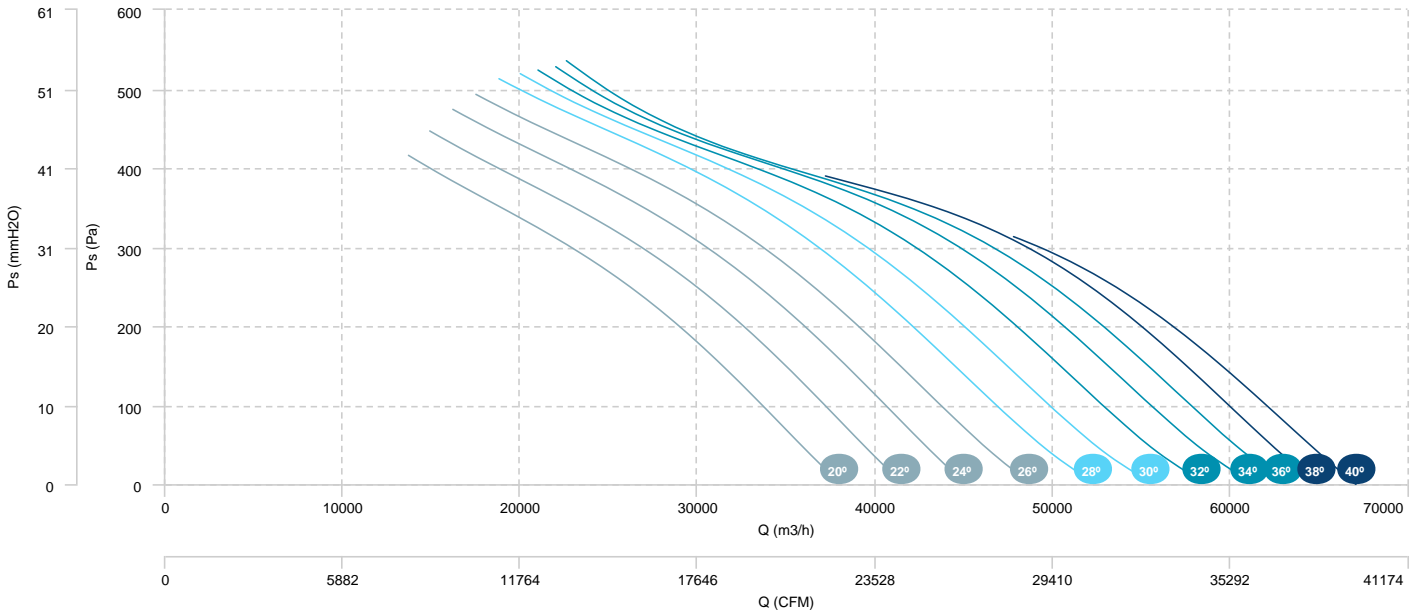

AIR FLOW - ABSORBED POWER (4 poles)

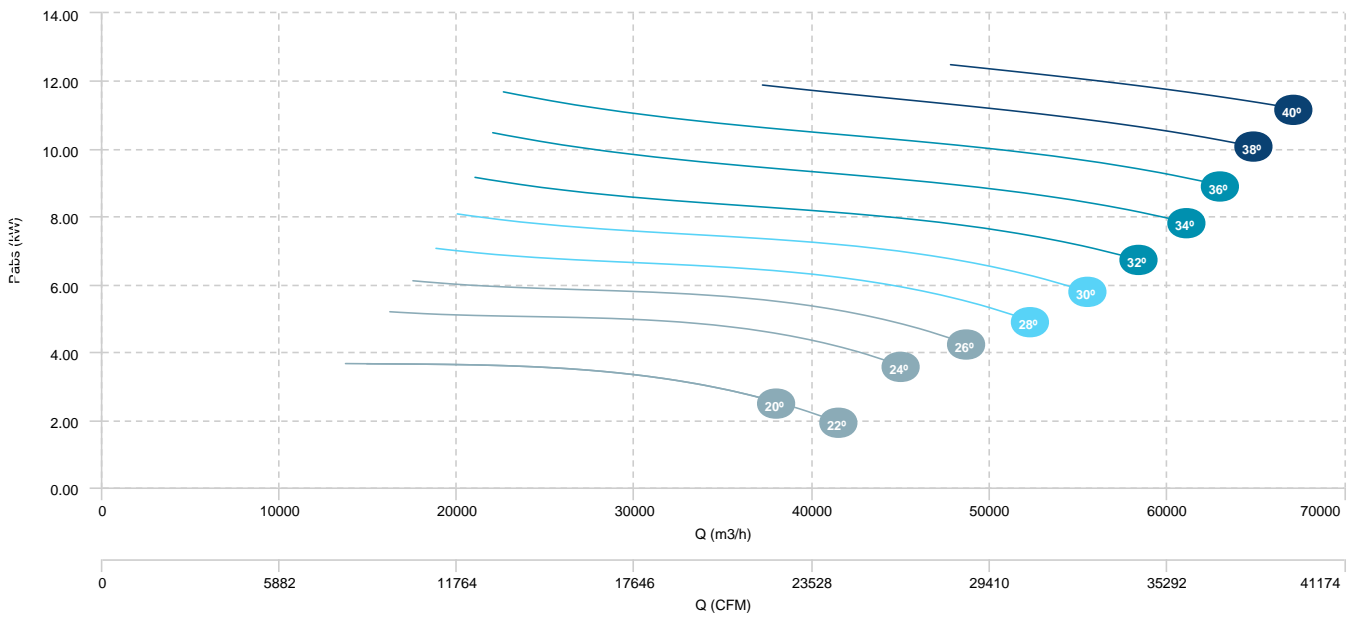

HM 100 T4/T8 5,5/1,1kW (A6:3)	HM 100 T4/T8 7,5/1,5kW (A6:3)	HM 100 T4/T8 11/3kW (A6:3)
HM 100 T4/T8 15/3,5kW (A6:3)		

AIR FLOW - PRESSURE (8 poles)

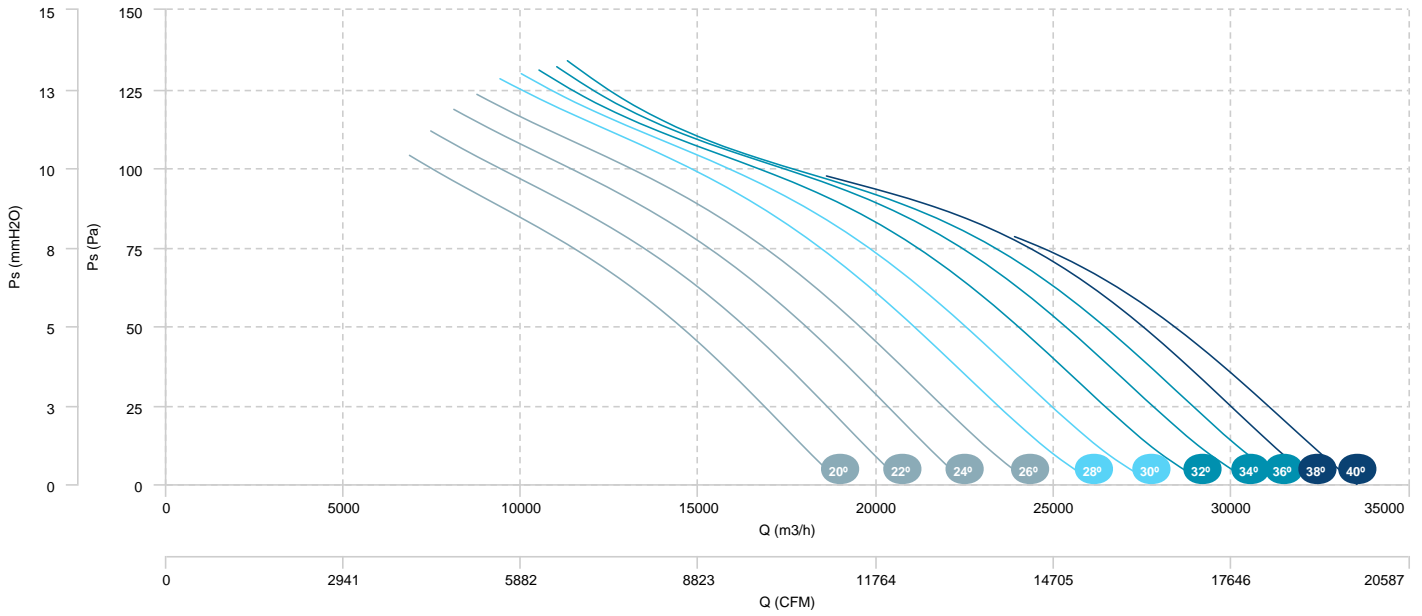

HM 112 T4 11kW (A6:6)	HM 112 T4 15kW (A6:6)	HM 112 T4 18,5kW (A6:6)
HM 112 T4 22kW (A6:6)	HM 112 T4 30kW (A6:6)	

## AIR FLOW - PRESSURE

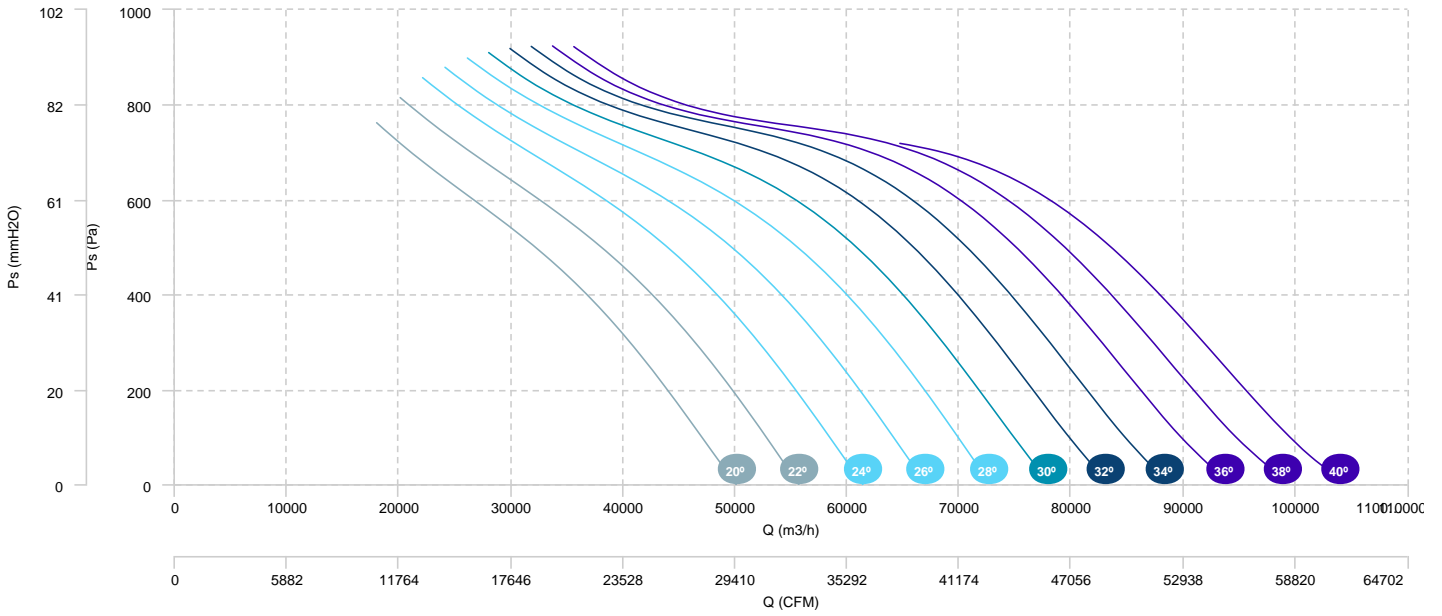

## AIR FLOW - ABSORBED POWER

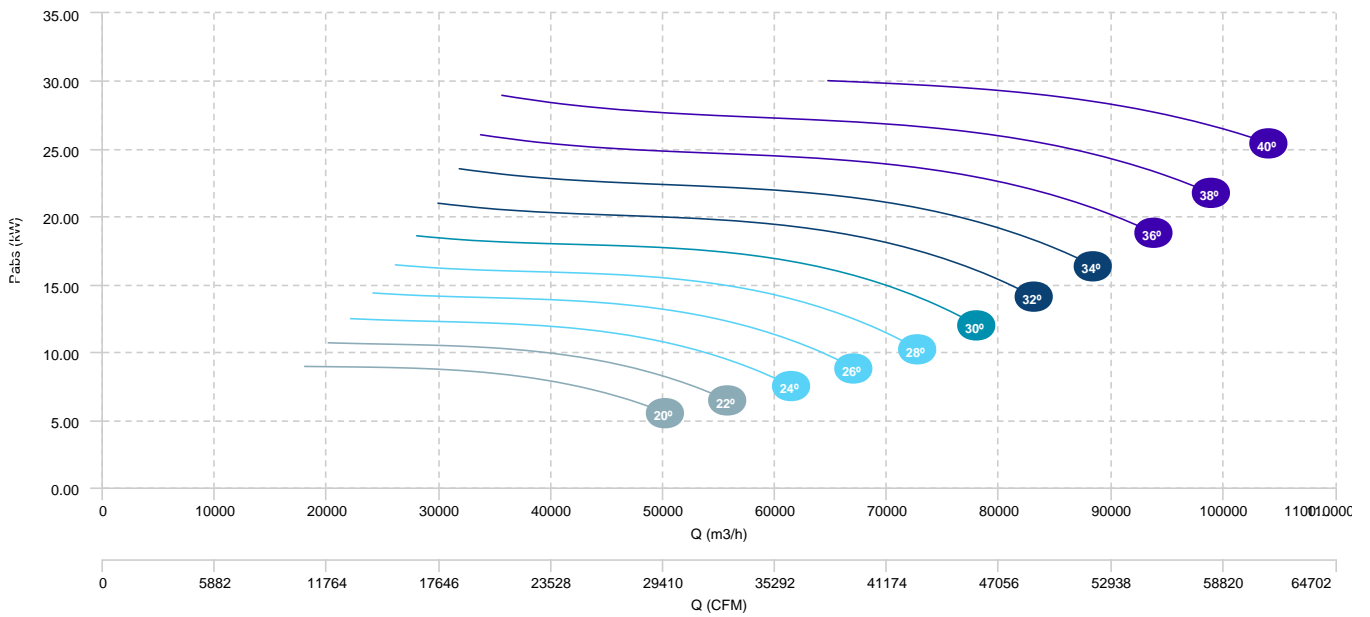

HM 112 T4 5,5kW (A6:3)	HM 112 T4 7,5kW (A6:3)	HM 112 T4 11kW (A6:3)
HM 112 T4 15kW (A6:3)	HM 112 T4 18,5kW (A6:3)	HM 112 T4 22kW (A6:3)

## AIR FLOW - PRESSURE

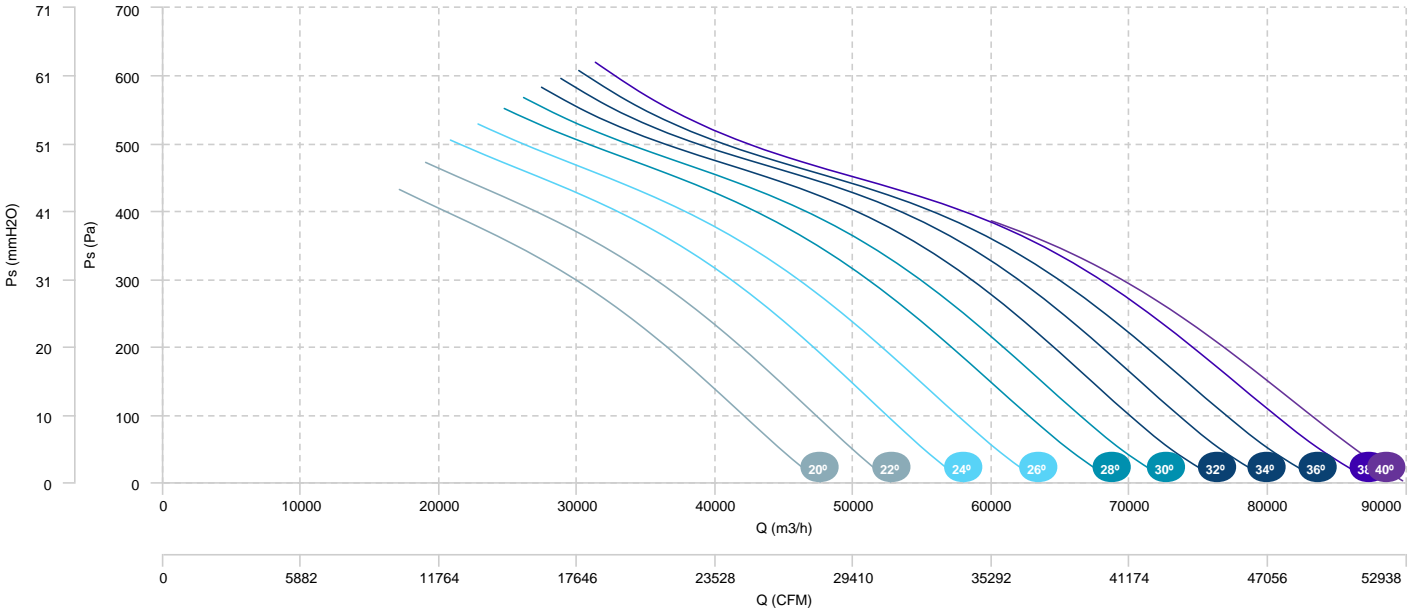

## AIR FLOW - ABSORBED POWER

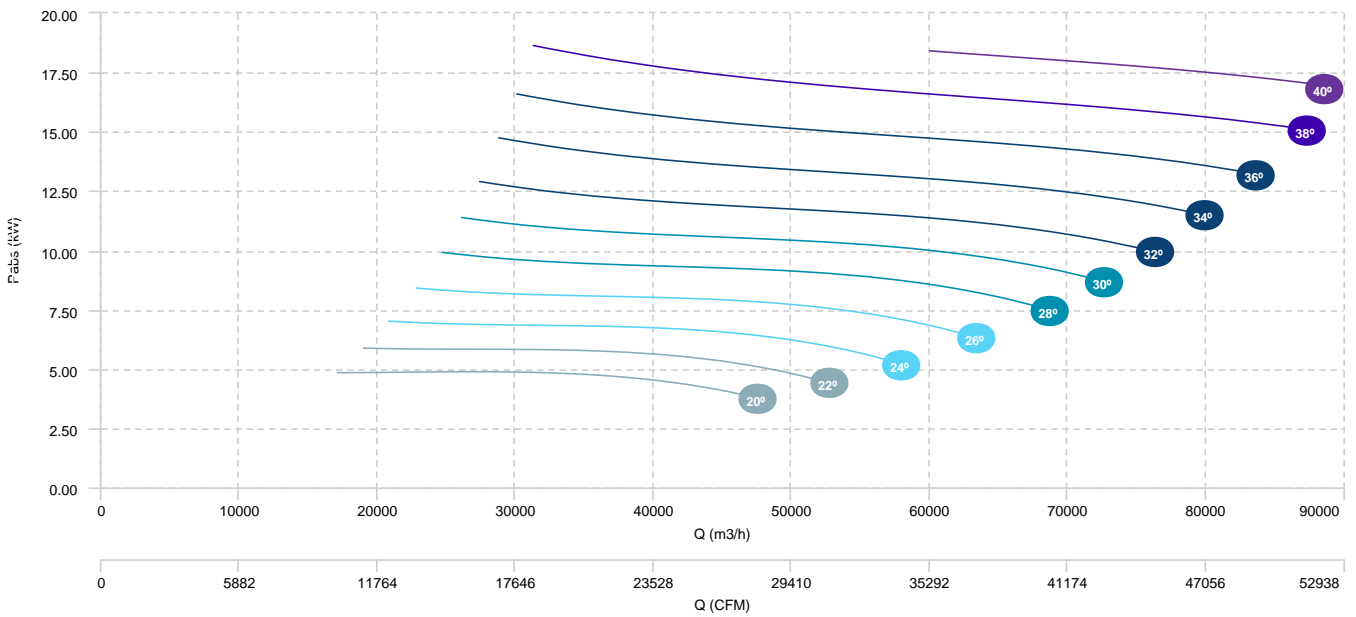

HM 112 T6 2,2kW (A6:6)	HM 112 T6 3kW (A6:6)	HM 112 T6 4kW (A6:6)
HM 112 T6 5,5kW (A6:6)	HM 112 T6 7,5kW (A6:6)	HM 112 T6 11kW (A6:6)

## AIR FLOW - PRESSURE

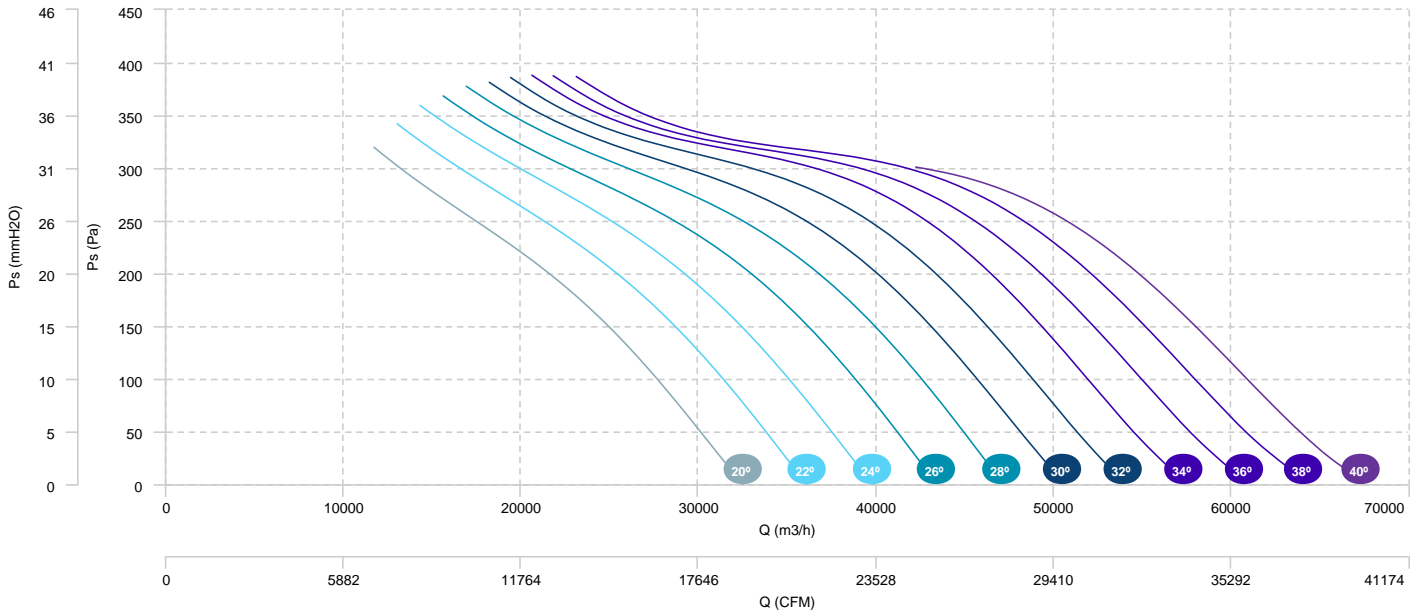

## AIR FLOW - ABSORBED POWER

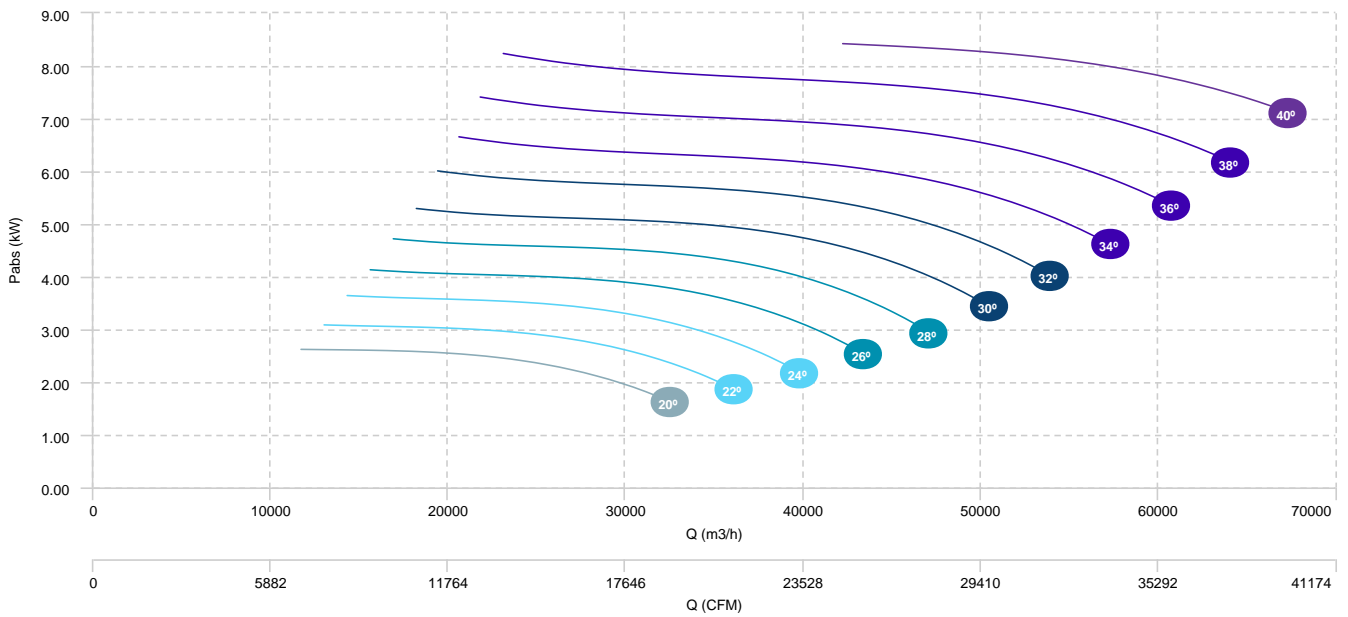

- HM 112 T6 2,2kW (A6:3)
- HM 112 T6 3kW (A6:3)
- HM 112 T6 4kW (A6:3)
- HM 112 T6 5,5kW (A6:3)

## AIR FLOW - PRESSURE

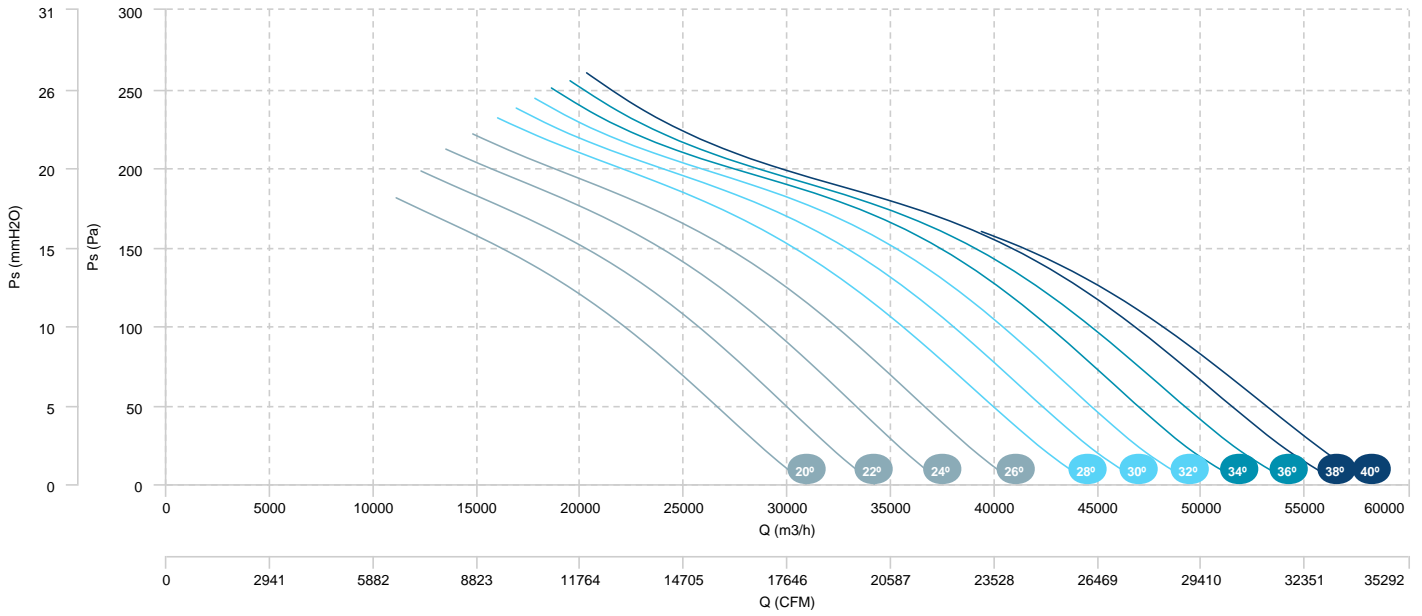

## AIR FLOW - ABSORBED POWER

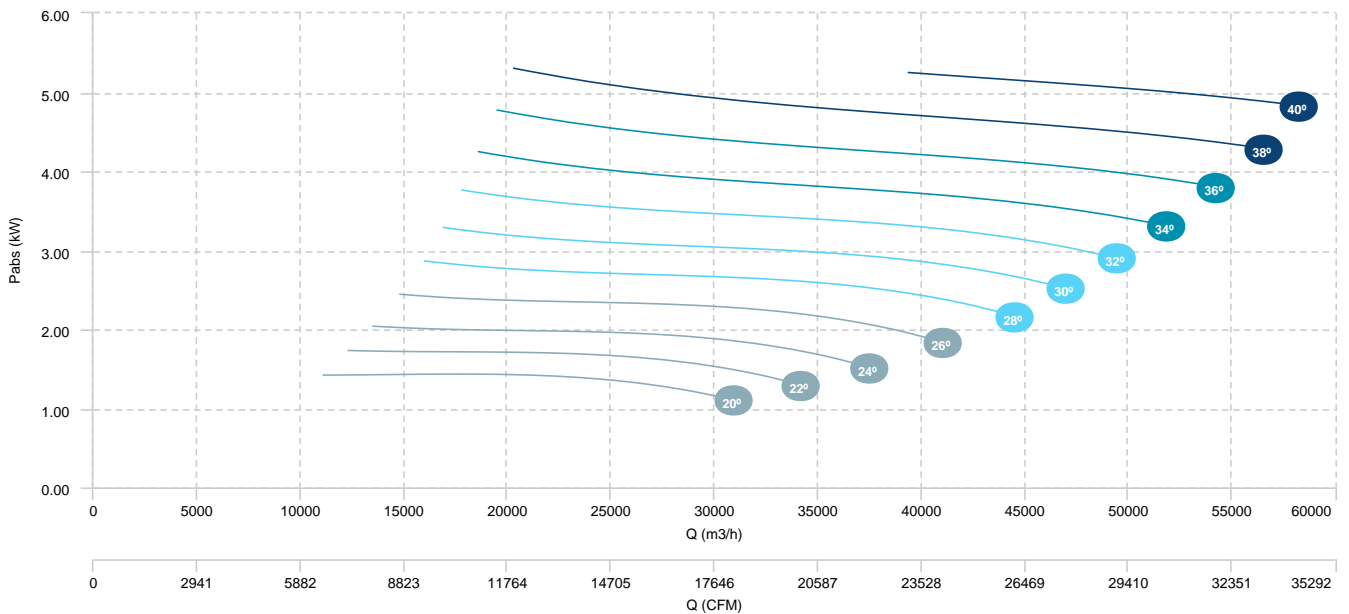

HM 112 T4/T6 11/3,6kW (A6:6)  
 HM 112 T4/T6 22/7,5kW (A6:6)

HM 112 T4/T6 15/4,4kW (A6:6)

HM 112 T4/T6 18,5/6kW (A6:6)

## AIR FLOW - PRESSURE (4 poles)

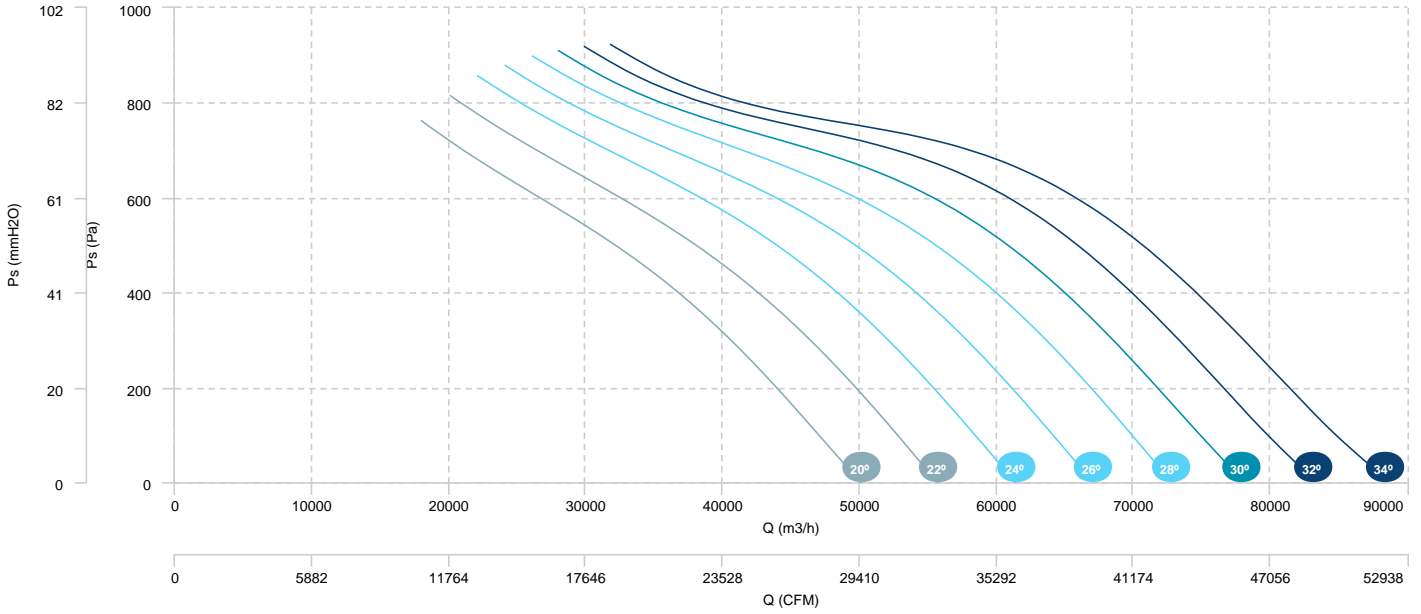

## AIR FLOW - ABSORBED POWER (4 poles)

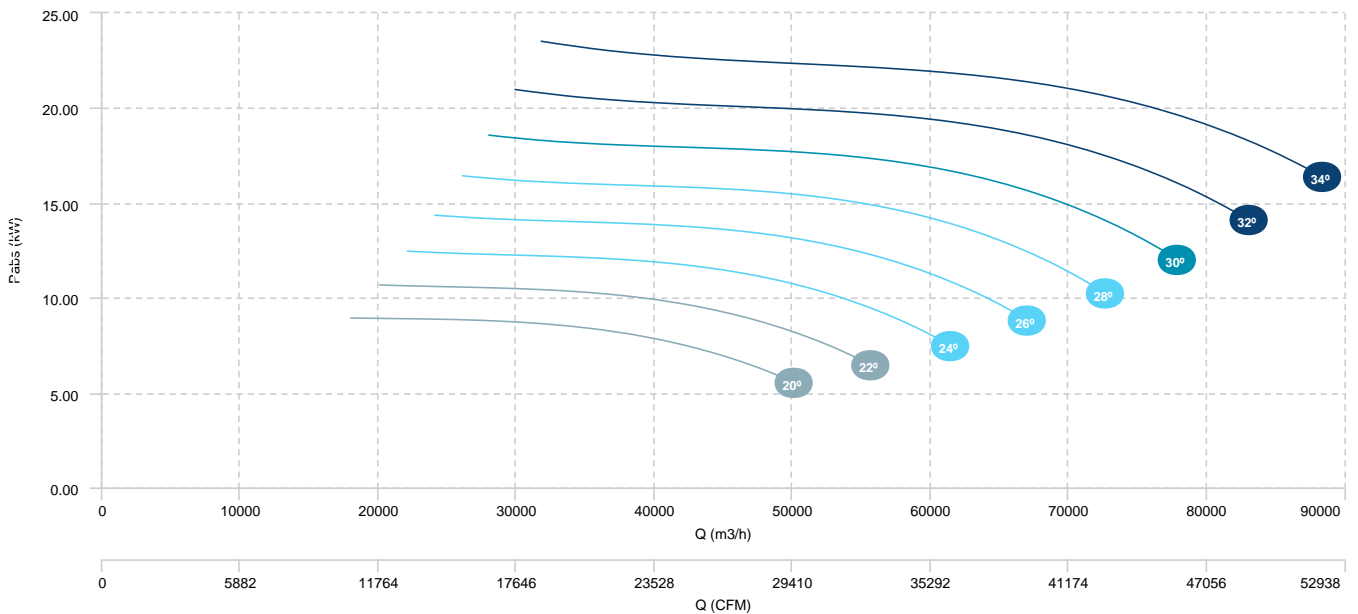



HM 112 T4/T6 11/3,6kW (A6:6)	HM 112 T4/T6 15/4,4kW (A6:6)	HM 112 T4/T6 18,5/6kW (A6:6)
HM 112 T4/T6 22/7,5kW (A6:6)		

AIR FLOW - PRESSURE (6 poles)

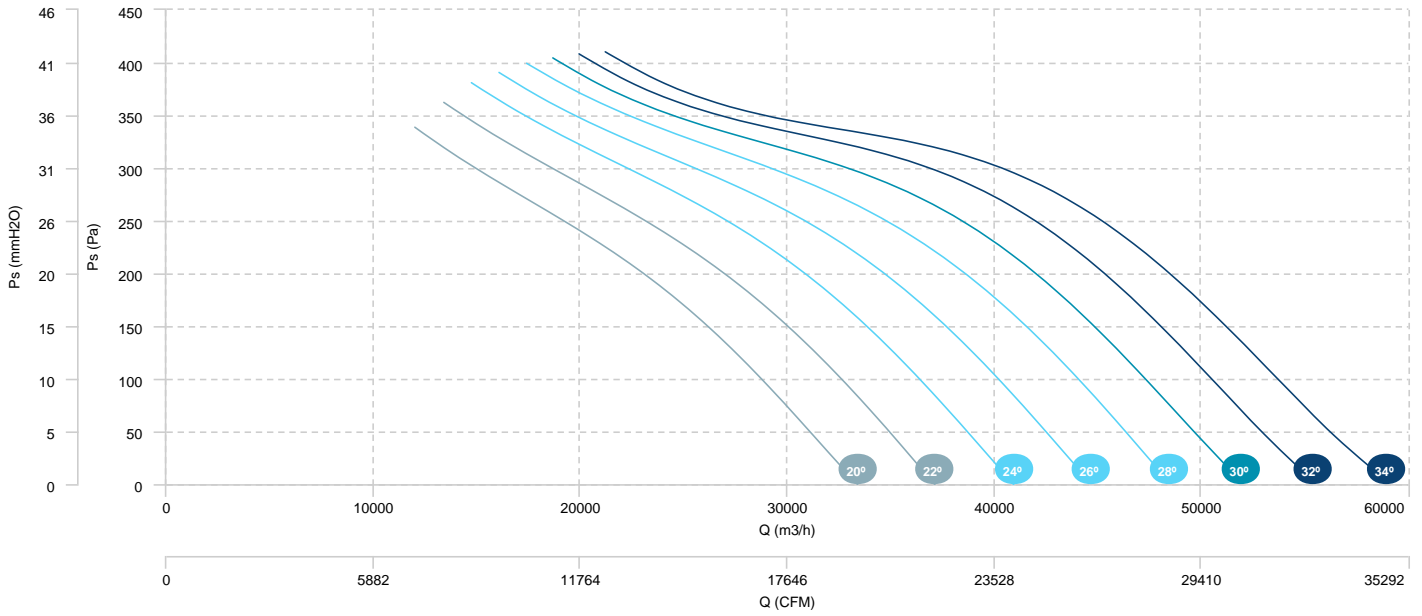

HM 112 T4/T6 5,5/1,85kW (A6:3)	HM 112 T4/T6 7,5/2,2kW (A6:3)	HM 112 T4/T6 11/3,6kW (A6:3)
HM 112 T4/T6 15/4,4kW (A6:3)	HM 112 T4/T6 18,5/6kW (A6:3)	HM 112 T4/T6 22/7,5kW (A6:3)

## AIR FLOW - PRESSURE (4 poles)

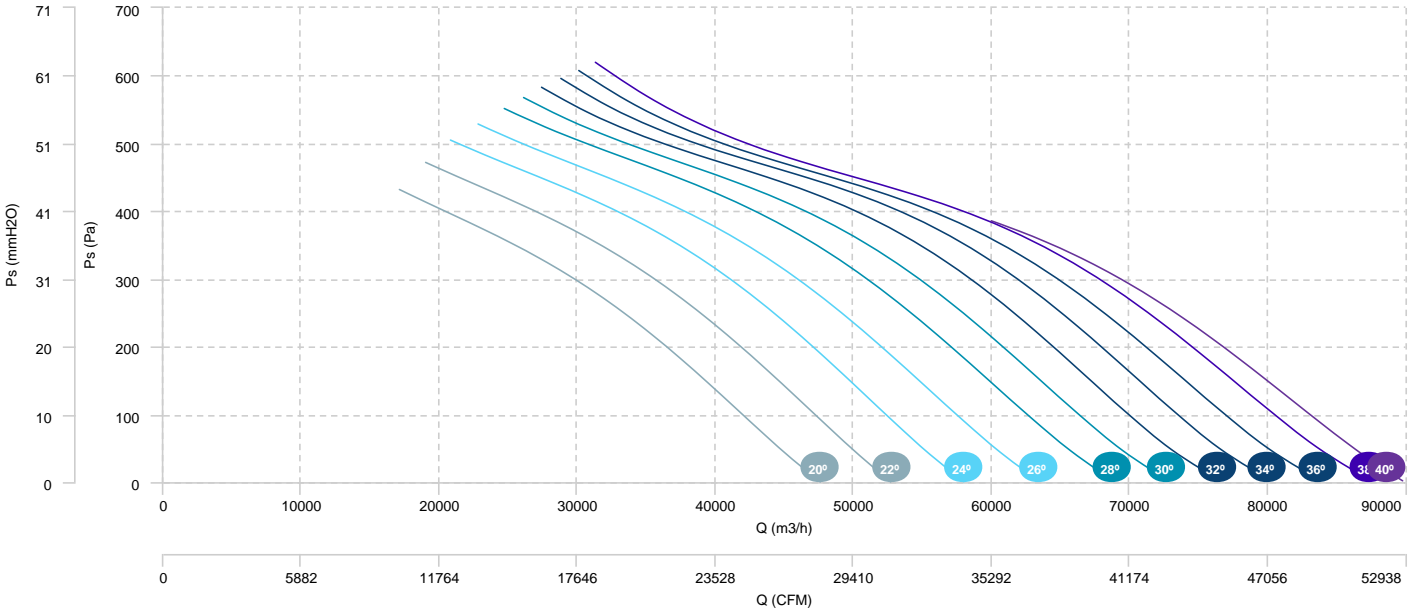

## AIR FLOW - ABSORBED POWER (4 poles)

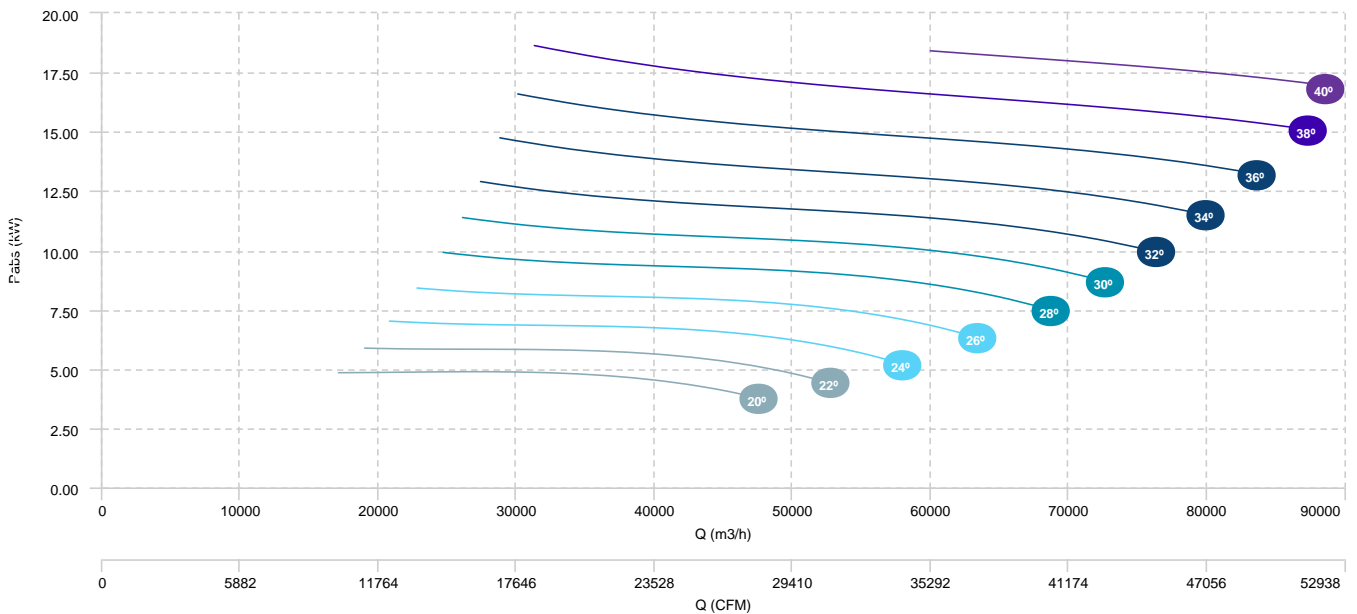

HM 112 T4/T6 5,5/1,85kW (A6:3)	HM 112 T4/T6 7,5/2,2kW (A6:3)	HM 112 T4/T6 11/3,6kW (A6:3)
HM 112 T4/T6 15/4,4kW (A6:3)	HM 112 T4/T6 18,5/6kW (A6:3)	HM 112 T4/T6 22/7,5kW (A6:3)

## AIR FLOW - PRESSURE (6 poles)

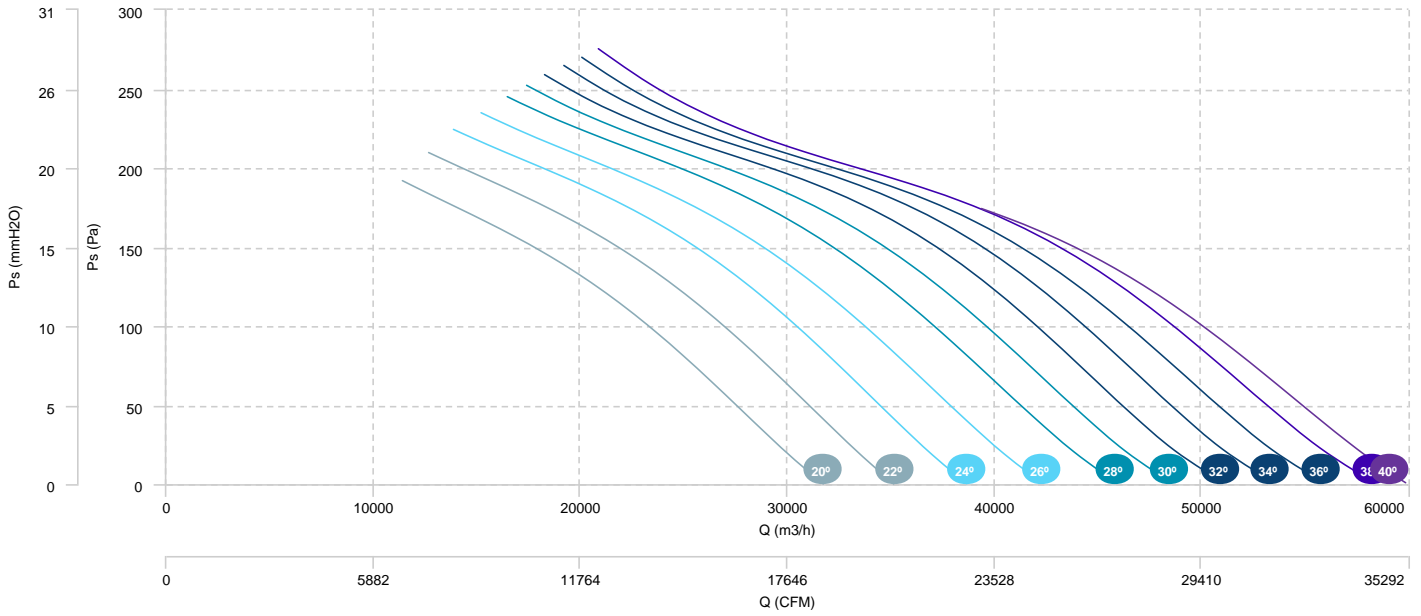

HM 112 T4/T8 11/3kW (A6:6)	HM 112 T4/T8 15/3,5kW (A6:6)	HM 112 T4/T8 17/4,3kW (A6:6)
HM 112 T4/T8 20/5kW (A6:6)	HM 112 T4/T8 28/6,5kW (A6:6)	HM 112 T4/T8 35/8kW (A6:6)

## AIR FLOW - PRESSURE (4 poles)

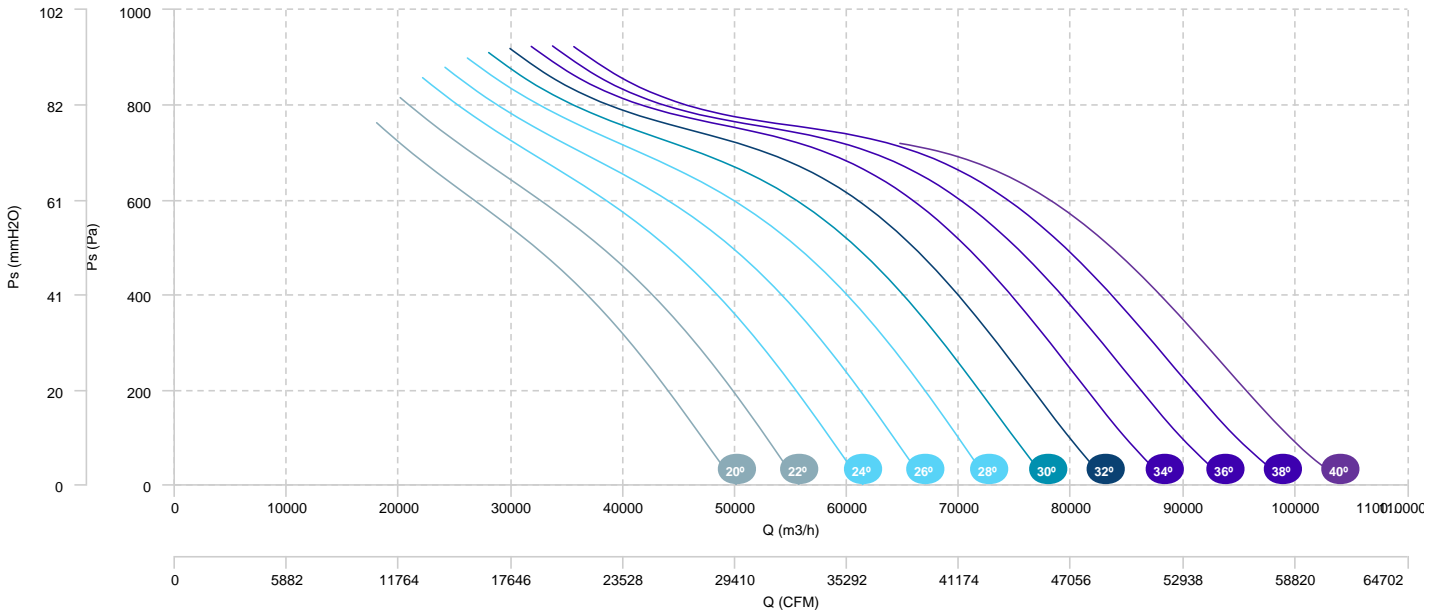

## AIR FLOW - ABSORBED POWER (4 poles)

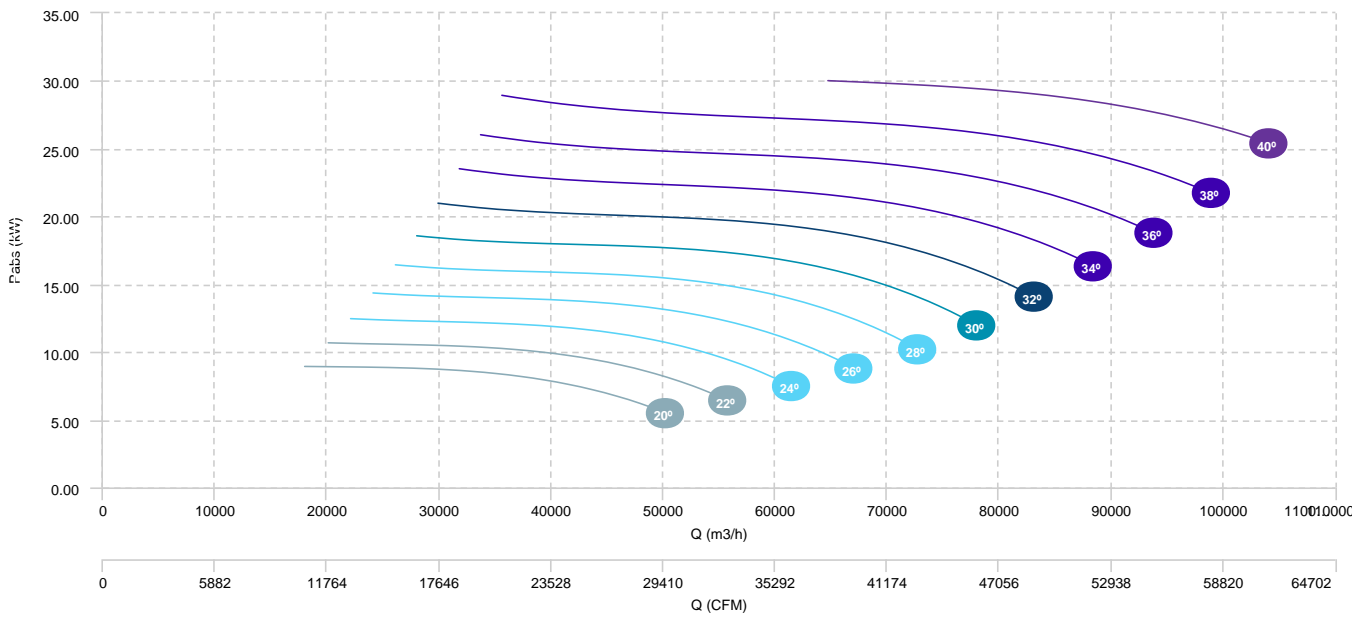

HM 112 T4/T8 11/3kW (A6:6)	HM 112 T4/T8 15/3,5kW (A6:6)	HM 112 T4/T8 17/4,3kW (A6:6)
HM 112 T4/T8 20/5kW (A6:6)	HM 112 T4/T8 28/6,5kW (A6:6)	HM 112 T4/T8 35/8kW (A6:6)

## AIR FLOW - PRESSURE (8 poles)

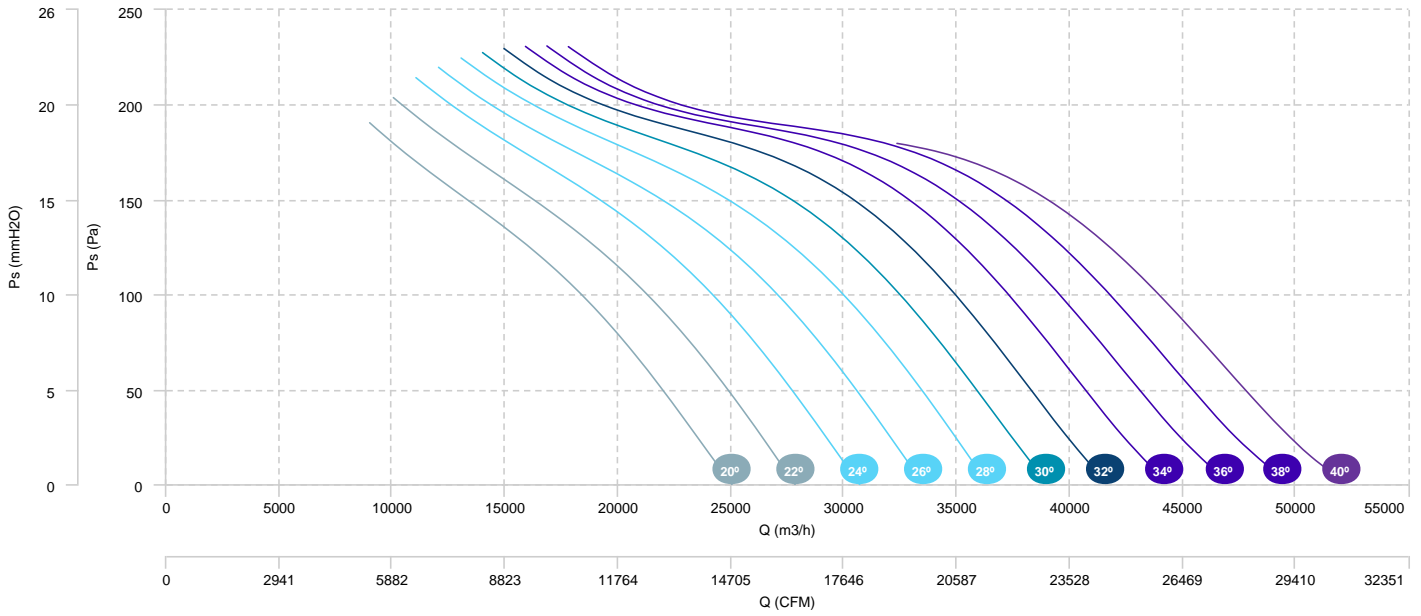

HM 112 T4/T8 5,5/1,1kW (A6:3)	HM 112 T4/T8 7,5/1,5kW (A6:3)	HM 112 T4/T8 11/3kW (A6:3)
HM 112 T4/T8 15/3,5kW (A6:3)	HM 112 T4/T8 17/4,3kW (A6:3)	HM 112 T4/T8 20/5kW (A6:3)

## AIR FLOW - PRESSURE (4 poles)

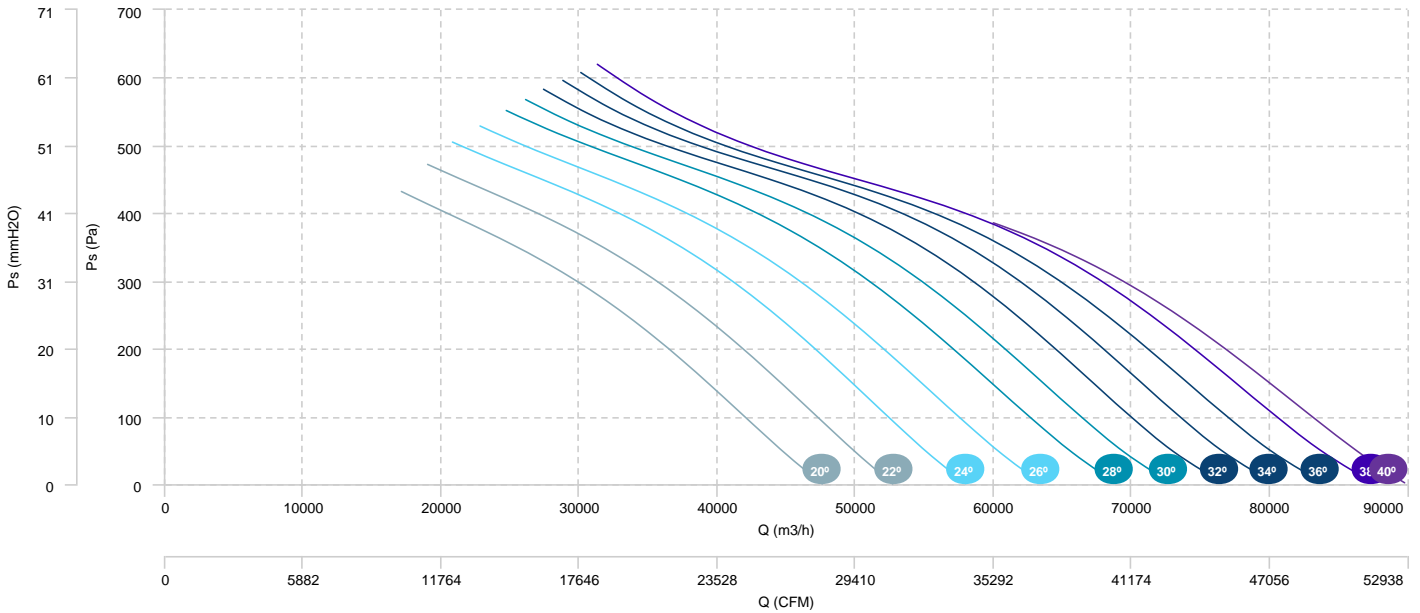

## AIR FLOW - ABSORBED POWER (4 poles)

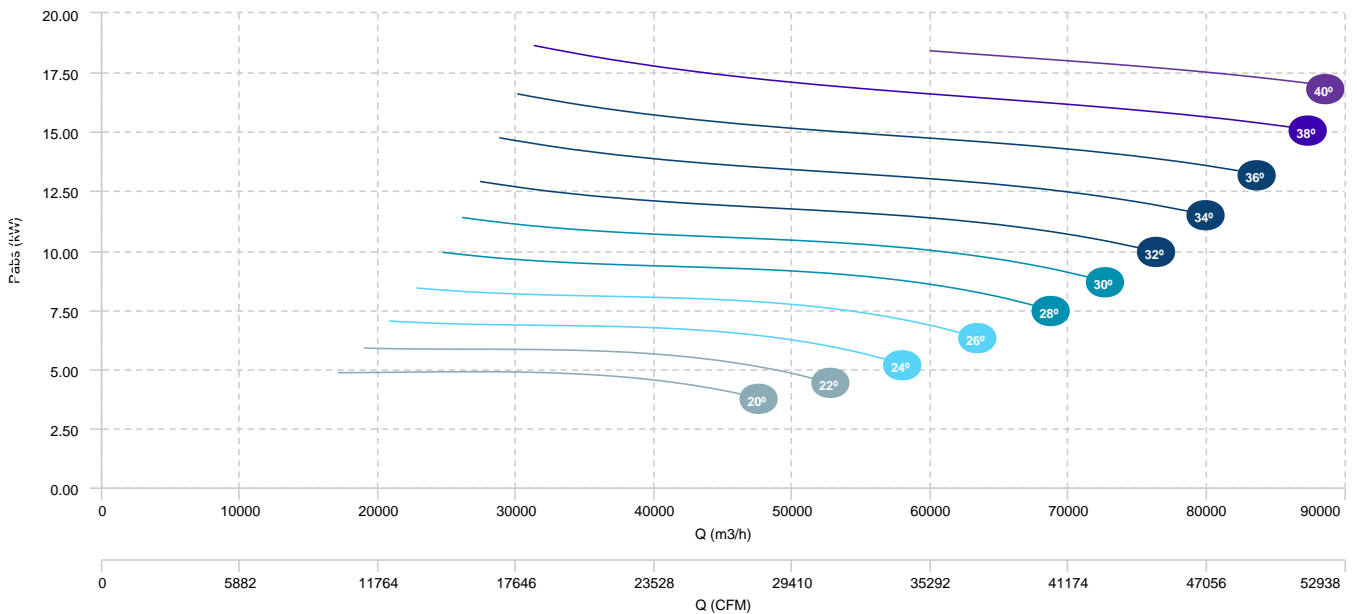

HM 112 T4/T8 5,5/1,1kW (A6:3)	HM 112 T4/T8 7,5/1,5kW (A6:3)	HM 112 T4/T8 11/3kW (A6:3)
HM 112 T4/T8 15/3,5kW (A6:3)	HM 112 T4/T8 17/4,3kW (A6:3)	HM 112 T4/T8 20/5kW (A6:3)

**AIR FLOW - PRESSURE (8 poles)**

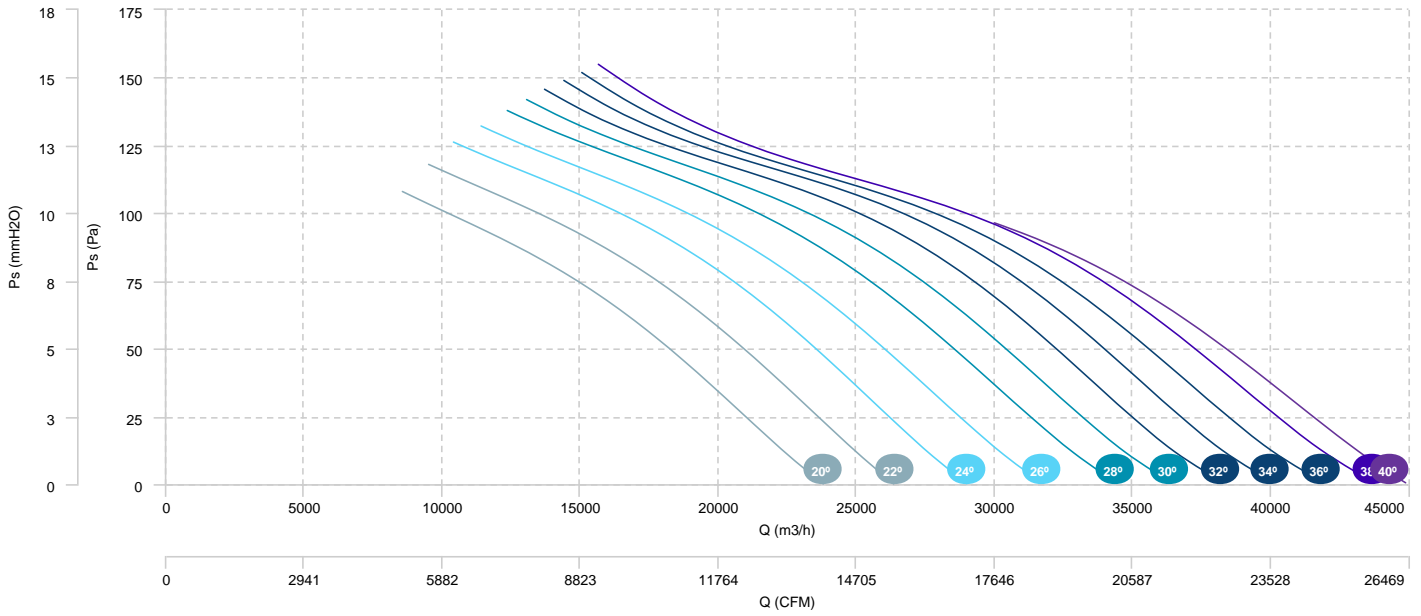

HM 125 T4 15kW (A7:8)	HM 125 T4 18,5kW (A7:8)	HM 125 T4 22kW (A7:8)
HM 125 T4 30kW (A7:8)	HM 125 T4 37kW (A7:8)	HM 125 T4 45kW (A7:8)

## AIR FLOW - PRESSURE

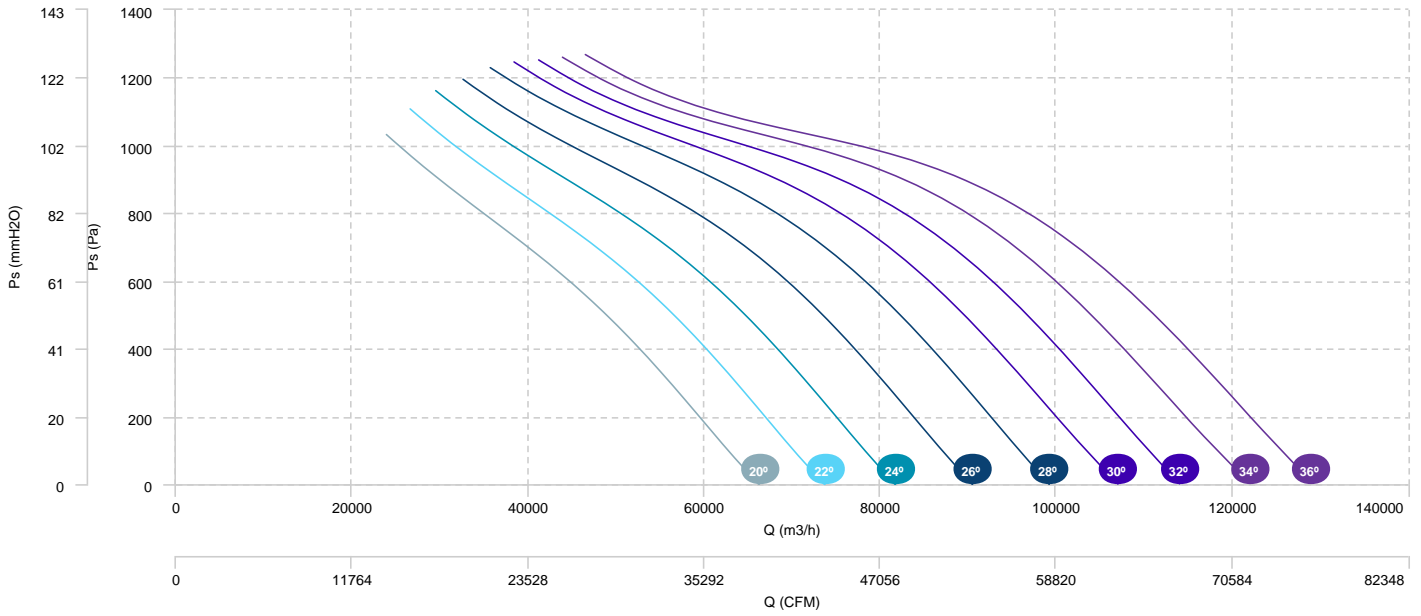

## AIR FLOW - ABSORBED POWER

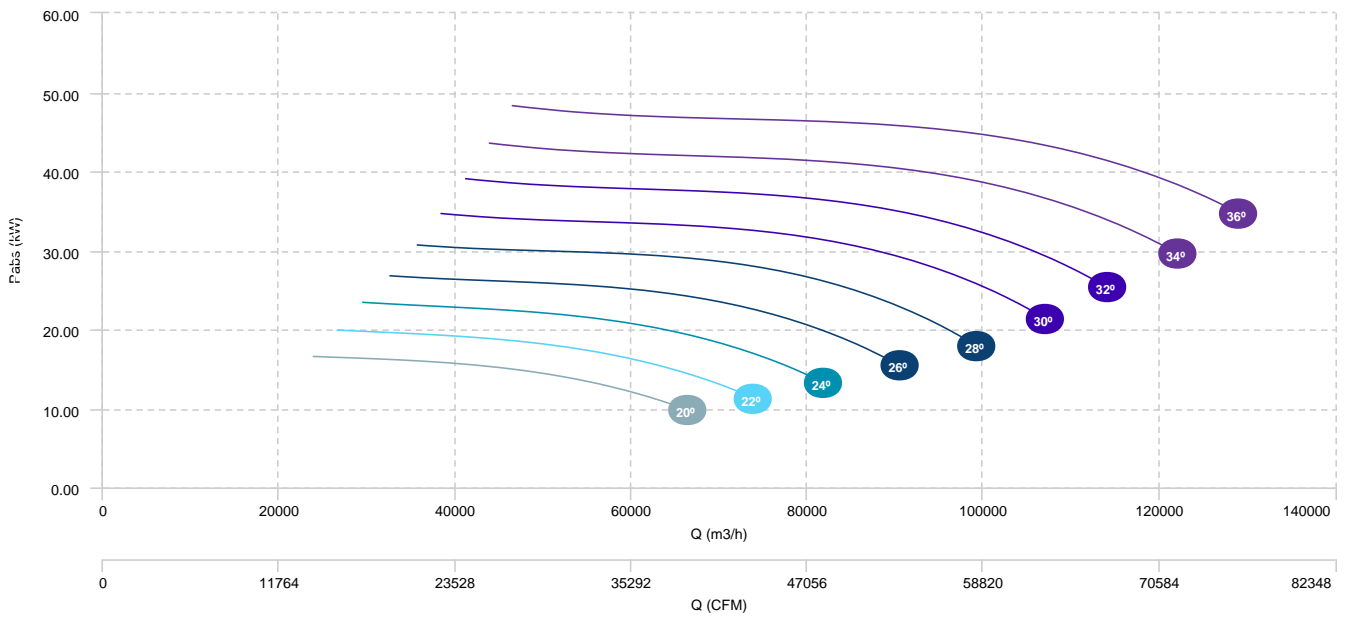



HM 125 T4 11kW (A7:4)	HM 125 T4 15kW (A7:4)	HM 125 T4 18,5kW (A7:4)
HM 125 T4 22kW (A7:4)	HM 125 T4 30kW (A7:4)	HM 125 T4 37kW (A7:4)

## AIR FLOW - PRESSURE

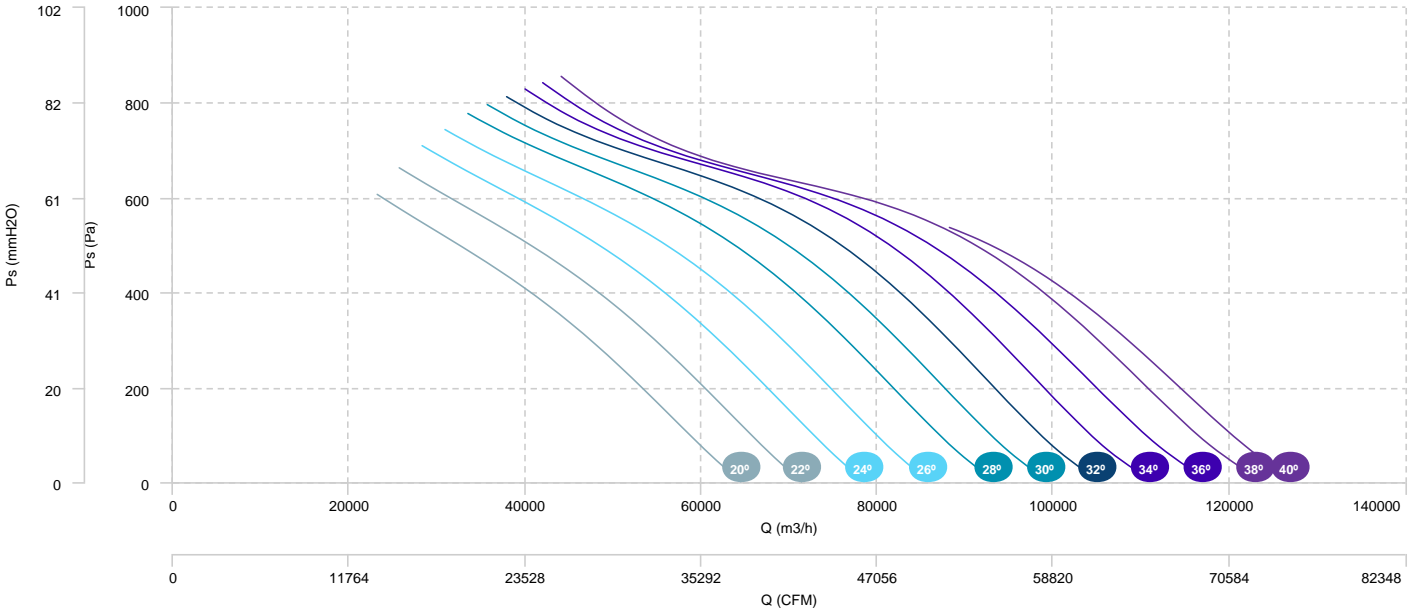

## AIR FLOW - ABSORBED POWER

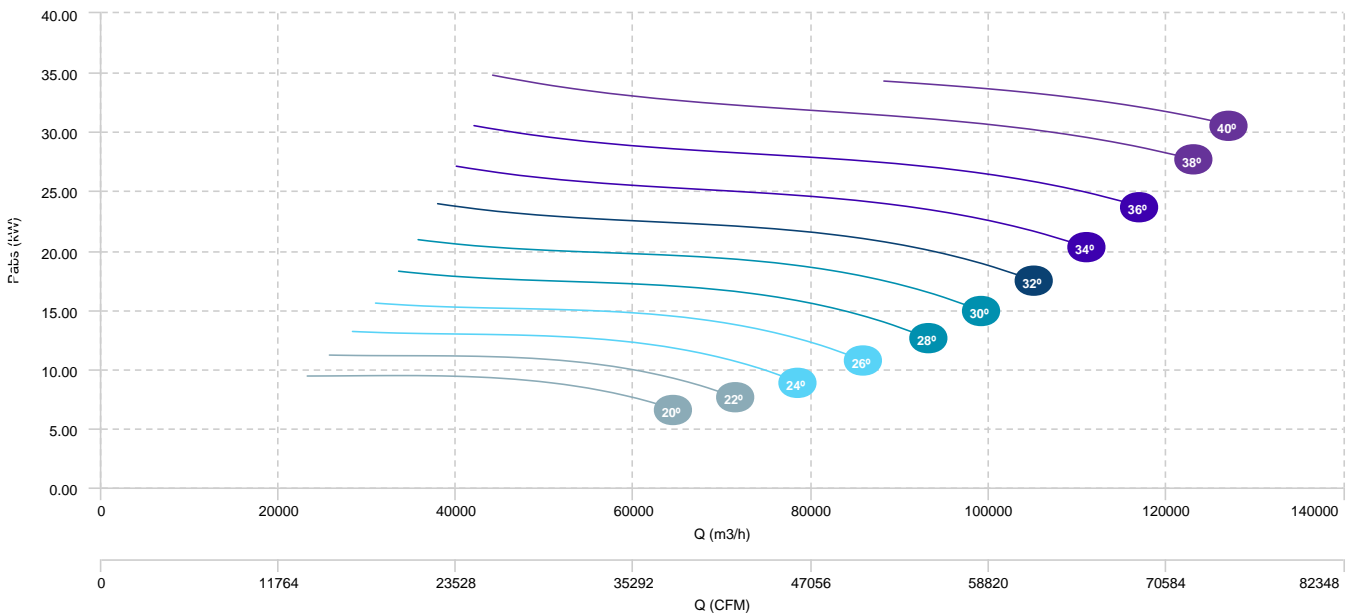

HM 125 T6 3kW (A7:4)	HM 125 T6 4kW (A7:4)	HM 125 T6 5,5kW (A7:4)
HM 125 T6 7,5kW (A7:4)	HM 125 T6 11kW (A7:4)	

## AIR FLOW - PRESSURE

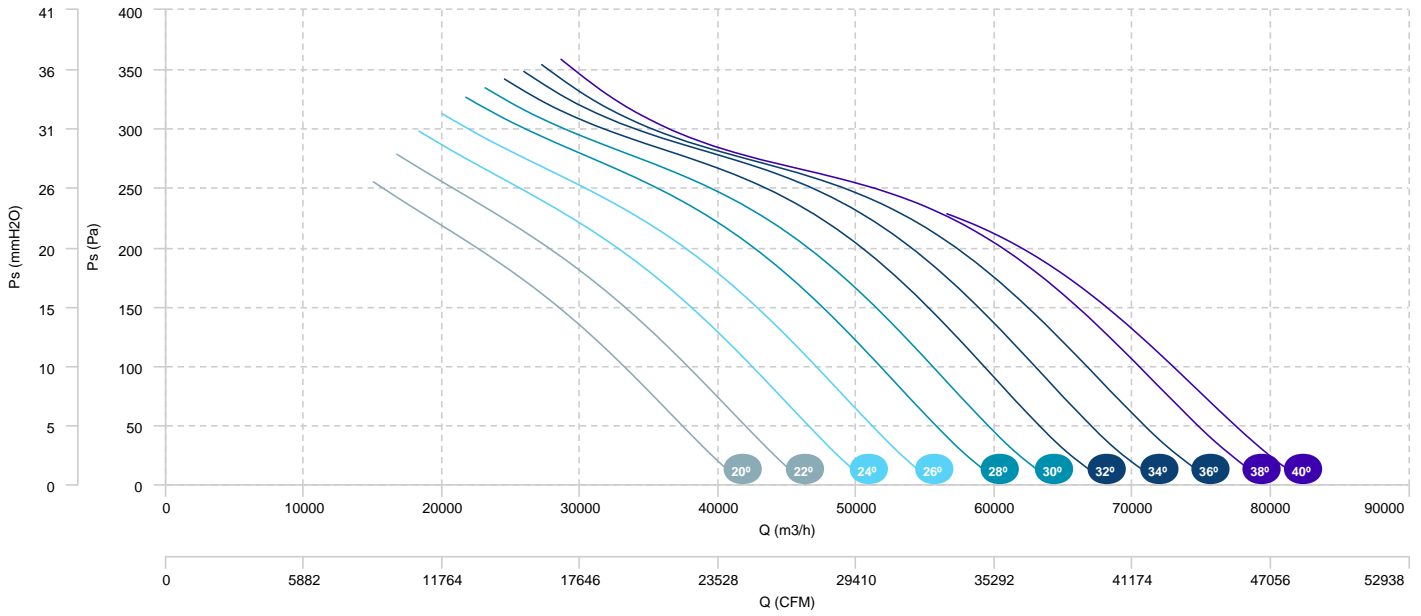

## AIR FLOW - ABSORBED POWER

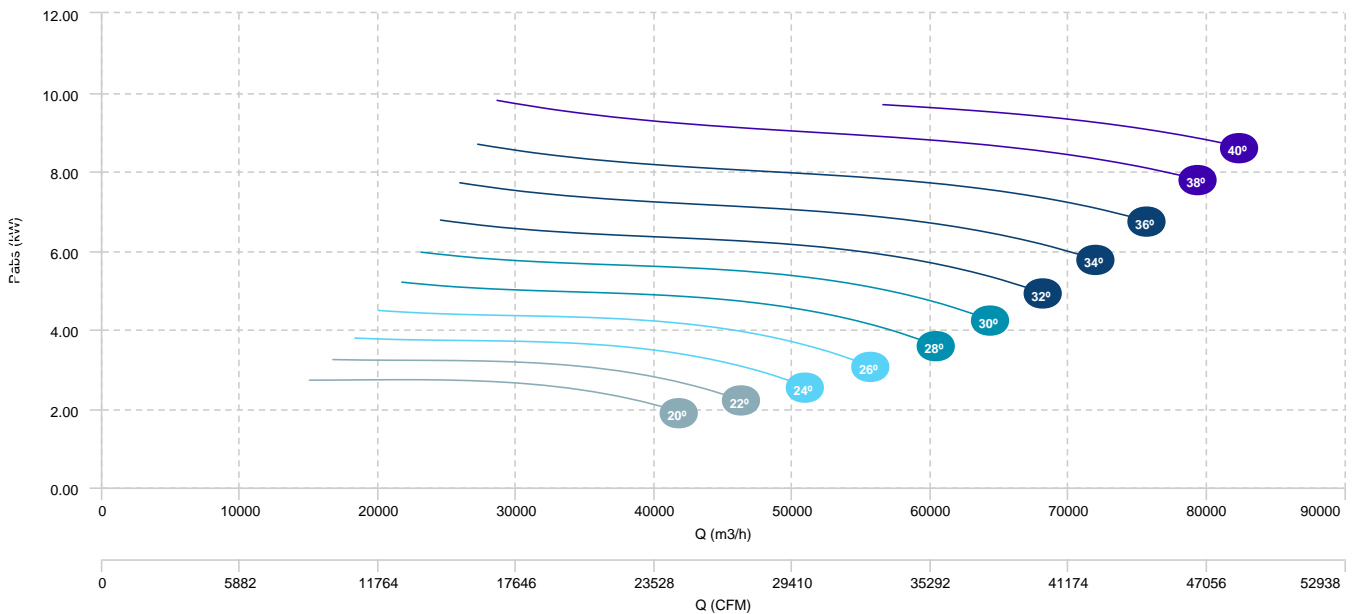

HM 125 T6 5,5kW (A7:8)

HM 125 T6 7,5kW (A7:8)

HM 125 T6 11kW (A7:8)

HM 125 T6 15kW (A7:8)

## AIR FLOW - PRESSURE

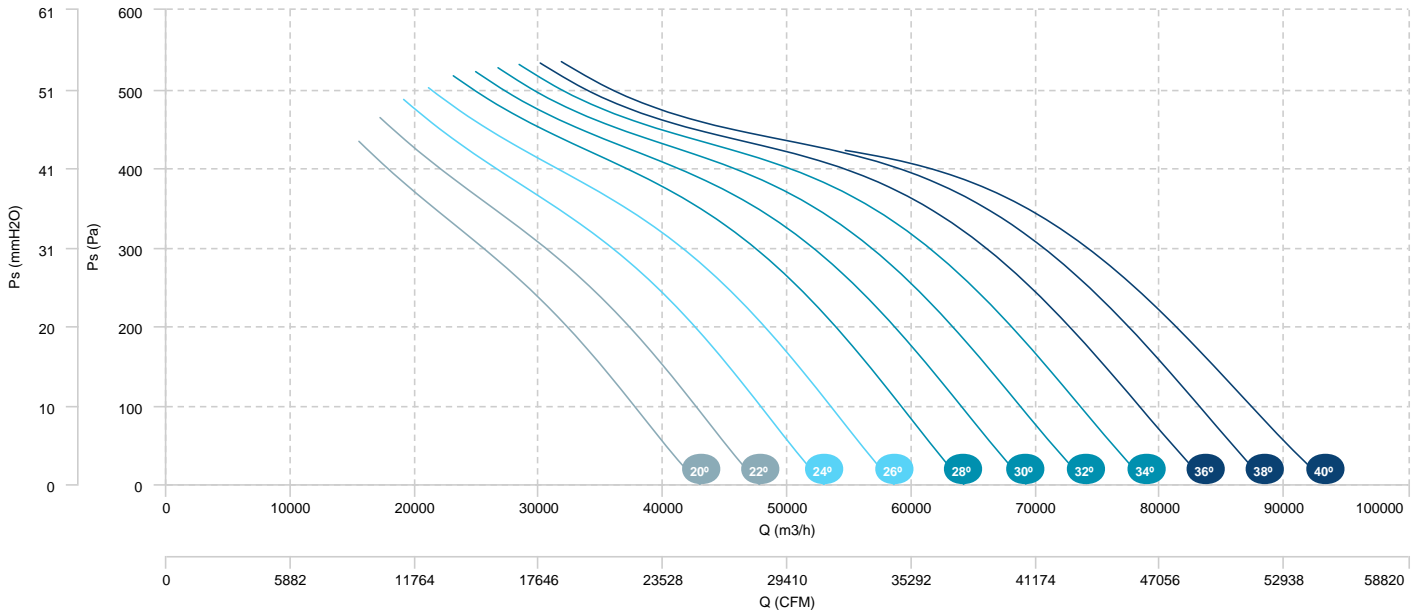

## AIR FLOW - ABSORBED POWER

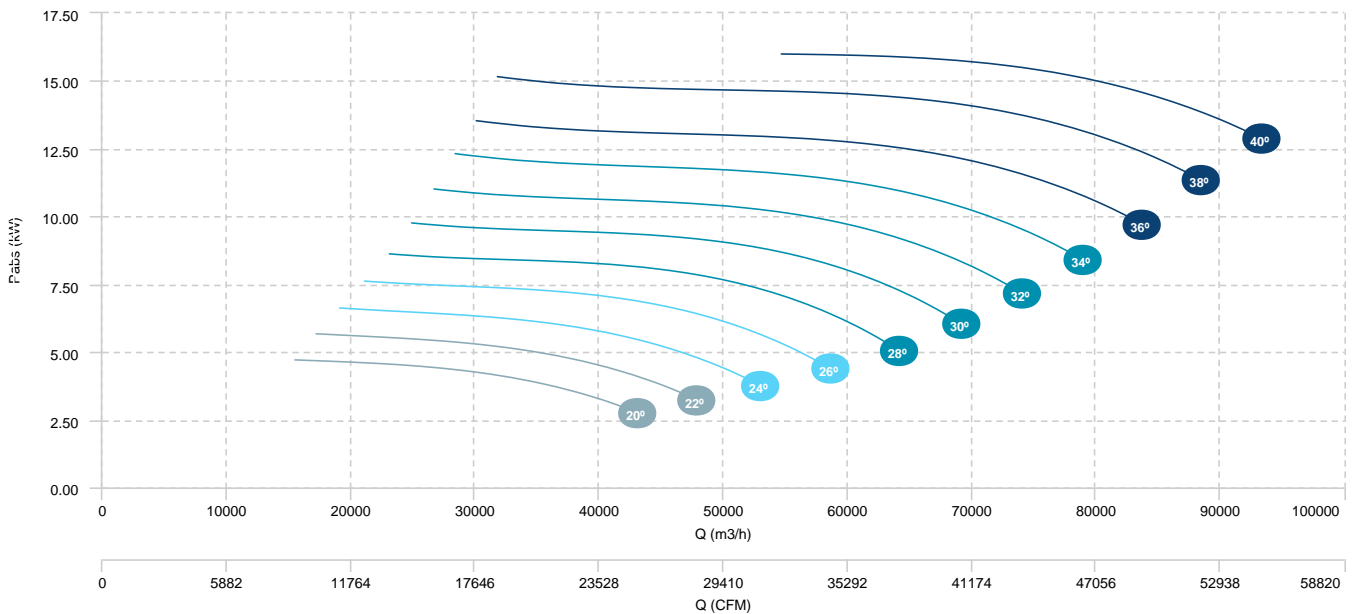

HM 125 T4/T6 15/4,4kW (A7:8)

HM 125 T4/T6 18,5/6kW (A7:8)

HM 125 T4/T6 22/7,5kW (A7:8)

AIR FLOW - PRESSURE (4 poles)

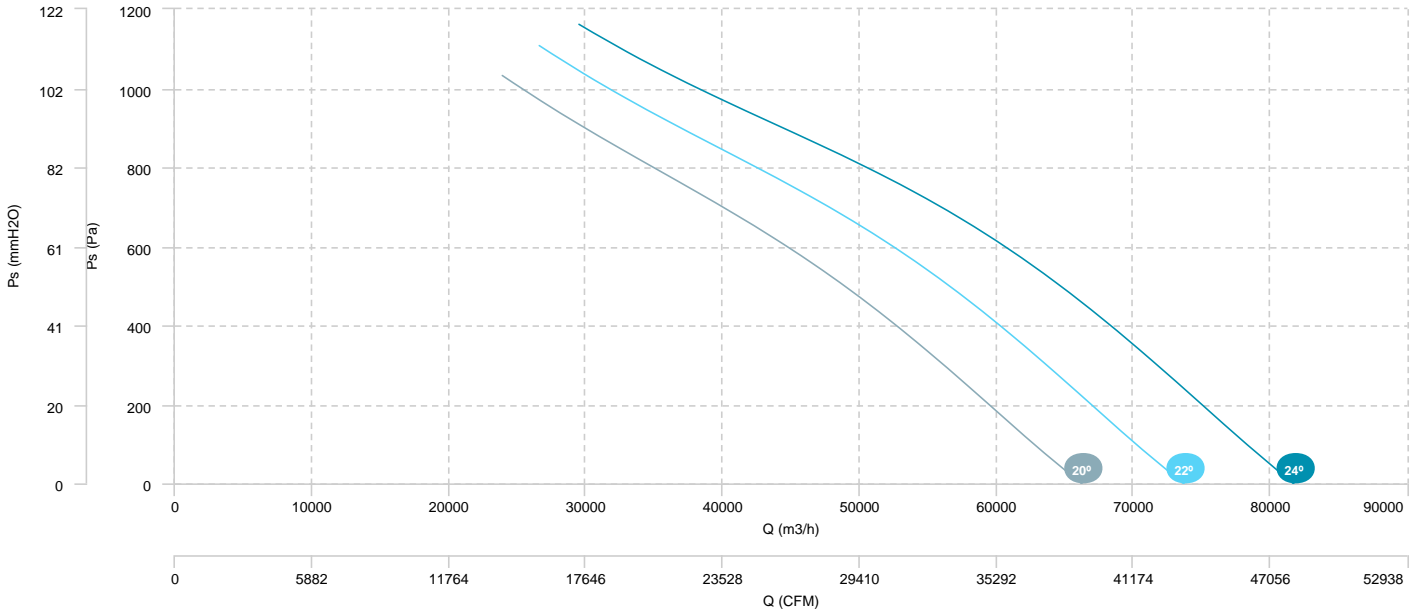

AIR FLOW - ABSORBED POWER (4 poles)

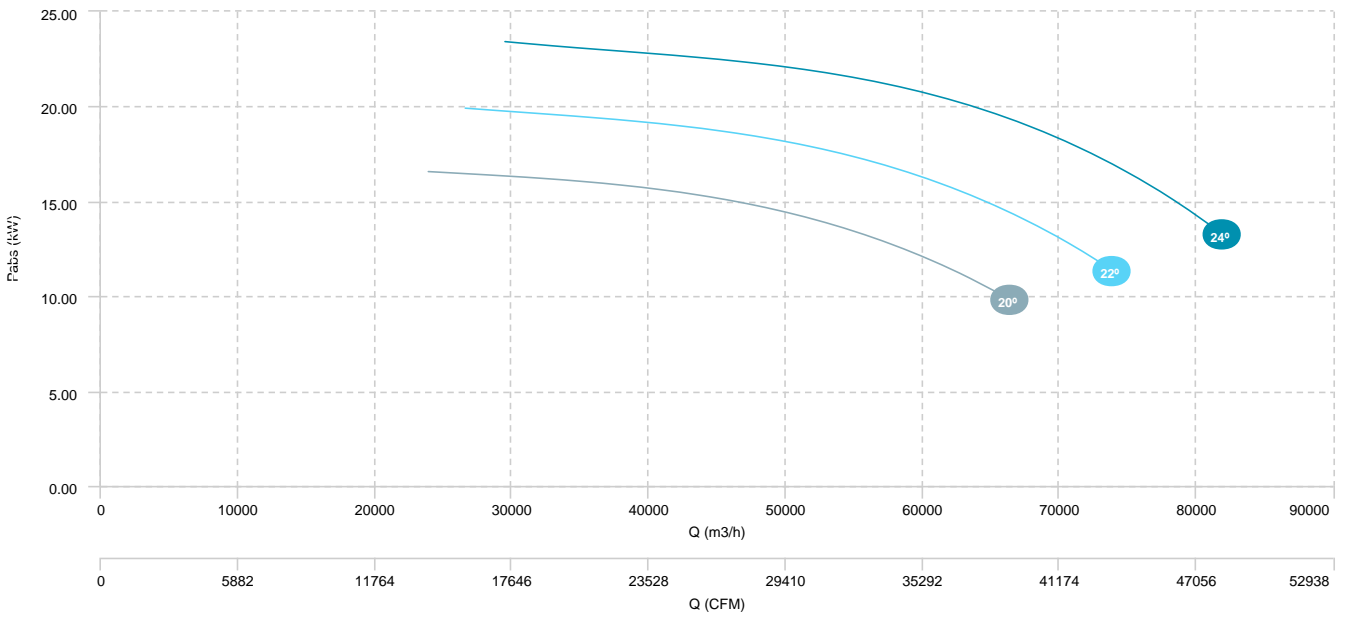

HM 125 T4/T6 15/4,4kW (A7:8)

HM 125 T4/T6 18,5/6kW (A7:8)

HM 125 T4/T6 22/7,5kW (A7:8)

AIR FLOW - PRESSURE (6 poles)

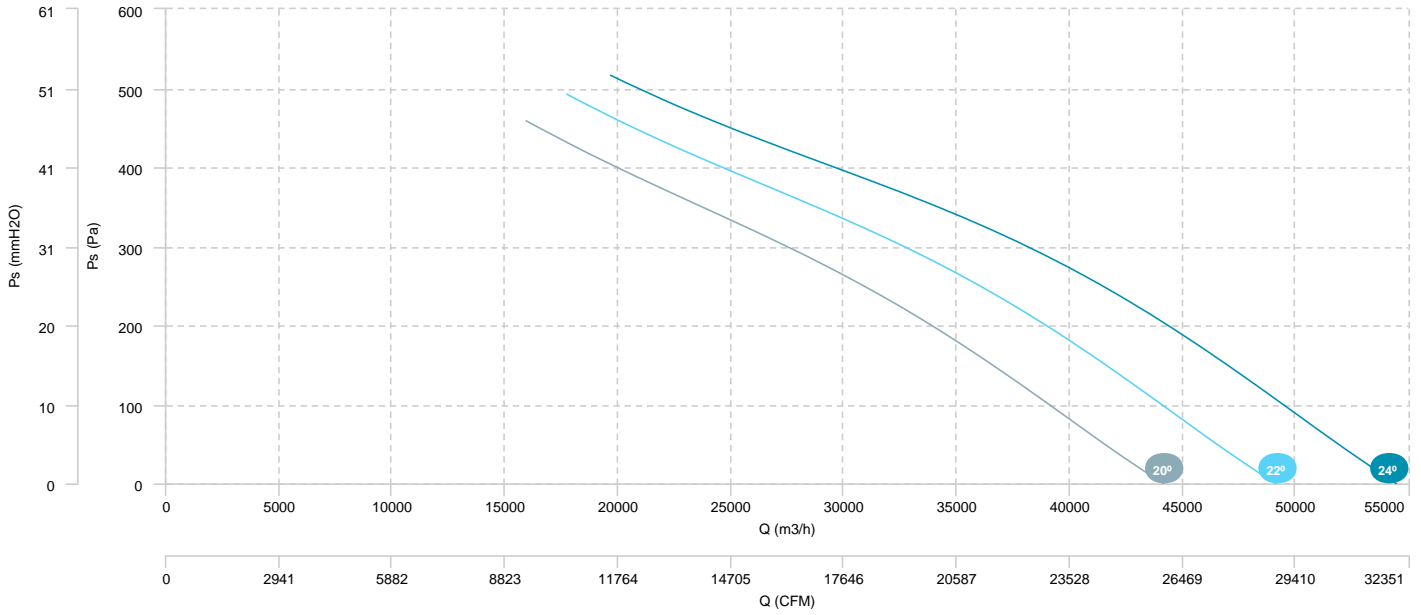

HM 125 T4/T6 11/3,6kW (A7:4)	HM 125 T4/T6 15/4,4kW (A7:4)	HM 125 T4/T6 18,5/6kW (A7:4)
HM 125 T4/T6 22/7,5kW (A7:4)		

## AIR FLOW - PRESSURE (4 poles)

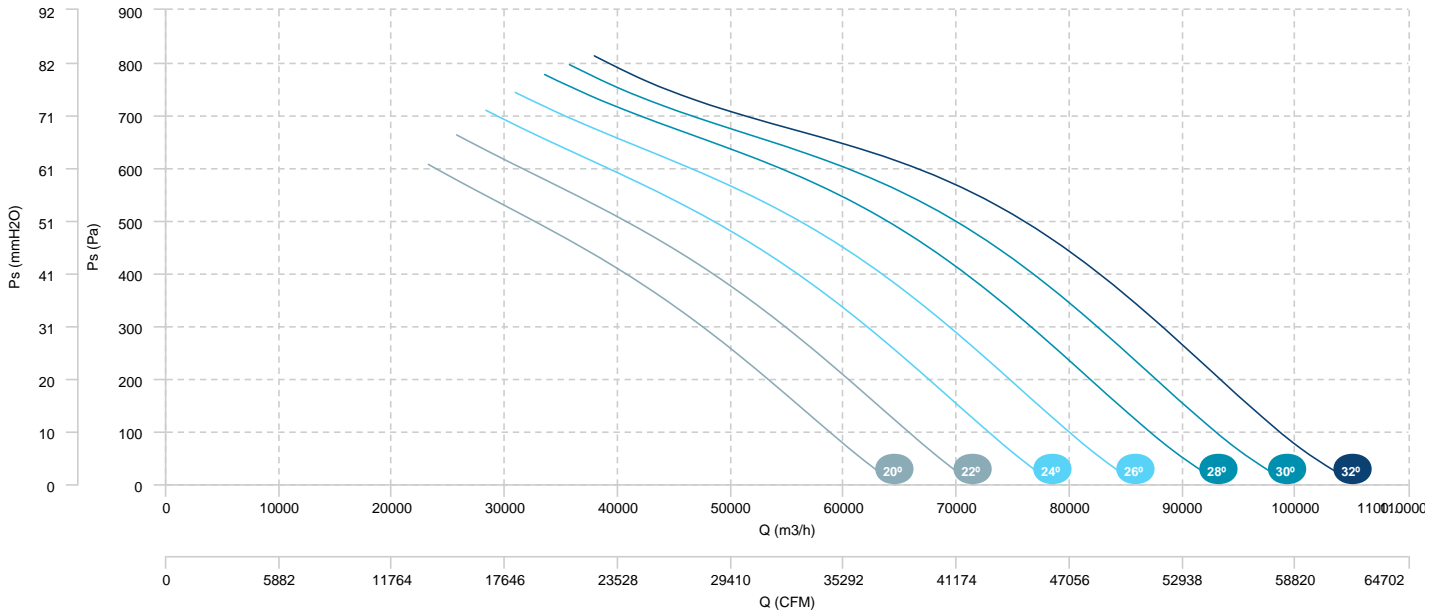

## AIR FLOW - ABSORBED POWER (4 poles)

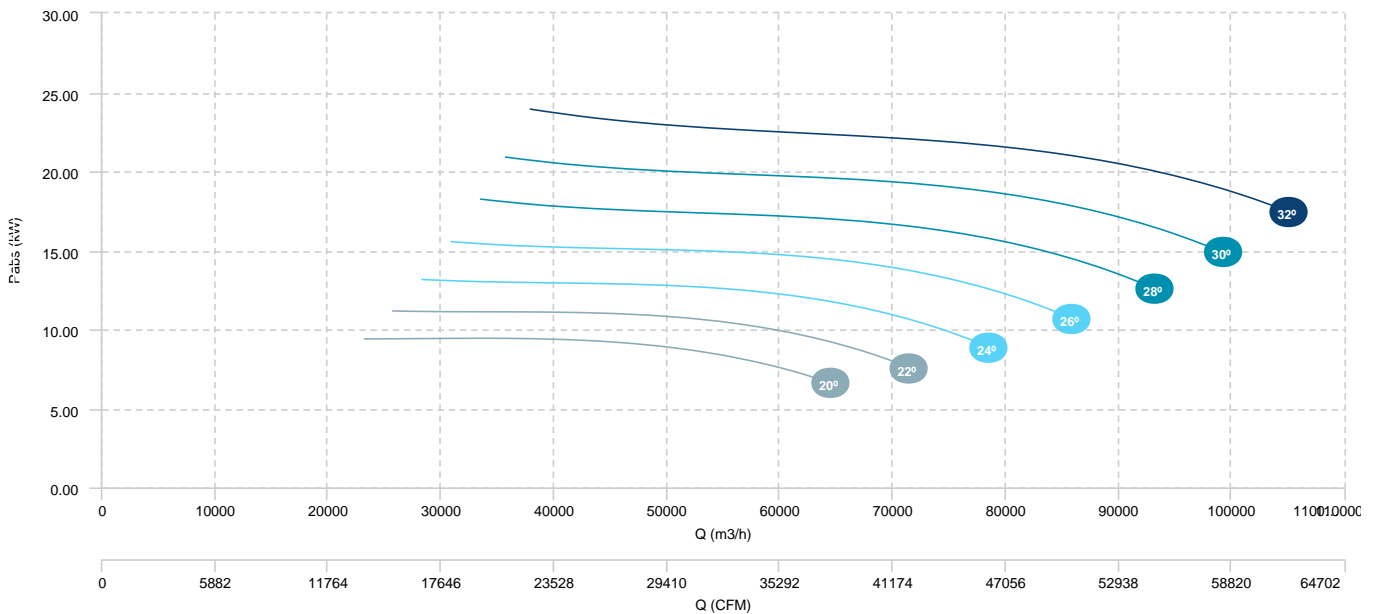

HM 125 T4/T6 11/3,6kW (A7:4)	HM 125 T4/T6 15/4,4kW (A7:4)	HM 125 T4/T6 18,5/6kW (A7:4)
HM 125 T4/T6 22/7,5kW (A7:4)		

## AIR FLOW - PRESSURE (6 poles)

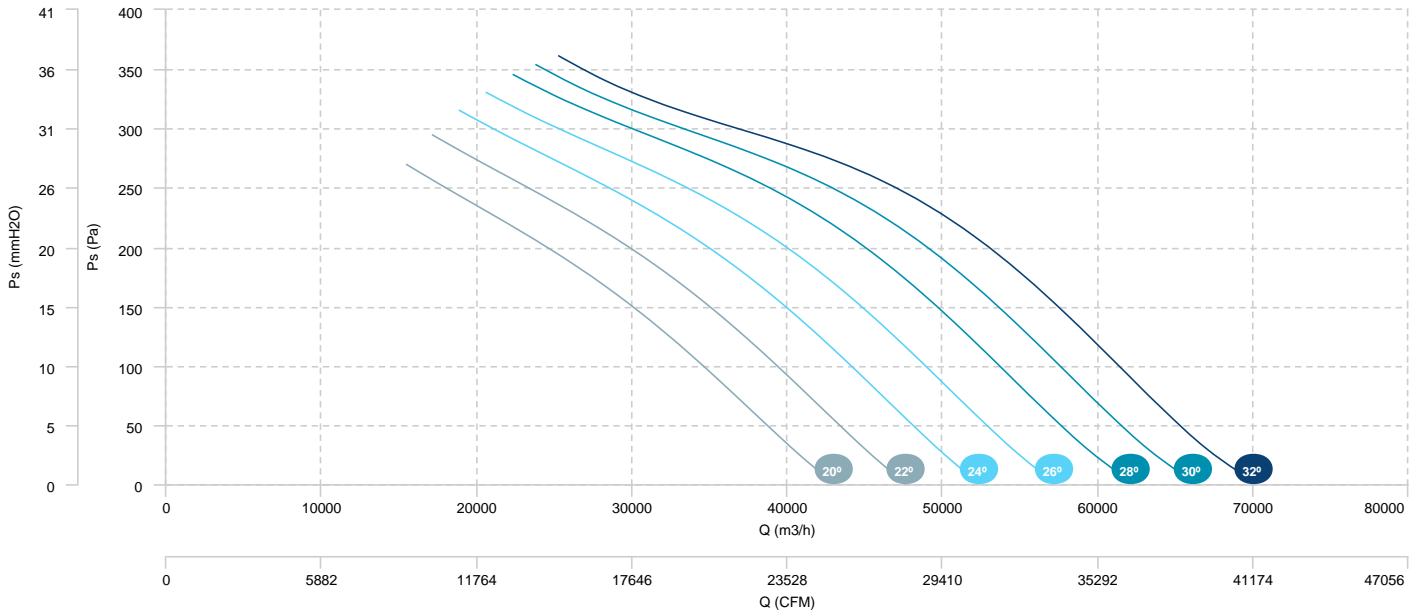

HM 125 T4/T8 15/3,5kW (A7:8)	HM 125 T4/T8 20/5kW (A7:8)	HM 125 T4/T8 28/6,5kW (A7:8)
HM 125 T4/T8 35/8kW (A7:8)	HM 125 T4/T8 37/9,2kW (A7:8)	HM 125 T4/T8 44/11kW (A7:8)

## AIR FLOW - PRESSURE (4 poles)

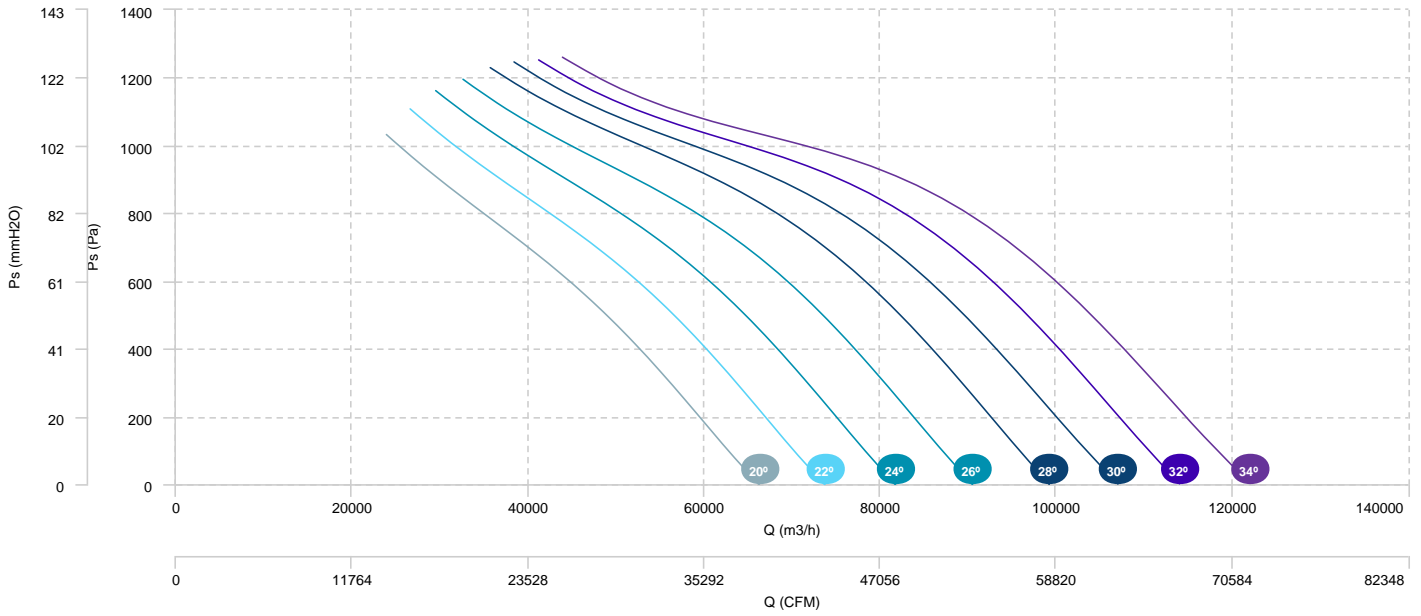

## AIR FLOW - ABSORBED POWER (4 poles)

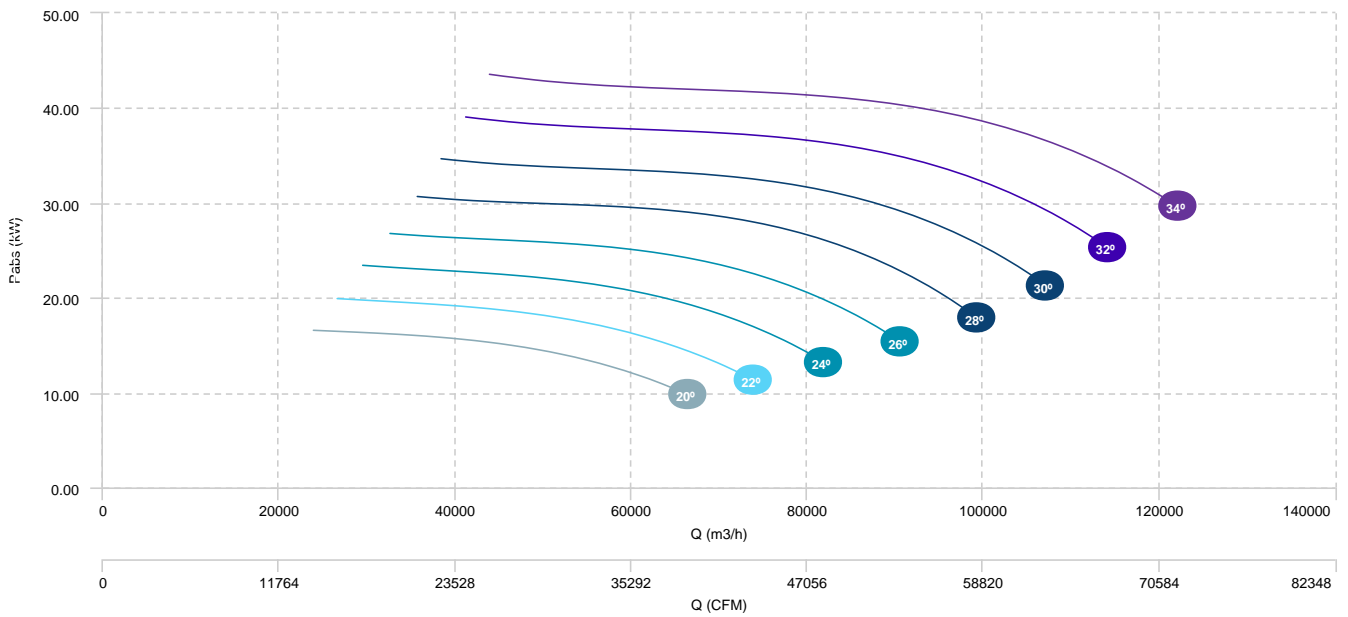



HM 125 T4/T8 15/3,5kW (A7:8)	HM 125 T4/T8 20/5kW (A7:8)	HM 125 T4/T8 28/6,5kW (A7:8)
HM 125 T4/T8 35/8kW (A7:8)	HM 125 T4/T8 37/9,2kW (A7:8)	HM 125 T4/T8 44/11kW (A7:8)

## AIR FLOW - PRESSURE (8 poles)

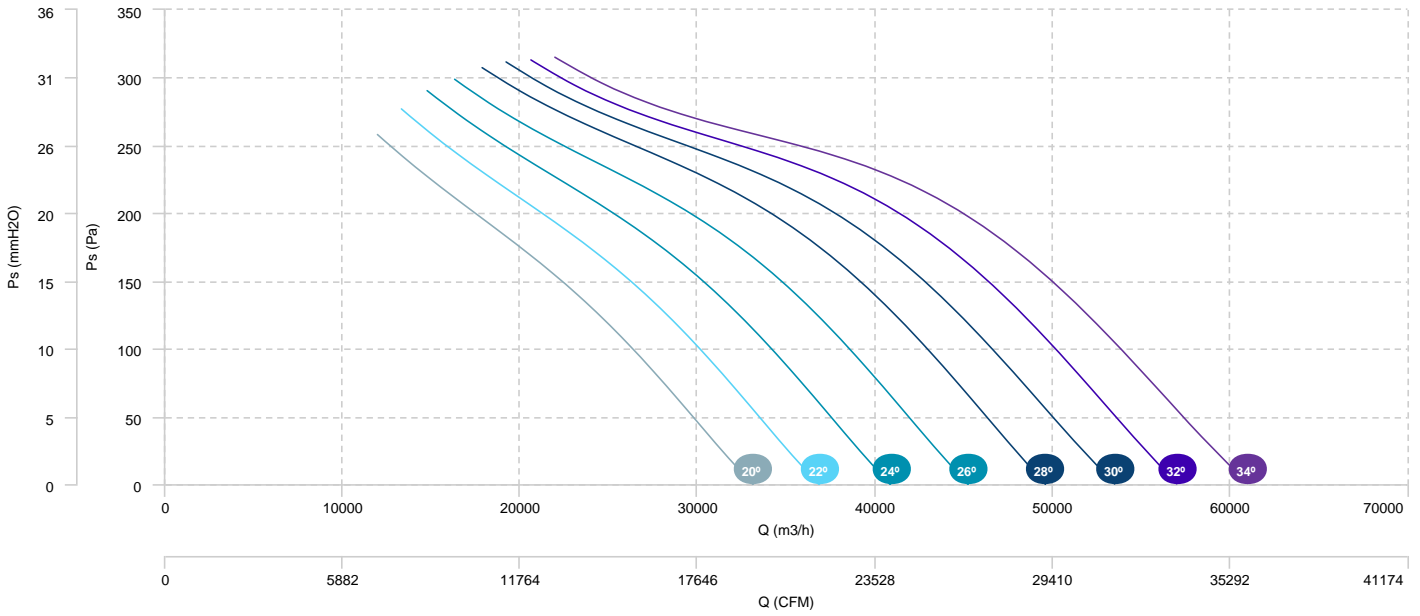

HM 125 T4/T8 11/3kW (A7:4)	HM 125 T4/T8 15/3,5kW (A7:4)	HM 125 T4/T8 17/4,3kW (A7:4)
HM 125 T4/T8 20/5kW (A7:4)	HM 125 T4/T8 28/6,5kW (A7:4)	HM 125 T4/T8 35/8kW (A7:4)

## AIR FLOW - PRESSURE (4 poles)

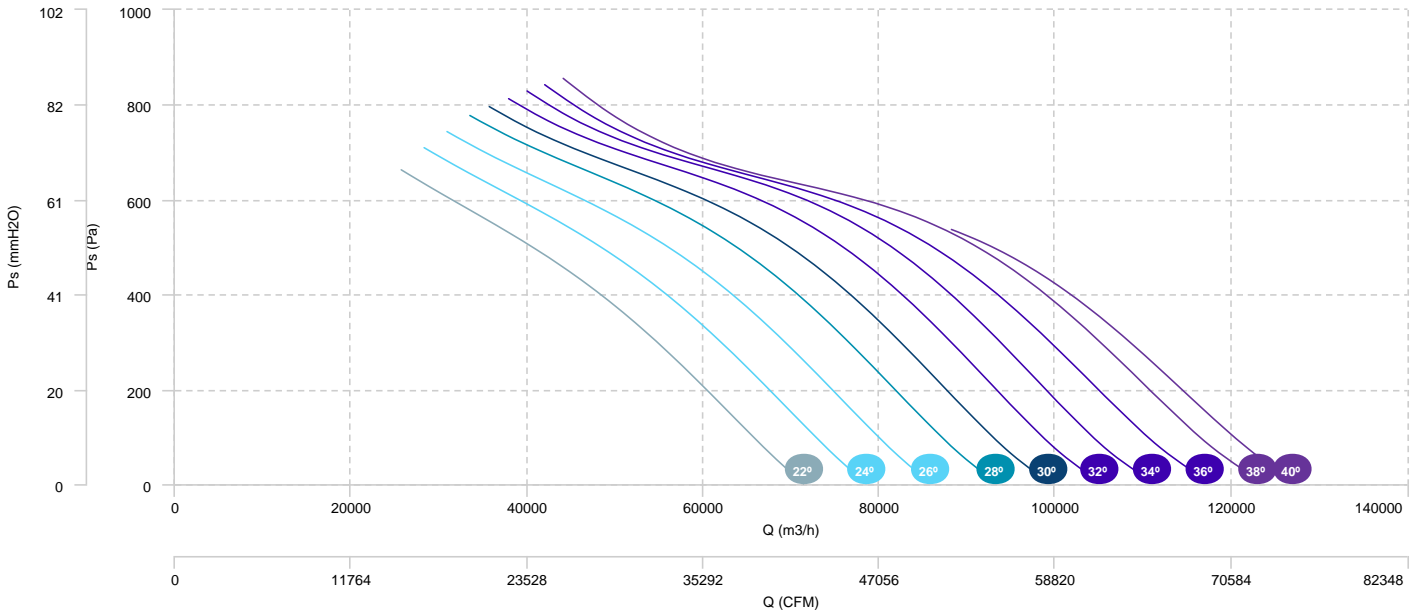

## AIR FLOW - ABSORBED POWER (4 poles)

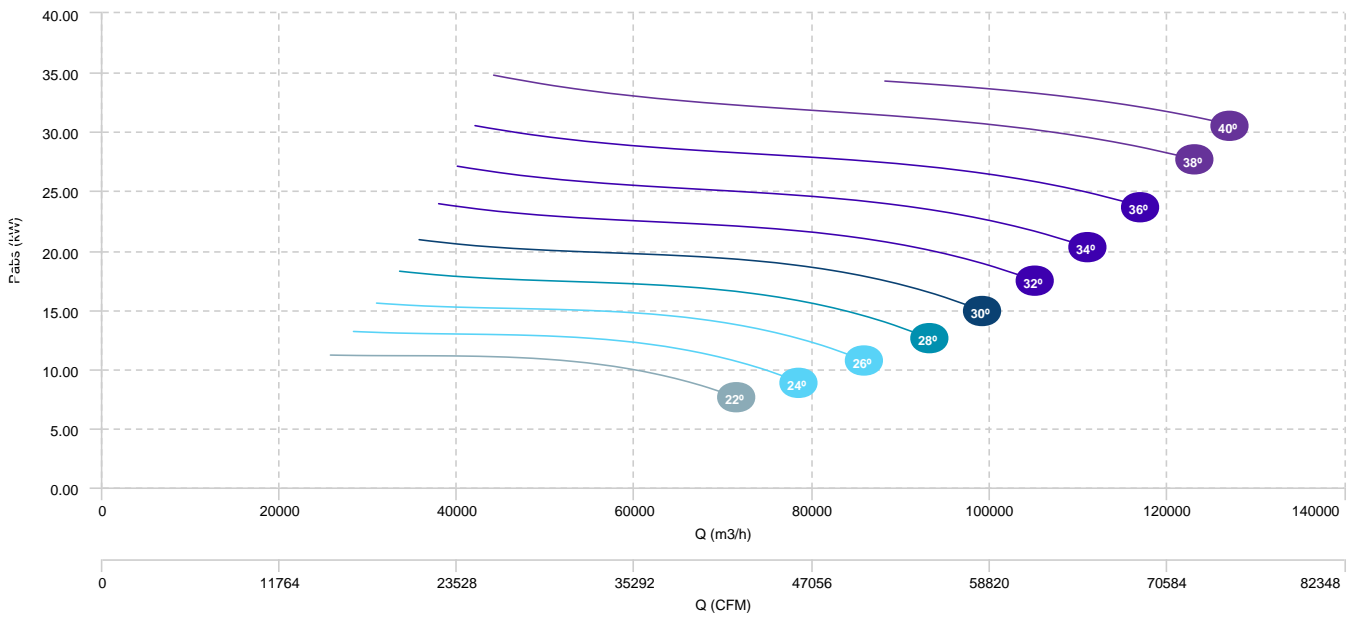

HM 125 T4/T8 11/3kW (A7:4)	HM 125 T4/T8 15/3,5kW (A7:4)	HM 125 T4/T8 17/4,3kW (A7:4)
HM 125 T4/T8 20/5kW (A7:4)	HM 125 T4/T8 28/6,5kW (A7:4)	HM 125 T4/T8 35/8kW (A7:4)

## AIR FLOW - PRESSURE (8 poles)

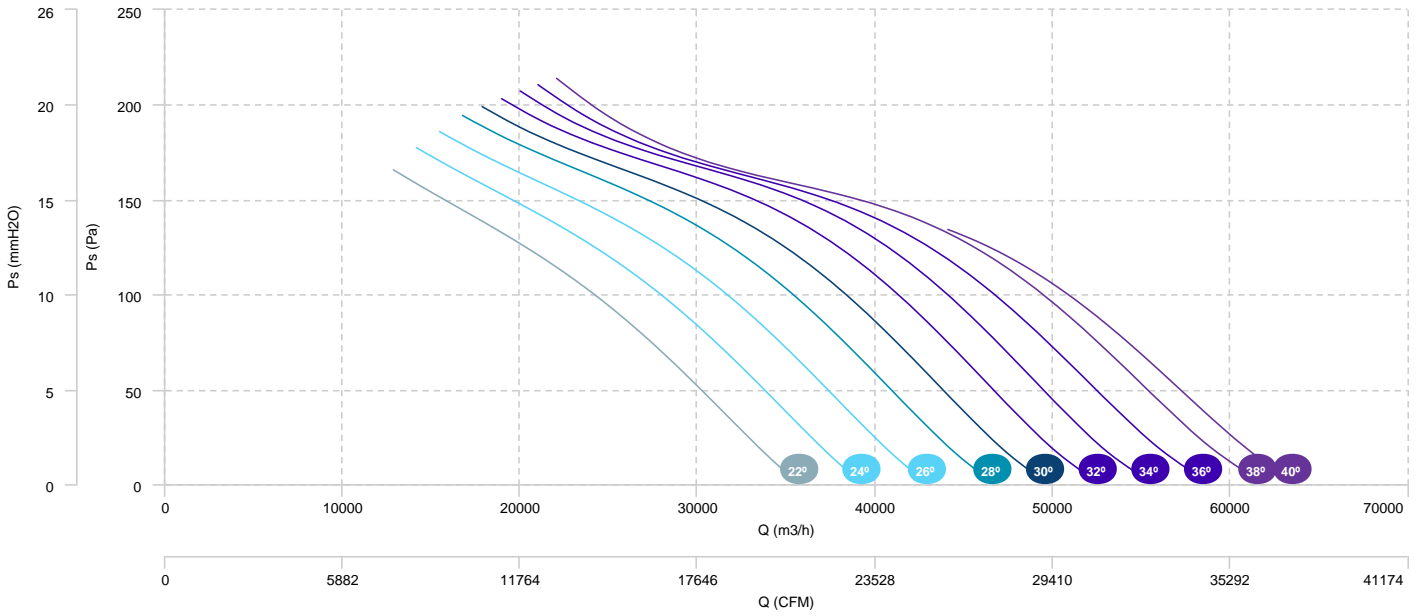

## Sound data

### Sound / 2 poles

		Sound power Lw dB (A)								
Model		63 Hz	125 Hz	250 Hz	500 Hz	1000 Hz	2000 Hz	4000 Hz	8000 Hz	Total
HM 35 M2 0,55kW (A0:6) (30°)	Inlet	56	65	71	77	78	78	80	75	85
HM 35 M2 1,1kW (A0:6) (35°)	Inlet	55	63	70	73	76	76	78	73	83
HM 35 T2 0,55kW (A0:6) (30°)	Inlet	56	65	71	77	78	78	80	75	85
HM 35 T2 1,1kW (A0:6) (35°)	Inlet	55	63	70	73	76	76	78	73	83
HM 40 T2 1,1kW (A0:6) (30°)	Inlet	61	68	73	77	80	82	83	75	87
HM 45 T2 0,75kW (A9:4) (25°)	Inlet	62	71	76	82	85	86	88	83	93
HM 45 T2 1,1kW (A9:4) (30°)	Inlet	60	67	72	76	80	82	83	76	87
HM 45 T2 1,1kW (A9:8) (25°)	Inlet	65	71	78	85	91	94	94	88	98
HM 45 T2 1,5kW (A0:6) (25°)	Inlet	62	71	76	83	88	88	89	85	94
HM 45 T2 1,5kW (A9:4) (35°)	Inlet	60	67	72	76	79	81	82	74	87
HM 45 T2 1,5kW (A9:8) (30°)	Inlet	62	67	74	79	85	87	88	81	92
HM 45 T2 2,2kW (A0:6) (35°)	Inlet	62	69	74	79	82	82	84	78	89
HM 45 T2 2,2kW (A9:4) (45°)	Inlet	63	70	75	80	83	84	84	78	90
HM 45 T2 2,2kW (A9:4) (40°)	Inlet	61	68	73	77	79	82	82	75	87
HM 45 T2 2,2kW (A9:8) (35°)	Inlet	63	69	75	80	83	85	85	77	90
HM 45 T2 3kW (A9:4) (50°)	Inlet	63	70	75	82	86	86	86	80	92
HM 45 T2 3kW (A9:8) (40°)	Inlet	62	69	74	78	81	83	82	75	88
HM 50 T2 1,1kW (A9:4) (25°)	Inlet	66	73	80	88	93	92	92	87	98
HM 50 T2 1,5kW (A9:4) (30°)	Inlet	64	71	76	82	87	86	87	80	92
HM 50 T2 1,5kW (A9:8) (25°)	Inlet	64	73	79	87	92	92	92	85	98
HM 50 T2 2,2kW (A9:4) (40°)	Inlet	64	71	76	80	83	84	84	77	89
HM 50 T2 2,2kW (A9:4) (35°)	Inlet	64	71	76	80	83	84	85	77	90
HM 50 T2 2,2kW (A9:8) (30°)	Inlet	64	71	76	82	87	88	89	80	93
HM 50 T2 3kW (A9:4) (45°)	Inlet	66	73	78	81	84	85	85	79	91
HM 50 T2 3kW (A9:8) (35°)	Inlet	65	72	77	82	85	88	86	79	92
HM 50 T2 4kW (A9:4) (50°)	Inlet	67	74	79	84	87	88	87	82	94
HM 50 T2 4kW (A9:8) (40°)	Inlet	65	72	77	81	84	86	85	78	91
HM 56 T2 1,5kW (A9:4) (25°)	Inlet	67	73	80	88	93	92	92	87	98
HM 56 T2 2,2kW (A9:4) (30°)	Inlet	65	72	77	83	88	87	88	81	93
HM 56 T2 2,2kW (A9:8) (25°)	Inlet	65	74	80	87	93	93	93	86	99
HM 56 T2 3kW (A9:4) (40°)	Inlet	65	72	77	81	84	85	85	78	91
HM 56 T2 3kW (A9:4) (35°)	Inlet	65	72	77	82	85	85	87	79	91
HM 56 T2 3kW (A9:8) (30°)	Inlet	65	72	77	83	88	89	89	81	94
HM 56 T2 4kW (A9:4) (45°)	Inlet	68	75	80	83	86	87	86	80	92
HM 56 T2 4kW (A9:8) (35°)	Inlet	67	74	79	84	87	89	88	81	94
HM 56 T2 5,5kW (A9:5) (45°)	Inlet	92	91	90	89	88	87	88	84	98

Sound power Lw dB (A)										
Model		63 Hz	125 Hz	250 Hz	500 Hz	1000 Hz	2000 Hz	4000 Hz	8000 Hz	Total
HM 56 T2 5,5kW (A9:10) (35°)	Inlet	92	89	87	88	90	90	87	83	98
HM 56 T2 7,5kW (A9:10) (40°)	Inlet	93	90	88	86	87	88	86	81	97
HM 63 T2 1,5kW (A9:4) (25°)	Inlet	66	72	79	87	92	91	91	86	97
HM 63 T2 2,2kW (A9:4) (30°)	Inlet	65	72	77	83	87	87	87	81	93
HM 63 T2 3kW (A9:4) (35°)	Inlet	66	73	78	82	85	86	87	79	92
HM 63 T2 3kW (A9:8) (25°)	Inlet	65	73	80	87	92	93	93	86	98
HM 63 T2 4kW (A9:4) (40°)	Inlet	66	73	78	82	85	86	86	79	92
HM 63 T2 4kW (A9:8) (30°)	Inlet	65	72	77	83	88	89	90	82	95
HM 63 T2 5,5kW (A9:10) (30°)	Inlet	94	91	89	90	90	92	91	84	100
HM 63 T2 7,5kW (A9:5) (40°)	Inlet	93	91	90	89	88	88	89	85	99
HM 63 T2 7,5kW (A9:10) (35°)	Inlet	92	89	87	88	89	89	86	82	98
HM 63 T2 11kW (A9:5) (50°)	Inlet	95	94	92	91	91	91	90	88	102
HM 63 T2 11kW (A9:5) (45°)	Inlet	94	92	91	90	89	88	89	85	99
HM 63 T2 11kW (A9:10) (40°)	Inlet	95	92	90	88	90	90	88	83	100
HM 63 T2 15kW (A9:10) (45°)	Inlet	99	96	94	90	91	91	88	84	103

## Sound / 4 poles

Sound power Lw dB (A)										
Model		63 Hz	125 Hz	250 Hz	500 Hz	1000 Hz	2000 Hz	4000 Hz	8000 Hz	Total
HM 35 M4 0,12kW (A0:6) (40°)	Inlet	40	48	54	59	61	62	63	57	68
HM 35 T4 0,12kW (A0:6) (40°)	Inlet	40	48	54	59	61	62	63	57	68
HM 40 M4 0,25kW (A0:6) (40°)	Inlet	48	55	60	64	67	68	68	62	74
HM 40 T4 0,25kW (A0:6) (40°)	Inlet	48	55	60	64	67	68	68	62	74
HM 45 M4 0,37kW (A0:6) (40°)	Inlet	39	57	69	74	76	70	63	58	79
HM 45 T4 0,55kW (A0:6) (45°)	Inlet	50	57	63	67	69	70	70	64	76
HM 50 M4 0,55kW (A0:6) (40°)	Inlet	51	59	64	68	71	72	72	65	78
HM 50 T4 0,55kW (A0:6) (45°)	Inlet	51	59	64	68	71	72	72	65	78
HM 56 M4 0,37kW (A5:6) (20°)	Inlet	52	60	67	74	80	75	77	69	84
HM 56 M4 0,55kW (A2:6) (25°)	Inlet	50	57	65	73	75	76	77	72	82
HM 56 M4 0,55kW (A2:6) (20°)	Inlet	46	54	64	73	75	75	76	72	82
HM 56 M4 0,55kW (A5:6) (25°)	Inlet	54	62	67	75	79	76	78	70	84
HM 56 T4 0,37kW (A5:6) (20°)	Inlet	52	60	67	74	80	75	77	69	84
HM 56 T4 0,55kW (A2:6) (25°)	Inlet	50	57	65	73	75	76	77	72	82
HM 56 T4 0,55kW (A2:6) (20°)	Inlet	46	54	64	73	75	75	76	72	82
HM 56 T4 0,55kW (A2:9) (20°)	Inlet	54	58	67	73	76	76	77	69	82
HM 56 T4 0,55kW (A5:6) (25°)	Inlet	54	62	67	75	79	76	78	70	84
HM 56 T4 0,75kW (A2:6) (33°)	Inlet	53	60	65	71	73	75	75	70	80
HM 56 T4 0,75kW (A2:6) (30°)	Inlet	52	59	65	71	73	74	76	70	80

**Sound power Lw dB (A)**

Model		63 Hz	125 Hz	250 Hz	500 Hz	1000 Hz	2000 Hz	4000 Hz	8000 Hz	Total
HM 56 T4 0,75kW (A2:6) (28°)	Inlet	51	58	65	72	74	75	76	70	81
HM 56 T4 0,75kW (A2:9) (25°)	Inlet	53	58	67	73	76	76	77	71	82
HM 56 T4 0,75kW (A5:6) (33°)	Inlet	54	61	66	75	75	76	79	70	83
HM 56 T4 0,75kW (A5:6) (30°)	Inlet	56	63	68	77	78	78	80	72	85
HM 56 T4 1,1kW (A2:6) (43°)	Inlet	55	61	67	72	74	76	76	70	81
HM 56 T4 1,1kW (A2:6) (40°)	Inlet	54	61	66	71	74	75	76	70	81
HM 56 T4 1,1kW (A2:6) (37°)	Inlet	53	60	65	71	73	75	76	70	81
HM 56 T4 1,1kW (A2:6) (35°)	Inlet	52	59	64	71	73	75	75	70	80
HM 56 T4 1,1kW (A2:9) (35°)	Inlet	53	59	68	73	76	77	79	73	83
HM 56 T4 1,1kW (A2:9) (33°)	Inlet	53	59	68	73	76	77	78	73	83
HM 56 T4 1,1kW (A2:9) (30°)	Inlet	54	59	67	73	77	77	78	73	83
HM 56 T4 1,1kW (A2:9) (28°)	Inlet	54	59	67	73	76	77	78	72	83
HM 56 T4 1,1kW (A5:6) (37°)	Inlet	54	61	66	75	74	76	78	69	82
HM 56 T4 1,1kW (A5:6) (35°)	Inlet	53	60	65	74	73	75	78	69	82
HM 56 T4 1,5kW (A2:6) (45°)	Inlet	56	60	68	72	75	77	76	71	82
HM 56 T4 1,5kW (A2:9) (43°)	Inlet	53	60	69	73	76	77	78	72	83
HM 56 T4 1,5kW (A2:9) (40°)	Inlet	53	60	69	73	76	77	78	72	83
HM 56 T4 1,5kW (A2:9) (37°)	Inlet	53	59	68	73	76	77	78	73	83
HM 56 T4 1,5kW (A5:6) (40°)	Inlet	56	63	68	76	75	76	79	70	83
HM 63 T4 0,55kW (A2:6) (20°)	Inlet	49	51	64	74	73	73	75	70	80
HM 63 T4 0,75kW (A2:6) (25°)	Inlet	53	58	67	75	76	77	78	73	83
HM 63 T4 0,75kW (A2:9) (20°)	Inlet	57	60	71	77	78	77	79	74	85
HM 63 T4 0,75kW (A5:6) (25°)	Inlet	57	66	71	80	80	79	80	75	86
HM 63 T4 1,1kW (A2:6) (33°)	Inlet	53	61	66	73	75	77	77	72	82
HM 63 T4 1,1kW (A2:6) (30°)	Inlet	53	60	66	74	75	77	78	73	83
HM 63 T4 1,1kW (A2:6) (28°)	Inlet	53	59	67	74	76	77	78	73	83
HM 63 T4 1,1kW (A2:9) (25°)	Inlet	57	61	70	76	78	78	80	74	85
HM 63 T4 1,1kW (A5:6) (30°)	Inlet	60	68	74	80	80	79	82	77	87
HM 63 T4 1,5kW (A2:6) (40°)	Inlet	55	62	67	73	76	77	77	72	83
HM 63 T4 1,5kW (A2:6) (37°)	Inlet	54	61	66	73	75	77	77	72	82
HM 63 T4 1,5kW (A2:6) (35°)	Inlet	53	60	65	72	74	77	77	72	82
HM 63 T4 1,5kW (A2:9) (33°)	Inlet	57	63	70	77	79	80	81	75	86
HM 63 T4 1,5kW (A2:9) (30°)	Inlet	58	63	70	76	78	80	81	75	86
HM 63 T4 1,5kW (A2:9) (28°)	Inlet	58	62	70	76	78	79	80	75	85
HM 63 T4 1,5kW (A5:6) (35°)	Inlet	59	67	72	75	76	76	79	73	83
HM 63 T4 1,5kW (A5:6) (33°)	Inlet	59	68	73	77	78	77	80	75	85
HM 63 T4 2,2kW (A2:6) (45°)	Inlet	58	62	70	74	78	78	78	72	84
HM 63 T4 2,2kW (A2:6) (43°)	Inlet	56	62	68	74	76	78	78	72	83
HM 63 T4 2,2kW (A2:9) (43°)	Inlet	57	64	69	76	79	80	81	76	86

**Sound power Lw dB (A)**

Model		63 Hz	125 Hz	250 Hz	500 Hz	1000 Hz	2000 Hz	4000 Hz	8000 Hz	Total
HM 63 T4 2,2kW (A2:9) (40°)	Inlet	57	63	69	76	79	80	80	76	86
HM 63 T4 2,2kW (A2:9) (37°)	Inlet	57	63	70	76	79	80	81	76	86
HM 63 T4 2,2kW (A2:9) (35°)	Inlet	57	63	70	77	79	80	81	76	86
HM 63 T4 2,2kW (A5:6) (37°)	Inlet	59	67	72	76	77	77	79	73	84
HM 63 T4 2,2kW (A5:6) (40°)	Inlet	60	67	72	77	78	78	80	73	85
HM 63 T4 3kW (A2:9) (45°)	Inlet	57	64	69	76	78	80	81	75	86
HM 71 T4 0,75KW (A2:6) (20°)	Inlet	55	61	72	79	83	82	84	78	89
HM 71 T4 0,75kW (A5:6) (20°)	Inlet	55	66	71	86	85	82	84	76	91
HM 71 T4 1,1kW (A2:6) (25°)	Inlet	57	63	71	79	81	82	83	77	88
HM 71 T4 1,1kW (A2:9) (20°)	Inlet	60	66	75	83	85	85	87	79	91
HM 71 T4 1,1kW (A5:6) (25°)	Inlet	59	67	72	84	84	82	84	75	90
HM 71 T4 1,5kW (A2:6) (33°)	Inlet	57	64	69	76	78	80	81	75	86
HM 71 T4 1,5kW (A2:6) (30°)	Inlet	58	64	70	78	79	81	82	77	87
HM 71 T4 1,5kW (A2:6) (28°)	Inlet	57	64	70	78	80	81	82	77	87
HM 71 T4 1,5kW (A2:9) (25°)	Inlet	60	67	74	81	83	84	85	79	90
HM 71 T4 1,5kW (A5:6) (30°)	Inlet	61	68	73	82	82	83	84	73	89
HM 71 T4 2,2kW (A2:6) (40°)	Inlet	59	66	71	77	80	81	80	74	86
HM 71 T4 2,2kW (A2:6) (37°)	Inlet	58	65	70	76	78	80	80	74	85
HM 71 T4 2,2kW (A2:6) (35°)	Inlet	57	64	69	75	77	79	80	74	85
HM 71 T4 2,2kW (A2:9) (33°)	Inlet	60	67	72	79	82	83	83	78	89
HM 71 T4 2,2kW (A2:9) (30°)	Inlet	60	67	72	79	82	83	84	78	89
HM 71 T4 2,2kW (A2:9) (28°)	Inlet	60	67	73	80	82	83	84	78	89
HM 71 T4 2,2kW (A5:6) (35°)	Inlet	62	69	74	76	80	82	83	72	87
HM 71 T4 2,2kW (A5:6) (33°)	Inlet	62	69	74	79	81	83	84	73	88
HM 71 T4 3kW (A2:6) (45°)	Inlet	62	66	74	77	80	81	81	74	86
HM 71 T4 3kW (A2:6) (43°)	Inlet	60	66	72	77	80	81	80	74	86
HM 71 T4 3kW (A2:9) (37°)	Inlet	61	68	73	79	82	83	83	78	89
HM 71 T4 3kW (A2:9) (35°)	Inlet	60	67	72	79	82	83	83	78	89
HM 71 T4 3kW (A5:6) (40°)	Inlet	67	73	79	81	84	85	86	76	91
HM 71 T4 3kW (A5:6) (37°)	Inlet	65	71	77	79	82	84	85	74	89
HM 80 T4 1,1KW (A2:6) (20°)	Inlet	54	61	71	79	83	83	84	79	89
HM 80 T4 1,5KW (A2:6) (25°)	Inlet	57	64	72	79	83	83	84	79	89
HM 80 T4 1,5KW (A2:9) (20°)	Inlet	60	72	77	89	91	89	92	84	97
HM 80 T4 2,2kW (A2:6) (33°)	Inlet	61	68	73	79	82	84	84	77	89
HM 80 T4 2,2kW (A2:6) (30°)	Inlet	60	67	72	79	82	84	84	78	89
HM 80 T4 2,2kW (A2:6) (28°)	Inlet	60	67	72	79	82	84	84	78	89
HM 80 T4 2,2kW (A2:9) (25°)	Inlet	62	71	76	86	89	88	90	83	95
HM 80 T4 3kW (A2:6) (37°)	Inlet	62	69	74	78	81	83	83	76	88
HM 80 T4 3kW (A2:6) (35°)	Inlet	62	69	74	78	81	84	84	77	89

**Sound power Lw dB (A)**

Model		63 Hz	125 Hz	250 Hz	500 Hz	1000 Hz	2000 Hz	4000 Hz	8000 Hz	Total
HM 80 T4 3kW (A2:9) (30°)	Inlet	63	70	75	84	87	88	88	82	93
HM 80 T4 3kW (A2:9) (28°)	Inlet	63	71	76	85	88	88	89	82	94
HM 80 T4 3kW (A5:6) (35°)	Inlet	62	69	74	79	82	82	86	76	89
HM 80 T4 3kW (A5:6) (33°)	Inlet	63	70	75	81	85	84	88	80	91
HM 80 T4 3kW (A5:6) (30°)	Inlet	64	71	76	83	87	86	90	83	94
HM 80 T4 4kW (A2:6) (43°)	Inlet	62	69	75	78	81	82	82	75	88
HM 80 T4 4kW (A2:6) (40°)	Inlet	61	69	74	78	81	82	82	75	88
HM 80 T4 4kW (A2:9) (35°)	Inlet	62	69	74	81	85	87	86	80	92
HM 80 T4 4kW (A2:9) (33°)	Inlet	63	70	75	83	86	87	87	81	93
HM 80 T4 4kW (A5:6) (37°)	Inlet	64	71	76	80	83	83	86	76	90
HM 80 T4 4kW (A5:6) (40°)	Inlet	66	73	78	82	84	84	86	76	91
HM 80 T4 5,5kW (A2:6) (45°)	Inlet	62	69	75	79	82	82	82	75	88
HM 80 T4 5,5kW (A2:9) (43°)	Inlet	64	71	76	81	84	86	85	79	91
HM 80 T4 5,5kW (A2:9) (40°)	Inlet	64	71	76	81	84	86	85	79	91
HM 80 T4 5,5kW (A2:9) (37°)	Inlet	63	70	75	81	85	87	86	80	91
HM 90 T4 3kW (A6:3) (22°)	Inlet	61	65	73	77	81	82	85	79	89
HM 90 T4 3kW (A6:3) (20°)	Inlet	60	63	72	75	79	80	84	78	87
HM 90 T4 4kW (A6:3) (28°)	Inlet	64	69	77	82	84	85	87	82	92
HM 90 T4 4kW (A6:3) (26°)	Inlet	63	68	76	81	83	84	87	81	91
HM 90 T4 4kW (A6:3) (24°)	Inlet	62	67	75	79	82	83	86	80	90
HM 90 T4 5,5kW (A6:3) (32°)	Inlet	65	71	78	86	86	87	88	83	94
HM 90 T4 5,5kW (A6:3) (30°)	Inlet	65	71	78	84	85	86	88	82	93
HM 90 T4 5,5kW (A6:6) (22°)	Inlet	66	75	81	89	92	91	91	86	97
HM 90 T4 5,5kW (A6:6) (20°)	Inlet	65	75	81	88	92	90	91	86	97
HM 90 T4 7,5kW (A6:3) (36°)	Inlet	66	72	79	88	87	89	89	84	95
HM 90 T4 7,5kW (A6:3) (34°)	Inlet	66	72	79	87	87	88	89	83	94
HM 90 T4 7,5kW (A6:6) (28°)	Inlet	68	77	83	90	92	92	93	88	98
HM 90 T4 7,5kW (A6:6) (26°)	Inlet	67	77	82	90	92	91	92	88	98
HM 90 T4 7,5kW (A6:6) (24°)	Inlet	67	76	82	89	92	91	92	87	98
HM 90 T4 11kW (A6:3) (40°)	Inlet	66	74	81	89	90	91	91	86	97
HM 90 T4 11kW (A6:3) (38°)	Inlet	66	73	80	89	89	90	90	85	96
HM 90 T4 11kW (A6:6) (34°)	Inlet	66	75	80	87	88	89	91	85	95
HM 90 T4 11kW (A6:6) (32°)	Inlet	68	77	82	89	90	90	92	87	97
HM 90 T4 11kW (A6:6) (30°)	Inlet	69	78	83	90	92	92	93	89	99
HM 90 T4 15kW (A6:6) (40°)	Inlet	68	76	81	88	89	90	91	85	96
HM 90 T4 15kW (A6:6) (38°)	Inlet	67	76	81	87	88	89	91	85	96
HM 90 T4 15kW (A6:6) (36°)	Inlet	66	75	80	86	88	89	90	85	95
HM 100 T4 5,5kW (A6:3) (26°)	Inlet	66	72	78	83	87	88	91	84	94
HM 100 T4 5,5kW (A6:3) (24°)	Inlet	66	72	78	83	87	88	91	85	95



**Sound power Lw dB (A)**

Model		63 Hz	125 Hz	250 Hz	500 Hz	1000 Hz	2000 Hz	4000 Hz	8000 Hz	Total
HM 100 T4 5,5kW (A6:3) (22°)	Inlet	64	71	76	81	87	88	92	84	95
HM 100 T4 5,5kW (A6:3) (20°)	Inlet	64	71	76	81	87	88	92	84	95
HM 100 T4 7,5kW (A6:3) (30°)	Inlet	66	72	78	84	86	87	89	83	94
HM 100 T4 7,5kW (A6:3) (28°)	Inlet	66	72	78	83	86	88	90	84	94
HM 100 T4 7,5kW (A6:6) (22°)	Inlet	69	80	85	95	95	95	95	91	102
HM 100 T4 7,5kW (A6:6) (20°)	Inlet	69	80	85	95	96	95	95	91	102
HM 100 T4 11kW (A6:3) (36°)	Inlet	69	75	82	88	90	90	91	86	96
HM 100 T4 11kW (A6:3) (34°)	Inlet	69	75	81	87	89	90	90	85	96
HM 100 T4 11kW (A6:3) (32°)	Inlet	68	73	80	85	87	88	90	84	95
HM 100 T4 11kW (A6:6) (28°)	Inlet	73	81	87	95	95	95	96	92	103
HM 100 T4 11kW (A6:6) (26°)	Inlet	71	81	86	94	95	95	96	91	102
HM 100 T4 11kW (A6:6) (24°)	Inlet	70	80	85	94	95	95	95	91	102
HM 100 T4 15kW (A6:3) (40°)	Inlet	69	77	82	90	91	92	92	87	98
HM 100 T4 15kW (A6:3) (38°)	Inlet	69	76	82	89	90	91	91	86	97
HM 100 T4 15kW (A6:6) (32°)	Inlet	72	80	86	92	94	94	95	90	101
HM 100 T4 15kW (A6:6) (30°)	Inlet	73	81	87	94	95	95	97	92	102
HM 100 T4 18,5kW (A6:6) (36°)	Inlet	71	79	85	89	92	92	94	88	99
HM 100 T4 18,5kW (A6:6) (34°)	Inlet	72	80	86	90	92	93	94	89	99
HM 100 T4 22kW (A6:6) (40°)	Inlet	73	81	86	91	93	94	95	89	101
HM 100 T4 22kW (A6:6) (38°)	Inlet	72	80	86	90	92	93	94	89	99
HM 112 T4 5,5kW (A6:3) (22°)	Inlet	69	76	81	87	92	93	95	90	99
HM 112 T4 5,5kW (A6:3) (20°)	Inlet	67	74	79	86	91	92	94	89	99
HM 112 T4 7,5kW (A6:3) (26°)	Inlet	71	77	83	89	92	93	96	90	100
HM 112 T4 7,5kW (A6:3) (24°)	Inlet	70	77	82	88	92	93	95	90	100
HM 112 T4 11kW (A6:3) (30°)	Inlet	71	77	83	89	92	92	95	90	99
HM 112 T4 11kW (A6:3) (28°)	Inlet	71	77	83	89	92	93	95	90	100
HM 112 T4 11kW (A6:6) (22°)	Inlet	70	80	86	96	98	97	98	93	104
HM 112 T4 11kW (A6:6) (20°)	Inlet	69	80	86	97	98	97	98	93	104
HM 112 T4 15kW (A6:3) (36°)	Inlet	73	78	85	90	92	93	94	90	99
HM 112 T4 15kW (A6:3) (34°)	Inlet	73	77	85	90	92	92	94	90	99
HM 112 T4 15kW (A6:3) (32°)	Inlet	72	77	84	89	92	92	94	90	99
HM 112 T4 15kW (A6:6) (28°)	Inlet	74	82	87	95	97	97	98	92	104
HM 112 T4 15kW (A6:6) (26°)	Inlet	72	81	86	95	97	97	98	92	104
HM 112 T4 15kW (A6:6) (24°)	Inlet	71	80	86	95	97	96	97	92	103
HM 112 T4 18,5kW (A6:3) (38°)	Inlet	73	79	85	91	93	93	94	90	100
HM 112 T4 18,5kW (A6:6) (30°)	Inlet	75	82	87	94	96	97	98	91	103
HM 112 T4 22kW (A6:3) (40°)	Inlet	73	79	85	91	93	94	94	90	100
HM 112 T4 22kW (A6:6) (34°)	Inlet	74	81	86	91	94	95	96	89	101
HM 112 T4 22kW (A6:6) (32°)	Inlet	74	81	86	92	95	96	97	90	102

Sound power Lw dB (A)										
Model		63 Hz	125 Hz	250 Hz	500 Hz	1000 Hz	2000 Hz	4000 Hz	8000 Hz	Total
HM 112 T4 30kW (A6:6) (40°)	Inlet	78	85	90	94	97	98	99	92	104
HM 112 T4 30kW (A6:6) (38°)	Inlet	77	83	89	92	96	97	98	91	103
HM 112 T4 30kW (A6:6) (36°)	Inlet	75	82	87	91	94	95	96	89	102
HM 125 T4 11kW (A7:4) (22°)	Inlet	75	86	91	98	102	103	105	101	109
HM 125 T4 11kW (A7:4) (20°)	Inlet	72	85	90	98	102	102	104	101	109
HM 125 T4 15kW (A7:4) (26°)	Inlet	76	84	89	94	98	99	101	95	106
HM 125 T4 15kW (A7:4) (24°)	Inlet	75	85	90	96	100	101	103	98	107
HM 125 T4 15kW (A7:8) (20°)	Inlet	77	85	92	101	107	110	109	104	115
HM 125 T4 18,5kW (A7:4) (30°)	Inlet	74	81	86	90	94	96	97	90	102
HM 125 T4 18,5kW (A7:4) (28°)	Inlet	75	82	87	92	96	98	99	93	104
HM 125 T4 18,5kW (A7:8) (22°)	Inlet	77	85	91	99	106	109	108	103	113
HM 125 T4 22kW (A7:4) (32°)	Inlet	74	81	86	90	93	95	96	89	101
HM 125 T4 22kW (A7:8) (24°)	Inlet	77	84	91	98	105	107	107	101	112
HM 125 T4 30kW (A7:4) (36°)	Inlet	74	81	86	90	93	95	96	88	101
HM 125 T4 30kW (A7:4) (34°)	Inlet	73	80	85	90	93	95	96	88	101
HM 125 T4 30kW (A7:8) (28°)	Inlet	77	83	90	96	102	105	105	98	110
HM 125 T4 30kW (A7:8) (26°)	Inlet	77	84	90	97	103	106	106	99	111
HM 125 T4 37kW (A7:4) (40°)	Inlet	75	82	87	92	94	96	96	90	102
HM 125 T4 37kW (A7:4) (38°)	Inlet	75	82	87	91	94	96	96	89	102
HM 125 T4 37kW (A7:8) (32°)	Inlet	77	83	89	94	99	101	102	94	106
HM 125 T4 37kW (A7:8) (30°)	Inlet	77	83	89	95	100	103	103	96	108
HM 125 T4 45kW (A7:8) (36°)	Inlet	77	84	89	94	97	99	99	91	105
HM 125 T4 45kW (A7:8) (34°)	Inlet	77	83	89	94	98	100	100	92	105

## Sound / 6 poles

Sound power Lw dB (A)										
Model		63 Hz	125 Hz	250 Hz	500 Hz	1000 Hz	2000 Hz	4000 Hz	8000 Hz	Total
HM 40 M6 0,04kW (A0:6) (35°)	Inlet	35	42	48	51	54	56	57	50	62
HM 40 T6 0,12kW (A0:6) (35°)	Inlet	35	42	48	51	54	56	57	50	62
HM 45 M6 0,13kW (A0:6) (45°)	Inlet	41	48	53	57	60	61	61	54	67
HM 45 T6 0,13kW (A0:6) (45°)	Inlet	41	48	53	57	60	61	61	54	67
HM 50 M6 0,13kW (A0:6) (45°)	Inlet	42	49	55	59	62	62	62	56	69
HM 50 T6 0,13kW (A0:6) (45°)	Inlet	42	49	55	59	62	62	62	56	69
HM 56 M6 0,25kW (A2:6) (35°)	Inlet	43	50	55	61	63	65	66	61	71
HM 56 M6 0,25kW (A2:6) (37°)	Inlet	44	51	56	62	64	66	66	60	71
HM 56 M6 0,25kW (A2:6) (33°)	Inlet	43	50	55	61	63	65	66	61	71
HM 56 M6 0,25kW (A2:6) (30°)	Inlet	42	49	55	61	64	65	66	60	71
HM 56 M6 0,25kW (A2:6) (28°)	Inlet	42	49	56	62	64	65	66	61	71

**Sound power Lw dB (A)**

Model		63 Hz	125 Hz	250 Hz	500 Hz	1000 Hz	2000 Hz	4000 Hz	8000 Hz	Total
HM 56 M6 0,25kW (A2:6) (25°)	Inlet	40	48	56	64	66	66	67	62	73
HM 56 M6 0,25kW (A2:6) (20°)	Inlet	37	45	54	64	65	66	67	62	72
HM 56 M6 0,25kW (A5:6) (35°)	Inlet	44	51	56	65	64	66	69	60	73
HM 56 M6 0,25kW (A5:6) (33°)	Inlet	46	53	58	67	66	67	70	62	74
HM 56 M6 0,25kW (A5:6) (30°)	Inlet	47	54	59	68	69	69	71	63	76
HM 56 M6 0,37kW (A2:6) (45°)	Inlet	47	50	59	63	66	67	67	61	72
HM 56 M6 0,37kW (A2:6) (43°)	Inlet	45	51	57	62	65	66	67	60	72
HM 56 M6 0,37kW (A2:6) (40°)	Inlet	45	52	57	62	64	66	67	60	72
HM 56 M6 0,37kW (A5:6) (37°)	Inlet	46	53	58	66	65	67	69	61	73
HM 56 M6 0,37kW (A5:6) (40°)	Inlet	47	54	59	67	66	67	70	61	74
HM 56 T6 0,25kW (A5:6) (35°)	Inlet	44	51	56	65	64	66	69	60	73
HM 56 T6 0,25kW (A5:6) (33°)	Inlet	46	53	58	67	66	67	70	62	74
HM 56 T6 0,25kW (A5:6) (30°)	Inlet	47	54	59	68	69	69	71	63	76
HM 56 T6 0,37kW (A5:6) (37°)	Inlet	46	53	58	66	65	67	69	61	73
HM 56 T6 0,37kW (A5:6) (40°)	Inlet	47	54	59	67	66	67	70	61	74
HM 56 T6 0,55kW (A2:6) (20°)	Inlet	37	45	54	64	65	66	67	62	72
HM 56 T6 0,55kW (A2:6) (25°)	Inlet	40	48	56	64	66	66	67	62	73
HM 56 T6 0,55kW (A2:6) (28°)	Inlet	42	49	56	62	64	65	66	61	71
HM 56 T6 0,55kW (A2:6) (30°)	Inlet	42	49	55	61	64	65	66	60	71
HM 56 T6 0,55kW (A2:6) (33°)	Inlet	43	50	55	61	63	65	66	61	71
HM 56 T6 0,55kW (A2:6) (35°)	Inlet	43	50	55	61	63	65	66	61	71
HM 56 T6 0,55kW (A2:6) (37°)	Inlet	44	51	56	62	64	66	66	60	71
HM 56 T6 0,55kW (A2:6) (40°)	Inlet	45	52	57	62	64	66	67	60	72
HM 56 T6 0,55kW (A2:6) (43°)	Inlet	45	51	57	62	65	66	67	60	72
HM 56 T6 0,55kW (A2:6) (45°)	Inlet	47	50	59	63	66	67	67	61	72
HM 56 T6 0,55kW (A2:9) (30°)	Inlet	44	50	58	64	67	68	69	63	74
HM 56 T6 0,55kW (A2:9) (28°)	Inlet	44	49	58	64	67	67	68	63	74
HM 56 T6 0,55kW (A2:9) (25°)	Inlet	44	49	57	64	67	67	68	61	73
HM 56 T6 0,55kW (A2:9) (20°)	Inlet	44	49	57	64	67	67	67	60	73
HM 56 T6 0,55kW (A2:9) (40°)	Inlet	44	50	59	63	67	67	68	63	73
HM 56 T6 0,55kW (A2:9) (37°)	Inlet	43	50	59	64	67	67	69	63	74
HM 56 T6 0,55kW (A2:9) (35°)	Inlet	43	49	58	64	67	68	69	63	74
HM 56 T6 0,55kW (A2:9) (33°)	Inlet	44	49	58	64	67	68	69	63	74
HM 56 T6 0,55kW (A2:9) (45°)	Inlet	44	51	61	64	67	68	68	63	74
HM 56 T6 0,55kW (A2:9) (43°)	Inlet	44	50	60	63	67	67	68	63	74
HM 63 M6 0,37kW (A5:6) (35°)	Inlet	50	58	63	66	67	67	70	64	75
HM 63 M6 0,55kW (A2:9) (37°)	Inlet	48	54	60	67	69	71	71	66	76
HM 63 M6 0,55kW (A2:9) (35°)	Inlet	47	54	61	67	69	71	72	66	77
HM 63 M6 0,55kW (A2:9) (33°)	Inlet	48	53	61	67	69	70	71	66	76

**Sound power Lw dB (A)**

Model		63 Hz	125 Hz	250 Hz	500 Hz	1000 Hz	2000 Hz	4000 Hz	8000 Hz	Total
HM 63 M6 0,55kW (A2:9) (30°)	Inlet	48	53	60	67	69	70	71	66	76
HM 63 M6 0,55kW (A2:9) (28°)	Inlet	48	53	60	67	69	70	71	66	76
HM 63 M6 0,55kW (A2:9) (25°)	Inlet	48	51	60	67	69	69	70	65	75
HM 63 M6 0,55kW (A2:9) (20°)	Inlet	48	50	61	67	69	68	70	65	75
HM 63 M6 0,55kW (A5:6) (37°)	Inlet	50	58	63	67	68	68	71	64	75
HM 63 M6 0,55kW (A5:6) (40°)	Inlet	51	58	63	68	69	69	71	64	76
HM 63 T6 0,37kW (A5:6) (35°)	Inlet	50	58	63	66	67	67	70	64	75
HM 63 T6 0,55kW (A2:6) (45°)	Inlet	49	53	61	65	68	69	69	63	75
HM 63 T6 0,55kW (A2:6) (43°)	Inlet	47	52	59	64	67	68	68	63	74
HM 63 T6 0,55kW (A2:6) (40°)	Inlet	46	52	58	64	66	68	68	62	73
HM 63 T6 0,55kW (A2:6) (37°)	Inlet	45	52	57	63	66	68	68	62	73
HM 63 T6 0,55kW (A2:6) (35°)	Inlet	44	51	56	63	65	67	68	62	73
HM 63 T6 0,55kW (A2:6) (33°)	Inlet	44	51	56	64	65	68	68	63	73
HM 63 T6 0,55kW (A2:6) (30°)	Inlet	44	51	57	64	66	68	68	64	73
HM 63 T6 0,55kW (A2:6) (28°)	Inlet	44	50	57	65	66	68	68	64	74
HM 63 T6 0,55kW (A2:6) (25°)	Inlet	43	48	58	66	67	68	69	64	74
HM 63 T6 0,55kW (A2:6) (20°)	Inlet	39	42	54	64	64	64	66	60	71
HM 63 T6 0,55kW (A2:9) (37°)	Inlet	48	54	60	67	69	71	71	66	76
HM 63 T6 0,55kW (A2:9) (35°)	Inlet	47	54	61	67	69	71	72	66	77
HM 63 T6 0,55kW (A2:9) (33°)	Inlet	48	53	61	67	69	70	71	66	76
HM 63 T6 0,55kW (A2:9) (30°)	Inlet	48	53	60	67	69	70	71	66	76
HM 63 T6 0,55kW (A2:9) (28°)	Inlet	48	53	60	67	69	70	71	66	76
HM 63 T6 0,55kW (A2:9) (25°)	Inlet	48	51	60	67	69	69	70	65	75
HM 63 T6 0,55kW (A2:9) (20°)	Inlet	48	50	61	67	69	68	70	65	75
HM 63 T6 0,55kW (A5:6) (37°)	Inlet	50	58	63	67	68	68	71	64	75
HM 63 T6 0,55kW (A5:6) (40°)	Inlet	51	58	63	68	69	69	71	64	76
HM 63 T6 0,75kW (A2:9) (45°)	Inlet	47	54	59	66	69	70	71	66	76
HM 63 T6 0,75kW (A2:9) (43°)	Inlet	47	54	59	66	69	70	71	66	76
HM 63 T6 0,75kW (A2:9) (40°)	Inlet	48	54	60	66	69	70	71	66	76
HM 71 M6 0,55kW (A2:6) (37°)	Inlet	49	56	61	66	69	71	71	65	76
HM 71 M6 0,55kW (A2:6) (35°)	Inlet	47	54	59	66	68	70	71	64	75
HM 71 M6 0,55kW (A2:6) (33°)	Inlet	48	55	60	67	69	71	71	66	76
HM 71 M6 0,55kW (A2:6) (30°)	Inlet	48	55	61	68	70	72	72	67	77
HM 71 M6 0,55kW (A2:6) (28°)	Inlet	48	54	61	68	70	72	73	68	78
HM 71 M6 0,55kW (A2:6) (25°)	Inlet	47	53	62	69	72	72	74	68	78
HM 71 M6 0,55kW (A2:6) (20°)	Inlet	45	51	62	70	73	72	75	68	79
HM 71 M6 0,55kW (A2:9) (20°)	Inlet	51	57	66	73	76	75	77	70	82
HM 71 M6 0,55kW (A2:9) (25°)	Inlet	51	57	64	72	74	74	76	69	81
HM 71 M6 0,55kW (A2:9) (28°)	Inlet	51	57	63	70	73	73	75	69	80

**Sound power Lw dB (A)**

Model		63 Hz	125 Hz	250 Hz	500 Hz	1000 Hz	2000 Hz	4000 Hz	8000 Hz	Total
HM 71 M6 0,55kW (A2:9) (30°)	Inlet	51	57	63	70	72	73	74	69	79
HM 71 T6 0,55kW (A2:6) (37°)	Inlet	49	56	61	66	69	71	71	65	76
HM 71 T6 0,55kW (A2:6) (35°)	Inlet	47	54	59	66	68	70	71	64	75
HM 71 T6 0,55kW (A2:6) (33°)	Inlet	48	55	60	67	69	71	71	66	76
HM 71 T6 0,55kW (A2:6) (30°)	Inlet	48	55	61	68	70	72	72	67	77
HM 71 T6 0,55kW (A2:6) (28°)	Inlet	48	54	61	68	70	72	73	68	78
HM 71 T6 0,55kW (A2:6) (25°)	Inlet	47	53	62	69	72	72	74	68	78
HM 71 T6 0,55kW (A2:6) (20°)	Inlet	45	51	62	70	73	72	75	68	79
HM 71 T6 0,55kW (A2:9) (20°)	Inlet	51	57	66	73	76	75	77	70	82
HM 71 T6 0,55kW (A2:9) (25°)	Inlet	51	57	64	72	74	74	76	69	81
HM 71 T6 0,55kW (A2:9) (28°)	Inlet	51	57	63	70	73	73	75	69	80
HM 71 T6 0,55kW (A2:9) (30°)	Inlet	51	57	63	70	72	73	74	69	79
HM 71 T6 0,75kW (A2:6) (45°)	Inlet	52	56	64	68	71	71	71	65	77
HM 71 T6 0,75kW (A2:6) (43°)	Inlet	51	57	63	67	70	71	71	65	77
HM 71 T6 0,75kW (A2:6) (40°)	Inlet	50	57	62	67	70	71	71	65	77
HM 71 T6 0,75kW (A2:9) (37°)	Inlet	51	58	63	69	73	74	74	68	79
HM 71 T6 0,75kW (A2:9) (35°)	Inlet	50	57	62	70	73	74	74	68	79
HM 71 T6 0,75kW (A2:9) (33°)	Inlet	50	57	62	70	73	74	74	69	79
HM 71 T6 0,75kW (A5:6) (40°)	Inlet	59	65	71	73	76	77	78	68	83
HM 71 T6 0,75kW (A5:6) (37°)	Inlet	56	63	68	70	73	75	76	65	81
HM 71 T6 0,75kW (A5:6) (35°)	Inlet	54	61	66	67	71	73	74	63	79
HM 71 T6 1,1kW (A2:9) (45°)	Inlet	51	58	63	69	72	73	73	67	78
HM 71 T6 1,1kW (A2:9) (43°)	Inlet	52	59	64	69	73	74	74	68	79
HM 71 T6 1,1kW (A2:9) (40°)	Inlet	52	59	64	69	73	74	74	68	79
HM 80 T6 0,75kW (A2:6) (35°)	Inlet	52	59	64	69	72	74	74	67	79
HM 80 T6 0,75kW (A2:6) (33°)	Inlet	51	58	63	69	72	74	75	68	79
HM 80 T6 0,75kW (A2:6) (30°)	Inlet	50	57	62	69	72	74	75	68	80
HM 80 T6 0,75kW (A2:6) (28°)	Inlet	50	57	62	69	73	74	75	69	80
HM 80 T6 0,75kW (A2:6) (25°)	Inlet	48	55	62	70	73	74	75	69	80
HM 80 T6 0,75kW (A2:6) (20°)	Inlet	45	52	62	70	74	73	75	70	80
HM 80 T6 0,75kW (A2:9) (30°)	Inlet	54	61	66	74	77	78	79	73	84
HM 80 T6 0,75kW (A2:9) (28°)	Inlet	54	61	66	75	78	78	79	73	84
HM 80 T6 0,75kW (A2:9) (25°)	Inlet	52	62	67	77	79	79	80	73	86
HM 80 T6 0,75kW (A2:9) (20°)	Inlet	50	62	68	80	82	80	82	74	87
HM 80 T6 0,75kW (A5:6) (30°)	Inlet	55	62	67	74	78	77	81	74	85
HM 80 T6 1,1kW (A2:6) (43°)	Inlet	52	60	65	69	72	73	73	66	78
HM 80 T6 1,1kW (A2:6) (40°)	Inlet	52	60	65	69	72	73	72	66	78
HM 80 T6 1,1kW (A2:6) (37°)	Inlet	53	60	65	69	72	73	73	67	79
HM 80 T6 1,1kW (A2:9) (35°)	Inlet	53	60	65	72	76	77	77	71	82

**Sound power Lw dB (A)**

Model		63 Hz	125 Hz	250 Hz	500 Hz	1000 Hz	2000 Hz	4000 Hz	8000 Hz	Total
HM 80 T6 1,1kW (A2:9) (33°)	Inlet	54	61	66	73	77	78	78	72	83
HM 80 T6 1,1kW (A5:6) (33°)	Inlet	54	61	66	72	76	75	79	71	83
HM 80 T6 1,1kW (A5:6) (35°)	Inlet	53	60	65	70	73	74	77	67	81
HM 80 T6 1,5kW (A2:6) (45°)	Inlet	53	60	66	70	73	73	73	66	79
HM 80 T6 1,5kW (A2:9) (43°)	Inlet	55	62	67	71	75	76	76	69	81
HM 80 T6 1,5kW (A2:9) (40°)	Inlet	55	62	67	71	75	77	76	70	82
HM 80 T6 1,5kW (A2:9) (37°)	Inlet	54	61	66	72	75	77	76	70	82
HM 80 T6 1,5kW (A5:6) (37°)	Inlet	55	62	67	71	74	75	77	68	81
HM 80 T6 1,5kW (A5:6) (40°)	Inlet	57	64	69	73	75	76	77	68	82
HM 80 T6 2,2kW (A2:9) (45°)	Inlet	54	62	68	71	74	75	75	69	81
HM 80 T6 2,2kW (A5:6) (43°)	Inlet	58	65	70	74	76	76	77	68	82
HM 90 T6 1,5kW (A6:3) (32°)	Inlet	56	62	69	76	77	78	79	73	84
HM 90 T6 1,5kW (A6:3) (30°)	Inlet	56	61	68	75	76	77	79	73	83
HM 90 T6 1,5kW (A6:3) (28°)	Inlet	55	60	67	73	75	76	78	72	82
HM 90 T6 1,5kW (A6:3) (26°)	Inlet	54	59	66	71	74	75	77	71	81
HM 90 T6 1,5kW (A6:3) (24°)	Inlet	53	57	65	69	73	74	76	70	80
HM 90 T6 1,5kW (A6:3) (22°)	Inlet	52	56	64	67	71	72	75	69	79
HM 90 T6 1,5kW (A6:3) (20°)	Inlet	50	54	62	65	70	71	74	68	78
HM 90 T6 1,5kW (A6:6) (24°)	Inlet	57	67	73	80	83	82	83	78	88
HM 90 T6 1,5kW (A6:6) (22°)	Inlet	56	66	72	79	83	81	82	77	88
HM 90 T6 1,5kW (A6:6) (20°)	Inlet	55	65	71	79	83	81	81	77	88
HM 90 T6 2,2kW (A6:3) (38°)	Inlet	57	64	71	79	79	80	81	75	87
HM 90 T6 2,2kW (A6:3) (36°)	Inlet	56	63	70	78	78	79	80	74	85
HM 90 T6 2,2kW (A6:3) (34°)	Inlet	56	62	69	77	77	78	79	74	85
HM 90 T6 2,2kW (A6:6) (30°)	Inlet	59	68	74	81	82	82	84	79	89
HM 90 T6 2,2kW (A6:6) (28°)	Inlet	59	68	73	81	83	82	84	79	89
HM 90 T6 2,2kW (A6:6) (26°)	Inlet	58	67	73	80	83	82	83	78	89
HM 90 T6 3kW (A6:3) (40°)	Inlet	57	65	72	80	80	82	82	76	87
HM 90 T6 3kW (A6:6) (36°)	Inlet	57	65	70	77	78	79	81	75	86
HM 90 T6 3kW (A6:6) (34°)	Inlet	57	66	71	77	79	80	81	76	86
HM 90 T6 3kW (A6:6) (32°)	Inlet	58	67	72	79	80	81	83	77	88
HM 90 T6 4kW (A6:6) (40°)	Inlet	58	67	72	78	79	80	82	76	87
HM 90 T6 4kW (A6:6) (38°)	Inlet	57	66	71	78	79	80	81	76	86
HM 100 T6 1,5kW (A6:3) (26°)	Inlet	56	63	68	74	77	79	81	75	85
HM 100 T6 1,5kW (A6:3) (24°)	Inlet	56	63	68	74	78	79	82	75	86
HM 100 T6 1,5kW (A6:3) (22°)	Inlet	56	63	68	73	78	79	83	75	86
HM 100 T6 1,5kW (A6:3) (20°)	Inlet	55	62	67	72	77	79	82	75	85
HM 100 T6 2,2kW (A6:3) (26°)	Inlet	56	63	68	74	77	79	81	75	85
HM 100 T6 2,2kW (A6:3) (24°)	Inlet	56	63	68	74	78	79	82	75	86

**Sound power Lw dB (A)**

Model		63 Hz	125 Hz	250 Hz	500 Hz	1000 Hz	2000 Hz	4000 Hz	8000 Hz	Total
HM 100 T6 2,2kW (A6:3) (22°)	Inlet	56	63	68	73	78	79	83	75	86
HM 100 T6 2,2kW (A6:3) (20°)	Inlet	55	62	67	72	77	79	82	75	85
HM 100 T6 2,2kW (A6:3) (32°)	Inlet	58	64	70	76	78	79	80	75	85
HM 100 T6 2,2kW (A6:3) (30°)	Inlet	56	63	68	74	77	78	80	74	84
HM 100 T6 2,2kW (A6:3) (28°)	Inlet	56	63	68	74	77	78	80	74	84
HM 100 T6 2,2kW (A6:6) (24°)	Inlet	60	70	76	85	86	85	86	81	92
HM 100 T6 2,2kW (A6:6) (22°)	Inlet	60	70	75	85	86	85	86	81	92
HM 100 T6 2,2kW (A6:6) (20°)	Inlet	59	70	75	86	87	86	86	82	93
HM 100 T6 3kW (A6:3) (36°)	Inlet	60	66	73	79	80	81	81	76	87
HM 100 T6 3kW (A6:3) (34°)	Inlet	60	65	72	78	79	80	81	76	86
HM 100 T6 3kW (A6:6) (28°)	Inlet	63	72	78	85	86	86	87	82	93
HM 100 T6 3kW (A6:6) (26°)	Inlet	62	71	77	85	86	86	86	82	92
HM 100 T6 4kW (A6:3) (40°)	Inlet	60	67	73	80	82	82	82	78	88
HM 100 T6 4kW (A6:3) (38°)	Inlet	60	67	73	79	81	82	82	77	88
HM 100 T6 4kW (A6:6) (32°)	Inlet	63	71	77	83	84	85	86	81	91
HM 100 T6 4kW (A6:6) (30°)	Inlet	64	72	78	85	86	86	87	82	93
HM 100 T6 5,5kW (A6:6) (38°)	Inlet	63	71	76	81	83	84	85	79	90
HM 100 T6 5,5kW (A6:6) (36°)	Inlet	62	70	76	80	82	83	84	79	89
HM 100 T6 5,5kW (A6:6) (34°)	Inlet	62	70	76	81	83	83	85	80	90
HM 100 T6 7,5kW (A6:6) (40°)	Inlet	63	71	77	82	84	85	85	80	91
HM 112 T6 2,2kW (A6:3) (26°)	Inlet	61	68	73	79	83	84	86	81	90
HM 112 T6 2,2kW (A6:3) (24°)	Inlet	60	67	72	79	83	84	86	81	90
HM 112 T6 2,2kW (A6:3) (22°)	Inlet	59	66	71	78	82	83	85	80	90
HM 112 T6 2,2kW (A6:3) (20°)	Inlet	58	65	70	77	82	83	85	80	89
HM 112 T6 2,2kW (A6:6) (20°)	Inlet	60	71	76	88	89	87	89	84	95
HM 112 T6 3kW (A6:3) (32°)	Inlet	63	68	75	80	82	83	85	80	90
HM 112 T6 3kW (A6:3) (30°)	Inlet	62	67	74	80	82	83	85	80	90
HM 112 T6 3kW (A6:3) (28°)	Inlet	62	68	74	80	83	83	86	81	90
HM 112 T6 3kW (A6:6) (24°)	Inlet	61	71	76	86	87	87	88	82	94
HM 112 T6 3kW (A6:6) (22°)	Inlet	61	71	77	87	88	87	88	83	94
HM 112 T6 4kW (A6:3) (36°)	Inlet	63	68	75	81	83	83	85	80	90
HM 112 T6 4kW (A6:3) (34°)	Inlet	63	68	75	80	83	83	85	80	90
HM 112 T6 4kW (A6:6) (28°)	Inlet	64	72	77	86	87	88	89	82	94
HM 112 T6 4kW (A6:6) (26°)	Inlet	63	72	77	86	87	87	88	82	94
HM 112 T6 5,5kW (A6:3) (40°)	Inlet	63	69	75	82	84	84	85	80	91
HM 112 T6 5,5kW (A6:3) (38°)	Inlet	64	69	76	81	83	84	85	81	90
HM 112 T6 5,5kW (A6:6) (32°)	Inlet	65	72	77	83	85	87	88	81	92
HM 112 T6 5,5kW (A6:6) (30°)	Inlet	65	72	77	85	87	88	88	82	93
HM 112 T6 7,5kW (A6:6) (38°)	Inlet	67	74	79	83	86	87	88	81	93



Sound power Lw dB (A)										
Model		63 Hz	125 Hz	250 Hz	500 Hz	1000 Hz	2000 Hz	4000 Hz	8000 Hz	Total
HM 112 T6 7,5kW (A6:6) (36°)	Inlet	65	72	77	81	85	86	87	80	92
HM 112 T6 7,5kW (A6:6) (34°)	Inlet	65	72	77	81	84	86	87	80	92
HM 112 T6 11kW (A6:6) (40°)	Inlet	69	75	81	85	88	89	89	83	94
HM 125 T6 3kW (A7:4) (22°)	Inlet	65	77	82	89	92	93	95	91	99
HM 125 T6 3kW (A7:4) (20°)	Inlet	62	76	81	88	92	92	94	91	99
HM 125 T6 4kW (A7:4) (26°)	Inlet	66	74	79	85	88	90	91	86	96
HM 125 T6 4kW (A7:4) (24°)	Inlet	66	75	80	87	90	91	93	89	97
HM 125 T6 5,5kW (A7:4) (30°)	Inlet	64	71	76	81	85	86	87	81	92
HM 125 T6 5,5kW (A7:4) (28°)	Inlet	66	73	78	83	87	88	89	84	94
HM 125 T6 5,5kW (A7:8) (22°)	Inlet	68	76	82	90	96	99	99	93	104
HM 125 T6 5,5kW (A7:8) (20°)	Inlet	68	76	82	91	98	101	99	94	105
HM 125 T6 7,5kW (A7:4) (36°)	Inlet	64	71	76	81	84	86	86	79	91
HM 125 T6 7,5kW (A7:4) (34°)	Inlet	64	71	76	80	84	85	86	79	91
HM 125 T6 7,5kW (A7:4) (32°)	Inlet	64	71	76	81	84	86	87	80	91
HM 125 T6 7,5kW (A7:8) (26°)	Inlet	68	74	81	88	94	96	96	90	101
HM 125 T6 7,5kW (A7:8) (24°)	Inlet	68	75	81	89	95	97	97	91	103
HM 125 T6 11kW (A7:4) (40°)	Inlet	66	73	78	82	85	87	87	80	92
HM 125 T6 11kW (A7:4) (38°)	Inlet	65	72	77	82	85	87	87	80	92
HM 125 T6 11kW (A7:8) (34°)	Inlet	68	74	80	85	88	90	90	83	95
HM 125 T6 11kW (A7:8) (32°)	Inlet	68	73	80	85	89	92	92	85	97
HM 125 T6 11kW (A7:8) (30°)	Inlet	67	73	80	85	91	93	93	87	98
HM 125 T6 11kW (A7:8) (28°)	Inlet	68	74	80	87	92	95	95	89	100
HM 125 T6 15kW (A7:8) (40°)	Inlet	68	75	80	84	87	89	88	82	94
HM 125 T6 15kW (A7:8) (38°)	Inlet	68	75	80	85	88	90	89	82	95
HM 125 T6 15kW (A7:8) (36°)	Inlet	68	75	80	85	88	90	89	82	95

## Sound / 2/4 poles

Sound power Lw dB (A)										
Model		63 Hz	125 Hz	250 Hz	500 Hz	1000 Hz	2000 Hz	4000 Hz	8000 Hz	Total
HM 45 T2/T4 0,75/0,18kW (A9:4) (3000 RPM - 25°)	Inlet	62	71	76	82	85	86	88	83	93
HM 45 T2/T4 1,1/0,25kW (A9:4) (3000 RPM - 30°)	Inlet	60	67	72	76	80	82	83	76	87
HM 45 T2/T4 1,1/0,25kW (A9:8) (3000 RPM - 25°)	Inlet	65	71	78	85	91	94	94	88	98
HM 45 T2/T4 1,5/0,37kW (A9:4) (3000 RPM - 35°)	Inlet	60	67	72	76	79	81	82	74	87
HM 45 T2/T4 1,5/0,37kW (A9:8) (3000 RPM - 30°)	Inlet	62	67	74	79	85	87	88	81	92





		Sound power Lw dB (A)								
Model		63 Hz	125 Hz	250 Hz	500 Hz	1000 Hz	2000 Hz	4000 Hz	8000 Hz	Total
HM 45 T2/T4 2,2/0,55kW (A9:4) (3000 RPM - 45°)	Inlet	63	70	75	80	83	84	84	78	90
HM 45 T2/T4 2,2/0,55kW (A9:4) (3000 RPM - 40°)	Inlet	61	68	73	77	79	82	82	75	87
HM 45 T2/T4 2,2/0,55kW (A9:8) (3000 RPM - 35°)	Inlet	63	69	75	80	83	85	85	77	90
HM 45 T2/T4 3/0,75kW (A9:4) (3000 RPM - 50°)	Inlet	63	70	75	82	86	86	86	80	92
HM 45 T2/T4 3/0,75kW (A9:8) (3000 RPM - 40°)	Inlet	62	69	74	78	81	83	82	75	88
HM 50 T2/T4 1,1/0,25kW (A9:4) (3000 RPM - 25°)	Inlet	66	73	80	88	93	92	92	87	98
HM 50 T2/T4 1,5/0,37kW (A9:8) (3000 RPM - 25°)	Inlet	64	73	79	87	92	92	92	85	98
HM 50 T2/T4 1,5/0,37kW (A9:4) (3000 RPM - 30°)	Inlet	64	71	76	82	87	86	87	80	92
HM 50 T2/T4 2,2/0,55kW (A9:4) (3000 RPM - 40°)	Inlet	64	71	76	80	83	84	84	77	89
HM 50 T2/T4 2,2/0,55kW (A9:4) (3000 RPM - 35°)	Inlet	64	71	76	80	83	84	85	77	90
HM 50 T2/T4 2,2/0,55kW (A9:8) (3000 RPM - 30°)	Inlet	64	71	76	82	87	88	89	80	93
HM 50 T2/T4 3/0,75kW (A9:4) (3000 RPM - 45°)	Inlet	66	73	78	81	84	85	85	79	91
HM 50 T2/T4 3/0,75kW (A9:8) (3000 RPM - 35°)	Inlet	65	72	77	82	85	88	86	79	92
HM 50 T2/T4 4,5/0,9kW (A9:4) (3000 RPM - 50°)	Inlet	67	74	79	84	87	88	87	82	94
HM 50 T2/T4 4,5/0,9kW (A9:8) (3000 RPM - 40°)	Inlet	65	72	77	81	84	86	85	78	91
HM 56 T2/T4 1,5/0,37kW (A9:4) (3000 RPM - 25°)	Inlet	67	73	80	88	93	92	92	87	98
HM 56 T2/T4 2,2/0,55kW (A9:4) (3000 RPM - 30°)	Inlet	65	72	77	83	88	87	88	81	93
HM 56 T2/T4 2,2/0,55kW (A9:8) (3000 RPM - 25°)	Inlet	65	74	80	87	93	93	93	86	99
HM 56 T2/T4 3/0,75kW (A9:4) (3000 RPM - 40°)	Inlet	65	72	77	81	84	85	85	78	91
HM 56 T2/T4 3/0,75kW (A9:4) (3000 RPM - 35°)	Inlet	65	72	77	82	85	85	87	79	91
HM 56 T2/T4 3/0,75kW (A9:8) (3000 RPM - 30°)	Inlet	65	72	77	83	88	89	89	81	94
HM 56 T2/T4 4,5/0,9kW (A9:4) (3000 RPM - 45°)	Inlet	68	75	80	83	86	87	86	80	92
HM 56 T2/T4 4,5/0,9kW (A9:8) (3000 RPM - 35°)	Inlet	67	74	79	84	87	89	88	81	94

Sound power Lw dB (A)										
Model		63 Hz	125 Hz	250 Hz	500 Hz	1000 Hz	2000 Hz	4000 Hz	8000 Hz	Total
HM 56 T2/T4 5,5/1,5kW (A9:5) (2940 RPM - 45°)	Inlet	92	91	90	89	88	87	88	84	98
HM 56 T2/T4 5,5/1,5kW (A9:5) (2940 RPM - 40°)	Inlet	90	89	87	88	86	86	87	83	97
HM 56 T2/T4 5,5/1,5kW (A9:10) (2940 RPM - 35°)	Inlet	92	89	87	88	90	90	87	83	98
HM 56 T2/T4 8/1,85kW (A9:10) (2940 RPM - 40°)	Inlet	93	90	88	86	87	88	86	81	97
HM 63 T2/T4 1,5/0,37kW (A9:4) (3000 RPM - 25°)	Inlet	66	72	79	87	92	91	91	86	97
HM 63 T2/T4 2,2/0,55kW (A9:4) (3000 RPM - 30°)	Inlet	65	72	77	83	87	87	87	81	93
HM 63 T2/T4 3/0,75kW (A9:4) (3000 RPM - 35°)	Inlet	66	73	78	82	85	86	87	79	92
HM 63 T2/T4 3/0,75kW (A9:8) (3000 RPM - 25°)	Inlet	65	73	80	87	92	93	93	86	98
HM 63 T2/T4 4,5/0,9kW (A9:4) (3000 RPM - 40°)	Inlet	66	73	78	82	85	86	86	79	92
HM 63 T2/T4 4,5/0,9kW (A9:8) (3000 RPM - 30°)	Inlet	65	72	77	83	88	89	90	82	95
HM 63 T2/T4 5,5/1,5kW (A9:10) (2940 RPM - 30°)	Inlet	94	91	89	90	90	92	91	84	100
HM 63 T2/T4 8/1,85kW (A9:5) (2940 RPM - 40°)	Inlet	93	91	90	89	88	88	89	85	99
HM 63 T2/T4 8/1,85kW (A9:10) (2940 RPM - 35°)	Inlet	92	89	87	88	89	89	86	82	98
HM 63 T2/T4 11/2,8kW (A9:5) (2940 RPM - 45°)	Inlet	94	92	91	90	89	88	89	85	99
HM 63 T2/T4 11/2,8kW (A9:5) (2940 RPM - 50°)	Inlet	95	94	92	91	91	91	90	88	102
HM 63 T2/T4 11/3kW (A9:10) (2940 RPM - 40°)	Inlet	95	92	90	88	90	90	88	83	100
HM 63 T2/T4 15/4kW (A9:10) (2940 RPM - 45°)	Inlet	99	96	94	90	91	91	88	84	103

## Sound / 4/6 poles

Sound power Lw dB (A)										
Model		63 Hz	125 Hz	250 Hz	500 Hz	1000 Hz	2000 Hz	4000 Hz	8000 Hz	Total
HM 45 T4/T6 0,55/0,18kW (A0:6) (1410 RPM - 45°)	Inlet	50	57	63	67	69	70	70	64	76
HM 50 T4/T6 0,55/0,18kW (A0:6) (1410 RPM - 45°)	Inlet	51	59	64	68	71	72	72	65	78
HM 56 T4/T6 0,37/0,13kW (A5:6) (1380 RPM - 20°)	Inlet	52	60	67	74	80	75	77	69	84



		Sound power Lw dB (A)								
Model		63 Hz	125 Hz	250 Hz	500 Hz	1000 Hz	2000 Hz	4000 Hz	8000 Hz	Total
HM 56 T4/T6 0,55/0,18kW (A2:6) (1410 RPM - 25°)	Inlet	50	57	65	73	75	76	77	72	82
HM 56 T4/T6 0,55/0,18kW (A2:6) (1410 RPM - 20°)	Inlet	46	54	64	73	75	75	76	72	82
HM 56 T4/T6 0,55/0,18kW (A2:9) (1410 RPM - 20°)	Inlet	54	58	67	73	76	76	77	69	82
HM 56 T4/T6 0,55/0,18kW (A5:6) (1410 RPM - 25°)	Inlet	54	62	67	75	79	76	78	70	84
HM 56 T4/T6 0,75/0,25kW (A2:6) (1420 RPM - 33°)	Inlet	53	60	65	71	73	75	75	70	80
HM 56 T4/T6 0,75/0,25kW (A2:6) (1420 RPM - 30°)	Inlet	52	59	65	71	73	74	76	70	80
HM 56 T4/T6 0,75/0,25kW (A2:6) (1420 RPM - 28°)	Inlet	51	58	65	72	74	75	76	70	81
HM 56 T4/T6 0,75/0,25kW (A2:9) (1420 RPM - 25°)	Inlet	53	58	67	73	76	76	77	71	82
HM 56 T4/T6 0,75/0,25kW (A5:6) (1420 RPM - 30°)	Inlet	56	63	68	77	78	78	80	72	85
HM 56 T4/T6 0,75/0,25kW (A5:6) (1420 RPM - 33°)	Inlet	54	61	66	75	75	76	79	70	83
HM 56 T4/T6 1,1/0,37kW (A2:6) (1430 RPM - 43°)	Inlet	55	61	67	72	74	76	76	70	81
HM 56 T4/T6 1,1/0,37kW (A2:6) (1430 RPM - 40°)	Inlet	54	61	66	71	74	75	76	70	81
HM 56 T4/T6 1,1/0,37kW (A2:6) (1430 RPM - 37°)	Inlet	53	60	65	71	73	75	76	70	81
HM 56 T4/T6 1,1/0,37kW (A2:6) (1430 RPM - 35°)	Inlet	52	59	64	71	73	75	75	70	80
HM 56 T4/T6 1,1/0,37kW (A2:9) (1430 RPM - 35°)	Inlet	53	59	68	73	76	77	79	73	83
HM 56 T4/T6 1,1/0,37kW (A2:9) (1430 RPM - 33°)	Inlet	53	59	68	73	76	77	78	73	83
HM 56 T4/T6 1,1/0,37kW (A2:9) (1430 RPM - 30°)	Inlet	54	59	67	73	77	77	78	73	83
HM 56 T4/T6 1,1/0,37kW (A2:9) (1430 RPM - 28°)	Inlet	54	59	67	73	76	77	78	72	83
HM 56 T4/T6 1,1/0,37kW (A5:6) (1430 RPM - 35°)	Inlet	53	60	65	74	73	75	78	69	82
HM 56 T4/T6 1,1/0,37kW (A5:6) (1430 RPM - 37°)	Inlet	54	61	66	75	74	76	78	69	82
HM 56 T4/T6 1,5/0,5kW (A2:6) (1430 RPM - 45°)	Inlet	56	60	68	72	75	77	76	71	82
HM 56 T4/T6 1,5/0,5kW (A2:9) (1430 RPM - 43°)	Inlet	53	60	69	73	76	77	78	72	83
HM 56 T4/T6 1,5/0,5kW (A2:9) (1430 RPM - 40°)	Inlet	53	60	69	73	76	77	78	72	83

Sound power Lw dB (A)										
Model		63 Hz	125 Hz	250 Hz	500 Hz	1000 Hz	2000 Hz	4000 Hz	8000 Hz	Total
HM 56 T4/T6 1,5/0,5kW (A2:9) (1430 RPM - 37°)	Inlet	53	59	68	73	76	77	78	73	83
HM 56 T4/T6 1,5/0,5kW (A5:6) (1430 RPM - 40°)	Inlet	56	63	68	76	75	76	79	70	83
HM 63 T4/T6 0,55/0,18kW (A2:6) (1410 RPM - 20°)	Inlet	49	51	64	74	73	73	75	70	80
HM 63 T4/T6 0,75/0,25kW (A2:6) (1420 RPM - 25°)	Inlet	53	58	67	75	76	77	78	73	83
HM 63 T4/T6 0,75/0,25kW (A2:9) (1420 RPM - 20°)	Inlet	57	60	71	77	78	77	79	74	85
HM 63 T4/T6 0,75/0,25kW (A5:6) (1420 RPM - 25°)	Inlet	57	66	71	80	80	79	80	75	86
HM 63 T4/T6 1,1/0,37kW (A2:6) (1430 RPM - 33°)	Inlet	53	61	66	73	75	77	77	72	82
HM 63 T4/T6 1,1/0,37kW (A2:6) (1430 RPM - 30°)	Inlet	53	60	66	74	75	77	78	73	83
HM 63 T4/T6 1,1/0,37kW (A2:6) (1430 RPM - 28°)	Inlet	53	59	67	74	76	77	78	73	83
HM 63 T4/T6 1,1/0,37kW (A2:9) (1430 RPM - 25°)	Inlet	57	61	70	76	78	78	80	74	85
HM 63 T4/T6 1,1/0,37kW (A5:6) (1430 RPM - 30°)	Inlet	60	68	74	80	80	79	82	77	87
HM 63 T4/T6 1,5/0,5kW (A2:6) (1430 RPM - 40°)	Inlet	55	62	67	73	76	77	77	72	83
HM 63 T4/T6 1,5/0,5kW (A2:6) (1430 RPM - 37°)	Inlet	54	61	66	73	75	77	77	72	82
HM 63 T4/T6 1,5/0,5kW (A2:6) (1430 RPM - 35°)	Inlet	53	60	65	72	74	77	77	72	82
HM 63 T4/T6 1,5/0,5kW (A2:9) (1430 RPM - 33°)	Inlet	57	63	70	77	79	80	81	75	86
HM 63 T4/T6 1,5/0,5kW (A2:9) (1430 RPM - 30°)	Inlet	58	63	70	76	78	80	81	75	86
HM 63 T4/T6 1,5/0,5kW (A2:9) (1430 RPM - 28°)	Inlet	58	62	70	76	78	79	80	75	85
HM 63 T4/T6 1,5/0,5kW (A5:6) (1430 RPM - 33°)	Inlet	59	68	73	77	78	77	80	75	85
HM 63 T4/T6 1,5/0,5kW (A5:6) (1430 RPM - 35°)	Inlet	59	67	72	75	76	76	79	73	83
HM 63 T4/T6 2,2/0,6kW (A2:6) (1430 RPM - 45°)	Inlet	58	62	70	74	78	78	78	72	84
HM 63 T4/T6 2,2/0,6kW (A2:6) (1430 RPM - 43°)	Inlet	56	62	68	74	76	78	78	72	83
HM 63 T4/T6 2,2/0,6kW (A2:9) (1430 RPM - 43°)	Inlet	57	64	69	76	79	80	81	76	86
HM 63 T4/T6 2,2/0,6kW (A2:9) (1430 RPM - 40°)	Inlet	57	63	69	76	79	80	80	76	86

		Sound power Lw dB (A)								
Model		63 Hz	125 Hz	250 Hz	500 Hz	1000 Hz	2000 Hz	4000 Hz	8000 Hz	Total
HM 63 T4/T6 2,2/0,6kW (A2:9) (1430 RPM - 37°)	Inlet	57	63	70	76	79	80	81	76	86
HM 63 T4/T6 2,2/0,6kW (A2:9) (1430 RPM - 35°)	Inlet	57	63	70	77	79	80	81	76	86
HM 63 T4/T6 2,2/0,6kW (A5:6) (1430 RPM - 40°)	Inlet	60	67	72	77	78	78	80	73	85
HM 63 T4/T6 2,2/0,6kW (A5:6) (1430 RPM - 37°)	Inlet	59	67	72	76	77	77	79	73	84
HM 63 T4/T6 3/0,9kW (A2:9) (1440 RPM - 45°)	Inlet	57	64	69	76	78	80	81	75	86
HM 71 T4/T6 0,75/0,25kW (A2:6) (1420 RPM - 20°)	Inlet	55	61	72	79	83	82	84	78	89
HM 71 T4/T6 0,75/0,25kW (A5:6) (1420 RPM - 20°)	Inlet	55	66	71	86	85	82	84	76	91
HM 71 T4/T6 1,1/0,37kW (A2:6) (1430 RPM - 25°)	Inlet	57	63	71	79	81	82	83	77	88
HM 71 T4/T6 1,1/0,37kW (A2:9) (1430 RPM - 20°)	Inlet	60	66	75	83	85	85	87	79	91
HM 71 T4/T6 1,1/0,37kW (A5:6) (1430 RPM - 25°)	Inlet	59	67	72	84	84	82	84	75	90
HM 71 T4/T6 1,5/0,5kW (A2:6) (1430 RPM - 33°)	Inlet	57	64	69	76	78	80	81	75	86
HM 71 T4/T6 1,5/0,5kW (A2:6) (1430 RPM - 30°)	Inlet	58	64	70	78	79	81	82	77	87
HM 71 T4/T6 1,5/0,5kW (A2:6) (1430 RPM - 28°)	Inlet	57	64	70	78	80	81	82	77	87
HM 71 T4/T6 1,5/0,5kW (A2:9) (1430 RPM - 25°)	Inlet	60	67	74	81	83	84	85	79	90
HM 71 T4/T6 1,5/0,5kW (A5:6) (1430 RPM - 30°)	Inlet	61	68	73	82	82	83	84	73	89
HM 71 T4/T6 2,2/0,6kW (A2:6) (1430 RPM - 40°)	Inlet	59	66	71	77	80	81	80	74	86
HM 71 T4/T6 2,2/0,6kW (A2:6) (1430 RPM - 37°)	Inlet	58	65	70	76	78	80	80	74	85
HM 71 T4/T6 2,2/0,6kW (A2:6) (1430 RPM - 35°)	Inlet	57	64	69	75	77	79	80	74	85
HM 71 T4/T6 2,2/0,6kW (A2:9) (1430 RPM - 33°)	Inlet	60	67	72	79	82	83	83	78	89
HM 71 T4/T6 2,2/0,6kW (A2:9) (1430 RPM - 30°)	Inlet	60	67	72	79	82	83	84	78	89
HM 71 T4/T6 2,2/0,6kW (A2:9) (1430 RPM - 28°)	Inlet	60	67	73	80	82	83	84	78	89
HM 71 T4/T6 2,2/0,6kW (A5:6) (1430 RPM - 35°)	Inlet	62	69	74	76	80	82	83	72	87
HM 71 T4/T6 2,2/0,6kW (A5:6) (1430 RPM - 33°)	Inlet	62	69	74	79	81	83	84	73	88

		Sound power Lw dB (A)								
Model		63 Hz	125 Hz	250 Hz	500 Hz	1000 Hz	2000 Hz	4000 Hz	8000 Hz	Total
HM 71 T4/T6 3/0,9kW (A2:6) (1440 RPM - 45°)	Inlet	62	66	74	77	80	81	81	74	86
HM 71 T4/T6 3/0,9kW (A2:6) (1440 RPM - 43°)	Inlet	60	66	72	77	80	81	80	74	86
HM 71 T4/T6 3/0,9kW (A2:9) (1440 RPM - 37°)	Inlet	61	68	73	79	82	83	83	78	89
HM 71 T4/T6 3/0,9kW (A2:9) (1440 RPM - 35°)	Inlet	60	67	72	79	82	83	83	78	89
HM 71 T4/T6 3/0,9kW (A5:6) (1440 RPM - 40°)	Inlet	67	73	79	81	84	85	86	76	91
HM 71 T4/T6 3/0,9kW (A5:6) (1440 RPM - 37°)	Inlet	65	71	77	79	82	84	85	74	89
HM 80 T4/T6 1,1/0,37kW (A2:6) (1430 RPM - 20°)	Inlet	54	61	71	79	83	83	84	79	89
HM 80 T4/T6 1,5/0,5kW (A2:6) (1430 RPM - 25°)	Inlet	57	64	72	79	83	83	84	79	89
HM 80 T4/T6 1,5/0,5kW (A2:9) (1430 RPM - 20°)	Inlet	60	72	77	89	91	89	92	84	97
HM 80 T4/T6 2,2/0,6kW (A2:6) (1430 RPM - 33°)	Inlet	61	68	73	79	82	84	84	77	89
HM 80 T4/T6 2,2/0,6kW (A2:6) (1430 RPM - 30°)	Inlet	60	67	72	79	82	84	84	78	89
HM 80 T4/T6 2,2/0,6kW (A2:6) (1430 RPM - 28°)	Inlet	60	67	72	79	82	84	84	78	89
HM 80 T4/T6 2,2/0,6kW (A2:9) (1430 RPM - 25°)	Inlet	62	71	76	86	89	88	90	83	95
HM 80 T4/T6 3/0,9kW (A2:6) (1440 RPM - 37°)	Inlet	62	69	74	78	81	83	83	76	88
HM 80 T4/T6 3/0,9kW (A2:6) (1440 RPM - 35°)	Inlet	62	69	74	78	81	84	84	77	89
HM 80 T4/T6 3/0,9kW (A2:9) (1440 RPM - 30°)	Inlet	63	70	75	84	87	88	88	82	93
HM 80 T4/T6 3/0,9kW (A2:9) (1440 RPM - 28°)	Inlet	63	71	76	85	88	88	89	82	94
HM 80 T4/T6 3/0,9kW (A5:6) (1440 RPM - 30°)	Inlet	64	71	76	83	87	86	90	83	94
HM 80 T4/T6 3/0,9kW (A5:6) (1440 RPM - 33°)	Inlet	63	70	75	81	85	84	88	80	91
HM 80 T4/T6 3/0,9kW (A5:6) (1440 RPM - 35°)	Inlet	62	69	74	79	82	82	86	76	89
HM 80 T4/T6 4/1,1kW (A2:6) (1430 RPM - 43°)	Inlet	62	69	75	78	81	82	82	75	88
HM 80 T4/T6 4/1,1kW (A2:6) (1430 RPM - 40°)	Inlet	61	69	74	78	81	82	82	75	88
HM 80 T4/T6 4/1,1kW (A2:9) (1430 RPM - 35°)	Inlet	62	69	74	81	85	87	86	80	92

Sound power Lw dB (A)										
Model		63 Hz	125 Hz	250 Hz	500 Hz	1000 Hz	2000 Hz	4000 Hz	8000 Hz	Total
HM 80 T4/T6 4/1,1kW (A2:9) (1430 RPM - 33°)	Inlet	63	70	75	83	86	87	87	81	93
HM 80 T4/T6 4/1,1kW (A5:6) (1430 RPM - 40°)	Inlet	66	73	78	82	84	84	86	76	91
HM 80 T4/T6 4/1,1kW (A5:6) (1430 RPM - 37°)	Inlet	64	71	76	80	83	83	86	76	90
HM 80 T4/T6 5,5/1,85kW (A2:6) (1450 RPM - 45°)	Inlet	62	69	75	79	82	82	82	75	88
HM 80 T4/T6 5,5/1,85kW (A2:9) (1450 RPM - 43°)	Inlet	64	71	76	81	84	86	85	79	91
HM 80 T4/T6 5,5/1,85kW (A2:9) (1450 RPM - 40°)	Inlet	64	71	76	81	84	86	85	79	91
HM 80 T4/T6 5,5/1,85kW (A2:9) (1450 RPM - 37°)	Inlet	63	70	75	81	85	87	86	80	91
HM 90 T4/T6 3/0,9kW (A6:3) (1440 RPM - 22°)	Inlet	61	65	73	77	81	82	85	79	89
HM 90 T4/T6 3/0,9kW (A6:3) (1440 RPM - 20°)	Inlet	60	63	72	75	79	80	84	78	87
HM 90 T4/T6 4/1,1kW (A6:3) (1430 RPM - 28°)	Inlet	64	69	77	82	84	85	87	82	92
HM 90 T4/T6 4/1,1kW (A6:3) (1430 RPM - 26°)	Inlet	63	68	76	81	83	84	87	81	91
HM 90 T4/T6 4/1,1kW (A6:3) (1430 RPM - 24°)	Inlet	62	67	75	79	82	83	86	80	90
HM 90 T4/T6 5,5/1,85kW (A6:3) (1450 RPM - 32°)	Inlet	65	71	78	86	86	87	88	83	94
HM 90 T4/T6 5,5/1,85kW (A6:3) (1450 RPM - 30°)	Inlet	65	71	78	84	85	86	88	82	93
HM 90 T4/T6 5,5/1,85kW (A6:6) (1450 RPM - 22°)	Inlet	66	75	81	89	92	91	91	86	97
HM 90 T4/T6 5,5/1,85kW (A6:6) (1450 RPM - 20°)	Inlet	65	75	81	88	92	90	91	86	97
HM 90 T4/T6 7,5/2,2kW (A6:3) (1450 RPM - 36°)	Inlet	66	72	79	88	87	89	89	84	95
HM 90 T4/T6 7,5/2,2kW (A6:3) (1450 RPM - 34°)	Inlet	66	72	79	87	87	88	89	83	94
HM 90 T4/T6 7,5/2,2kW (A6:6) (1450 RPM - 28°)	Inlet	68	77	83	90	92	92	93	88	98
HM 90 T4/T6 7,5/2,2kW (A6:6) (1450 RPM - 26°)	Inlet	67	77	82	90	92	91	92	88	98
HM 90 T4/T6 7,5/2,2kW (A6:6) (1450 RPM - 24°)	Inlet	67	76	82	89	92	91	92	87	98
HM 90 T4/T6 11/3,6kW (A6:3) (1430 RPM - 38°)	Inlet	66	73	80	89	89	90	90	85	96
HM 90 T4/T6 11/3,6kW (A6:3) (1430 RPM - 40°)	Inlet	66	74	81	89	90	91	91	86	97

Sound power Lw dB (A)										
Model		63 Hz	125 Hz	250 Hz	500 Hz	1000 Hz	2000 Hz	4000 Hz	8000 Hz	Total
HM 90 T4/T6 11/3,6kW (A6:6) (1430 RPM - 34°)	Inlet	66	75	80	87	88	89	91	85	95
HM 90 T4/T6 11/3,6kW (A6:6) (1430 RPM - 32°)	Inlet	68	77	82	89	90	90	92	87	97
HM 90 T4/T6 11/3,6kW (A6:6) (1430 RPM - 30°)	Inlet	69	78	83	90	92	92	93	89	99
HM 90 T4/T6 15/4,4kW (A6:6) (1420 RPM - 40°)	Inlet	68	76	81	88	89	90	91	85	96
HM 90 T4/T6 15/4,4kW (A6:6) (1420 RPM - 38°)	Inlet	67	76	81	87	88	89	91	85	96
HM 90 T4/T6 15/4,4kW (A6:6) (1420 RPM - 36°)	Inlet	66	75	80	86	88	89	90	85	95
HM 100 T4/T6 5,5/1,85kW (A6:3) (1450 RPM - 26°)	Inlet	66	72	78	83	87	88	91	84	94
HM 100 T4/T6 5,5/1,85kW (A6:3) (1450 RPM - 24°)	Inlet	66	72	78	83	87	88	91	85	95
HM 100 T4/T6 5,5/1,85kW (A6:3) (1450 RPM - 22°)	Inlet	64	71	76	81	87	88	92	84	95
HM 100 T4/T6 5,5/1,85kW (A6:3) (1450 RPM - 20°)	Inlet	64	71	76	81	87	88	92	84	95
HM 100 T4/T6 7,5/2,2kW (A6:3) (1450 RPM - 30°)	Inlet	66	72	78	84	86	87	89	83	94
HM 100 T4/T6 7,5/2,2kW (A6:3) (1450 RPM - 28°)	Inlet	66	72	78	83	86	88	90	84	94
HM 100 T4/T6 7,5/2,2kW (A6:6) (1450 RPM - 22°)	Inlet	69	80	85	95	95	95	95	91	102
HM 100 T4/T6 7,5/2,2kW (A6:6) (1450 RPM - 20°)	Inlet	69	80	85	95	96	95	95	91	102
HM 100 T4/T6 11/3,6kW (A6:3) (1430 RPM - 36°)	Inlet	69	75	82	88	90	90	91	86	96
HM 100 T4/T6 11/3,6kW (A6:3) (1430 RPM - 34°)	Inlet	69	75	81	87	89	90	90	85	96
HM 100 T4/T6 11/3,6kW (A6:3) (1430 RPM - 32°)	Inlet	68	73	80	85	87	88	90	84	95
HM 100 T4/T6 11/3,6kW (A6:6) (1430 RPM - 28°)	Inlet	73	81	87	95	95	95	96	92	103
HM 100 T4/T6 11/3,6kW (A6:6) (1430 RPM - 26°)	Inlet	71	81	86	94	95	95	96	91	102
HM 100 T4/T6 11/3,6kW (A6:6) (1430 RPM - 24°)	Inlet	70	80	85	94	95	95	95	91	102
HM 100 T4/T6 15/4,4kW (A6:3) (1420 RPM - 38°)	Inlet	69	76	82	89	90	91	91	86	97
HM 100 T4/T6 15/4,4kW (A6:3) (1420 RPM - 40°)	Inlet	69	77	82	90	91	92	92	87	98
HM 100 T4/T6 15/4,4kW (A6:6) (1420 RPM - 32°)	Inlet	72	80	86	92	94	94	95	90	101



Sound power Lw dB (A)										
Model		63 Hz	125 Hz	250 Hz	500 Hz	1000 Hz	2000 Hz	4000 Hz	8000 Hz	Total
HM 100 T4/T6 15/4,4kW (A6:6) (1420 RPM - 30°)	Inlet	73	81	87	94	95	95	97	92	102
HM 100 T4/T6 18,5/6kW (A6:6) (1420 RPM - 36°)	Inlet	71	79	85	89	92	92	94	88	99
HM 100 T4/T6 18,5/6kW (A6:6) (1420 RPM - 34°)	Inlet	72	80	86	90	92	93	94	89	99
HM 100 T4/T6 22/7,5kW (A6:6) (1420 RPM - 40°)	Inlet	73	81	86	91	93	94	95	89	101
HM 100 T4/T6 22/7,5kW (A6:6) (1420 RPM - 38°)	Inlet	72	80	86	90	92	93	94	89	99
HM 112 T4/T6 5,5/1,85kW (A6:3) (1450 RPM - 22°)	Inlet	69	76	81	87	92	93	95	90	99
HM 112 T4/T6 5,5/1,85kW (A6:3) (1450 RPM - 20°)	Inlet	67	74	79	86	91	92	94	89	99
HM 112 T4/T6 7,5/2,2kW (A6:3) (1450 RPM - 26°)	Inlet	71	77	83	89	92	93	96	90	100
HM 112 T4/T6 7,5/2,2kW (A6:3) (1450 RPM - 24°)	Inlet	70	77	82	88	92	93	95	90	100
HM 112 T4/T6 11/3,6kW (A6:3) (1430 RPM - 30°)	Inlet	71	77	83	89	92	92	95	90	99
HM 112 T4/T6 11/3,6kW (A6:3) (1430 RPM - 28°)	Inlet	71	77	83	89	92	93	95	90	100
HM 112 T4/T6 11/3,6kW (A6:6) (1430 RPM - 22°)	Inlet	70	80	86	96	98	97	98	93	104
HM 112 T4/T6 11/3,6kW (A6:6) (1430 RPM - 20°)	Inlet	69	80	86	97	98	97	98	93	104
HM 112 T4/T6 15/4,4kW (A6:3) (1420 RPM - 36°)	Inlet	73	78	85	90	92	93	94	90	99
HM 112 T4/T6 15/4,4kW (A6:3) (1420 RPM - 34°)	Inlet	73	77	85	90	92	92	94	90	99
HM 112 T4/T6 15/4,4kW (A6:3) (1420 RPM - 32°)	Inlet	72	77	84	89	92	92	94	90	99
HM 112 T4/T6 15/4,4kW (A6:6) (1420 RPM - 28°)	Inlet	74	82	87	95	97	97	98	92	104
HM 112 T4/T6 15/4,4kW (A6:6) (1420 RPM - 26°)	Inlet	72	81	86	95	97	97	98	92	104
HM 112 T4/T6 15/4,4kW (A6:6) (1420 RPM - 24°)	Inlet	71	80	86	95	97	96	97	92	103
HM 112 T4/T6 18,5/6kW (A6:3) (1420 RPM - 38°)	Inlet	73	79	85	91	93	93	94	90	100
HM 112 T4/T6 18,5/6kW (A6:6) (1420 RPM - 30°)	Inlet	75	82	87	94	96	97	98	91	103
HM 112 T4/T6 22/7,5kW (A6:3) (1420 RPM - 40°)	Inlet	73	79	85	91	93	94	94	90	100
HM 112 T4/T6 22/7,5kW (A6:6) (1420 RPM - 34°)	Inlet	74	81	86	91	94	95	96	89	101

Sound power Lw dB (A)										
Model		63 Hz	125 Hz	250 Hz	500 Hz	1000 Hz	2000 Hz	4000 Hz	8000 Hz	Total
HM 112 T4/T6 22/7,5kW (A6:6) (1420 RPM - 32°)	Inlet	74	81	86	92	95	96	97	90	102
HM 125 T4/T6 11/3,6kW (A7:4) (1430 RPM - 22°)	Inlet	75	86	91	98	102	103	105	101	109
HM 125 T4/T6 11/3,6kW (A7:4) (1430 RPM - 20°)	Inlet	72	85	90	98	102	102	104	101	109
HM 125 T4/T6 15/4,4kW (A7:4) (1420 RPM - 26°)	Inlet	76	84	89	94	98	99	101	95	106
HM 125 T4/T6 15/4,4kW (A7:4) (1420 RPM - 24°)	Inlet	75	85	90	96	100	101	103	98	107
HM 125 T4/T6 15/4,4kW (A7:8) (1420 RPM - 20°)	Inlet	77	85	92	101	107	110	109	104	115
HM 125 T4/T6 18,5/6kW (A7:4) (1420 RPM - 30°)	Inlet	74	81	86	90	94	96	97	90	102
HM 125 T4/T6 18,5/6kW (A7:4) (1420 RPM - 28°)	Inlet	75	82	87	92	96	98	99	93	104
HM 125 T4/T6 18,5/6kW (A7:8) (1420 RPM - 22°)	Inlet	77	85	91	99	106	109	108	103	113
HM 125 T4/T6 22/7,5kW (A7:4) (1420 RPM - 32°)	Inlet	74	81	86	90	93	95	96	89	101
HM 125 T4/T6 22/7,5kW (A7:8) (1420 RPM - 24°)	Inlet	77	84	91	98	105	107	107	101	112

## Sound / 4/8 poles

Sound power Lw dB (A)										
Model		63 Hz	125 Hz	250 Hz	500 Hz	1000 Hz	2000 Hz	4000 Hz	8000 Hz	Total
HM 45 T4/T8 0,33/0,04kW (A0:6) (1420 RPM - 40°)	Inlet	39	57	69	74	76	70	63	58	79
HM 50 T4/T8 0,55/0,09kW (A0:6) (1420 RPM - 40°)	Inlet	51	59	64	68	71	72	72	65	78
HM 56 T4/T8 0,33/0,04kW (A5:6) (720 RPM - 20°)	Inlet	37	45	52	59	65	60	62	54	68
HM 56 T4/T8 0,33/0,04kW (A5:6) (1420 RPM - 20°)	Inlet	52	60	67	74	80	75	77	69	84
HM 56 T4/T8 0,55/0,09kW (A2:6) (720 RPM - 25°)	Inlet	34	42	50	57	59	60	61	56	66
HM 56 T4/T8 0,55/0,09kW (A2:6) (720 RPM - 20°)	Inlet	30	38	48	57	59	59	60	56	66
HM 56 T4/T8 0,55/0,09kW (A2:6) (1420 RPM - 25°)	Inlet	50	57	65	73	75	76	77	72	82
HM 56 T4/T8 0,55/0,09kW (A2:6) (1420 RPM - 20°)	Inlet	46	54	64	73	75	75	76	72	82
HM 56 T4/T8 0,55/0,09kW (A2:9) (720 RPM - 20°)	Inlet	38	42	51	58	60	60	61	53	66

**Sound power Lw dB (A)**

Model		63 Hz	125 Hz	250 Hz	500 Hz	1000 Hz	2000 Hz	4000 Hz	8000 Hz	Total
HM 56 T4/T8 0,55/0,09kW (A2:9) (1420 RPM - 20°)	Inlet	54	58	67	73	76	76	77	69	82
HM 56 T4/T8 0,55/0,09kW (A5:6) (720 RPM - 25°)	Inlet	39	47	52	60	64	61	63	55	69
HM 56 T4/T8 0,55/0,09kW (A5:6) (1420 RPM - 25°)	Inlet	54	62	67	75	79	76	78	70	84
HM 56 T4/T8 0,75/0,12kW (A2:6) (720 RPM - 33°)	Inlet	37	44	49	55	57	59	60	54	64
HM 56 T4/T8 0,75/0,12kW (A2:6) (720 RPM - 30°)	Inlet	36	43	49	55	57	58	60	54	64
HM 56 T4/T8 0,75/0,12kW (A2:6) (720 RPM - 28°)	Inlet	35	42	49	56	58	59	60	55	65
HM 56 T4/T8 0,75/0,12kW (A2:6) (1420 RPM - 28°)	Inlet	51	58	65	72	74	75	76	70	81
HM 56 T4/T8 0,75/0,12kW (A2:6) (1420 RPM - 33°)	Inlet	53	60	65	71	73	75	75	70	80
HM 56 T4/T8 0,75/0,12kW (A2:6) (1420 RPM - 30°)	Inlet	52	59	65	71	73	74	76	70	80
HM 56 T4/T8 0,75/0,12kW (A2:9) (720 RPM - 25°)	Inlet	37	42	51	57	60	60	61	55	66
HM 56 T4/T8 0,75/0,12kW (A2:9) (1420 RPM - 25°)	Inlet	53	58	67	73	76	76	77	71	82
HM 56 T4/T8 0,75/0,12kW (A5:6) (720 RPM - 33°)	Inlet	39	46	51	60	60	61	64	55	68
HM 56 T4/T8 0,75/0,12kW (A5:6) (720 RPM - 30°)	Inlet	41	48	53	62	63	62	65	57	69
HM 56 T4/T8 0,75/0,12kW (A5:6) (1420 RPM - 30°)	Inlet	54	61	66	75	75	76	79	70	83
HM 56 T4/T8 0,75/0,12kW (A5:6) (1420 RPM - 33°)	Inlet	56	63	68	77	78	78	80	72	85
HM 56 T4/T8 1,1/0,18kW (A2:6) (720 RPM - 43°)	Inlet	39	45	51	56	58	60	60	54	65
HM 56 T4/T8 1,1/0,18kW (A2:6) (720 RPM - 40°)	Inlet	38	45	50	56	58	60	60	54	65
HM 56 T4/T8 1,1/0,18kW (A2:6) (720 RPM - 37°)	Inlet	37	44	49	55	57	59	60	54	65
HM 56 T4/T8 1,1/0,18kW (A2:6) (720 RPM - 35°)	Inlet	36	43	48	55	57	59	60	54	64
HM 56 T4/T8 1,1/0,18kW (A2:6) (1420 RPM - 43°)	Inlet	55	61	67	72	74	76	76	70	81
HM 56 T4/T8 1,1/0,18kW (A2:6) (1420 RPM - 40°)	Inlet	54	61	66	71	74	75	76	70	81
HM 56 T4/T8 1,1/0,18kW (A2:6) (1420 RPM - 37°)	Inlet	53	60	65	71	73	75	76	70	81
HM 56 T4/T8 1,1/0,18kW (A2:6) (1420 RPM - 35°)	Inlet	52	59	64	71	73	75	75	70	80

Sound power Lw dB (A)										
Model		63 Hz	125 Hz	250 Hz	500 Hz	1000 Hz	2000 Hz	4000 Hz	8000 Hz	Total
HM 56 T4/T8 1,1/0,18kW (A2:9) (720 RPM - 35°)	Inlet	37	43	52	57	60	61	63	57	67
HM 56 T4/T8 1,1/0,18kW (A2:9) (720 RPM - 33°)	Inlet	37	43	52	57	61	61	63	57	67
HM 56 T4/T8 1,1/0,18kW (A2:9) (720 RPM - 30°)	Inlet	38	43	51	57	61	61	62	57	67
HM 56 T4/T8 1,1/0,18kW (A2:9) (720 RPM - 28°)	Inlet	38	43	51	57	61	61	62	56	67
HM 56 T4/T8 1,1/0,18kW (A2:9) (1420 RPM - 28°)	Inlet	54	59	67	73	76	77	78	72	83
HM 56 T4/T8 1,1/0,18kW (A2:9) (1420 RPM - 35°)	Inlet	53	59	68	73	76	77	79	73	83
HM 56 T4/T8 1,1/0,18kW (A2:9) (1420 RPM - 33°)	Inlet	53	59	68	73	76	77	78	73	83
HM 56 T4/T8 1,1/0,18kW (A2:9) (1420 RPM - 30°)	Inlet	54	59	67	73	77	77	78	73	83
HM 56 T4/T8 1,1/0,18kW (A5:6) (720 RPM - 37°)	Inlet	39	46	51	59	59	60	63	54	67
HM 56 T4/T8 1,1/0,18kW (A5:6) (720 RPM - 35°)	Inlet	38	45	50	58	58	60	62	54	66
HM 56 T4/T8 1,1/0,18kW (A5:6) (1420 RPM - 37°)	Inlet	54	61	66	75	74	76	78	69	82
HM 56 T4/T8 1,1/0,18kW (A5:6) (1420 RPM - 35°)	Inlet	53	60	65	74	73	75	78	69	82
HM 56 T4/T8 1,5/0,25kW (A2:6) (720 RPM - 45°)	Inlet	40	44	52	56	59	61	60	55	66
HM 56 T4/T8 1,5/0,25kW (A2:6) (1420 RPM - 45°)	Inlet	56	60	68	72	75	77	76	71	82
HM 56 T4/T8 1,5/0,25kW (A2:9) (720 RPM - 43°)	Inlet	37	44	53	57	60	61	62	56	67
HM 56 T4/T8 1,5/0,25kW (A2:9) (720 RPM - 40°)	Inlet	37	44	53	57	60	61	62	56	67
HM 56 T4/T8 1,5/0,25kW (A2:9) (720 RPM - 37°)	Inlet	37	43	52	57	60	61	62	57	67
HM 56 T4/T8 1,5/0,25kW (A2:9) (1420 RPM - 37°)	Inlet	53	59	68	73	76	77	78	73	83
HM 56 T4/T8 1,5/0,25kW (A2:9) (1420 RPM - 43°)	Inlet	53	60	69	73	76	77	78	72	83
HM 56 T4/T8 1,5/0,25kW (A2:9) (1420 RPM - 40°)	Inlet	53	60	69	73	76	77	78	72	83
HM 56 T4/T8 1,5/0,25kW (A5:6) (720 RPM - 40°)	Inlet	41	48	53	60	60	61	63	55	68
HM 56 T4/T8 1,5/0,25kW (A5:6) (1420 RPM - 40°)	Inlet	56	63	68	76	75	76	79	70	83
HM 63 T4/T8 0,55/0,09kW (A2:6) (720 RPM - 20°)	Inlet	33	36	48	58	58	57	59	54	64

		Sound power Lw dB (A)								
Model		63 Hz	125 Hz	250 Hz	500 Hz	1000 Hz	2000 Hz	4000 Hz	8000 Hz	Total
HM 63 T4/T8 0,55/0,09kW (A2:6) (1420 RPM - 20°)	Inlet	49	51	64	74	73	73	75	70	80
HM 63 T4/T8 0,75/0,12kW (A2:6) (720 RPM - 25°)	Inlet	37	42	51	59	60	61	62	57	67
HM 63 T4/T8 0,75/0,12kW (A2:6) (1420 RPM - 25°)	Inlet	53	58	67	75	76	77	78	73	83
HM 63 T4/T8 0,75/0,12kW (A2:9) (720 RPM - 20°)	Inlet	41	44	55	61	63	62	63	58	69
HM 63 T4/T8 0,75/0,12kW (A2:9) (1420 RPM - 20°)	Inlet	57	60	71	77	78	77	79	74	85
HM 63 T4/T8 0,75/0,12kW (A5:6) (720 RPM - 25°)	Inlet	42	51	56	65	65	64	65	60	71
HM 63 T4/T8 0,75/0,12kW (A5:6) (1420 RPM - 25°)	Inlet	57	66	71	80	80	79	80	75	86
HM 63 T4/T8 1,1/0,18kW (A2:6) (720 RPM - 33°)	Inlet	37	45	50	57	59	61	62	56	67
HM 63 T4/T8 1,1/0,18kW (A2:6) (720 RPM - 30°)	Inlet	37	44	51	58	60	61	62	57	67
HM 63 T4/T8 1,1/0,18kW (A2:6) (720 RPM - 28°)	Inlet	37	43	51	58	60	61	62	57	67
HM 63 T4/T8 1,1/0,18kW (A2:6) (1420 RPM - 28°)	Inlet	53	59	67	74	76	77	78	73	83
HM 63 T4/T8 1,1/0,18kW (A2:6) (1420 RPM - 33°)	Inlet	53	61	66	73	75	77	77	72	82
HM 63 T4/T8 1,1/0,18kW (A2:6) (1420 RPM - 30°)	Inlet	53	60	66	74	75	77	78	73	83
HM 63 T4/T8 1,1/0,18kW (A2:9) (720 RPM - 28°)	Inlet	42	46	54	60	62	63	65	59	69
HM 63 T4/T8 1,1/0,18kW (A2:9) (720 RPM - 25°)	Inlet	41	45	54	60	62	62	64	58	69
HM 63 T4/T8 1,1/0,18kW (A2:9) (1420 RPM - 28°)	Inlet	58	62	70	76	78	79	80	75	85
HM 63 T4/T8 1,1/0,18kW (A2:9) (1420 RPM - 25°)	Inlet	57	61	70	76	78	78	80	74	85
HM 63 T4/T8 1,1/0,18kW (A5:6) (720 RPM - 30°)	Inlet	45	53	59	65	65	64	67	62	72
HM 63 T4/T8 1,1/0,18kW (A5:6) (1420 RPM - 30°)	Inlet	60	68	74	80	80	79	82	77	87
HM 63 T4/T8 1,5/0,25kW (A2:6) (720 RPM - 40°)	Inlet	40	46	52	58	60	62	62	56	67
HM 63 T4/T8 1,5/0,25kW (A2:6) (720 RPM - 37°)	Inlet	38	45	50	57	59	61	61	56	67
HM 63 T4/T8 1,5/0,25kW (A2:6) (720 RPM - 35°)	Inlet	37	44	49	56	58	61	61	56	66
HM 63 T4/T8 1,5/0,25kW (A2:6) (1420 RPM - 35°)	Inlet	53	60	65	72	74	77	77	72	82

		Sound power Lw dB (A)								
Model		63 Hz	125 Hz	250 Hz	500 Hz	1000 Hz	2000 Hz	4000 Hz	8000 Hz	Total
HM 63 T4/T8 1,5/0,25kW (A2:6) (1420 RPM - 40°)	Inlet	55	62	67	73	76	77	77	72	83
HM 63 T4/T8 1,5/0,25kW (A2:6) (1420 RPM - 37°)	Inlet	54	61	66	73	75	77	77	72	82
HM 63 T4/T8 1,5/0,25kW (A2:9) (720 RPM - 33°)	Inlet	41	47	54	61	63	64	65	60	70
HM 63 T4/T8 1,5/0,25kW (A2:9) (720 RPM - 30°)	Inlet	42	47	54	61	62	64	65	60	70
HM 63 T4/T8 1,5/0,25kW (A2:9) (1420 RPM - 33°)	Inlet	57	63	70	77	79	80	81	75	86
HM 63 T4/T8 1,5/0,25kW (A2:9) (1420 RPM - 30°)	Inlet	58	63	70	76	78	80	81	75	86
HM 63 T4/T8 1,5/0,25kW (A5:6) (720 RPM - 35°)	Inlet	59	67	72	75	76	76	79	73	83
HM 63 T4/T8 1,5/0,25kW (A5:6) (720 RPM - 33°)	Inlet	44	52	58	62	63	62	65	60	70
HM 63 T4/T8 1,5/0,25kW (A5:6) (1420 RPM - 35°)	Inlet	59	67	72	75	76	76	79	73	83
HM 63 T4/T8 1,5/0,25kW (A5:6) (1420 RPM - 33°)	Inlet	59	68	73	77	78	77	80	75	85
HM 63 T4/T8 2,2/0,37kW (A2:6) (720 RPM - 45°)	Inlet	42	46	54	59	62	62	62	56	68
HM 63 T4/T8 2,2/0,37kW (A2:6) (720 RPM - 43°)	Inlet	40	46	52	58	60	62	62	56	67
HM 63 T4/T8 2,2/0,37kW (A2:6) (1420 RPM - 43°)	Inlet	56	62	68	74	76	78	78	72	83
HM 63 T4/T8 2,2/0,37kW (A2:6) (1420 RPM - 45°)	Inlet	58	62	70	74	78	78	78	72	84
HM 63 T4/T8 2,2/0,37kW (A2:9) (720 RPM - 43°)	Inlet	41	48	53	60	63	64	65	60	70
HM 63 T4/T8 2,2/0,37kW (A2:9) (720 RPM - 40°)	Inlet	41	48	53	60	63	64	65	60	70
HM 63 T4/T8 2,2/0,37kW (A2:9) (720 RPM - 37°)	Inlet	41	47	54	60	63	64	65	60	70
HM 63 T4/T8 2,2/0,37kW (A2:9) (720 RPM - 35°)	Inlet	41	47	54	61	63	64	65	60	70
HM 63 T4/T8 2,2/0,37kW (A2:9) (1420 RPM - 43°)	Inlet	57	64	69	76	79	80	81	76	86
HM 63 T4/T8 2,2/0,37kW (A2:9) (1420 RPM - 40°)	Inlet	57	63	69	76	79	80	80	76	86
HM 63 T4/T8 2,2/0,37kW (A2:9) (1420 RPM - 37°)	Inlet	57	63	70	76	79	80	81	76	86
HM 63 T4/T8 2,2/0,37kW (A2:9) (1420 RPM - 35°)	Inlet	57	63	70	77	79	80	81	76	86
HM 63 T4/T8 2,2/0,37kW (A5:6) (720 RPM - 37°)	Inlet	44	52	57	61	62	62	64	58	69

**Sound power Lw dB (A)**

Model		63 Hz	125 Hz	250 Hz	500 Hz	1000 Hz	2000 Hz	4000 Hz	8000 Hz	Total
HM 63 T4/T8 2,2/0,37kW (A5:6) (720 RPM - 40°)	Inlet	45	52	57	62	62	63	65	58	70
HM 63 T4/T8 2,2/0,37kW (A5:6) (1420 RPM - 37°)	Inlet	59	67	72	76	77	77	79	73	84
HM 63 T4/T8 2,2/0,37kW (A5:6) (1420 RPM - 40°)	Inlet	60	67	72	77	78	78	80	73	85
HM 63 T4/T8 3/0,55kW (A2:9) (720 RPM - 45°)	Inlet	41	48	53	60	63	64	65	59	70
HM 63 T4/T8 3/0,55kW (A2:9) (1420 RPM - 45°)	Inlet	57	64	69	76	78	80	81	75	86
HM 71 T4/T8 0,75/0,12kW (A2:6) (1420 RPM - 20°)	Inlet	55	61	72	79	83	82	84	78	89
HM 71 T4/T8 0,75/0,12kW (A5:6) (720 RPM - 20°)	Inlet	40	51	56	71	70	67	69	61	76
HM 71 T4/T8 0,75/0,12kW (A5:6) (1420 RPM - 20°)	Inlet	55	66	71	86	85	82	84	76	91
HM 71 T4/T8 1,1/0,18kW (A2:6) (1420 RPM - 25°)	Inlet	57	63	71	79	81	82	83	77	88
HM 71 T4/T8 1,1/0,18kW (A2:9) (720 RPM - 20°)	Inlet	44	51	60	67	69	69	71	64	76
HM 71 T4/T8 1,1/0,18kW (A2:9) (1420 RPM - 20°)	Inlet	60	66	75	83	85	85	87	79	91
HM 71 T4/T8 1,1/0,18kW (A5:6) (720 RPM - 25°)	Inlet	44	51	56	69	68	67	69	60	75
HM 71 T4/T8 1,1/0,18kW (A5:6) (1420 RPM - 25°)	Inlet	59	67	72	84	84	82	84	75	90
HM 71 T4/T8 1,5/0,25kW (A2:6) (720 RPM - 28°)	Inlet	42	48	54	62	64	65	66	61	71
HM 71 T4/T8 1,5/0,25kW (A2:6) (720 RPM - 33°)	Inlet	41	48	53	60	62	64	65	59	70
HM 71 T4/T8 1,5/0,25kW (A2:6) (720 RPM - 30°)	Inlet	42	48	54	62	63	65	66	61	71
HM 71 T4/T8 1,5/0,25kW (A2:6) (1420 RPM - 28°)	Inlet	57	64	70	78	80	81	82	77	87
HM 71 T4/T8 1,5/0,25kW (A2:6) (1420 RPM - 33°)	Inlet	57	64	69	76	78	80	81	75	86
HM 71 T4/T8 1,5/0,25kW (A2:6) (1420 RPM - 30°)	Inlet	58	64	70	78	79	81	82	77	87
HM 71 T4/T8 1,5/0,25kW (A2:9) (720 RPM - 25°)	Inlet	44	51	58	65	68	68	69	63	74
HM 71 T4/T8 1,5/0,25kW (A2:9) (1420 RPM - 25°)	Inlet	60	67	74	81	83	84	85	79	90
HM 71 T4/T8 1,5/0,25kW (A5:6) (720 RPM - 30°)	Inlet	46	53	58	67	67	68	69	58	74
HM 71 T4/T8 1,5/0,25kW (A5:6) (1420 RPM - 30°)	Inlet	61	68	73	82	82	83	84	73	89

		Sound power Lw dB (A)								
Model		63 Hz	125 Hz	250 Hz	500 Hz	1000 Hz	2000 Hz	4000 Hz	8000 Hz	Total
HM 71 T4/T8 2,2/0,37kW (A2:6) (720 RPM - 40°)	Inlet	43	50	55	61	64	65	64	58	70
HM 71 T4/T8 2,2/0,37kW (A2:6) (720 RPM - 37°)	Inlet	42	49	54	60	63	64	64	58	70
HM 71 T4/T8 2,2/0,37kW (A2:6) (720 RPM - 35°)	Inlet	41	48	53	59	61	64	64	58	69
HM 71 T4/T8 2,2/0,37kW (A2:6) (1420 RPM - 40°)	Inlet	59	66	71	77	80	81	80	74	86
HM 71 T4/T8 2,2/0,37kW (A2:6) (1420 RPM - 37°)	Inlet	58	65	70	76	78	80	80	74	85
HM 71 T4/T8 2,2/0,37kW (A2:6) (1420 RPM - 35°)	Inlet	57	64	69	75	77	79	80	74	85
HM 71 T4/T8 2,2/0,37kW (A2:9) (720 RPM - 33°)	Inlet	44	51	56	63	66	67	68	62	73
HM 71 T4/T8 2,2/0,37kW (A2:9) (720 RPM - 30°)	Inlet	44	51	56	63	66	67	68	62	73
HM 71 T4/T8 2,2/0,37kW (A2:9) (720 RPM - 28°)	Inlet	44	51	57	64	66	67	68	63	73
HM 71 T4/T8 2,2/0,37kW (A2:9) (1420 RPM - 33°)	Inlet	60	67	72	79	82	83	83	78	89
HM 71 T4/T8 2,2/0,37kW (A2:9) (1420 RPM - 30°)	Inlet	60	67	72	79	82	83	84	78	89
HM 71 T4/T8 2,2/0,37kW (A2:9) (1420 RPM - 28°)	Inlet	60	67	73	80	82	83	84	78	89
HM 71 T4/T8 2,2/0,37kW (A5:6) (720 RPM - 35°)	Inlet	47	54	59	61	65	67	68	57	72
HM 71 T4/T8 2,2/0,37kW (A5:6) (720 RPM - 33°)	Inlet	46	53	58	64	66	68	68	58	73
HM 71 T4/T8 2,2/0,37kW (A5:6) (1420 RPM - 35°)	Inlet	62	69	74	76	80	82	83	72	87
HM 71 T4/T8 2,2/0,37kW (A5:6) (1420 RPM - 33°)	Inlet	62	69	74	79	81	83	84	73	88
HM 71 T4/T8 3/0,55kW (A2:6) (720 RPM - 45°)	Inlet	46	50	58	61	64	65	65	58	71
HM 71 T4/T8 3/0,55kW (A2:6) (720 RPM - 43°)	Inlet	44	50	56	61	64	65	64	58	70
HM 71 T4/T8 3/0,55kW (A2:6) (1420 RPM - 45°)	Inlet	62	66	74	77	80	81	81	74	86
HM 71 T4/T8 3/0,55kW (A2:6) (1420 RPM - 43°)	Inlet	60	66	72	77	80	81	80	74	86
HM 71 T4/T8 3/0,55kW (A2:9) (720 RPM - 37°)	Inlet	45	52	57	63	66	68	67	62	73
HM 71 T4/T8 3/0,55kW (A2:9) (720 RPM - 35°)	Inlet	44	51	56	63	66	68	67	62	73
HM 71 T4/T8 3/0,55kW (A2:9) (1420 RPM - 37°)	Inlet	61	68	73	79	82	83	83	78	89



		Sound power Lw dB (A)								
Model		63 Hz	125 Hz	250 Hz	500 Hz	1000 Hz	2000 Hz	4000 Hz	8000 Hz	Total
HM 71 T4/T8 3/0,55kW (A2:9) (1420 RPM - 35°)	Inlet	60	67	72	79	82	83	83	78	89
HM 71 T4/T8 3/0,55kW (A5:6) (720 RPM - 40°)	Inlet	52	58	64	66	69	70	71	61	76
HM 71 T4/T8 3/0,55kW (A5:6) (720 RPM - 37°)	Inlet	50	56	62	64	67	69	70	59	74
HM 71 T4/T8 3/0,55kW (A5:6) (1420 RPM - 40°)	Inlet	67	73	79	81	84	85	86	76	91
HM 71 T4/T8 3/0,55kW (A5:6) (1420 RPM - 37°)	Inlet	65	71	77	79	82	84	85	74	89
HM 80 T4/T8 1,1/0,18kW (A2:6) (720 RPM - 20°)	Inlet	38	45	55	64	67	67	68	64	73
HM 80 T4/T8 1,1/0,18kW (A2:6) (1420 RPM - 20°)	Inlet	54	61	71	79	83	83	84	79	89
HM 80 T4/T8 1,5/0,25kW (A2:6) (720 RPM - 25°)	Inlet	42	49	56	63	67	67	69	63	73
HM 80 T4/T8 1,5/0,25kW (A2:6) (1420 RPM - 25°)	Inlet	57	64	72	79	83	83	84	79	89
HM 80 T4/T8 1,5/0,25kW (A2:9) (720 RPM - 20°)	Inlet	44	56	61	73	75	74	76	68	81
HM 80 T4/T8 1,5/0,25kW (A2:9) (1420 RPM - 20°)	Inlet	60	72	77	89	91	89	92	84	97
HM 80 T4/T8 2,2/0,37kW (A2:6) (720 RPM - 33°)	Inlet	45	52	57	63	66	68	68	62	73
HM 80 T4/T8 2,2/0,37kW (A2:6) (720 RPM - 30°)	Inlet	44	51	56	63	66	68	68	62	73
HM 80 T4/T8 2,2/0,37kW (A2:6) (720 RPM - 28°)	Inlet	44	51	56	63	66	68	68	62	73
HM 80 T4/T8 2,2/0,37kW (A2:6) (1420 RPM - 33°)	Inlet	61	68	73	79	82	84	84	77	89
HM 80 T4/T8 2,2/0,37kW (A2:6) (1420 RPM - 30°)	Inlet	60	67	72	79	82	84	84	78	89
HM 80 T4/T8 2,2/0,37kW (A2:6) (1420 RPM - 28°)	Inlet	60	67	72	79	82	84	84	78	89
HM 80 T4/T8 2,2/0,37kW (A2:9) (720 RPM - 25°)	Inlet	46	55	60	71	73	72	74	67	79
HM 80 T4/T8 2,2/0,37kW (A2:9) (1420 RPM - 25°)	Inlet	62	71	76	86	89	88	90	83	95
HM 80 T4/T8 3/0,55kW (A2:6) (720 RPM - 35°)	Inlet	46	53	58	63	66	68	68	61	73
HM 80 T4/T8 3/0,55kW (A2:6) (720 RPM - 37°)	Inlet	46	53	58	62	65	67	67	60	72
HM 80 T4/T8 3/0,55kW (A2:6) (1420 RPM - 35°)	Inlet	62	69	74	78	81	84	84	77	89
HM 80 T4/T8 3/0,55kW (A2:6) (1420 RPM - 37°)	Inlet	62	69	74	78	81	83	83	76	88

		Sound power Lw dB (A)								
Model		63 Hz	125 Hz	250 Hz	500 Hz	1000 Hz	2000 Hz	4000 Hz	8000 Hz	Total
HM 80 T4/T8 3/0,55kW (A2:9) (720 RPM - 30°)	Inlet	48	55	60	68	71	72	72	66	77
HM 80 T4/T8 3/0,55kW (A2:9) (720 RPM - 28°)	Inlet	48	55	60	69	72	72	73	67	78
HM 80 T4/T8 3/0,55kW (A2:9) (1420 RPM - 30°)	Inlet	63	70	75	84	87	88	88	82	93
HM 80 T4/T8 3/0,55kW (A2:9) (1420 RPM - 28°)	Inlet	63	71	76	85	88	88	89	82	94
HM 80 T4/T8 3/0,55kW (A5:6) (720 RPM - 35°)	Inlet	47	54	59	64	67	67	71	61	74
HM 80 T4/T8 3/0,55kW (A5:6) (720 RPM - 33°)	Inlet	48	55	60	66	69	69	73	64	76
HM 80 T4/T8 3/0,55kW (A5:6) (720 RPM - 30°)	Inlet	49	56	61	68	72	71	74	68	79
HM 80 T4/T8 3/0,55kW (A5:6) (1420 RPM - 35°)	Inlet	62	69	74	79	82	82	86	76	89
HM 80 T4/T8 3/0,55kW (A5:6) (1420 RPM - 33°)	Inlet	63	70	75	81	85	84	88	80	91
HM 80 T4/T8 3/0,55kW (A5:6) (1420 RPM - 30°)	Inlet	64	71	76	83	87	86	90	83	94
HM 80 T4/T8 4/0,75kW (A2:6) (720 RPM - 43°)	Inlet	46	53	59	62	65	66	66	59	72
HM 80 T4/T8 4/0,75kW (A2:6) (720 RPM - 40°)	Inlet	46	53	58	62	65	66	66	59	72
HM 80 T4/T8 4/0,75kW (A2:6) (1420 RPM - 43°)	Inlet	62	69	75	78	81	82	82	75	88
HM 80 T4/T8 4/0,75kW (A2:6) (1420 RPM - 40°)	Inlet	61	69	74	78	81	82	82	75	88
HM 80 T4/T8 4/0,75kW (A2:9) (720 RPM - 33°)	Inlet	47	54	59	67	70	71	71	65	77
HM 80 T4/T8 4/0,75kW (A2:9) (1420 RPM - 33°)	Inlet	63	70	75	83	86	87	87	81	93
HM 80 T4/T8 4/0,75kW (A5:6) (720 RPM - 37°)	Inlet	49	56	61	65	68	68	71	61	75
HM 80 T4/T8 4/0,75kW (A5:6) (720 RPM - 40°)	Inlet	51	58	63	67	69	69	70	61	76
HM 80 T4/T8 4/0,75kW (A5:6) (1420 RPM - 37°)	Inlet	64	71	76	80	83	83	86	76	90
HM 80 T4/T8 4/0,75kW (A5:6) (1420 RPM - 40°)	Inlet	66	73	78	82	84	84	86	76	91
HM 80 T4/T8 5,5/1,1kW (A2:6) (720 RPM - 45°)	Inlet	46	54	60	63	66	66	66	59	72
HM 80 T4/T8 5,5/1,1kW (A2:6) (1420 RPM - 45°)	Inlet	62	69	75	79	82	82	82	75	88
HM 80 T4/T8 5,5/1,1kW (A2:9) (720 RPM - 40°)	Inlet	48	55	60	65	68	70	70	63	75

		Sound power Lw dB (A)								
Model		63 Hz	125 Hz	250 Hz	500 Hz	1000 Hz	2000 Hz	4000 Hz	8000 Hz	Total
HM 80 T4/T8 5,5/1,1kW (A2:9) (720 RPM - 37°)	Inlet	47	54	59	65	69	71	70	64	76
HM 80 T4/T8 5,5/1,1kW (A2:9) (720 RPM - 35°)	Inlet	47	54	59	65	69	71	70	64	76
HM 80 T4/T8 5,5/1,1kW (A2:9) (1420 RPM - 40°)	Inlet	64	71	76	81	84	86	85	79	91
HM 80 T4/T8 5,5/1,1kW (A2:9) (1420 RPM - 37°)	Inlet	63	70	75	81	85	87	86	80	91
HM 80 T4/T8 5,5/1,1kW (A2:9) (1420 RPM - 35°)	Inlet	62	69	74	81	85	87	86	80	92
HM 90 T4/T8 3/0,55kW (A6:3) (720 RPM - 22°)	Inlet	45	49	57	61	65	66	69	63	73
HM 90 T4/T8 3/0,55kW (A6:3) (1420 RPM - 22°)	Inlet	61	65	73	77	81	82	85	79	89
HM 90 T4/T8 3/0,55kW (A6:3) (1420 RPM - 20°)	Inlet	60	63	72	75	79	80	84	78	87
HM 90 T4/T8 4/0,75kW (A6:3) (720 RPM - 26°)	Inlet	47	52	60	65	67	68	71	65	75
HM 90 T4/T8 4/0,75kW (A6:3) (720 RPM - 24°)	Inlet	47	51	59	63	66	67	70	64	74
HM 90 T4/T8 4/0,75kW (A6:3) (720 RPM - 28°)	Inlet	48	53	61	67	68	69	71	66	76
HM 90 T4/T8 4/0,75kW (A6:3) (1420 RPM - 26°)	Inlet	63	68	76	81	83	84	87	81	91
HM 90 T4/T8 4/0,75kW (A6:3) (1420 RPM - 24°)	Inlet	62	67	75	79	82	83	86	80	90
HM 90 T4/T8 4/0,75kW (A6:3) (1420 RPM - 28°)	Inlet	64	69	77	82	84	85	87	82	92
HM 90 T4/T8 5,5/1,1kW (A6:3) (720 RPM - 30°)	Inlet	49	55	62	68	70	71	72	66	77
HM 90 T4/T8 5,5/1,1kW (A6:3) (720 RPM - 32°)	Inlet	49	55	62	70	70	71	73	67	78
HM 90 T4/T8 5,5/1,1kW (A6:3) (1420 RPM - 30°)	Inlet	65	71	78	84	85	86	88	82	93
HM 90 T4/T8 5,5/1,1kW (A6:3) (1420 RPM - 32°)	Inlet	65	71	78	86	86	87	88	83	94
HM 90 T4/T8 5,5/1,1kW (A6:6) (720 RPM - 22°)	Inlet	50	59	65	73	76	75	75	71	82
HM 90 T4/T8 5,5/1,1kW (A6:6) (1420 RPM - 22°)	Inlet	66	75	81	89	92	91	91	86	97
HM 90 T4/T8 5,5/1,1kW (A6:6) (1420 RPM - 20°)	Inlet	65	75	81	88	92	90	91	86	97
HM 90 T4/T8 7,5/1,5kW (A6:3) (720 RPM - 36°)	Inlet	50	56	63	72	72	73	73	68	79
HM 90 T4/T8 7,5/1,5kW (A6:3) (720 RPM - 34°)	Inlet	50	56	63	71	71	72	73	67	78

Sound power Lw dB (A)										
Model		63 Hz	125 Hz	250 Hz	500 Hz	1000 Hz	2000 Hz	4000 Hz	8000 Hz	Total
HM 90 T4/T8 7,5/1,5kW (A6:3) (1420 RPM - 36°)	Inlet	66	72	79	88	87	89	89	84	95
HM 90 T4/T8 7,5/1,5kW (A6:3) (1420 RPM - 34°)	Inlet	66	72	79	87	87	88	89	83	94
HM 90 T4/T8 7,5/1,5kW (A6:6) (720 RPM - 28°)	Inlet	52	61	67	74	76	76	77	72	83
HM 90 T4/T8 7,5/1,5kW (A6:6) (720 RPM - 26°)	Inlet	52	61	67	74	76	76	77	72	82
HM 90 T4/T8 7,5/1,5kW (A6:6) (720 RPM - 24°)	Inlet	51	60	66	74	76	75	76	71	82
HM 90 T4/T8 7,5/1,5kW (A6:6) (1420 RPM - 28°)	Inlet	68	77	83	90	92	92	93	88	98
HM 90 T4/T8 7,5/1,5kW (A6:6) (1420 RPM - 26°)	Inlet	67	77	82	90	92	91	92	88	98
HM 90 T4/T8 7,5/1,5kW (A6:6) (1420 RPM - 24°)	Inlet	67	76	82	89	92	91	92	87	98
HM 90 T4/T8 11/3kW (A6:3) (720 RPM - 40°)	Inlet	50	58	65	74	74	75	75	70	81
HM 90 T4/T8 11/3kW (A6:3) (720 RPM - 38°)	Inlet	50	58	64	73	73	74	74	69	80
HM 90 T4/T8 11/3kW (A6:3) (1420 RPM - 40°)	Inlet	66	74	81	89	90	91	91	86	97
HM 90 T4/T8 11/3kW (A6:3) (1420 RPM - 38°)	Inlet	66	73	80	89	89	90	90	85	96
HM 90 T4/T8 11/3kW (A6:6) (720 RPM - 34°)	Inlet	50	59	64	71	72	73	75	69	80
HM 90 T4/T8 11/3kW (A6:6) (720 RPM - 32°)	Inlet	52	61	66	73	74	75	76	71	81
HM 90 T4/T8 11/3kW (A6:6) (720 RPM - 30°)	Inlet	53	62	67	75	76	76	77	73	83
HM 90 T4/T8 11/3kW (A6:6) (1420 RPM - 34°)	Inlet	66	75	80	87	88	89	91	85	95
HM 90 T4/T8 11/3kW (A6:6) (1420 RPM - 32°)	Inlet	68	77	82	89	90	90	92	87	97
HM 90 T4/T8 11/3kW (A6:6) (1420 RPM - 30°)	Inlet	69	78	83	90	92	92	93	89	99
HM 90 T4/T8 15/3,5kW (A6:6) (720 RPM - 40°)	Inlet	52	60	65	72	73	74	75	69	80
HM 90 T4/T8 15/3,5kW (A6:6) (720 RPM - 38°)	Inlet	51	60	65	71	72	73	75	69	80
HM 90 T4/T8 15/3,5kW (A6:6) (720 RPM - 36°)	Inlet	50	59	64	70	72	73	74	69	79
HM 90 T4/T8 15/3,5kW (A6:6) (1420 RPM - 40°)	Inlet	68	76	81	88	89	90	91	85	96
HM 90 T4/T8 15/3,5kW (A6:6) (1420 RPM - 38°)	Inlet	67	76	81	87	88	89	91	85	96

		Sound power Lw dB (A)								
Model		63 Hz	125 Hz	250 Hz	500 Hz	1000 Hz	2000 Hz	4000 Hz	8000 Hz	Total
HM 90 T4/T8 15/3,5kW (A6:6) (1420 RPM - 36°)	Inlet	66	75	80	86	88	89	90	85	95
HM 100 T4/T8 5,5/1,1kW (A6:3) (720 RPM - 24°)	Inlet	50	56	62	67	71	73	76	69	79
HM 100 T4/T8 5,5/1,1kW (A6:3) (720 RPM - 26°)	Inlet	50	56	62	67	71	72	75	68	79
HM 100 T4/T8 5,5/1,1kW (A6:3) (1420 RPM - 24°)	Inlet	66	72	78	83	87	88	91	85	95
HM 100 T4/T8 5,5/1,1kW (A6:3) (1420 RPM - 26°)	Inlet	66	72	78	83	87	88	91	84	94
HM 100 T4/T8 5,5/1,1kW (A6:3) (1420 RPM - 20°)	Inlet	64	71	76	81	87	88	92	84	95
HM 100 T4/T8 5,5/1,1kW (A6:3) (1420 RPM - 22°)	Inlet	64	71	76	81	87	88	92	84	95
HM 100 T4/T8 7,5/1,5kW (A6:3) (720 RPM - 30°)	Inlet	50	56	62	68	70	71	73	67	78
HM 100 T4/T8 7,5/1,5kW (A6:3) (720 RPM - 28°)	Inlet	50	56	62	68	71	72	74	68	78
HM 100 T4/T8 7,5/1,5kW (A6:3) (1420 RPM - 30°)	Inlet	66	72	78	84	86	87	89	83	94
HM 100 T4/T8 7,5/1,5kW (A6:3) (1420 RPM - 28°)	Inlet	66	72	78	83	86	88	90	84	94
HM 100 T4/T8 7,5/1,5kW (A6:6) (720 RPM - 22°)	Inlet	53	64	69	79	79	79	79	75	86
HM 100 T4/T8 7,5/1,5kW (A6:6) (1420 RPM - 22°)	Inlet	69	80	85	95	95	95	95	91	102
HM 100 T4/T8 7,5/1,5kW (A6:6) (1420 RPM - 20°)	Inlet	69	80	85	95	96	95	95	91	102
HM 100 T4/T8 11/3kW (A6:3) (720 RPM - 36°)	Inlet	54	59	66	72	74	74	75	70	81
HM 100 T4/T8 11/3kW (A6:3) (720 RPM - 34°)	Inlet	53	59	65	71	73	74	74	69	80
HM 100 T4/T8 11/3kW (A6:3) (720 RPM - 32°)	Inlet	52	57	64	70	72	73	74	68	79
HM 100 T4/T8 11/3kW (A6:3) (1420 RPM - 36°)	Inlet	69	75	82	88	90	90	91	86	96
HM 100 T4/T8 11/3kW (A6:3) (1420 RPM - 34°)	Inlet	69	75	81	87	89	90	90	85	96
HM 100 T4/T8 11/3kW (A6:3) (1420 RPM - 32°)	Inlet	68	73	80	85	87	88	90	84	95
HM 100 T4/T8 11/3kW (A6:6) (720 RPM - 28°)	Inlet	57	65	71	79	79	80	81	76	87
HM 100 T4/T8 11/3kW (A6:6) (720 RPM - 26°)	Inlet	55	65	70	79	79	79	80	75	86
HM 100 T4/T8 11/3kW (A6:6) (720 RPM - 24°)	Inlet	54	64	69	78	79	79	79	75	86

		Sound power Lw dB (A)								
Model		63 Hz	125 Hz	250 Hz	500 Hz	1000 Hz	2000 Hz	4000 Hz	8000 Hz	Total
HM 100 T4/T8 11/3kW (A6:6) (1420 RPM - 28°)	Inlet	73	81	87	95	95	95	96	92	103
HM 100 T4/T8 11/3kW (A6:6) (1420 RPM - 26°)	Inlet	71	81	86	94	95	95	96	91	102
HM 100 T4/T8 11/3kW (A6:6) (1420 RPM - 24°)	Inlet	70	80	85	94	95	95	95	91	102
HM 100 T4/T8 15/3,5kW (A6:3) (720 RPM - 40°)	Inlet	53	61	66	74	75	76	76	71	82
HM 100 T4/T8 15/3,5kW (A6:3) (720 RPM - 38°)	Inlet	53	60	66	73	74	75	75	71	81
HM 100 T4/T8 15/3,5kW (A6:3) (1420 RPM - 40°)	Inlet	69	77	82	90	91	92	92	87	98
HM 100 T4/T8 15/3,5kW (A6:3) (1420 RPM - 38°)	Inlet	69	76	82	89	90	91	91	86	97
HM 100 T4/T8 15/3,5kW (A6:6) (720 RPM - 32°)	Inlet	57	65	71	76	78	78	79	74	85
HM 100 T4/T8 15/3,5kW (A6:6) (720 RPM - 30°)	Inlet	57	65	72	78	79	79	81	76	86
HM 100 T4/T8 15/3,5kW (A6:6) (1420 RPM - 32°)	Inlet	72	80	86	92	94	94	95	90	101
HM 100 T4/T8 15/3,5kW (A6:6) (1420 RPM - 30°)	Inlet	73	81	87	94	95	95	97	92	102
HM 100 T4/T8 17/4,3kW (A6:6) (720 RPM - 36°)	Inlet	55	63	69	73	76	76	78	72	83
HM 100 T4/T8 17/4,3kW (A6:6) (720 RPM - 34°)	Inlet	56	64	70	74	76	77	78	73	83
HM 100 T4/T8 17/4,3kW (A6:6) (1420 RPM - 36°)	Inlet	71	79	85	89	92	92	94	88	99
HM 100 T4/T8 17/4,3kW (A6:6) (1420 RPM - 34°)	Inlet	72	80	86	90	92	93	94	89	99
HM 100 T4/T8 20/5kW (A6:6) (720 RPM - 38°)	Inlet	56	64	70	74	77	77	78	73	84
HM 100 T4/T8 20/5kW (A6:6) (1420 RPM - 38°)	Inlet	72	80	86	90	92	93	94	89	99
HM 112 T4/T8 5,5/1,1kW (A6:3) (720 RPM - 22°)	Inlet	53	60	65	71	76	77	79	74	83
HM 112 T4/T8 5,5/1,1kW (A6:3) (1420 RPM - 22°)	Inlet	69	76	81	87	92	93	95	90	99
HM 112 T4/T8 5,5/1,1kW (A6:3) (1420 RPM - 20°)	Inlet	67	74	79	86	91	92	94	89	99
HM 112 T4/T8 7,5/1,5kW (A6:3) (720 RPM - 26°)	Inlet	55	61	67	73	76	77	80	75	84
HM 112 T4/T8 7,5/1,5kW (A6:3) (720 RPM - 24°)	Inlet	54	61	66	72	76	77	80	74	84
HM 112 T4/T8 7,5/1,5kW (A6:3) (1420 RPM - 26°)	Inlet	71	77	83	89	92	93	96	90	100

		Sound power Lw dB (A)								
Model		63 Hz	125 Hz	250 Hz	500 Hz	1000 Hz	2000 Hz	4000 Hz	8000 Hz	Total
HM 112 T4/T8 7,5/1,5kW (A6:3) (1420 RPM - 24°)	Inlet	70	77	82	88	92	93	95	90	100
HM 112 T4/T8 11/3kW (A6:3) (720 RPM - 30°)	Inlet	55	61	67	73	76	76	79	74	83
HM 112 T4/T8 11/3kW (A6:3) (720 RPM - 28°)	Inlet	55	61	67	73	76	77	79	74	84
HM 112 T4/T8 11/3kW (A6:3) (1420 RPM - 30°)	Inlet	71	77	83	89	92	92	95	90	99
HM 112 T4/T8 11/3kW (A6:3) (1420 RPM - 28°)	Inlet	71	77	83	89	92	93	95	90	100
HM 112 T4/T8 11/3kW (A6:6) (720 RPM - 22°)	Inlet	54	65	70	81	82	81	82	77	88
HM 112 T4/T8 11/3kW (A6:6) (1420 RPM - 22°)	Inlet	70	80	86	96	98	97	98	93	104
HM 112 T4/T8 11/3kW (A6:6) (1420 RPM - 20°)	Inlet	69	80	86	97	98	97	98	93	104
HM 112 T4/T8 15/3,5kW (A6:3) (720 RPM - 34°)	Inlet	57	61	69	74	76	76	78	74	83
HM 112 T4/T8 15/3,5kW (A6:3) (720 RPM - 32°)	Inlet	56	61	68	74	76	76	79	74	83
HM 112 T4/T8 15/3,5kW (A6:3) (720 RPM - 36°)	Inlet	57	62	69	74	76	77	78	74	83
HM 112 T4/T8 15/3,5kW (A6:3) (1420 RPM - 34°)	Inlet	73	77	85	90	92	92	94	90	99
HM 112 T4/T8 15/3,5kW (A6:3) (1420 RPM - 32°)	Inlet	72	77	84	89	92	92	94	90	99
HM 112 T4/T8 15/3,5kW (A6:3) (1420 RPM - 36°)	Inlet	73	78	85	90	92	93	94	90	99
HM 112 T4/T8 15/3,5kW (A6:6) (720 RPM - 26°)	Inlet	57	65	70	79	81	81	82	76	88
HM 112 T4/T8 15/3,5kW (A6:6) (720 RPM - 24°)	Inlet	55	64	70	80	81	80	81	76	87
HM 112 T4/T8 15/3,5kW (A6:6) (720 RPM - 28°)	Inlet	58	66	71	79	81	81	82	76	88
HM 112 T4/T8 15/3,5kW (A6:6) (1420 RPM - 26°)	Inlet	72	81	86	95	97	97	98	92	104
HM 112 T4/T8 15/3,5kW (A6:6) (1420 RPM - 24°)	Inlet	71	80	86	95	97	96	97	92	103
HM 112 T4/T8 15/3,5kW (A6:6) (1420 RPM - 28°)	Inlet	74	82	87	95	97	97	98	92	104
HM 112 T4/T8 17/4,3kW (A6:3) (720 RPM - 38°)	Inlet	57	63	69	75	77	78	78	74	84
HM 112 T4/T8 17/4,3kW (A6:3) (1420 RPM - 38°)	Inlet	73	79	85	91	93	93	94	90	100
HM 112 T4/T8 17/4,3kW (A6:6) (720 RPM - 30°)	Inlet	59	66	71	78	80	81	82	75	87

Sound power Lw dB (A)										
Model		63 Hz	125 Hz	250 Hz	500 Hz	1000 Hz	2000 Hz	4000 Hz	8000 Hz	Total
HM 112 T4/T8 17/4,3kW (A6:6) (1420 RPM - 30°)	Inlet	75	82	87	94	96	97	98	91	103
HM 112 T4/T8 20/5kW (A6:3) (720 RPM - 40°)	Inlet	57	63	69	75	77	78	78	74	84
HM 112 T4/T8 20/5kW (A6:3) (1420 RPM - 40°)	Inlet	73	79	85	91	93	94	94	90	100
HM 112 T4/T8 20/5kW (A6:6) (720 RPM - 32°)	Inlet	59	66	71	77	79	80	81	74	86
HM 112 T4/T8 20/5kW (A6:6) (1420 RPM - 32°)	Inlet	74	81	86	92	95	96	97	90	102
HM 112 T4/T8 28/6,5kW (A6:6) (720 RPM - 38°)	Inlet	61	67	73	77	80	81	82	75	87
HM 112 T4/T8 28/6,5kW (A6:6) (720 RPM - 36°)	Inlet	59	66	71	75	78	80	80	73	86
HM 112 T4/T8 28/6,5kW (A6:6) (720 RPM - 34°)	Inlet	58	65	70	75	78	79	80	73	85
HM 112 T4/T8 28/6,5kW (A6:6) (1420 RPM - 38°)	Inlet	77	83	89	92	96	97	98	91	103
HM 112 T4/T8 28/6,5kW (A6:6) (1420 RPM - 36°)	Inlet	75	82	87	91	94	95	96	89	102
HM 112 T4/T8 28/6,5kW (A6:6) (1420 RPM - 34°)	Inlet	74	81	86	91	94	95	96	89	101
HM 112 T4/T8 35/8kW (A6:6) (720 RPM - 40°)	Inlet	62	69	74	78	81	82	83	76	88
HM 112 T4/T8 35/8kW (A6:6) (1420 RPM - 40°)	Inlet	78	85	90	94	97	98	99	92	104
HM 125 T4/T8 11/3kW (A7:4) (720 RPM - 22°)	Inlet	59	70	75	82	86	87	89	85	93
HM 125 T4/T8 11/3kW (A7:4) (1420 RPM - 22°)	Inlet	75	86	91	98	102	103	105	101	109
HM 125 T4/T8 15/3,5kW (A7:4) (720 RPM - 24°)	Inlet	59	69	74	80	84	85	87	82	91
HM 125 T4/T8 15/3,5kW (A7:4) (720 RPM - 26°)	Inlet	60	68	73	78	82	83	85	80	90
HM 125 T4/T8 15/3,5kW (A7:4) (1420 RPM - 24°)	Inlet	75	85	90	96	100	101	103	98	107
HM 125 T4/T8 15/3,5kW (A7:4) (1420 RPM - 26°)	Inlet	76	84	89	94	98	99	101	95	106
HM 125 T4/T8 15/3,5kW (A7:8) (1420 RPM - 20°)	Inlet	77	85	92	101	107	110	109	104	115
HM 125 T4/T8 17/4,3kW (A7:4) (720 RPM - 28°)	Inlet	59	66	71	77	80	82	83	77	88
HM 125 T4/T8 17/4,3kW (A7:4) (1420 RPM - 28°)	Inlet	75	82	87	92	96	98	99	93	104
HM 125 T4/T8 20/5kW (A7:4) (720 RPM - 30°)	Inlet	58	65	70	74	78	80	81	74	86



		Sound power Lw dB (A)								
Model		63 Hz	125 Hz	250 Hz	500 Hz	1000 Hz	2000 Hz	4000 Hz	8000 Hz	Total
HM 125 T4/T8 20/5kW (A7:4) (1420 RPM - 30°)	Inlet	74	81	86	90	94	96	97	90	102
HM 125 T4/T8 20/5kW (A7:8) (720 RPM - 22°)	Inlet	62	69	75	83	90	93	92	87	97
HM 125 T4/T8 20/5kW (A7:8) (1420 RPM - 22°)	Inlet	77	85	91	99	106	109	108	103	113
HM 125 T4/T8 28/6,5kW (A7:4) (720 RPM - 36°)	Inlet	58	65	70	75	77	79	80	72	85
HM 125 T4/T8 28/6,5kW (A7:4) (720 RPM - 34°)	Inlet	57	64	69	74	77	79	80	72	85
HM 125 T4/T8 28/6,5kW (A7:4) (720 RPM - 32°)	Inlet	58	65	70	74	78	79	80	73	85
HM 125 T4/T8 28/6,5kW (A7:4) (1420 RPM - 36°)	Inlet	74	81	86	90	93	95	96	88	101
HM 125 T4/T8 28/6,5kW (A7:4) (1420 RPM - 34°)	Inlet	73	80	85	90	93	95	96	88	101
HM 125 T4/T8 28/6,5kW (A7:4) (1420 RPM - 32°)	Inlet	74	81	86	90	93	95	96	89	101
HM 125 T4/T8 28/6,5kW (A7:8) (720 RPM - 26°)	Inlet	61	68	74	81	87	90	90	84	95
HM 125 T4/T8 28/6,5kW (A7:8) (720 RPM - 24°)	Inlet	61	68	75	82	89	91	91	85	96
HM 125 T4/T8 28/6,5kW (A7:8) (1420 RPM - 26°)	Inlet	77	84	90	97	103	106	106	99	111
HM 125 T4/T8 28/6,5kW (A7:8) (1420 RPM - 24°)	Inlet	77	84	91	98	105	107	107	101	112
HM 125 T4/T8 35/8kW (A7:4) (720 RPM - 40°)	Inlet	59	66	71	76	78	80	81	74	86
HM 125 T4/T8 35/8kW (A7:4) (720 RPM - 38°)	Inlet	59	66	71	76	78	80	81	73	86
HM 125 T4/T8 35/8kW (A7:4) (1420 RPM - 40°)	Inlet	75	82	87	92	94	96	96	90	102
HM 125 T4/T8 35/8kW (A7:4) (1420 RPM - 38°)	Inlet	75	82	87	91	94	96	96	89	102
HM 125 T4/T8 35/8kW (A7:8) (720 RPM - 30°)	Inlet	61	67	73	79	84	87	87	80	92
HM 125 T4/T8 35/8kW (A7:8) (720 RPM - 28°)	Inlet	61	68	74	80	86	89	89	82	94
HM 125 T4/T8 35/8kW (A7:8) (1420 RPM - 30°)	Inlet	77	83	89	95	100	103	103	96	108
HM 125 T4/T8 35/8kW (A7:8) (1420 RPM - 28°)	Inlet	77	83	90	96	102	105	105	98	110
HM 125 T4/T8 37/9,2kW (A7:8) (720 RPM - 32°)	Inlet	61	67	73	79	83	85	86	78	90
HM 125 T4/T8 37/9,2kW (A7:8) (1420 RPM - 32°)	Inlet	77	83	89	94	99	101	102	94	106

**Sound power Lw dB (A)**

Model		63 Hz	125 Hz	250 Hz	500 Hz	1000 Hz	2000 Hz	4000 Hz	8000 Hz	Total
HM 125 T4/T8 44/11kW (A7:8) (720 RPM - 34°)	Inlet	61	68	73	78	82	84	84	76	89
HM 125 T4/T8 44/11kW (A7:8) (1420 RPM - 34°)	Inlet	77	83	89	94	98	100	100	92	105

## erp data

ERP	
Fan type	Axial fan
Instalation catgory	A
Efficency catgory	Static
The fan has to be installed with FSC	No

## ERP / 2 poles

Model	Motor power (kW)	Maximum efficiency point data						
		Max. efficiency (%)	Efficiency grade (N) (N)	Air Flow (m3/h)	Ps (Pa)	Pabs (kW)	speed (rpm)	Specific ratio
HM 35 M2 0,55kW (A0:6) (°)	0,55	36,32	43,50	2.837,83	322,23	0,74	2800	1,00
HM 35 M2 1,1kW (A0:6) (°)	1,1	36,49	42,85	3.621,61	353,93	0,99	2800	1,00
HM 35 T2 0,55kW (A0:6) (°)	0,55	36,32	43,50	2.837,83	322,23	0,74	2800	1,00
HM 35 T2 1,1kW (A0:6) (°)	1,1	38,92	45,45	3.621,60	353,93	0,93	2800	1,00
HM 40 T2 1,1kW (A0:6) (°)	1,1	39,39	45,28	5.024,53	308,78	1,18	2800	1,00
HM 45 T2 0,75kW (A9:4) (°)	0,75	46,91	53,71	4.310,28	314,71	0,84	2800	1,00
HM 45 T2 1,1kW (A9:4) (°)	1,10	46,55	52,60	5.271,63	334,75	1,11	2800	1,00
HM 45 T2 1,1kW (A9:8) (°)	1,10	45,64	51,05	4.741,96	448,81	1,40	2800	1,00
HM 45 T2 1,5kW (A0:6) (°)	1,5	47,17	52,37	5.963,51	418,46	1,51	2865	1,00
HM 45 T2 1,5kW (A9:4) (°)	1,50	44,47	49,64	6.423,27	373,28	1,53	2865	1,00
HM 45 T2 1,5kW (A9:8) (°)	1,50	44,83	49,51	5.696,27	484,22	1,82	2865	1,00
HM 45 T2 2,2kW (A0:6) (°)	2,2	46,64	50,91	7.736,77	443,93	2,12	2840	1,00
HM 45 T2 2,2kW (A9:4) (°)	2,20	37,57	41,62	8.101,09	380,74	2,29	2840	1,00
HM 45 T2 2,2kW (A9:4) (°)	2,20	42,56	47,27	7.132,50	384,77	1,81	2840	1,00
HM 45 T2 2,2kW (A9:8) (°)	2,20	44,42	48,35	7.127,39	506,76	2,41	2840	1,00
HM 45 T2 3kW (A9:8) (°)	3	42,46	45,85	8.112,16	531,66	2,93	2880	1,00
HM 50 T2 1,1kW (A9:4) (°)	1,10	49,28	55,39	5.399,21	337,76	1,08	2800	1,00
HM 50 T2 1,5kW (A9:4) (°)	1,50	48,40	53,68	6.597,18	373,48	1,47	2865	1,00
HM 50 T2 1,5kW (A9:8) (°)	1,50	46,98	51,64	5.853,32	498,71	1,84	2865	1,00
HM 50 T2 2,2kW (A9:4) (°)	2,20	44,86	48,68	9.379,68	425,34	2,49	2840	1,00
HM 50 T2 2,2kW (A9:4) (°)	2,20	47,95	52,27	8.344,74	419,77	2,08	2840	1,00
HM 50 T2 2,2kW (A9:8) (°)	2,20	49,54	53,41	7.457,24	551,07	2,46	2840	1,00
HM 50 T2 3kW (A9:4) (°)	3	39,74	42,92	10.656,33	421,76	3,16	2880	1,00
HM 50 T2 3kW (A9:8) (°)	3	48	50,96	9.263,73	609,11	3,42	2880	1,00
HM 50 T2 4kW (A9:8) (°)	4	46,56	49,03	10.516,37	625,59	4,09	2880	1,00
HM 56 T2 1,5kW (A9:4) (°)	1,50	51,43	57	6.429,24	368,92	1,32	2865	1,00
HM 56 T2 2,2kW (A9:4) (°)	2,20	51,40	56,03	8.070,68	410,58	1,86	2840	1,00
HM 56 T2 2,2kW (A9:8) (°)	2,20	52,06	56,12	7.296,29	553,72	2,29	2840	1,00



Model	Motor power (kW)	Maximum efficiency point data						
		Max. efficiency (%)	Efficiency grade (N) (N)	Air Flow (m3/h)	Ps (Pa)	Pabs (kW)	speed (rpm)	Specific ratio
HM 56 T2 3kW (A9:4) (°)	3	46,81	49,88	11.755,85	465,47	3,28	2880	1,00
HM 56 T2 3kW (A9:4) (°)	3	49,57	53,22	10.361,31	445,42	2,67	2880	1,00
HM 56 T2 3kW (A9:8) (°)	3	51,25	54,41	9.187,18	604,66	3,18	2880	1,00
HM 56 T2 4kW (A9:4) (°)	4	41,46	43,77	13.782,89	466,05	4,34	2880	1,00
HM 56 T2 4kW (A9:8) (°)	4	50,29	52,50	11.605,40	670,27	4,51	2880	1,00
HM 56 T2 5,5kW (A9:5) (°)	5,50	42,11	43,66	14.789,96	587,21	5,72	2910	1,00
HM 56 T2 5,5kW (A9:10) (°)	5,50	49,94	51,41	12.529,46	799,24	5,89	2910	1,00
HM 56 T2 7,5kW (A9:10) (°)	7,50	47,83	48,66	14.567,84	833,05	7,45	2910	1,00
HM 63 T2 1,5kW (A9:4) (°)	1,50	47,91	52,92	7.321,41	375,79	1,62	2865	1,00
HM 63 T2 2,2kW (A9:4) (°)	2,20	51,22	55,26	9.498,60	434,57	2,31	2840	1,00
HM 63 T2 3kW (A9:4) (°)	3	48,70	51,59	12.584,08	477,43	3,51	2880	1,00
HM 63 T2 3kW (A9:8) (°)	3	51,47	55,01	8.584,66	567,57	2,77	2880	1,00
HM 63 T2 4kW (A9:4) (°)	4	46,55	48,85	14.564,11	492,10	4,36	2880	1,00
HM 63 T2 4kW (A9:8) (°)	4	52,92	55,40	11.067,19	668,78	4,07	2880	1,00
HM 63 T2 5,5kW (A9:10) (°)	5,50	53,13	54,68	12.572,59	821,40	5,72	2910	1,00
HM 63 T2 7,5kW (A9:5) (°)	7,50	48,14	49,53	16.503,71	625,28	6,06	2910	1,00
HM 63 T2 7,5kW (A9:10) (°)	7,50	50,74	51,40	15.692,48	878,86	7,92	2910	1,00
HM 63 T2 11kW (A9:10) (°)	11	50,28	50,36	18.771,12	918,15	10,05	2940	1,00
HM 63 T2 15kW (A9:10) (°)	15	46,56	46,45	22.158,81	937,37	12,94	2935	1,00

**ERP / 4 poles**

Model	Motor power (kW)	Maximum efficiency point data						
		Max. efficiency (%)	Efficiency grade (N) (N)	Air Flow (m3/h)	Ps (Pa)	Pabs (kW)	speed (rpm)	Specific ratio
HM 35 M4 0,12kW (A0:6) (°)	0,12	25,37	36,38	1.882,54	86,41	0,18	1380	1,00
HM 35 T4 0,12kW (A0:6) (°)	0,12	25,37	36,38	1.882,54	86,41	0,18	1400	1,00
HM 40 M4 0,25kW (A0:6) (°)	0,25	29,93	39,71	2.832,37	106,08	0,28	1400	1,00
HM 40 T4 0,25kW (A0:6) (°)	0,25	29,93	39,71	2.832,37	106,08	0,28	1400	1,00
HM 45 M4 0,37kW (A0:6) (°)	0,37	27,90	36,87	4.031,59	88,07	0,38	1400	1,00
HM 45 T4 0,55kW (A0:6) (°)	0,55	32,81	41,31	4.467,33	117,89	0,45	1400	1,00
HM 50 M4 0,55kW (A0:6) (°)	0,55	34,91	42,59	5.600,18	134,36	0,61	1400	1,00
HM 50 T4 0,55kW (A0:6) (°)	0,55	34,91	42,59	5.600,18	134,36	0,61	1400	1,00
HM 56 M4 0,37kW (A5:6) (°)	0,37	39,16	47,30	4.450,98	158,25	0,52	1400	1,00
HM 56 M4 0,55kW (A2:6) (°)	0,55	38,90	46,29	5.079,11	177,41	0,68	1400	1,00
HM 56 M4 0,55kW (A2:6) (°)	0,55	38,89	47,20	4.044,51	159,60	0,48	1400	1,00
HM 56 M4 0,55kW (A5:6) (°)	0,55	40,67	48,26	5.579,79	156,10	0,63	1400	1,00



Model	Motor power (kW)	Maximum efficiency point data						
		Max. efficiency (%)	Efficiency grade (N) (N)	Air Flow (m3/h)	Ps (Pa)	Pabs (kW)	speed (rpm)	Specific ratio
HM 56 T4 0,37kW (A5:6) (°)	0,37	39,16	47,30	4.450,98	158,25	0,52	1400	1,00
HM 56 T4 0,55kW (A2:6) (°)	0,55	38,90	46,29	5.079,11	177,41	0,68	1400	1,00
HM 56 T4 0,55kW (A2:6) (°)	0,55	38,89	47,20	4.044,51	159,60	0,48	1400	1,00
HM 56 T4 0,55kW (A2:9) (°)	0,55	37,73	45,06	4.058,71	213,78	0,69	1400	1,00
HM 56 T4 0,55kW (A5:6) (°)	0,55	40,67	48,26	5.579,79	156,10	0,63	1400	1,00
HM 56 T4 0,75kW (A2:6) (°)	0,75	41,28	47,96	6.535,55	193,03	0,88	1410	1,00
HM 56 T4 0,75kW (A2:6) (°)	0,75	43,09	50,15	6.025,67	189,79	0,77	1410	1,00
HM 56 T4 0,75kW (A2:6) (°)	0,75	43,99	51,28	5.734,45	186,22	0,71	1410	1,00
HM 56 T4 0,75kW (A2:9) (°)	0,75	44,82	51,79	5.157,47	228,92	0,79	1410	1,00
HM 56 T4 0,75kW (A5:6) (°)	0,75	40,86	47,66	7.150,49	165,55	0,84	1410	1,00
HM 56 T4 0,75kW (A5:6) (°)	0,75	42,61	49,73	6.724,10	158,14	0,75	1410	1,00
HM 56 T4 1,1kW (A2:9) (°)	1,1	42,11	47,86	7.380,42	245	1,24	1450	1,00
HM 56 T4 1,1kW (A2:9) (°)	1,1	43,48	49,50	6.869,63	242,32	1,12	1450	1,00
HM 56 T4 1,1kW (A2:9) (°)	1,1	44,95	51,27	6.352,21	239,91	1	1450	1,00
HM 56 T4 1,1kW (A2:9) (°)	1,1	45,64	52,18	5.992,84	236,38	0,92	1450	1,00
HM 56 T4 1,1kW (A5:6) (°)	1,1	38,19	44,24	8.313,94	173,66	1,11	1450	1,00
HM 56 T4 1,1kW (A5:6) (°)	1,1	39,49	46,01	7.592,48	167,07	0,93	1450	1,00
HM 56 T4 1,5kW (A5:6) (°)	1,5	37,56	43,20	9.053,32	177,82	1,28	1440	1,00
HM 63 T4 0,55kW (A2:6) (°)	0,55	40,93	48,54	5.260,91	166,30	0,63	1400	1,00
HM 63 T4 0,75kW (A2:6) (°)	0,75	47,89	54,87	6.888,27	187,16	0,79	1410	1,00
HM 63 T4 0,75kW (A2:9) (°)	0,75	47,89	54,70	5.526,55	241,34	0,84	1410	1,00
HM 63 T4 0,75kW (A5:6) (°)	0,75	48,90	55,52	7.749,60	190,49	0,90	1410	1,00
HM 63 T4 1,1kW (A2:6) (°)	1,1	46,88	52,72	9.219,91	212,37	1,20	1450	1,00
HM 63 T4 1,1kW (A2:6) (°)	1,1	48,85	55,10	8.449,86	206,50	1,03	1450	1,00
HM 63 T4 1,1kW (A2:6) (°)	1,1	49,29	55,79	7.966,26	201,05	0,94	1450	1,00
HM 63 T4 1,1kW (A2:9) (°)	1,1	50,67	56,74	7.174,29	258,99	1,10	1450	1,00
HM 63 T4 1,1kW (A5:6) (°)	1,1	48,36	54,02	9.471,59	223,11	1,28	1450	1,00
HM 63 T4 1,5kW (A2:6) (°)	1,5	41,51	46,36	11.480,66	221,80	1,72	1440	1,00
HM 63 T4 1,5kW (A2:6) (°)	1,5	43,42	48,58	10.729,36	219,84	1,53	1440	1,00
HM 63 T4 1,5kW (A2:6) (°)	1,5	45,36	50,84	9.987,52	218,17	1,37	1440	1,00
HM 63 T4 1,5kW (A2:9) (°)	1,5	47,16	51,95	9.819,66	285,37	1,75	1440	1,00
HM 63 T4 1,5kW (A2:9) (°)	1,5	49,14	54,34	8.876,93	280,13	1,51	1440	1,00
HM 63 T4 1,5kW (A2:9) (°)	1,5	49,93	55,39	8.384,96	273,56	1,37	1440	1,00
HM 63 T4 1,5kW (A5:6) (°)	1,5	44,66	49,73	10.634,82	229,88	1,58	1440	1,00
HM 63 T4 1,5kW (A5:6) (°)	1,5	46,28	51,63	10.049,43	224,61	1,43	1440	1,00
HM 63 T4 2,2kW (A2:6) (°)	2,2	40,27	44,89	12.588,71	211,11	1,87	1435	1,00
HM 63 T4 2,2kW (A2:9) (°)	2,2	42,28	46,13	12.682,54	289,33	2,47	1435	1,00
HM 63 T4 2,2kW (A2:9) (°)	2,2	42,79	46,74	12.282,15	291,76	2,38	1435	1,00



Model	Motor power (kW)	Maximum efficiency point data						
		Max. efficiency (%)	Efficiency grade (N) (N)	Air Flow (m3/h)	Ps (Pa)	Pabs (kW)	speed (rpm)	Specific ratio
HM 63 T4 2,2kW (A2:9) (°)	2,2	44,34	48,55	11.486,98	291,40	2,17	1435	1,00
HM 63 T4 2,2kW (A2:9) (°)	2,2	45,66	50,13	10.690,55	291,58	1,97	1435	1,00
HM 63 T4 2,2kW (A5:6) (°)	2,2	42,15	46,86	11.401	228,88	1,81	1435	1,00
HM 63 T4 2,2kW (A5:6) (°)	2,2	40,29	44,68	12.192,25	230,28	2,03	1435	1,00
HM 63 T4 3kW (A2:9) (°)	3	40,70	44,29	13.704,56	281,82	2,71	1420	1,00
HM 71 T4 0,75KW (A2:6) (°)	0,75	50,66	57,75	6.869,32	190,84	0,76	1410	1,00
HM 71 T4 0,75kW (A5:6) (°)	0,75	49,90	56,29	8.372,10	200,34	0,98	1410	1,00
HM 71 T4 1,1kW (A2:6) (°)	1,1	52,73	58,78	9.220,18	216,65	1,11	1454	1,00
HM 71 T4 1,1kW (A2:9) (°)	1,1	52,93	59,06	7.068,49	271,48	1,07	1450	1,00
HM 71 T4 1,1kW (A5:6) (°)	1,1	48,19	53,62	10.397,53	221,33	1,39	1450	1,00
HM 71 T4 1,5kW (A2:6) (°)	1,5	49,42	54,12	12.767,22	242,94	1,82	1440	1,00
HM 71 T4 1,5kW (A2:6) (°)	1,5	51	56,11	11.661,78	234,90	1,56	1440	1,00
HM 71 T4 1,5kW (A2:6) (°)	1,5	52,09	57,50	10.912,22	229,75	1,40	1440	1,00
HM 71 T4 1,5kW (A2:9) (°)	1,5	54,01	59,15	9.622,26	286,74	1,54	1440	1,00
HM 71 T4 1,5kW (A5:6) (°)	1,5	48,69	53,41	12.484,67	240,66	1,80	1440	1,00
HM 71 T4 2,2kW (A2:6) (°)	2,2	44,69	48,50	15.873,28	248,35	2,51	1435	1,00
HM 71 T4 2,2kW (A2:6) (°)	2,2	46,76	50,85	14.856,44	249,66	2,26	1435	1,00
HM 71 T4 2,2kW (A2:6) (°)	2,2	48,42	52,77	13.900,24	250,94	2,06	1435	1,00
HM 71 T4 2,2kW (A2:9) (°)	2,2	50,87	54,79	13.241,46	315,36	2,41	1435	1,00
HM 71 T4 2,2kW (A2:9) (°)	2,2	52,47	56,76	12.076,33	309,57	2,10	1435	1,00
HM 71 T4 2,2kW (A2:9) (°)	2,2	53,24	57,78	11.364,26	301,56	1,92	1435	1,00
HM 71 T4 2,2kW (A5:6) (°)	2,2	44,44	48,31	14.711,90	256,35	2,46	1435	1,00
HM 71 T4 2,2kW (A5:6) (°)	2,2	46,08	50,34	13.584,40	248,47	2,13	1435	1,00
HM 71 T4 3kW (A2:6) (°)	3	40,79	44,17	17.525,73	237,19	2,93	1420	1,00
HM 71 T4 3kW (A2:9) (°)	3	47,86	51,12	15.671,19	322,48	3,07	1420	1,00
HM 71 T4 3kW (A2:9) (°)	3	49,76	53,34	14.476,09	320,58	2,73	1420	1,00
HM 71 T4 3kW (A5:6) (°)	3	41,28	44,71	16.071,79	257,98	2,89	1420	1,00
HM 71 T4 3kW (A5:6) (°)	3	42,73	46,36	15.385,79	256,45	2,67	1420	1,00
HM 80 T4 1,1KW (A2:6) (°)	1,1	54,76	61,15	8.717,96	212,26	0,98	1450	1,00
HM 80 T4 1,5KW (A2:6) (°)	1,5	55,12	60,30	12.084,38	236,27	1,52	1440	1,00
HM 80 T4 1,5KW (A2:9) (°)	1,5	54,96	60,20	9.312,63	298,57	1,49	1440	1,00
HM 80 T4 2,2kW (A2:6) (°)	2,2	52,93	56,72	16.968,83	270,13	2,53	1435	1,00
HM 80 T4 2,2kW (A2:6) (°)	2,2	54,26	58,46	15.422,24	262,37	2,18	1435	1,00
HM 80 T4 2,2kW (A2:6) (°)	2,2	55,24	59,75	14.418,13	254,06	1,94	1435	1,00
HM 80 T4 2,2kW (A2:9) (°)	2,2	55,64	59,77	12.722,75	323,27	2,24	1435	1,00
HM 80 T4 3kW (A2:6) (°)	3	49,42	52,48	20.023,66	281,83	3,30	1420	1,00
HM 80 T4 3kW (A2:6) (°)	3	52,33	55,77	18.524,04	278,91	2,88	1420	1,00
HM 80 T4 3kW (A2:9) (°)	3	54,50	57,80	16.131,69	341,20	3,03	1420	1,00



Model	Motor power (kW)	Maximum efficiency point data						
		Max. efficiency (%)	Efficiency grade (N) (N)	Air Flow (m3/h)	Ps (Pa)	Pabs (kW)	speed (rpm)	Specific ratio
HM 80 T4 3kW (A2:9) (°)	3	55	58,54	15.084,16	335,23	2,77	1420	1,00
HM 80 T4 3kW (A5:6) (°)	3	49,80	52,77	19.560,26	299,70	3,41	1420	1,00
HM 80 T4 3kW (A5:6) (°)	3	52,36	55,66	18.296,01	296,87	3,02	1420	1,00
HM 80 T4 3kW (A5:6) (°)	3	55,68	59,36	17.060,33	297,05	2,63	1420	1,00
HM 80 T4 4kW (A2:6) (°)	4	44,72	47,25	22.250,17	282,99	4	1440	1,00
HM 80 T4 4kW (A2:6) (°)	4	46,89	49,62	21.482,19	284,61	3,72	1440	1,00
HM 80 T4 4kW (A2:9) (°)	4	48,42	50,73	19.784,99	357,65	4,32	1440	1,00
HM 80 T4 4kW (A2:9) (°)	4	51,81	54,64	17.915,03	349,60	3,60	1440	1,00
HM 80 T4 4kW (A5:6) (°)	4	48,62	51,28	21.096,99	306,23	3,82	1440	1,00
HM 80 T4 4kW (A5:6) (°)	4	47,80	50,18	22.715,02	308,46	4,22	1440	1,00
HM 80 T4 5,5kW (A2:6) (°)	5,5	40,21	42,30	24.071,60	277,60	4,69	1460	1,00
HM 80 T4 5,5kW (A2:9) (°)	5,5	44,93	46,54	23.818,35	368,51	5,61	1460	1,00
HM 80 T4 5,5kW (A2:9) (°)	5,5	46,29	48,05	22.877,51	371,99	5,31	1460	1,00
HM 80 T4 5,5kW (A2:9) (°)	5,5	47,48	49,53	21.293,55	364,53	4,77	1460	1,00
HM 90 T4 3kW (A6:3) (°)	3	49,14	52,47	18.593,33	272,71	2,99	1436	1,00
HM 90 T4 3kW (A6:3) (°)	3	49,24	53,01	17.038,58	253,36	2,54	1447	1,00
HM 90 T4 4kW (A6:3) (°)	4	46,32	48,52	23.127,77	320,19	4,51	1442	1,00
HM 90 T4 4kW (A6:3) (°)	4	47,64	50,20	21.621,45	305,39	3,95	1450	1,00
HM 90 T4 4kW (A6:3) (°)	4	49,02	51,96	20.176,85	290,07	3,44	1458	1,00
HM 90 T4 5,5kW (A6:3) (°)	5,5	42,51	44,07	25.979,43	325,52	5,70	1465	1,00
HM 90 T4 5,5kW (A6:3) (°)	5,5	44,67	46,56	24.523,24	324,85	5,05	1470	1,00
HM 90 T4 5,5kW (A6:6) (°)	5,5	52,09	53,95	20.849,42	427,50	5,10	1469	1,00
HM 90 T4 5,5kW (A6:6) (°)	5,5	52,33	54,63	18.994,33	402,25	4,36	1474	1,00
HM 90 T4 7,5kW (A6:3) (°)	7,5	37,69	38,61	28.887,19	325,88	7,19	1464	1,00
HM 90 T4 7,5kW (A6:3) (°)	7,5	40,44	41,70	27.421,18	326,25	6,36	1469	1,00
HM 90 T4 7,5kW (A6:6) (°)	7,5	49,11	49,82	25.483,88	502,92	7,77	1461	1,00
HM 90 T4 7,5kW (A6:6) (°)	7,5	50,47	51,56	24.007,62	478,74	6,76	1467	1,00
HM 90 T4 7,5kW (A6:6) (°)	7,5	52,03	53,52	22.583,12	453,19	5,86	1472	1,00
HM 90 T4 11kW (A6:6) (°)	11	44,02	44,05	30.278,42	536,63	10,78	1475	1,00
HM 90 T4 11kW (A6:6) (°)	11	45,83	45,93	28.603,97	528,78	9,71	1478	1,00
HM 90 T4 11kW (A6:6) (°)	11	47,73	48,14	27.036,29	517,97	8,68	1481	1,00
HM 90 T4 15kW (A6:6) (°)	15	38,70	38,52	35.693,49	524,48	13,93	1472	1,00
HM 90 T4 15kW (A6:6) (°)	15	40,84	40,73	34.393,14	529,97	12,77	1475	1,00
HM 90 T4 15kW (A6:6) (°)	15	42,56	42,53	32.348,89	530,89	11,68	1478	1,00
HM 100 T4 5,5kW (A6:3) (°)	5,5	51,93	53,44	29.182,08	364,29	5,80	1464	1,00
HM 100 T4 5,5kW (A6:3) (°)	5,5	53,98	55,89	27.115,65	348	5,01	1470	1,00
HM 100 T4 5,5kW (A6:3) (°)	5,5	54,92	57,78	24.876,14	326,93	3,55	1479	1,00
HM 100 T4 5,5kW (A6:3) (°)	5,5	55,26	58,08	22.586,33	303,57	3,60	1479	1,00

Model	Motor power (kW)	Maximum efficiency point data						
		Max. efficiency (%)	Efficiency grade (N) (N)	Air Flow (m3/h)	Ps (Pa)	Pabs (kW)	speed (rpm)	Specific ratio
HM 100 T4 7,5kW (A6:3) (°)	7,5	48,09	48,91	33.404,84	381,28	7,47	1463	1,00
HM 100 T4 7,5kW (A6:3) (°)	7,5	50,50	51,66	31.271,98	379,40	6,61	1468	1,00
HM 100 T4 7,5kW (A6:6) (°)	7,5	55,67	56,47	27.135,33	513,68	7,53	1462	1,00
HM 100 T4 7,5kW (A6:6) (°)	7,5	55,71	56,99	24.343,21	481,25	6,33	1469	1,00
HM 100 T4 11kW (A6:3) (°)	11	40,08	40,13	39.152,83	372,58	10,53	1476	1,00
HM 100 T4 11kW (A6:3) (°)	11	42,98	43,16	37.709,85	376,65	9,43	1479	1,00
HM 100 T4 11kW (A6:3) (°)	11	46	46,52	35.700,53	378,41	8,34	1482	1,00
HM 100 T4 11kW (A6:6) (°)	11	53,63	53,63	35.488,84	574,93	11,11	1474	1,00
HM 100 T4 11kW (A6:6) (°)	11	55,05	55,13	32.630,11	557,41	9,78	1478	1,00
HM 100 T4 11kW (A6:6) (°)	11	55,82	56,24	29.855,14	541,52	8,67	1481	1,00
HM 100 T4 15kW (A6:6) (°)	15	50,07	49,90	40.698,13	591,56	13,95	1472	1,00
HM 100 T4 15kW (A6:6) (°)	15	51,97	51,88	38.100,43	584,23	12,47	1476	1,00
HM 100 T4 18,5kW (A6:6) (°)	18,5	45,61	45,26	45.749,12	601,46	17,37	1472	1,00
HM 100 T4 18,5kW (A6:6) (°)	18,5	48,12	47,86	43.258,41	598,12	15,55	1475	1,00
HM 100 T4 22kW (A6:6) (°)	22	41,11	40,62	50.228,34	595,14	20,96	1471	1,00
HM 100 T4 22kW (A6:6) (°)	22	43,50	43,08	48.316,64	603,86	19,22	1474	1,00
HM 112 T4 5,5kW (A6:3) (°)	5,5	54,25	55,76	30.997,21	358,03	5,82	1460	1,00
HM 112 T4 5,5kW (A6:3) (°)	5,5	52,66	54,65	27.306,06	330,01	4,88	1460	1,00
HM 112 T4 7,5kW (A6:3) (°)	7,5	53,05	53,66	38.016,12	397,60	8,05	1459	1,00
HM 112 T4 7,5kW (A6:3) (°)	7,5	54,90	55,97	34.623,10	381,96	6,82	1466	1,00
HM 112 T4 11kW (A6:3) (°)	11	49,77	49,81	44.242,32	420,80	10,58	1476	1,00
HM 112 T4 11kW (A6:3) (°)	11	51,95	52,16	41.611,52	412,38	9,32	1479	1,00
HM 112 T4 11kW (A6:6) (°)	11	55,93	55,99	34.046,39	574,11	10,34	1476	1,00
HM 112 T4 11kW (A6:6) (°)	11	54,88	55,27	30.082,65	539,13	8,72	1481	1,00
HM 112 T4 15kW (A6:3) (°)	15	42,11	41,87	51.227,83	432,64	15,09	1469	1,00
HM 112 T4 15kW (A6:3) (°)	15	45,05	44,90	49.204,26	432,78	13,44	1473	1,00
HM 112 T4 15kW (A6:3) (°)	15	47,99	47,94	46.861,26	428,16	11,84	1477	1,00
HM 112 T4 15kW (A6:6) (°)	15	56,36	56,09	46.246,85	646,55	15,69	1468	1,00
HM 112 T4 15kW (A6:6) (°)	15	56,60	56,43	42.073,29	625,95	13,77	1473	1,00
HM 112 T4 15kW (A6:6) (°)	15	56,68	56,62	37.975,26	606,49	12	1477	1,00
HM 112 T4 18,5kW (A6:3) (°)	18,5	39,21	38,89	53.213,23	431,91	16,92	1472	1,00
HM 112 T4 18,5kW (A6:6) (°)	18,5	55,23	54,87	49.777,71	670,80	17,71	1471	1,00
HM 112 T4 22kW (A6:6) (°)	22	52,42	51,89	56.927	709,72	22,10	1469	1,00
HM 112 T4 22kW (A6:6) (°)	22	54,11	53,66	53.425,81	693,47	19,83	1473	1,00
HM 112 T4 30kW (A6:6) (°)	30	45,08	44,31	66.879,03	709,13	29,95	1473	1,00
HM 112 T4 30kW (A6:6) (°)	30	47,93	47,23	63.563,76	719,57	27,13	1477	1,00
HM 112 T4 30kW (A6:6) (°)	30	50,27	49,65	60.259,07	714,30	24,46	1480	1,00
HM 125 T4 11kW (A7:4) (°)	11	52,76	52,77	41.381,22	490,92	11,07	1474	1,00



Model	Motor power (kW)	Maximum efficiency point data						
		Max. efficiency (%)	Efficiency grade (N) (N)	Air Flow (m3/h)	Ps (Pa)	Pabs (kW)	speed (rpm)	Specific ratio
HM 125 T4 11kW (A7:4) (°)	11	50,56	50,75	36.598,97	451,89	9,42	1479	1,00
HM 125 T4 15kW (A7:4) (°)	15	53,91	53,68	51.353,96	552,14	15,01	1469	1,00
HM 125 T4 15kW (A7:4) (°)	15	54,08	53,97	46.299,44	524,29	12,87	1475	1,00
HM 125 T4 15kW (A7:8) (°)	15	52,26	51,99	39.157,13	716,62	15,77	1468	1,00
HM 125 T4 18,5kW (A7:4) (°)	18,5	52,29	51,84	60.854,33	594,58	19,69	1467	1,00
HM 125 T4 18,5kW (A7:4) (°)	18,5	53,91	53,56	56.643,01	578,72	17,27	1472	1,00
HM 125 T4 18,5kW (A7:8) (°)	18,5	53,09	52,68	44.346,10	765,42	18,80	1469	1,00
HM 125 T4 22kW (A7:4) (°)	22	50,53	49,99	65.025,18	610,99	22,31	1469	1,00
HM 125 T4 22kW (A7:8) (°)	22	53,73	53,20	49.919,85	809,99	22,10	1469	1,00
HM 125 T4 30kW (A7:4) (°)	30	45,11	44,38	72.444,23	614,48	28,19	1475	1,00
HM 125 T4 30kW (A7:4) (°)	30	48,16	47,52	68.749,63	620,53	25,10	1479	1,00
HM 125 T4 30kW (A7:8) (°)	30	55,29	54,54	62.225,48	888,81	29,39	1474	1,00
HM 125 T4 30kW (A7:8) (°)	30	54,82	54,18	56.057,61	847,78	25,48	1479	1,00
HM 125 T4 37kW (A7:8) (°)	37	53,08	52,14	72.689,59	929,84	37,24	1477	1,00
HM 125 T4 37kW (A7:8) (°)	37	54,34	53,49	67.473,87	910,36	33,08	1480	1,00
HM 125 T4 45kW (A7:8) (°)	45	50,43	49,32	83.131,28	959,99	46,25	1476	1,00
HM 125 T4 45kW (A7:8) (°)	45	51,54	50,52	77.693,38	950,51	41,53	1479	1,00

**ERP / 6 poles**

Model	Motor power (kW)	Maximum efficiency point data						
		Max. efficiency (%)	Efficiency grade (N) (N)	Air Flow (m3/h)	Ps (Pa)	Pabs (kW)	speed (rpm)	Specific ratio
HM 45 M6 0,13kW (A0:6) (°)	0,13	26,43	37,91	2.887,40	49,55	0,15	920	1,00
HM 45 T6 0,13kW (A0:6) (°)	0,13	26,43	37,91	2.887,40	49,55	0,15	920	1,00
HM 50 M6 0,13kW (A0:6) (°)	0,13	29,27	40,04	3.636,18	56,31	0,20	920	1,00
HM 50 T6 0,13kW (A0:6) (°)	0,13	29,27	40,04	3.636,18	56,31	0,20	920	1,00
HM 56 M6 0,25kW (A2:6) (°)	0,55	32,40	41,73	4.575,43	82,53	0,33	870	1,00
HM 56 M6 0,25kW (A2:6) (°)	0,55	31,22	40,30	4.886,93	82,18	0,37	870	1,00
HM 56 M6 0,25kW (A2:6) (°)	0,55	33,70	43,39	4.236,90	81,15	0,29	870	1,00
HM 56 M6 0,25kW (A2:6) (°)	0,55	35,18	45,24	3.905,40	79,61	0,26	870	1,00
HM 56 M6 0,25kW (A2:6) (°)	0,55	35,98	46,28	3.720,36	78,10	0,24	870	1,00
HM 56 M6 0,25kW (A2:6) (°)	0,55	37,78	48,65	3.290,52	74,56	0,19	870	1,00
HM 56 M6 0,25kW (A2:6) (°)	0,55	37,73	49,53	2.618,06	67,01	0,14	870	1,00
HM 56 M6 0,25kW (A5:6) (°)	0,25	28,82	37,81	4.864,42	77,53	0,38	870	1,00
HM 56 M6 0,25kW (A5:6) (°)	0,25	27,74	36,93	4.582,34	72,80	0,35	870	1,00
HM 56 M6 0,25kW (A5:6) (°)	0,25	26,78	36,19	4.271,14	68,72	0,33	870	1,00



Model	Motor power (kW)	Maximum efficiency point data						
		Max. efficiency (%)	Efficiency grade (N) (N)	Air Flow (m3/h)	Ps (Pa)	Pabs (kW)	speed (rpm)	Specific ratio
HM 56 M6 0,37kW (A5:6) (°)	0,37	30,31	39,11	5.318,94	80,35	0,41	890	1,00
HM 56 M6 0,37kW (A5:6) (°)	0,37	31,90	40,51	5.744,66	83,54	0,44	890	1,00
HM 56 T6 0,25kW (A5:6) (°)	0,25	28,82	37,81	4.864,42	77,53	0,38	900	1,00
HM 56 T6 0,25kW (A5:6) (°)	0,25	27,74	36,93	4.582,34	72,80	0,35	900	1,00
HM 56 T6 0,25kW (A5:6) (°)	0,25	26,78	36,19	4.271,14	68,72	0,33	900	1,00
HM 56 T6 0,37kW (A5:6) (°)	0,37	30,31	39,11	5.318,94	80,35	0,41	900	1,00
HM 56 T6 0,37kW (A5:6) (°)	0,37	31,90	40,51	5.744,66	83,54	0,44	900	1,00
HM 56 T6 0,55kW (A2:6) (°)	0,55	37,73	49,53	2.618,06	67,01	0,14	991	1,00
HM 56 T6 0,55kW (A2:6) (°)	0,55	37,78	48,65	3.290,52	74,56	0,19	987	1,00
HM 56 T6 0,55kW (A2:6) (°)	0,55	35,98	46,28	3.720,36	78,10	0,24	984	1,00
HM 56 T6 0,55kW (A2:6) (°)	0,55	35,18	45,24	3.905,40	79,61	0,26	983	1,00
HM 56 T6 0,55kW (A2:6) (°)	0,55	33,70	43,39	4.236,90	81,15	0,29	980	1,00
HM 56 T6 0,55kW (A2:6) (°)	0,55	32,40	41,73	4.575,43	82,53	0,33	977	1,00
HM 56 T6 0,55kW (A2:6) (°)	0,55	31,22	40,30	4.886,93	82,18	0,37	974	1,00
HM 56 T6 0,55kW (A2:6) (°)	0,55	30,06	38,88	5.202,33	82,13	0,40	972	1,00
HM 56 T6 0,55kW (A2:9) (°)	0,55	34,84	44,04	4.113,59	100,74	0,35	900	1,00
HM 56 T6 0,55kW (A2:9) (°)	0,55	35,37	44,80	3.880,39	99,20	0,32	900	1,00
HM 56 T6 0,55kW (A2:9) (°)	0,55	36,53	46,51	3.341,50	95,93	0,26	900	1,00
HM 56 T6 0,55kW (A2:9) (°)	0,55	36,62	47,44	2.632,92	89,63	0,19	900	1,00
HM 56 T6 0,55kW (A2:9) (°)	0,55	30,10	38,18	5.461,11	101,52	0,53	900	1,00
HM 56 T6 0,55kW (A2:9) (°)	0,55	31,38	39,73	5.119,29	102,25	0,48	900	1,00
HM 56 T6 0,55kW (A2:9) (°)	0,55	32,66	41,27	4.788,49	102,55	0,43	900	1,00
HM 56 T6 0,55kW (A2:9) (°)	0,55	33,76	42,65	4.449,87	101,65	0,39	900	1,00
HM 56 T6 0,55kW (A2:9) (°)	0,55	27,60	35,17	6.102,14	102,89	0,64	900	1,00
HM 56 T6 0,55kW (A2:9) (°)	0,55	29,34	37,26	5.649,54	101,96	0,56	900	1,00
HM 63 M6 0,37kW (A5:6) (°)	0,37	34,33	42,68	7.125,79	79,11	0,48	890	1,00
HM 63 M6 0,55kW (A2:9) (°)	0,55	33,38	40,37	7.444,91	122,36	0,79	890	1,00
HM 63 M6 0,55kW (A2:9) (°)	0,55	34,53	41,78	6.937,81	122,53	0,72	890	1,00
HM 63 M6 0,55kW (A2:9) (°)	0,55	35,99	43,62	6.350,37	119,73	0,62	890	1,00
HM 63 M6 0,55kW (A2:9) (°)	0,55	37,71	45,75	5.763,40	117,74	0,54	890	1,00
HM 63 M6 0,55kW (A2:9) (°)	0,55	38,17	46,46	5.426,28	114,90	0,49	890	1,00
HM 63 M6 0,55kW (A2:9) (°)	0,55	39,37	48,31	4.652,77	108,59	0,39	890	1,00
HM 63 M6 0,55kW (A2:9) (°)	0,55	39,08	48,90	3.579,19	101,46	0,28	890	1,00
HM 63 M6 0,55kW (A5:6) (°)	0,55	34,80	42,77	7.553,35	87,18	0,55	890	1,00
HM 63 M6 0,55kW (A5:6) (°)	0,55	35,49	43,12	7.980,88	94,79	0,62	890	1,00
HM 63 T6 0,37kW (A5:6) (°)	0,37	34,33	42,68	7.125,79	79,11	0,48	900	1,00
HM 63 T6 0,55kW (A2:9) (°)	0,55	33,38	40,37	7.444,91	122,36	0,79	900	1,00
HM 63 T6 0,55kW (A2:9) (°)	0,55	34,53	41,78	6.937,81	122,53	0,72	900	1,00



Model	Motor power (kW)	Maximum efficiency point data						
		Max. efficiency (%)	Efficiency grade (N) (N)	Air Flow (m3/h)	Ps (Pa)	Pabs (kW)	speed (rpm)	Specific ratio
HM 63 T6 0,55kW (A2:9) (°)	0,55	35,99	43,62	6.350,37	119,73	0,62	900	1,00
HM 63 T6 0,55kW (A2:9) (°)	0,55	37,71	45,75	5.763,40	117,74	0,54	900	1,00
HM 63 T6 0,55kW (A2:9) (°)	0,55	38,17	46,46	5.426,28	114,90	0,49	900	1,00
HM 63 T6 0,55kW (A2:9) (°)	0,55	39,37	48,31	4.652,77	108,59	0,39	900	1,00
HM 63 T6 0,55kW (A2:9) (°)	0,55	39,08	48,90	3.579,19	101,46	0,28	900	1,00
HM 63 T6 0,55kW (A5:6) (°)	0,55	34,80	42,77	7.553,35	87,18	0,55	900	1,00
HM 63 T6 0,55kW (A5:6) (°)	0,55	35,49	43,12	7.980,88	94,79	0,62	900	1,00
HM 63 T6 0,75kW (A2:9) (°)	0,75	36,84	43,73	8.888,20	118,82	0,82	925	1,00
HM 63 T6 0,75kW (A2:9) (°)	0,75	39,18	46,45	7.944,08	122,86	0,71	925	1,00
HM 71 M6 0,55kW (A2:6) (°)	0,55	35,11	41,99	9.639,37	104,36	0,82	890	1,00
HM 71 M6 0,55kW (A2:6) (°)	0,55	36,48	43,62	9.000,05	106,02	0,75	890	1,00
HM 71 M6 0,55kW (A2:6) (°)	0,55	37,74	45,27	8.264,30	102,16	0,65	890	1,00
HM 71 M6 0,55kW (A2:6) (°)	0,55	39,08	47,01	7.544,57	98,89	0,56	890	1,00
HM 71 M6 0,55kW (A2:6) (°)	0,55	39,83	48,07	7.059,87	96,95	0,50	890	1,00
HM 71 M6 0,55kW (A2:6) (°)	0,55	41,04	49,96	5.975,43	91,17	0,39	890	1,00
HM 71 M6 0,55kW (A2:6) (°)	0,55	41,40	51,50	4.446,72	80,22	0,25	890	1,00
HM 71 M6 0,55kW (A2:9) (°)	0,55	41	50	4.573,69	114,08	0,38	890	1,00
HM 71 M6 0,55kW (A2:9) (°)	0,55	41,36	49,34	6.232,52	120,80	0,55	890	1,00
HM 71 M6 0,55kW (A2:9) (°)	0,55	39,99	47,33	7.341,10	127	0,69	890	1,00
HM 71 M6 0,55kW (A2:9) (°)	0,55	39,35	46,43	7.802,30	129,68	0,76	890	1,00
HM 71 T6 0,55kW (A2:6) (°)	0,55	35,11	41,99	9.639,37	104,36	0,82	900	1,00
HM 71 T6 0,55kW (A2:6) (°)	0,55	36,48	43,62	9.000,05	106,02	0,75	900	1,00
HM 71 T6 0,55kW (A2:6) (°)	0,55	37,74	45,27	8.264,30	102,16	0,65	900	1,00
HM 71 T6 0,55kW (A2:6) (°)	0,55	39,08	47,01	7.544,57	98,89	0,56	900	1,00
HM 71 T6 0,55kW (A2:6) (°)	0,55	39,83	48,07	7.059,87	96,95	0,50	900	1,00
HM 71 T6 0,55kW (A2:6) (°)	0,55	41,04	49,96	5.975,43	91,17	0,39	900	1,00
HM 71 T6 0,55kW (A2:6) (°)	0,55	41,40	51,50	4.446,72	80,22	0,25	900	1,00
HM 71 T6 0,55kW (A2:9) (°)	0,55	41	50	4.573,69	114,08	0,38	900	1,00
HM 71 T6 0,55kW (A2:9) (°)	0,55	41,36	49,34	6.232,52	120,80	0,55	900	1,00
HM 71 T6 0,55kW (A2:9) (°)	0,55	39,99	47,33	7.341,10	127	0,69	900	1,00
HM 71 T6 0,55kW (A2:9) (°)	0,55	39,35	46,43	7.802,30	129,68	0,76	900	1,00
HM 71 T6 0,75kW (A2:6) (°)	0,75	36,78	43,46	11.362,70	99,33	0,88	925	1,00
HM 71 T6 0,75kW (A2:6) (°)	0,75	40,74	47,87	10.283,96	104,14	0,75	925	1,00
HM 71 T6 0,75kW (A2:9) (°)	0,75	43,18	49,72	10.144,23	135,39	0,92	925	1,00
HM 71 T6 0,75kW (A2:9) (°)	0,75	44,96	51,82	9.376,53	134,55	0,82	925	1,00
HM 71 T6 0,75kW (A2:9) (°)	0,75	46,42	53,65	8.589,10	131,97	0,72	925	1,00
HM 71 T6 0,75kW (A5:6) (°)	0,75	31,91	38,41	10.328,24	101,24	0,94	925	1,00
HM 71 T6 0,75kW (A5:6) (°)	0,75	33,55	40,29	9.840,66	100,67	0,86	925	1,00

Model	Motor power (kW)	Maximum efficiency point data						
		Max. efficiency (%)	Efficiency grade (N) (N)	Air Flow (m3/h)	Ps (Pa)	Pabs (kW)	speed (rpm)	Specific ratio
HM 71 T6 0,75kW (A5:6) (°)	0,75	35,49	42,50	9.362,64	103,18	0,78	925	1,00
HM 71 T6 1,1kW (A2:9) (°)	1,1	38,91	44,78	12.244,32	131,81	1,18	925	1,00
HM 71 T6 1,1kW (A2:9) (°)	1,1	41,46	47,63	11.326,60	134,81	1,06	925	1,00
HM 71 T6 1,1kW (A2:9) (°)	1,1	42,70	49	10.946,69	135,89	1,01	925	1,00
HM 80 T6 0,75kW (A2:6) (°)	0,75	47,33	54,05	12.022	117,04	0,87	925	1,00
HM 80 T6 0,75kW (A2:6) (°)	0,75	48,60	55,71	11.007,98	113,61	0,75	925	1,00
HM 80 T6 0,75kW (A2:6) (°)	0,75	49,45	56,97	9.995,22	109,62	0,65	925	1,00
HM 80 T6 0,75kW (A2:6) (°)	0,75	50,48	58,31	9.327,07	106,90	0,58	925	1,00
HM 80 T6 0,75kW (A2:6) (°)	0,75	51,21	59,75	7.840	98,60	0,45	925	1,00
HM 80 T6 0,75kW (A2:6) (°)	0,75	51,65	61,44	5.659,76	88,98	0,28	925	1,00
HM 80 T6 0,75kW (A2:9) (°)	0,75	49,16	55,74	10.452,65	142,94	0,91	925	1,00
HM 80 T6 0,75kW (A2:9) (°)	0,75	49,68	56,51	9.763,49	141,33	0,83	925	1,00
HM 80 T6 0,75kW (A2:9) (°)	0,75	50,78	58,23	8.247,01	135,76	0,67	925	1,00
HM 80 T6 0,75kW (A2:9) (°)	0,75	51,15	59,75	6.039,64	125,58	0,44	925	1,00
HM 80 T6 0,75kW (A5:6) (°)	0,75	48,82	55,52	11.351,24	130,06	0,87	925	1,00
HM 80 T6 1,1kW (A2:6) (°)	1,1	40,97	46,83	14.413,14	118,38	1,19	925	1,00
HM 80 T6 1,1kW (A2:6) (°)	1,1	42,97	49,02	13.905,12	119,50	1,10	925	1,00
HM 80 T6 1,1kW (A2:6) (°)	1,1	45,63	52,06	12.932,13	118,34	0,97	925	1,00
HM 80 T6 1,1kW (A2:9) (°)	1,1	44,35	50	12.800,43	150,44	1,28	925	1,00
HM 80 T6 1,1kW (A2:9) (°)	1,1	47,56	53,72	11.618,99	147,10	1,07	925	1,00
HM 80 T6 1,1kW (A5:6) (°)	1,1	48,07	54,43	12.170,74	135,71	0,99	925	1,00
HM 80 T6 1,1kW (A5:6) (°)	1,1	47,76	53,81	12.992,65	140,55	1,11	925	1,00
HM 80 T6 1,5kW (A2:6) (°)	1,5	37,05	42,50	15.583,74	116,39	1,38	940	1,00
HM 80 T6 1,5kW (A2:9) (°)	1,5	41,39	46,35	15.398,36	154,31	1,65	940	1,00
HM 80 T6 1,5kW (A2:9) (°)	1,5	42,82	47,92	14.809,78	156,28	1,56	940	1,00
HM 80 T6 1,5kW (A2:9) (°)	1,5	44,17	49,57	13.839,19	153,38	1,40	940	1,00
HM 80 T6 1,5kW (A5:6) (°)	1,5	45,66	51,42	13.963,94	139,11	1,23	940	1,00
HM 80 T6 1,5kW (A5:6) (°)	1,5	44,04	49,53	14.943,38	138,87	1,36	940	1,00
HM 80 T6 2,2kW (A2:9) (°)	2,2	39,15	43,82	16.841,74	150,78	1,84	965	1,00
HM 80 T6 2,2kW (A5:6) (°)	2,2	37,82	42,75	16.483,69	133,86	1,67	965	1,00
HM 90 T6 1,5kW (A6:3) (°)	1,5	39,35	44,27	16.809,08	136,87	1,67	949	1,00
HM 90 T6 1,5kW (A6:3) (°)	1,5	41,34	46,58	15.917,03	136,16	1,49	956	1,00
HM 90 T6 1,5kW (A6:3) (°)	1,5	42,43	47,96	14.944,10	135,05	1,34	961	1,00
HM 90 T6 1,5kW (A6:3) (°)	1,5	43,55	49,45	13.995,03	128,23	1,17	967	1,00
HM 90 T6 1,5kW (A6:3) (°)	1,5	45,04	51,32	13.102,42	121,72	1,02	972	1,00
HM 90 T6 1,5kW (A6:3) (°)	1,5	44,19	50,81	12.040,66	114	0,90	976	1,00
HM 90 T6 1,5kW (A6:3) (°)	1,5	46,53	53,71	11.049,13	106,04	0,73	981	1,00
HM 90 T6 1,5kW (A6:6) (°)	1,5	47,78	52,60	14.647,73	190,42	1,74	946	1,00



Model	Motor power (kW)	Maximum efficiency point data						
		Max. efficiency (%)	Efficiency grade (N) (N)	Air Flow (m3/h)	Ps (Pa)	Pabs (kW)	speed (rpm)	Specific ratio
HM 90 T6 1,5kW (A6:6) (°)	1,5	48,29	53,50	13.505,88	180,16	1,50	955	1,00
HM 90 T6 1,5kW (A6:6) (°)	1,5	48,31	53,96	12.310,53	168,90	1,28	963	1,00
HM 90 T6 2,2kW (A6:3) (°)	2,2	32,77	36,74	19.695,80	135,90	2,36	970	1,00
HM 90 T6 2,2kW (A6:3) (°)	2,2	35,24	39,56	18.724,46	136,48	2,09	974	1,00
HM 90 T6 2,2kW (A6:3) (°)	2,2	37,87	42,52	17.780,14	136,86	1,85	977	1,00
HM 90 T6 2,2kW (A6:6) (°)	2,2	44,25	48,02	17.521,81	217,17	2,55	967	1,00
HM 90 T6 2,2kW (A6:6) (°)	2,2	45,84	49,93	16.508,24	211,14	2,26	971	1,00
HM 90 T6 2,2kW (A6:6) (°)	2,2	47,31	51,79	15.582,28	200,59	1,97	976	1,00
HM 90 T6 3kW (A6:6) (°)	3	39,76	42,73	20.938,71	223,55	3,41	963	1,00
HM 90 T6 3kW (A6:6) (°)	3	41,37	44,59	19.650,23	224,54	3,12	967	1,00
HM 90 T6 3kW (A6:6) (°)	3	43,13	46,63	18.538,35	222,48	2,81	971	1,00
HM 90 T6 4kW (A6:6) (°)	4	36,53	39,06	23.107,01	219,93	4,01	968	1,00
HM 90 T6 4kW (A6:6) (°)	4	38,59	41,36	22.286,60	222,21	3,67	971	1,00
HM 100 T6 1,5kW (A6:3) (°)	1,5	48,13	53	18.925,84	152,83	1,71	947	1,00
HM 100 T6 1,5kW (A6:3) (°)	1,5	49,88	55,15	17.589,13	145,98	1,48	956	1,00
HM 100 T6 1,5kW (A6:3) (°)	1,5	50,86	56,56	16.135,36	137,29	1,26	964	1,00
HM 100 T6 1,5kW (A6:3) (°)	1,5	51,16	57,33	14.633,57	127,64	1,06	971	1,00
HM 100 T6 2,2kW (A6:3) (°)	1,5	48,13	53	18.925,84	152,83	1,71	947	1,00
HM 100 T6 2,2kW (A6:3) (°)	1,5	49,88	55,15	17.589,13	145,98	1,48	956	1,00
HM 100 T6 2,2kW (A6:3) (°)	1,5	50,86	56,56	16.135,36	137,29	1,26	964	1,00
HM 100 T6 2,2kW (A6:3) (°)	1,5	51,16	57,33	14.633,57	127,64	1,06	971	1,00
HM 100 T6 2,2kW (A6:3) (°)	2,2	42,52	46,40	23.101,11	158,96	2,45	969	1,00
HM 100 T6 2,2kW (A6:3) (°)	2,2	45	49,21	21.655,26	159,68	2,17	973	1,00
HM 100 T6 2,2kW (A6:3) (°)	2,2	47,28	51,82	20.251,64	159,59	1,92	976	1,00
HM 100 T6 2,2kW (A6:6) (°)	2,2	51,77	55,54	19.371,57	226,97	2,55	967	1,00
HM 100 T6 2,2kW (A6:6) (°)	2,2	52,06	56,24	17.553,65	216,02	2,19	972	1,00
HM 100 T6 2,2kW (A6:6) (°)	2,2	52,24	56,90	15.778	202,55	1,84	977	1,00
HM 100 T6 3kW (A6:3) (°)	3	37,64	40,92	25.341,47	156,32	3,05	968	1,00
HM 100 T6 3kW (A6:3) (°)	3	40,48	44,07	24.437,67	158,30	2,73	972	1,00
HM 100 T6 3kW (A6:6) (°)	3	50,38	53,51	22.985,89	241,37	3,22	965	1,00
HM 100 T6 3kW (A6:6) (°)	3	51,77	55,25	21.130,05	233,99	2,83	971	1,00
HM 100 T6 4kW (A6:6) (°)	4	47,35	49,86	26.363,33	248,26	4,02	968	1,00
HM 100 T6 4kW (A6:6) (°)	4	49,19	52,02	24.663,05	244,95	3,58	972	1,00
HM 100 T6 5,5kW (A6:6) (°)	5,5	41,40	43,06	31.327,21	253,54	5,50	967	1,00
HM 100 T6 5,5kW (A6:6) (°)	5,5	43,59	45,54	29.655,60	251,84	4,94	970	1,00
HM 100 T6 5,5kW (A6:6) (°)	5,5	45,94	48,19	28.013,51	251,12	4,44	974	1,00
HM 100 T6 7,5kW (A6:6) (°)	7,5	39,55	41	32.552,02	249,75	5,93	980	1,00
HM 112 T6 2,2kW (A6:3) (°)	2,2	49,71	53,71	24.666,23	166,82	2,34	970	1,00



Model	Motor power (kW)	Maximum efficiency point data						
		Max. efficiency (%)	Efficiency grade (N) (N)	Air Flow (m3/h)	Ps (Pa)	Pabs (kW)	speed (rpm)	Specific ratio
HM 112 T6 2,2kW (A6:3) (°)	2,2	51,43	55,89	22.448,74	160,06	1,98	975	1,00
HM 112 T6 2,2kW (A6:3) (°)	2,2	50,13	54,99	20.083,71	150,52	1,71	979	1,00
HM 112 T6 2,2kW (A6:3) (°)	2,2	48,67	54,01	17.663,44	138,88	1,43	983	1,00
HM 112 T6 2,2kW (A6:6) (°)	2,2	50,77	54,53	19.469,18	226,39	2,56	967	1,00
HM 112 T6 3kW (A6:3) (°)	3	44,65	47,58	30.325,90	179,95	3,46	962	1,00
HM 112 T6 3kW (A6:3) (°)	3	46,88	50,15	28.670,07	177,02	3,06	968	1,00
HM 112 T6 3kW (A6:3) (°)	3	48,85	52,46	26.933,70	173,25	2,69	972	1,00
HM 112 T6 3kW (A6:6) (°)	3	52,74	55,63	24.619,37	254,58	3,51	961	1,00
HM 112 T6 3kW (A6:6) (°)	3	52,55	55,88	22.033,24	241,42	2,99	968	1,00
HM 112 T6 4kW (A6:3) (°)	4	39,73	42,04	33.163,20	181,48	4,34	964	1,00
HM 112 T6 4kW (A6:3) (°)	4	42,56	45,18	31.869,26	181,68	3,86	969	1,00
HM 112 T6 4kW (A6:6) (°)	4	53,34	55,54	29.954	271,77	4,52	962	1,00
HM 112 T6 4kW (A6:6) (°)	4	53,43	55,98	27.277,52	262,50	3,97	968	1,00
HM 112 T6 5,5kW (A6:6) (°)	5,5	51,38	52,95	34.613,85	291,08	5,68	965	1,00
HM 112 T6 5,5kW (A6:6) (°)	5,5	52,72	54,62	32.264,04	281,42	5,04	970	1,00
HM 112 T6 7,5kW (A6:6) (°)	7,5	45,84	46,57	41.197,43	302,20	7,72	973	1,00
HM 112 T6 7,5kW (A6:6) (°)	7,5	48,09	49,11	39.059,20	299,94	6,96	976	1,00
HM 112 T6 7,5kW (A6:6) (°)	7,5	50,50	51,81	36.917,55	298,05	6,25	979	1,00
HM 112 T6 11kW (A6:6) (°)	11	43,54	44,04	43.201,03	298,10	8,41	979	1,00
HM 125 T6 3kW (A7:4) (°)	3	49,56	52,70	26.786,32	206,52	3,20	966	1,00
HM 125 T6 3kW (A7:4) (°)	3	47,66	51,24	23.707,37	190,07	2,72	972	1,00
HM 125 T6 4kW (A7:4) (°)	4	50,89	53,21	33.253,17	231,61	4,32	964	1,00
HM 125 T6 4kW (A7:4) (°)	4	51,11	53,86	29.962,16	220,31	3,70	971	1,00
HM 125 T6 5,5kW (A7:4) (°)	5,5	49,87	51,48	39.379,74	250,06	5,60	966	1,00
HM 125 T6 5,5kW (A7:4) (°)	5,5	51,47	53,43	36.692,25	243,05	4,92	971	1,00
HM 125 T6 5,5kW (A7:8) (°)	5,5	50,62	52,36	28.758,19	320,60	5,35	968	1,00
HM 125 T6 5,5kW (A7:8) (°)	5,5	49,88	52,10	25.267,62	301,94	4,48	974	1,00
HM 125 T6 7,5kW (A7:4) (°)	7,5	43,42	44,05	47.114,88	257,74	8,02	972	1,00
HM 125 T6 7,5kW (A7:4) (°)	7,5	46,27	47,21	44.722,16	259,70	7,14	976	1,00
HM 125 T6 7,5kW (A7:4) (°)	7,5	48,53	49,81	42.093,44	256,76	6,31	979	1,00
HM 125 T6 7,5kW (A7:8) (°)	7,5	52,42	53,33	36.294,27	356,30	7,25	975	1,00
HM 125 T6 7,5kW (A7:8) (°)	7,5	51,77	53,08	32.420,23	339,13	6,24	979	1,00
HM 125 T6 11kW (A7:8) (°)	11	49,85	49,81	50.429,59	397,94	11,71	971	1,00
HM 125 T6 11kW (A7:8) (°)	11	51,12	51,17	47.063,91	390,88	10,49	974	1,00
HM 125 T6 11kW (A7:8) (°)	11	52,38	52,60	43.692,63	381,99	9,33	977	1,00
HM 125 T6 11kW (A7:8) (°)	11	53,60	54,14	40.297,84	373,57	8,25	979	1,00
HM 125 T6 15kW (A7:8) (°)	15	44,08	43,80	59.793,88	406,49	15,96	971	1,00
HM 125 T6 15kW (A7:8) (°)	15	46,53	46,32	56.998,53	409,20	14,59	973	1,00

Model	Motor power (kW)	Maximum efficiency point data						
		Max. efficiency (%)	Efficiency grade (N) (N)	Air Flow (m3/h)	Ps (Pa)	Pabs (kW)	speed (rpm)	Specific ratio
HM 125 T6 15kW (A7:8) (°)	15	48,79	48,68	53.758,73	403,42	12,94	976	1,00

**ERP / 2/4 poles**

Model	Motor power (kW)	Maximum efficiency point data						
		Max. efficiency (%)	Efficiency grade (N) (N)	Air Flow (m3/h)	Ps (Pa)	Pabs (kW)	speed (rpm)	Specific ratio
HM 45 T2/T4 0,75/0,18kW (A9:4) (°)	0,75	46,91	53,71	4.310,28	314,71	0,84	3000	1,00
HM 45 T2/T4 1,1/0,25kW (A9:4) (°)	1,10	46,55	52,60	5.271,63	334,75	1,11	3000	1,00
HM 45 T2/T4 1,1/0,25kW (A9:8) (°)	1,10	45,64	51,05	4.741,96	448,81	1,40	3000	1,00
HM 45 T2/T4 1,5/0,37kW (A9:4) (°)	1,50	44,47	49,64	6.423,27	373,28	1,53	3000	1,00
HM 45 T2/T4 1,5/0,37kW (A9:8) (°)	1,50	44,83	49,51	5.696,27	484,22	1,82	3000	1,00
HM 45 T2/T4 2,2/0,55kW (A9:4) (°)	2,20	37,57	41,62	8.101,09	380,74	2,29	3000	1,00
HM 45 T2/T4 2,2/0,55kW (A9:4) (°)	2,20	42,56	47,27	7.132,50	384,77	1,81	3000	1,00
HM 45 T2/T4 2,2/0,55kW (A9:8) (°)	2,20	44,42	48,35	7.127,39	506,76	2,41	3000	1,00
HM 45 T2/T4 3/0,75kW (A9:8) (°)	3	42,46	45,85	8.112,16	531,66	2,93	3000	1,00
HM 50 T2/T4 1,1/0,25kW (A9:4) (°)	1,10	49,28	55,39	5.399,21	337,76	1,08	3000	1,00
HM 50 T2/T4 1,5/0,37kW (A9:8) (°)	1,50	46,98	51,64	5.853,32	498,71	1,84	3000	1,00
HM 50 T2/T4 1,5/0,37kW (A9:4) (°)	1,50	48,40	53,68	6.597,18	373,48	1,47	3000	1,00
HM 50 T2/T4 2,2/0,55kW (A9:4) (°)	2,20	44,86	48,68	9.379,68	425,34	2,49	3000	1,00
HM 50 T2/T4 2,2/0,55kW (A9:4) (°)	2,20	47,95	52,27	8.344,74	419,77	2,08	3000	1,00
HM 50 T2/T4 2,2/0,55kW (A9:8) (°)	2,20	49,54	53,41	7.457,24	551,07	2,46	3000	1,00
HM 50 T2/T4 3/0,75kW (A9:4) (°)	3	39,74	42,92	10.656,33	421,76	3,16	3000	1,00
HM 50 T2/T4 3/0,75kW (A9:8) (°)	3	48	50,96	9.263,73	609,11	3,42	3000	1,00
HM 50 T2/T4 4,5/0,9kW (A9:8) (°)	4,50	46,56	49,03	10.516,37	625,59	4,09	3000	1,00
HM 56 T2/T4 1,5/0,37kW (A9:4) (°)	1,50	51,43	57	6.429,24	368,92	1,32	3000	1,00
HM 56 T2/T4 2,2/0,55kW (A9:4) (°)	2,20	51,40	56,03	8.070,68	410,58	1,86	3000	1,00
HM 56 T2/T4 2,2/0,55kW (A9:8) (°)	2,20	52,06	56,12	7.296,29	553,72	2,29	3000	1,00
HM 56 T2/T4 3/0,75kW (A9:4) (°)	3	46,81	49,88	11.755,85	465,47	3,28	3000	1,00
HM 56 T2/T4 3/0,75kW (A9:4) (°)	3	49,57	53,22	10.361,31	445,42	2,67	3000	1,00
HM 56 T2/T4 3/0,75kW (A9:8) (°)	3	51,25	54,41	9.187,18	604,66	3,18	3000	1,00
HM 56 T2/T4 4,5/0,9kW (A9:4) (°)	4,50	41,46	43,77	13.782,89	466,05	4,34	3000	1,00
HM 56 T2/T4 4,5/0,9kW (A9:8) (°)	4,50	50,29	52,50	11.605,40	670,27	4,51	3000	1,00
HM 56 T2/T4 5,5/1,5kW (A9:5) (°)	5,50	42,11	43,66	14.789,96	587,21	5,72	2940	1,00
HM 56 T2/T4 5,5/1,5kW (A9:5) (°)	5,50	47,80	50,04	12.876,14	588,60	4,44	2940	1,00
HM 56 T2/T4 5,5/1,5kW (A9:10) (°)	5,50	49,94	51,41	12.529,46	799,24	5,89	2940	1,00
HM 56 T2/T4 8/1,85kW (A9:10) (°)	8	47,83	48,66	14.567,84	833,05	7,45	2940	1,00



Model	Motor power (kW)	Maximum efficiency point data						
		Max. efficiency (%)	Efficiency grade (N) (N)	Air Flow (m3/h)	Ps (Pa)	Pabs (kW)	speed (rpm)	Specific ratio
HM 63 T2/T4 1,5/0,37kW (A9:4) (°)	1,50	47,91	52,92	7.321,41	375,79	1,62	3000	1,00
HM 63 T2/T4 2,2/0,55kW (A9:4) (°)	2,20	51,22	55,26	9.498,60	434,57	2,31	3000	1,00
HM 63 T2/T4 3/0,75kW (A9:4) (°)	3	48,70	51,59	12.584,08	477,43	3,51	3000	1,00
HM 63 T2/T4 3/0,75kW (A9:8) (°)	3	51,47	55,01	8.584,66	567,57	2,77	3000	1,00
HM 63 T2/T4 4,5/0,9kW (A9:4) (°)	4,50	46,55	48,85	14.564,11	492,10	4,36	3000	1,00
HM 63 T2/T4 4,5/0,9kW (A9:8) (°)	4,50	52,92	55,40	11.067,19	668,78	4,07	3000	1,00
HM 63 T2/T4 5,5/1,5kW (A9:10) (°)	5,50	53,13	54,68	12.572,59	821,40	5,72	2940	1,00
HM 63 T2/T4 8/1,85kW (A9:5) (°)	8	48,14	49,53	16.503,71	625,28	6,06	2940	1,00
HM 63 T2/T4 8/1,85kW (A9:10) (°)	8	50,74	51,40	15.692,48	878,86	7,92	2940	1,00
HM 63 T2/T4 11/2,8kW (A9:5) (°)	11	43,70	44,37	19.744,22	614,46	7,89	2940	1,00
HM 63 T2/T4 11/3kW (A9:10) (°)	11	50,28	50,36	18.771,12	918,15	10,05	2940	1,00
HM 63 T2/T4 15/4kW (A9:10) (°)	15	46,56	46,45	22.158,81	937,37	12,94	2940	1,00

**ERP / 4/6 poles**

Model	Motor power (kW)	Maximum efficiency point data						
		Max. efficiency (%)	Efficiency grade (N) (N)	Air Flow (m3/h)	Ps (Pa)	Pabs (kW)	speed (rpm)	Specific ratio
HM 45 T4/T6 0,55/0,18kW (A0:6) (°)	0,55	32,81	41,31	4.467,33	117,89	0,45	1410	1,00
HM 50 T4/T6 0,55/0,18kW (A0:6) (°)	0,55	34,91	42,59	5.600,18	134,36	0,61	1410	1,00
HM 56 T4/T6 0,37/0,13kW (A5:6) (°)	0,37	39,16	47,30	4.450,98	158,25	0,52	1380	1,00
HM 56 T4/T6 0,55/0,18kW (A2:6) (°)	0,55	38,90	46,29	5.079,11	177,41	0,68	1410	1,00
HM 56 T4/T6 0,55/0,18kW (A2:6) (°)	0,55	38,89	47,20	4.044,51	159,60	0,48	1410	1,00
HM 56 T4/T6 0,55/0,18kW (A2:9) (°)	0,55	37,73	45,06	4.058,71	213,78	0,69	1410	1,00
HM 56 T4/T6 0,55/0,18kW (A5:6) (°)	0,55	40,67	48,26	5.579,79	156,10	0,63	1410	1,00
HM 56 T4/T6 0,75/0,25kW (A2:6) (°)	0,75	41,28	47,96	6.535,55	193,03	0,88	1420	1,00
HM 56 T4/T6 0,75/0,25kW (A2:6) (°)	0,75	43,09	50,15	6.025,67	189,79	0,77	1420	1,00
HM 56 T4/T6 0,75/0,25kW (A2:6) (°)	0,75	43,99	51,28	5.734,45	186,22	0,71	1420	1,00
HM 56 T4/T6 0,75/0,25kW (A2:9) (°)	0,75	44,82	51,79	5.157,47	228,92	0,79	1420	1,00
HM 56 T4/T6 0,75/0,25kW (A5:6) (°)	0,75	42,61	49,73	6.724,10	158,14	0,75	1420	1,00
HM 56 T4/T6 0,75/0,25kW (A5:6) (°)	0,75	40,86	47,66	7.150,49	165,55	0,84	1420	1,00
HM 56 T4/T6 1,1/0,37kW (A2:9) (°)	1,1	42,11	47,86	7.380,42	245	1,24	1430	1,00
HM 56 T4/T6 1,1/0,37kW (A2:9) (°)	1,1	43,48	49,50	6.869,63	242,32	1,12	1430	1,00
HM 56 T4/T6 1,1/0,37kW (A2:9) (°)	1,1	44,95	51,27	6.352,21	239,91	1	1430	1,00
HM 56 T4/T6 1,1/0,37kW (A2:9) (°)	1,1	45,64	52,18	5.992,84	236,38	0,92	1430	1,00
HM 56 T4/T6 1,1/0,37kW (A5:6) (°)	1,1	39,49	46,01	7.592,48	167,07	0,93	1430	1,00
HM 56 T4/T6 1,1/0,37kW (A5:6) (°)	1,1	38,19	44,24	8.313,94	173,66	1,11	1430	1,00





Model	Motor power (kW)	Maximum efficiency point data						
		Max. efficiency (%)	Efficiency grade (N) (N)	Air Flow (m3/h)	Ps (Pa)	Pabs (kW)	speed (rpm)	Specific ratio
HM 56 T4/T6 1,5/0,5kW (A5:6) (°)	1,5	37,56	43,20	9.053,32	177,82	1,28	1430	1,00
HM 63 T4/T6 0,55/0,18kW (A2:6) (°)	0,55	40,93	48,54	5.260,91	166,30	0,63	1410	1,00
HM 63 T4/T6 0,75/0,25kW (A2:6) (°)	0,75	47,89	54,87	6.888,27	187,16	0,79	1420	1,00
HM 63 T4/T6 0,75/0,25kW (A2:9) (°)	0,75	47,89	54,70	5.526,55	241,34	0,84	1420	1,00
HM 63 T4/T6 0,75/0,25kW (A5:6) (°)	0,75	48,90	55,52	7.749,60	190,49	0,90	1420	1,00
HM 63 T4/T6 1,1/0,37kW (A2:6) (°)	1,1	46,88	52,72	9.219,91	212,37	1,20	1430	1,00
HM 63 T4/T6 1,1/0,37kW (A2:6) (°)	1,1	48,85	55,10	8.449,86	206,50	1,03	1430	1,00
HM 63 T4/T6 1,1/0,37kW (A2:6) (°)	1,1	49,29	55,79	7.966,26	201,05	0,94	1430	1,00
HM 63 T4/T6 1,1/0,37kW (A2:9) (°)	1,1	50,67	56,74	7.174,29	258,99	1,10	1430	1,00
HM 63 T4/T6 1,1/0,37kW (A5:6) (°)	1,1	48,36	54,02	9.471,59	223,11	1,28	1430	1,00
HM 63 T4/T6 1,5/0,5kW (A2:6) (°)	1,5	41,51	46,36	11.480,66	221,80	1,72	1430	1,00
HM 63 T4/T6 1,5/0,5kW (A2:6) (°)	1,5	43,42	48,58	10.729,36	219,84	1,53	1430	1,00
HM 63 T4/T6 1,5/0,5kW (A2:6) (°)	1,5	45,36	50,84	9.987,52	218,17	1,37	1430	1,00
HM 63 T4/T6 1,5/0,5kW (A2:9) (°)	1,5	47,16	51,95	9.819,66	285,37	1,75	1430	1,00
HM 63 T4/T6 1,5/0,5kW (A2:9) (°)	1,5	49,14	54,34	8.876,93	280,13	1,51	1430	1,00
HM 63 T4/T6 1,5/0,5kW (A2:9) (°)	1,5	49,93	55,39	8.384,96	273,56	1,37	1430	1,00
HM 63 T4/T6 1,5/0,5kW (A5:6) (°)	1,5	46,28	51,63	10.049,43	224,61	1,43	1430	1,00
HM 63 T4/T6 1,5/0,5kW (A5:6) (°)	1,5	44,66	49,73	10.634,82	229,88	1,58	1430	1,00
HM 63 T4/T6 2,2/0,6kW (A2:6) (°)	2,2	40,27	44,89	12.588,71	211,11	1,87	1430	1,00
HM 63 T4/T6 2,2/0,6kW (A2:9) (°)	2,2	42,28	46,13	12.682,54	289,33	2,47	1430	1,00
HM 63 T4/T6 2,2/0,6kW (A2:9) (°)	2,2	42,79	46,74	12.282,15	291,76	2,38	1430	1,00
HM 63 T4/T6 2,2/0,6kW (A2:9) (°)	2,2	44,34	48,55	11.486,98	291,40	2,17	1430	1,00
HM 63 T4/T6 2,2/0,6kW (A2:9) (°)	2,2	45,66	50,13	10.690,55	291,58	1,97	1430	1,00
HM 63 T4/T6 2,2/0,6kW (A5:6) (°)	2,2	40,29	44,68	12.192,25	230,28	2,03	1430	1,00
HM 63 T4/T6 2,2/0,6kW (A5:6) (°)	2,2	42,15	46,86	11.401	228,88	1,81	1430	1,00
HM 63 T4/T6 3/0,9kW (A2:9) (°)	3	40,70	44,29	13.704,56	281,82	2,71	1440	1,00
HM 71 T4/T6 0,75/0,25kW (A2:6) (°)	0,75	50,66	57,75	6.869,32	190,84	0,76	1420	1,00
HM 71 T4/T6 0,75/0,25kW (A5:6) (°)	0,75	49,90	56,29	8.372,10	200,34	0,98	1420	1,00
HM 71 T4/T6 1,1/0,37kW (A2:6) (°)	1,1	52,73	58,78	9.220,18	216,65	1,11	1430	1,00
HM 71 T4/T6 1,1/0,37kW (A2:9) (°)	1,1	52,93	59,06	7.068,49	271,48	1,07	1430	1,00
HM 71 T4/T6 1,1/0,37kW (A5:6) (°)	1,1	48,19	53,62	10.397,53	221,33	1,39	1430	1,00
HM 71 T4/T6 1,5/0,5kW (A2:6) (°)	1,5	49,42	54,12	12.767,22	242,94	1,82	1430	1,00
HM 71 T4/T6 1,5/0,5kW (A2:6) (°)	1,5	51	56,11	11.661,78	234,90	1,56	1430	1,00
HM 71 T4/T6 1,5/0,5kW (A2:6) (°)	1,5	52,09	57,50	10.912,22	229,75	1,40	1430	1,00
HM 71 T4/T6 1,5/0,5kW (A2:9) (°)	1,5	54,01	59,15	9.622,26	286,74	1,54	1430	1,00
HM 71 T4/T6 1,5/0,5kW (A5:6) (°)	1,5	48,69	53,41	12.484,67	240,66	1,80	1430	1,00
HM 71 T4/T6 2,2/0,6kW (A2:6) (°)	2,2	44,69	48,50	15.873,28	248,35	2,51	1430	1,00
HM 71 T4/T6 2,2/0,6kW (A2:6) (°)	2,2	46,76	50,85	14.856,44	249,66	2,26	1430	1,00

Model	Motor power (kW)	Maximum efficiency point data						
		Max. efficiency (%)	Efficiency grade (N) (N)	Air Flow (m3/h)	Ps (Pa)	Pabs (kW)	speed (rpm)	Specific ratio
HM 71 T4/T6 2,2/0,6kW (A2:6) (°)	2,2	48,42	52,77	13.900,24	250,94	2,06	1430	1,00
HM 71 T4/T6 2,2/0,6kW (A2:9) (°)	2,2	50,87	54,79	13.241,46	315,36	2,41	1430	1,00
HM 71 T4/T6 2,2/0,6kW (A2:9) (°)	2,2	52,47	56,76	12.076,33	309,57	2,10	1430	1,00
HM 71 T4/T6 2,2/0,6kW (A2:9) (°)	2,2	53,24	57,78	11.364,26	301,56	1,92	1430	1,00
HM 71 T4/T6 2,2/0,6kW (A5:6) (°)	2,2	44,44	48,31	14.711,90	256,35	2,46	1430	1,00
HM 71 T4/T6 2,2/0,6kW (A5:6) (°)	2,2	46,08	50,34	13.584,40	248,47	2,13	1430	1,00
HM 71 T4/T6 3/0,9kW (A2:6) (°)	3	40,79	44,17	17.525,73	237,19	2,93	1440	1,00
HM 71 T4/T6 3/0,9kW (A2:9) (°)	3	47,86	51,12	15.671,19	322,48	3,07	1440	1,00
HM 71 T4/T6 3/0,9kW (A2:9) (°)	3	49,76	53,34	14.476,09	320,58	2,73	1440	1,00
HM 71 T4/T6 3/0,9kW (A5:6) (°)	3	41,28	44,71	16.071,79	257,98	2,89	1440	1,00
HM 71 T4/T6 3/0,9kW (A5:6) (°)	3	42,73	46,36	15.385,79	256,45	2,67	1440	1,00
HM 80 T4/T6 1,1/0,37kW (A2:6) (°)	1,1	54,76	61,15	8.717,96	212,26	0,98	1430	1,00
HM 80 T4/T6 1,5/0,5kW (A2:6) (°)	1,5	55,12	60,30	12.084,38	236,27	1,52	1430	1,00
HM 80 T4/T6 1,5/0,5kW (A2:9) (°)	1,5	54,96	60,20	9.312,63	298,57	1,49	1430	1,00
HM 80 T4/T6 2,2/0,6kW (A2:6) (°)	2,2	52,93	56,72	16.968,83	270,13	2,53	1430	1,00
HM 80 T4/T6 2,2/0,6kW (A2:6) (°)	2,2	54,26	58,46	15.422,24	262,37	2,18	1430	1,00
HM 80 T4/T6 2,2/0,6kW (A2:6) (°)	2,2	55,24	59,75	14.418,13	254,06	1,94	1430	1,00
HM 80 T4/T6 2,2/0,6kW (A2:9) (°)	2,2	55,64	59,77	12.722,75	323,27	2,24	1430	1,00
HM 80 T4/T6 3/0,9kW (A2:6) (°)	3	49,42	52,48	20.023,66	281,83	3,30	1440	1,00
HM 80 T4/T6 3/0,9kW (A2:6) (°)	3	52,33	55,77	18.524,04	278,91	2,88	1440	1,00
HM 80 T4/T6 3/0,9kW (A2:9) (°)	3	54,50	57,80	16.131,69	341,20	3,03	1440	1,00
HM 80 T4/T6 3/0,9kW (A2:9) (°)	3	55	58,54	15.084,16	335,23	2,77	1440	1,00
HM 80 T4/T6 3/0,9kW (A5:6) (°)	3	55,68	59,36	17.060,33	297,05	2,63	1440	1,00
HM 80 T4/T6 3/0,9kW (A5:6) (°)	3	52,36	55,66	18.296,01	296,87	3,02	1440	1,00
HM 80 T4/T6 3/0,9kW (A5:6) (°)	3	49,80	52,77	19.560,26	299,70	3,41	1440	1,00
HM 80 T4/T6 4/1,1kW (A2:6) (°)	4	44,72	47,25	22.250,17	282,99	4	1430	1,00
HM 80 T4/T6 4/1,1kW (A2:6) (°)	4	46,89	49,62	21.482,19	284,61	3,72	1430	1,00
HM 80 T4/T6 4/1,1kW (A2:9) (°)	4	48,42	50,73	19.784,99	357,65	4,32	1430	1,00
HM 80 T4/T6 4/1,1kW (A2:9) (°)	4	51,81	54,64	17.915,03	349,60	3,60	1430	1,00
HM 80 T4/T6 4/1,1kW (A5:6) (°)	4	47,80	50,18	22.715,02	308,46	4,22	1430	1,00
HM 80 T4/T6 4/1,1kW (A5:6) (°)	4	48,62	51,28	21.096,99	306,23	3,82	1430	1,00
HM 80 T4/T6 5,5/1,85kW (A2:6) (°)	5,5	40,21	42,30	24.071,60	277,60	4,69	1450	1,00
HM 80 T4/T6 5,5/1,85kW (A2:9) (°)	5,5	44,93	46,54	23.818,35	368,51	5,61	1450	1,00
HM 80 T4/T6 5,5/1,85kW (A2:9) (°)	5,5	46,29	48,05	22.877,51	371,99	5,31	1450	1,00
HM 80 T4/T6 5,5/1,85kW (A2:9) (°)	5,5	47,48	49,53	21.293,55	364,53	4,77	1450	1,00
HM 90 T4/T6 3/0,9kW (A6:3) (°)	3	49,14	52,47	18.593,33	272,71	2,99	1440	1,00
HM 90 T4/T6 3/0,9kW (A6:3) (°)	3	49,24	53,01	17.038,58	253,36	2,54	1440	1,00
HM 90 T4/T6 4/1,1kW (A6:3) (°)	4	46,32	48,52	23.127,77	320,19	4,51	1430	1,00



Model	Motor power (kW)	Maximum efficiency point data						
		Max. efficiency (%)	Efficiency grade (N) (N)	Air Flow (m3/h)	Ps (Pa)	Pabs (kW)	speed (rpm)	Specific ratio
HM 90 T4/T6 4/1,1kW (A6:3) (°)	4	47,64	50,20	21.621,45	305,39	3,95	1430	1,00
HM 90 T4/T6 4/1,1kW (A6:3) (°)	4	49,02	51,96	20.176,85	290,07	3,44	1430	1,00
HM 90 T4/T6 5,5/1,85kW (A6:3) (°)	5,5	42,51	44,07	25.979,43	325,52	5,70	1450	1,00
HM 90 T4/T6 5,5/1,85kW (A6:3) (°)	5,5	44,67	46,56	24.523,24	324,85	5,05	1450	1,00
HM 90 T4/T6 5,5/1,85kW (A6:6) (°)	5,5	52,09	53,95	20.849,42	427,50	5,10	1450	1,00
HM 90 T4/T6 5,5/1,85kW (A6:6) (°)	5,5	52,33	54,63	18.994,33	402,25	4,36	1450	1,00
HM 90 T4/T6 7,5/2,2kW (A6:3) (°)	7,5	37,69	38,61	28.887,19	325,88	7,19	1450	1,00
HM 90 T4/T6 7,5/2,2kW (A6:3) (°)	7,5	40,44	41,70	27.421,18	326,25	6,36	1450	1,00
HM 90 T4/T6 7,5/2,2kW (A6:6) (°)	7,5	49,11	49,82	25.483,88	502,92	7,77	1450	1,00
HM 90 T4/T6 7,5/2,2kW (A6:6) (°)	7,5	50,47	51,56	24.007,62	478,74	6,76	1450	1,00
HM 90 T4/T6 7,5/2,2kW (A6:6) (°)	7,5	52,03	53,52	22.583,12	453,19	5,86	1450	1,00
HM 90 T4/T6 11/3,6kW (A6:3) (°)	11	35,39	36	30.411,02	323,70	8,06	1430	1,00
HM 90 T4/T6 11/3,6kW (A6:6) (°)	11	44,02	44,05	30.278,42	536,63	10,78	1430	1,00
HM 90 T4/T6 11/3,6kW (A6:6) (°)	11	45,83	45,93	28.603,97	528,78	9,71	1430	1,00
HM 90 T4/T6 11/3,6kW (A6:6) (°)	11	47,73	48,14	27.036,29	517,97	8,68	1430	1,00
HM 90 T4/T6 15/4,4kW (A6:6) (°)	15	38,70	38,52	35.693,49	524,48	13,93	1420	1,00
HM 90 T4/T6 15/4,4kW (A6:6) (°)	15	40,84	40,73	34.393,14	529,97	12,77	1420	1,00
HM 90 T4/T6 15/4,4kW (A6:6) (°)	15	42,56	42,53	32.348,89	530,89	11,68	1420	1,00
HM 100 T4/T6 5,5/1,85kW (A6:3) (°)	5,5	51,93	53,44	29.182,08	364,29	5,80	1450	1,00
HM 100 T4/T6 5,5/1,85kW (A6:3) (°)	5,5	53,98	55,89	27.115,65	348	5,01	1450	1,00
HM 100 T4/T6 5,5/1,85kW (A6:3) (°)	5,5	54,92	57,78	24.876,14	326,93	3,55	1450	1,00
HM 100 T4/T6 5,5/1,85kW (A6:3) (°)	5,5	55,26	58,08	22.586,33	303,57	3,60	1450	1,00
HM 100 T4/T6 7,5/2,2kW (A6:3) (°)	7,5	48,09	48,91	33.404,84	381,28	7,47	1450	1,00
HM 100 T4/T6 7,5/2,2kW (A6:3) (°)	7,5	50,50	51,66	31.271,98	379,40	6,61	1450	1,00
HM 100 T4/T6 7,5/2,2kW (A6:6) (°)	7,5	55,67	56,47	27.135,33	513,68	7,53	1450	1,00
HM 100 T4/T6 7,5/2,2kW (A6:6) (°)	7,5	55,71	56,99	24.343,21	481,25	6,33	1450	1,00
HM 100 T4/T6 11/3,6kW (A6:3) (°)	11	40,08	40,13	39.152,83	372,58	10,53	1430	1,00
HM 100 T4/T6 11/3,6kW (A6:3) (°)	11	42,98	43,16	37.709,85	376,65	9,43	1430	1,00
HM 100 T4/T6 11/3,6kW (A6:3) (°)	11	46	46,52	35.700,53	378,41	8,34	1430	1,00
HM 100 T4/T6 11/3,6kW (A6:6) (°)	11	53,63	53,63	35.488,84	574,93	11,11	1430	1,00
HM 100 T4/T6 11/3,6kW (A6:6) (°)	11	55,05	55,13	32.630,11	557,41	9,78	1430	1,00
HM 100 T4/T6 11/3,6kW (A6:6) (°)	11	55,82	56,24	29.855,14	541,52	8,67	1430	1,00
HM 100 T4/T6 15/4,4kW (A6:3) (°)	15	37,57	37,54	40.656,41	369,08	11,69	1420	1,00
HM 100 T4/T6 15/4,4kW (A6:6) (°)	15	50,07	49,90	40.698,13	591,56	13,95	1420	1,00
HM 100 T4/T6 15/4,4kW (A6:6) (°)	15	51,97	51,88	38.100,43	584,23	12,47	1420	1,00
HM 100 T4/T6 18,5/6kW (A6:6) (°)	18,5	45,61	45,26	45.749,12	601,46	17,37	1420	1,00
HM 100 T4/T6 18,5/6kW (A6:6) (°)	18,5	48,12	47,86	43.258,41	598,12	15,55	1420	1,00
HM 100 T4/T6 22/7,5kW (A6:6) (°)	22	41,11	40,62	50.228,34	595,14	20,96	1420	1,00



Model	Motor power (kW)	Maximum efficiency point data						
		Max. efficiency (%)	Efficiency grade (N) (N)	Air Flow (m3/h)	Ps (Pa)	Pabs (kW)	speed (rpm)	Specific ratio
HM 100 T4/T6 22/7,5kW (A6:6) (°)	22	43,50	43,08	48.316,64	603,86	19,22	1420	1,00
HM 112 T4/T6 5,5/1,85kW (A6:3) (°)	5,5	54,25	55,76	30.997,21	358,03	5,82	1450	1,00
HM 112 T4/T6 5,5/1,85kW (A6:3) (°)	5,5	52,66	54,65	27.306,06	330,01	4,88	1450	1,00
HM 112 T4/T6 7,5/2,2kW (A6:3) (°)	7,5	53,05	53,66	38.016,12	397,60	8,05	1450	1,00
HM 112 T4/T6 7,5/2,2kW (A6:3) (°)	7,5	54,90	55,97	34.623,10	381,96	6,82	1450	1,00
HM 112 T4/T6 11/3,6kW (A6:3) (°)	11	49,77	49,81	44.242,32	420,80	10,58	1430	1,00
HM 112 T4/T6 11/3,6kW (A6:3) (°)	11	51,95	52,16	41.611,52	412,38	9,32	1430	1,00
HM 112 T4/T6 11/3,6kW (A6:6) (°)	11	55,93	55,99	34.046,39	574,11	10,34	1430	1,00
HM 112 T4/T6 11/3,6kW (A6:6) (°)	11	54,88	55,27	30.082,65	539,13	8,72	1430	1,00
HM 112 T4/T6 15/4,4kW (A6:3) (°)	15	42,11	41,87	51.227,83	432,64	15,09	1420	1,00
HM 112 T4/T6 15/4,4kW (A6:3) (°)	15	45,05	44,90	49.204,26	432,78	13,44	1420	1,00
HM 112 T4/T6 15/4,4kW (A6:3) (°)	15	47,99	47,94	46.861,26	428,16	11,84	1420	1,00
HM 112 T4/T6 15/4,4kW (A6:6) (°)	15	56,36	56,09	46.246,85	646,55	15,69	1420	1,00
HM 112 T4/T6 15/4,4kW (A6:6) (°)	15	56,60	56,43	42.073,29	625,95	13,77	1420	1,00
HM 112 T4/T6 15/4,4kW (A6:6) (°)	15	56,68	56,62	37.975,26	606,49	12	1420	1,00
HM 112 T4/T6 18,5/6kW (A6:3) (°)	18,5	39,21	38,89	53.213,23	431,91	16,92	1420	1,00
HM 112 T4/T6 18,5/6kW (A6:6) (°)	18,5	55,23	54,87	49.777,71	670,80	17,71	1420	1,00
HM 112 T4/T6 22/7,5kW (A6:6) (°)	22	52,42	51,89	56.927	709,72	22,10	1420	1,00
HM 112 T4/T6 22/7,5kW (A6:6) (°)	22	54,11	53,66	53.425,81	693,47	19,83	1420	1,00
HM 125 T4/T6 11/3,6kW (A7:4) (°)	11	52,76	52,77	41.381,22	490,92	11,07	1430	1,00
HM 125 T4/T6 11/3,6kW (A7:4) (°)	11	50,56	50,75	36.598,97	451,89	9,42	1430	1,00
HM 125 T4/T6 15/4,4kW (A7:4) (°)	15	53,91	53,68	51.353,96	552,14	15,01	1420	1,00
HM 125 T4/T6 15/4,4kW (A7:4) (°)	15	54,08	53,97	46.299,44	524,29	12,87	1420	1,00
HM 125 T4/T6 15/4,4kW (A7:8) (°)	15	52,26	51,99	39.157,13	716,62	15,77	1420	1,00
HM 125 T4/T6 18,5/6kW (A7:4) (°)	18,5	52,29	51,84	60.854,33	594,58	19,69	1420	1,00
HM 125 T4/T6 18,5/6kW (A7:4) (°)	18,5	53,91	53,56	56.643,01	578,72	17,27	1420	1,00
HM 125 T4/T6 18,5/6kW (A7:8) (°)	18,5	53,09	52,68	44.346,10	765,42	18,80	1420	1,00
HM 125 T4/T6 22/7,5kW (A7:4) (°)	22	50,53	49,99	65.025,18	610,99	22,31	1420	1,00
HM 125 T4/T6 22/7,5kW (A7:8) (°)	22	53,73	53,20	49.919,85	809,99	22,10	1420	1,00

**ERP / 4/8 poles**

Model	Motor power (kW)	Maximum efficiency point data						
		Max. efficiency (%)	Efficiency grade (N) (N)	Air Flow (m3/h)	Ps (Pa)	Pabs (kW)	speed (rpm)	Specific ratio
HM 45 T4/T8 0,33/0,04kW (A0:6) (°)	0,33/0,04	27,90	36,87	4.031,59	88,07	0,38	1420	1,00
HM 50 T4/T8 0,55/0,09kW (A0:6) (°)	0,55/0,09	34,91	42,59	5.600,18	134,36	0,61	1420	1,00



Model	Motor power (kW)	Maximum efficiency point data						
		Max. efficiency (%)	Efficiency grade (N) (N)	Air Flow (m3/h)	Ps (Pa)	Pabs (kW)	speed (rpm)	Specific ratio
HM 56 T4/T8 0,33/0,04kW (A5:6) (°)	0,33/0,04	39,16	47,30	4.450,98	158,25	0,52	1420	1,00
HM 56 T4/T8 0,55/0,09kW (A2:6) (°)	0,55/0,09	38,90	46,29	5.079,11	177,41	0,68	1420	1,00
HM 56 T4/T8 0,55/0,09kW (A2:6) (°)	0,55/0,09	38,89	47,20	4.044,51	159,60	0,48	1420	1,00
HM 56 T4/T8 0,55/0,09kW (A2:9) (°)	0,55/0,09	37,73	45,06	4.058,71	213,78	0,69	1420	1,00
HM 56 T4/T8 0,55/0,09kW (A5:6) (°)	0,55/0,09	40,67	48,26	5.579,79	156,10	0,63	1420	1,00
HM 56 T4/T8 0,75/0,12kW (A2:6) (°)	0,75/0,12	43,99	51,28	5.734,45	186,22	0,71	1420	1,00
HM 56 T4/T8 0,75/0,12kW (A2:6) (°)	0,75/0,12	41,28	47,96	6.535,55	193,03	0,88	1420	1,00
HM 56 T4/T8 0,75/0,12kW (A2:6) (°)	0,75/0,12	43,09	50,15	6.025,67	189,79	0,77	1420	1,00
HM 56 T4/T8 0,75/0,12kW (A2:9) (°)	0,75/0,12	44,82	51,79	5.157,47	228,92	0,79	1420	1,00
HM 56 T4/T8 0,75/0,12kW (A5:6) (°)	0,75/0,12	40,86	47,99	7.150,49	147,76	0,75	1420	1,00
HM 56 T4/T8 0,75/0,12kW (A5:6) (°)	0,75/0,12	42,61	49,42	6.724,10	173,51	0,84	1420	1,00
HM 56 T4/T8 1,1/0,18kW (A2:9) (°)	1,1/0,18	45,64	52,18	5.992,84	236,38	0,92	1420	1,00
HM 56 T4/T8 1,1/0,18kW (A2:9) (°)	1,1/0,18	42,11	47,86	7.380,42	245	1,24	1420	1,00
HM 56 T4/T8 1,1/0,18kW (A2:9) (°)	1,1/0,18	43,48	49,50	6.869,63	242,32	1,12	1420	1,00
HM 56 T4/T8 1,1/0,18kW (A2:9) (°)	1,1/0,18	44,95	51,27	6.352,21	239,91	1	1420	1,00
HM 56 T4/T8 1,1/0,18kW (A5:6) (°)	1,1/0,18	38,19	44,24	8.313,94	173,66	1,11	1420	1,00
HM 56 T4/T8 1,1/0,18kW (A5:6) (°)	1,1/0,18	39,49	46,01	7.592,48	167,07	0,93	1420	1,00
HM 56 T4/T8 1,5/0,25kW (A2:9) (°)	1,5/0,25	41,07	46,57	7.899,82	243,19	1,35	1420	1,00
HM 56 T4/T8 1,5/0,25kW (A2:9) (°)	1,5/0,25	39,25	44,49	8.409,63	242,60	1,49	1420	1,00
HM 56 T4/T8 1,5/0,25kW (A5:6) (°)	1,5/0,25	37,56	43,20	9.053,32	177,82	1,28	1420	1,00
HM 63 T4/T8 0,55/0,09kW (A2:6) (°)	0,55/0,09	40,93	48,54	5.260,91	166,30	0,63	1420	1,00
HM 63 T4/T8 0,75/0,12kW (A2:6) (°)	0,75/0,12	47,89	54,87	6.888,27	187,16	0,79	1420	1,00
HM 63 T4/T8 0,75/0,12kW (A2:9) (°)	0,75/0,12	47,89	54,70	5.526,55	241,34	0,84	1420	1,00
HM 63 T4/T8 0,75/0,12kW (A5:6) (°)	0,75/0,12	48,90	55,52	7.749,60	190,49	0,90	1420	1,00
HM 63 T4/T8 1,1/0,18kW (A2:6) (°)	1,1/0,18	49,29	55,79	7.966,26	201,05	0,94	1420	1,00
HM 63 T4/T8 1,1/0,18kW (A2:6) (°)	1,1/0,18	46,88	52,72	9.219,91	212,37	1,20	1420	1,00
HM 63 T4/T8 1,1/0,18kW (A2:6) (°)	1,1/0,18	48,85	55,10	8.449,86	206,50	1,03	1420	1,00
HM 63 T4/T8 1,1/0,18kW (A2:9) (°)	1,1/0,18	49,93	55,39	8.384,96	273,56	1,37	1420	1,00
HM 63 T4/T8 1,1/0,18kW (A2:9) (°)	1,1/0,18	50,67	56,74	7.174,29	258,99	1,10	1420	1,00
HM 63 T4/T8 1,1/0,18kW (A5:6) (°)	1,1/0,18	48,36	54,02	9.471,59	223,11	1,28	1420	1,00
HM 63 T4/T8 1,5/0,25kW (A2:6) (°)	1,5/0,25	45,36	50,84	9.987,52	218,17	1,37	1420	1,00
HM 63 T4/T8 1,5/0,25kW (A2:6) (°)	1,5/0,25	41,51	46,36	11.480,66	221,80	1,72	1420	1,00
HM 63 T4/T8 1,5/0,25kW (A2:6) (°)	1,5/0,25	43,42	48,58	10.729,36	219,84	1,53	1420	1,00
HM 63 T4/T8 1,5/0,25kW (A2:9) (°)	1,5/0,25	47,16	51,95	9.819,66	285,37	1,75	1420	1,00
HM 63 T4/T8 1,5/0,25kW (A2:9) (°)	1,5/0,25	49,14	54,34	8.876,93	280,13	1,51	1420	1,00
HM 63 T4/T8 1,5/0,25kW (A5:6) (°)	1,5/0,25	44,66	49,73	10.634,82	229,88	1,58	1420	1,00
HM 63 T4/T8 1,5/0,25kW (A5:6) (°)	1,5/0,25	46,28	51,63	10.049,43	224,61	1,43	1420	1,00
HM 63 T4/T8 2,2/0,37kW (A2:9) (°)	2,2/0,37	42,28	46,13	12.682,54	289,33	2,47	1420	1,00



Model	Motor power (kW)	Maximum efficiency point data						
		Max. efficiency (%)	Efficiency grade (N) (N)	Air Flow (m3/h)	Ps (Pa)	Pabs (kW)	speed (rpm)	Specific ratio
HM 63 T4/T8 2,2/0,37kW (A2:9) (°)	2,2/0,37	42,79	46,74	12.282,15	291,76	2,38	1420	1,00
HM 63 T4/T8 2,2/0,37kW (A2:9) (°)	2,2/0,37	44,34	48,55	11.486,98	291,40	2,17	1420	1,00
HM 63 T4/T8 2,2/0,37kW (A2:9) (°)	2,2/0,37	45,66	50,13	10.690,55	291,58	1,97	1420	1,00
HM 63 T4/T8 2,2/0,37kW (A5:6) (°)	2,2/0,37	42,15	46,86	11.401	228,88	1,81	1420	1,00
HM 63 T4/T8 2,2/0,37kW (A5:6) (°)	2,2/0,37	40,29	44,68	12.192,25	230,28	2,03	1420	1,00
HM 63 T4/T8 3/0,55kW (A2:9) (°)	3/0,55	40,70	44,29	13.704,56	281,82	2,71	1420	1,00
HM 71 T4/T8 0,75/0,12kW (A2:6) (°)	0,75/0,12	50,66	57,75	6.869,32	190,84	0,76	1420	1,00
HM 71 T4/T8 0,75/0,12kW (A5:6) (°)	0,75/0,12	49,90	56,29	8.372,10	200,34	0,98	1420	1,00
HM 71 T4/T8 1,1/0,18kW (A2:6) (°)	1,1/0,18	52,73	58,78	9.220,18	216,65	1,11	1420	1,00
HM 71 T4/T8 1,1/0,18kW (A2:9) (°)	1,1/0,18	53,69	59,86	7.068,49	271,48	1,06	1420	1,00
HM 71 T4/T8 1,1/0,18kW (A5:6) (°)	1,1/0,18	48,19	53,62	10.397,53	221,33	1,39	1420	1,00
HM 71 T4/T8 1,5/0,25kW (A2:6) (°)	1,5/0,25	52,09	57,50	10.912,22	229,75	1,40	1420	1,00
HM 71 T4/T8 1,5/0,25kW (A2:6) (°)	1,5/0,25	49,42	54,12	12.767,22	242,94	1,82	1420	1,00
HM 71 T4/T8 1,5/0,25kW (A2:6) (°)	1,5/0,25	51	56,11	11.661,78	234,90	1,56	1420	1,00
HM 71 T4/T8 1,5/0,25kW (A2:9) (°)	1,5/0,25	54,01	59,15	9.622,26	286,74	1,54	1420	1,00
HM 71 T4/T8 1,5/0,25kW (A5:6) (°)	1,5/0,25	48,69	53,41	12.484,67	240,66	1,80	1420	1,00
HM 71 T4/T8 2,2/0,37kW (A2:6) (°)	2,2/0,37	44,69	48,50	15.873,28	248,35	2,51	1420	1,00
HM 71 T4/T8 2,2/0,37kW (A2:6) (°)	2,2/0,37	46,76	50,85	14.856,44	249,66	2,26	1420	1,00
HM 71 T4/T8 2,2/0,37kW (A2:6) (°)	2,2/0,37	48,42	52,77	13.900,24	250,94	2,06	1420	1,00
HM 71 T4/T8 2,2/0,37kW (A2:9) (°)	2,2/0,37	50,87	54,79	13.241,46	315,36	2,41	1420	1,00
HM 71 T4/T8 2,2/0,37kW (A2:9) (°)	2,2/0,37	52,47	56,76	12.076,33	309,57	2,10	1420	1,00
HM 71 T4/T8 2,2/0,37kW (A2:9) (°)	2,2/0,37	53,24	57,78	11.364,26	301,56	1,92	1420	1,00
HM 71 T4/T8 2,2/0,37kW (A5:6) (°)	2,2/0,37	44,44	48,31	14.711,90	256,35	2,46	1420	1,00
HM 71 T4/T8 2,2/0,37kW (A5:6) (°)	2,2/0,37	46,08	50,34	13.584,40	248,47	2,13	1420	1,00
HM 71 T4/T8 3/0,55kW (A2:6) (°)	3/0,55	40,79	44,17	17.525,73	237,19	2,93	1420	1,00
HM 71 T4/T8 3/0,55kW (A2:9) (°)	3/0,55	47,86	51,12	15.671,19	322,48	3,07	1420	1,00
HM 71 T4/T8 3/0,55kW (A2:9) (°)	3/0,55	49,76	53,34	14.476,09	320,58	2,73	1420	1,00
HM 71 T4/T8 3/0,55kW (A5:6) (°)	3/0,55	41,28	44,71	16.071,79	257,98	2,89	1420	1,00
HM 71 T4/T8 3/0,55kW (A5:6) (°)	3/0,55	42,73	46,36	15.385,79	256,45	2,67	1420	1,00
HM 80 T4/T8 1,1/0,18kW (A2:6) (°)	1,1/0,18	54,76	61,15	8.717,96	212,26	0,98	1420	1,00
HM 80 T4/T8 1,5/0,25kW (A2:6) (°)	1,5/0,25	55,12	60,30	12.084,38	236,27	1,52	1420	1,00
HM 80 T4/T8 1,5/0,25kW (A2:9) (°)	1,5/0,25	54,96	60,20	9.312,63	298,57	1,49	1420	1,00
HM 80 T4/T8 2,2/0,37kW (A2:6) (°)	2,2/0,37	52,93	56,72	16.968,83	270,13	2,53	1420	1,00
HM 80 T4/T8 2,2/0,37kW (A2:6) (°)	2,2/0,37	54,26	58,46	15.422,24	262,37	2,18	1420	1,00
HM 80 T4/T8 2,2/0,37kW (A2:6) (°)	2,2/0,37	55,24	59,75	14.418,13	254,06	1,94	1420	1,00
HM 80 T4/T8 2,2/0,37kW (A2:9) (°)	2,2/0,37	55,64	59,77	12.722,75	323,27	2,24	1420	1,00
HM 80 T4/T8 3/0,55kW (A2:6) (°)	3/0,55	52,33	55,77	18.524,04	278,91	2,88	1420	1,00
HM 80 T4/T8 3/0,55kW (A2:6) (°)	3/0,55	49,42	52,48	20.023,66	281,83	3,30	1420	1,00



Model	Motor power (kW)	Maximum efficiency point data						
		Max. efficiency (%)	Efficiency grade (N) (N)	Air Flow (m3/h)	Ps (Pa)	Pabs (kW)	speed (rpm)	Specific ratio
HM 80 T4/T8 3/0,55kW (A2:9) (°)	3/0,55	54,50	57,80	16.131,69	341,20	3,03	1420	1,00
HM 80 T4/T8 3/0,55kW (A2:9) (°)	3/0,55	55	58,54	15.084,16	335,23	2,77	1420	1,00
HM 80 T4/T8 3/0,55kW (A5:6) (°)	3/0,55	49,80	52,77	19.560,26	299,70	3,41	1420	1,00
HM 80 T4/T8 3/0,55kW (A5:6) (°)	3/0,55	52,36	55,66	18.296,01	296,87	3,02	1420	1,00
HM 80 T4/T8 3/0,55kW (A5:6) (°)	3/0,55	55,68	59,36	17.060,33	297,05	2,63	1420	1,00
HM 80 T4/T8 4/0,75kW (A2:6) (°)	4/0,75	44,72	47,25	22.250,17	282,99	4	1420	1,00
HM 80 T4/T8 4/0,75kW (A2:6) (°)	4/0,75	46,89	49,62	21.482,19	284,61	3,72	1420	1,00
HM 80 T4/T8 4/0,75kW (A2:9) (°)	4/0,75	51,81	54,64	17.915,03	349,60	3,60	1420	1,00
HM 80 T4/T8 4/0,75kW (A5:6) (°)	4/0,75	48,62	51,28	21.096,99	306,23	3,82	1420	1,00
HM 80 T4/T8 4/0,75kW (A5:6) (°)	4/0,75	47,80	50,18	22.715,02	308,46	4,22	1420	1,00
HM 80 T4/T8 5,5/1,1kW (A2:6) (°)	5,5/1,1	40,21	42,30	24.071,60	277,60	4,69	1420	1,00
HM 80 T4/T8 5,5/1,1kW (A2:9) (°)	5,5/1,1	46,29	48,05	22.877,51	371,99	5,31	1420	1,00
HM 80 T4/T8 5,5/1,1kW (A2:9) (°)	5,5/1,1	47,48	49,53	21.293,55	364,53	4,77	1420	1,00
HM 80 T4/T8 5,5/1,1kW (A2:9) (°)	5,5/1,1	48,42	50,73	19.784,99	357,65	4,32	1420	1,00
HM 90 T4/T8 3/0,55kW (A6:3) (°)	3/0,55	49,14	52,47	18.593,33	272,71	2,99	1420	1,00
HM 90 T4/T8 3/0,55kW (A6:3) (°)	3/0,55	49,24	53,01	17.038,58	253,36	2,54	1420	1,00
HM 90 T4/T8 4/0,75kW (A6:3) (°)	4/0,75	47,64	50,20	21.621,45	305,39	3,95	1420	1,00
HM 90 T4/T8 4/0,75kW (A6:3) (°)	4/0,75	49,02	51,96	20.176,85	290,07	3,44	1420	1,00
HM 90 T4/T8 4/0,75kW (A6:3) (°)	4/0,75	46,32	48,52	23.127,77	320,19	4,51	1420	1,00
HM 90 T4/T8 5,5/1,1kW (A6:3) (°)	5,5/1,1	44,67	46,56	24.523,24	324,85	5,05	1420	1,00
HM 90 T4/T8 5,5/1,1kW (A6:3) (°)	5,5/1,1	42,51	44,07	25.979,43	325,52	5,70	1420	1,00
HM 90 T4/T8 5,5/1,1kW (A6:6) (°)	5,5/1,1	52,09	53,95	20.849,42	427,50	5,10	1420	1,00
HM 90 T4/T8 5,5/1,1kW (A6:6) (°)	5,5/1,1	52,33	54,63	18.994,33	402,25	4,36	1420	1,00
HM 90 T4/T8 7,5/1,5kW (A6:3) (°)	7,5/1,5	37,69	38,61	28.887,19	325,88	7,19	1420	1,00
HM 90 T4/T8 7,5/1,5kW (A6:3) (°)	7,5/1,5	40,44	41,70	27.421,18	326,25	6,36	1420	1,00
HM 90 T4/T8 7,5/1,5kW (A6:6) (°)	7,5/1,5	49,11	49,82	25.483,88	502,92	7,77	1420	1,00
HM 90 T4/T8 7,5/1,5kW (A6:6) (°)	7,5/1,5	50,47	51,56	24.007,62	478,74	6,76	1420	1,00
HM 90 T4/T8 7,5/1,5kW (A6:6) (°)	7,5/1,5	52,03	53,52	22.583,12	453,19	5,86	1420	1,00
HM 90 T4/T8 11/3kW (A6:6) (°)	11/3	44,02	44,05	30.278,42	536,63	10,78	1420	1,00
HM 90 T4/T8 11/3kW (A6:6) (°)	11/3	45,83	45,93	28.603,97	528,78	9,71	1420	1,00
HM 90 T4/T8 11/3kW (A6:6) (°)	11/3	47,73	48,14	27.036,29	517,97	8,68	1420	1,00
HM 90 T4/T8 15/3,5kW (A6:6) (°)	15/3,5	38,70	38,52	35.693,49	524,48	13,93	1420	1,00
HM 90 T4/T8 15/3,5kW (A6:6) (°)	15/3,5	40,84	40,73	34.393,14	529,97	12,77	1420	1,00
HM 90 T4/T8 15/3,5kW (A6:6) (°)	15/3,5	42,56	42,53	32.348,89	530,89	11,68	1420	1,00
HM 100 T4/T8 5,5/1,1kW (A6:3) (°)	5,5/1,1	53,98	55,89	27.115,65	348	5,01	1420	1,00
HM 100 T4/T8 5,5/1,1kW (A6:3) (°)	5,5/1,1	51,93	53,44	29.182,08	364,29	5,80	1420	1,00
HM 100 T4/T8 5,5/1,1kW (A6:3) (°)	5,5/1,1	55,26	58,08	22.586,33	303,57	3,60	1420	1,00
HM 100 T4/T8 5,5/1,1kW (A6:3) (°)	5,5/1,1	54,92	57,78	24.876,14	326,93	3,55	1420	1,00





Model	Motor power (kW)	Maximum efficiency point data						
		Max. efficiency (%)	Efficiency grade (N) (N)	Air Flow (m3/h)	Ps (Pa)	Pabs (kW)	speed (rpm)	Specific ratio
HM 100 T4/T8 7,5/1,5kW (A6:3) (°)	7,5/1,5	48,09	48,91	33.404,84	381,28	7,47	1420	1,00
HM 100 T4/T8 7,5/1,5kW (A6:3) (°)	7,5/1,5	50,50	51,66	31.271,98	379,40	6,61	1420	1,00
HM 100 T4/T8 7,5/1,5kW (A6:6) (°)	7,5/1,5	55,67	56,47	27.135,33	513,68	7,53	1420	1,00
HM 100 T4/T8 7,5/1,5kW (A6:6) (°)	7,5/1,5	55,71	56,99	24.343,21	481,25	6,33	1420	1,00
HM 100 T4/T8 11/3kW (A6:3) (°)	11/3	40,08	40,13	39.152,83	372,58	10,53	1420	1,00
HM 100 T4/T8 11/3kW (A6:3) (°)	11/3	42,98	43,16	37.709,85	376,65	9,43	1420	1,00
HM 100 T4/T8 11/3kW (A6:3) (°)	11/3	46	46,52	35.700,53	378,41	8,34	1420	1,00
HM 100 T4/T8 11/3kW (A6:6) (°)	11/3	53,63	53,63	35.488,84	574,93	11,11	1420	1,00
HM 100 T4/T8 11/3kW (A6:6) (°)	11/3	55,05	55,13	32.630,11	557,41	9,78	1420	1,00
HM 100 T4/T8 11/3kW (A6:6) (°)	11/3	55,82	56,24	29.855,14	541,52	8,67	1420	1,00
HM 100 T4/T8 15/3,5kW (A6:6) (°)	15/3,5	50,07	49,90	40.698,13	591,56	13,95	1420	1,00
HM 100 T4/T8 15/3,5kW (A6:6) (°)	15/3,5	51,97	51,88	38.100,43	584,23	12,47	1420	1,00
HM 100 T4/T8 17/4,3kW (A6:6) (°)	17/4,3	45,61	45,26	45.749,12	601,46	17,37	1420	1,00
HM 100 T4/T8 17/4,3kW (A6:6) (°)	17/4,3	48,12	47,86	43.258,41	598,12	15,55	1420	1,00
HM 100 T4/T8 20/5kW (A6:6) (°)	20/5	43,50	43,08	48.316,64	603,86	19,22	1420	1,00
HM 112 T4/T8 5,5/1,1kW (A6:3) (°)	5,5/1,1	54,25	55,76	30.997,21	358,03	5,82	1420	1,00
HM 112 T4/T8 5,5/1,1kW (A6:3) (°)	5,5/1,1	52,66	54,65	27.306,06	330,01	4,88	1420	1,00
HM 112 T4/T8 7,5/1,5kW (A6:3) (°)	7,5/1,5	53,05	53,66	38.016,12	397,60	8,05	1420	1,00
HM 112 T4/T8 7,5/1,5kW (A6:3) (°)	7,5/1,5	54,90	55,97	34.623,10	381,96	6,82	1420	1,00
HM 112 T4/T8 11/3kW (A6:3) (°)	11/3	49,77	49,81	44.242,32	420,80	10,58	1420	1,00
HM 112 T4/T8 11/3kW (A6:3) (°)	11/3	51,95	52,16	41.611,52	412,38	9,32	1420	1,00
HM 112 T4/T8 11/3kW (A6:6) (°)	11/3	55,93	55,99	34.046,39	574,11	10,34	1420	1,00
HM 112 T4/T8 11/3kW (A6:6) (°)	11/3	54,88	55,27	30.082,65	539,13	8,72	1420	1,00
HM 112 T4/T8 15/3,5kW (A6:3) (°)	15/3,5	45,05	44,90	49.204,26	432,78	13,44	1420	1,00
HM 112 T4/T8 15/3,5kW (A6:3) (°)	15/3,5	47,99	47,94	46.861,26	428,16	11,84	1420	1,00
HM 112 T4/T8 15/3,5kW (A6:3) (°)	15/3,5	42,11	41,87	51.227,83	432,64	15,09	1420	1,00
HM 112 T4/T8 15/3,5kW (A6:6) (°)	15/3,5	56,60	56,43	42.073,29	625,95	13,77	1420	1,00
HM 112 T4/T8 15/3,5kW (A6:6) (°)	15/3,5	56,68	56,62	37.975,26	606,49	12	1420	1,00
HM 112 T4/T8 15/3,5kW (A6:6) (°)	15/3,5	56,36	56,09	46.246,85	646,55	15,69	1420	1,00
HM 112 T4/T8 17/4,3kW (A6:3) (°)	17/4,3	39,21	38,89	53.213,23	431,91	16,92	1420	1,00
HM 112 T4/T8 17/4,3kW (A6:6) (°)	17/4,3	55,23	54,87	49.777,71	670,80	17,71	1420	1,00
HM 112 T4/T8 20/5kW (A6:6) (°)	20/5	54,11	53,66	53.425,81	693,47	19,83	1420	1,00
HM 112 T4/T8 28/6,5kW (A6:6) (°)	28/6,5	47,93	47,23	63.563,76	719,57	27,13	1420	1,00
HM 112 T4/T8 28/6,5kW (A6:6) (°)	28/6,5	50,27	49,65	60.259,07	714,30	24,46	1420	1,00
HM 112 T4/T8 28/6,5kW (A6:6) (°)	28/6,5	52,42	51,89	56.927	709,72	22,10	1420	1,00
HM 112 T4/T8 35/8kW (A6:6) (°)	35/8	45,08	44,31	66.879,03	709,13	29,95	1420	1,00
HM 125 T4/T8 11/3kW (A7:4) (°)	11/3	52,76	52,77	41.381,22	490,92	11,07	1420	1,00
HM 125 T4/T8 15/3,5kW (A7:4) (°)	15/3,5	54,08	53,97	46.299,44	524,29	12,87	1420	1,00



Model	Motor power (kW)	Maximum efficiency point data						
		Max. efficiency (%)	Efficiency grade (N) (N)	Air Flow (m3/h)	Ps (Pa)	Pabs (kW)	speed (rpm)	Specific ratio
HM 125 T4/T8 15/3,5kW (A7:4) (°)	15/3,5	53,91	53,68	51.353,96	552,14	15,01	1420	1,00
HM 125 T4/T8 15/3,5kW (A7:8) (°)	15/3,5	52,26	51,99	39.157,13	716,62	15,77	1420	1,00
HM 125 T4/T8 17/4,3kW (A7:4) (°)	17/4,3	53,91	53,56	56.643,01	578,72	17,27	1420	1,00
HM 125 T4/T8 20/5kW (A7:4) (°)	20/5	52,29	51,84	60.854,33	594,58	19,69	1420	1,00
HM 125 T4/T8 20/5kW (A7:8) (°)	20/5	53,09	52,68	44.346,10	765,42	18,80	1420	1,00
HM 125 T4/T8 28/6,5kW (A7:4) (°)	28/6,5	45,11	44,38	72.444,23	614,48	28,19	1420	1,00
HM 125 T4/T8 28/6,5kW (A7:4) (°)	28/6,5	48,16	47,52	68.749,63	620,53	25,10	1420	1,00
HM 125 T4/T8 28/6,5kW (A7:4) (°)	28/6,5	50,53	49,99	65.025,18	610,99	22,31	1420	1,00
HM 125 T4/T8 28/6,5kW (A7:8) (°)	28/6,5	54,82	54,18	56.057,61	847,78	25,48	1420	1,00
HM 125 T4/T8 28/6,5kW (A7:8) (°)	28/6,5	53,73	53,20	49.919,85	809,99	22,10	1420	1,00
HM 125 T4/T8 35/8kW (A7:8) (°)	35/8	54,34	53,49	67.473,87	910,36	33,08	1420	1,00
HM 125 T4/T8 35/8kW (A7:8) (°)	35/8	55,29	54,54	62.225,48	888,81	29,39	1420	1,00
HM 125 T4/T8 37/9,2kW (A7:8) (°)	37/9,2	53,08	52,14	72.689,59	929,84	37,24	1420	1,00
HM 125 T4/T8 44/11kW (A7:8) (°)	44/11	51,54	50,52	77.693,38	950,51	41,53	1420	1,00